



DC COMPONENTS CO., LTD.
RECTIFIER SPECIALISTS

RGL1A
THRU
RGL1M

TECHNICAL SPECIFICATIONS OF SURFACE MOUNT FAST RECOVERY RECTIFIER
VOLATGE RANGE - 50 to 1000 Volts **CURRENT - 1.0 Ampere**

FEATURES

- * Ideal for surface mounted applications
- * Low leakage current
- * Fast switching
- * Glass passivated junction

MECHANICAL DATA

- * Case: Molded plastic
- * Epoxy: UL 94V-0 rate flame retardant
- *Terminals: Solder plated solderable per MIL-STD-202E, Method 208 guaranteed
- * Polarity: Color band denotes cathode end
- * Mounting position: Any
- * Weight: 0.036 gram

MAXIMUM RATINGS AND ELECTRICAL CHARACTERISTICS

Ratings at 25 °C ambient temperature unless otherwise specified.
Single phase, half wave, 60 Hz, resistive or inductive load.
For capacitive load, derate current by 20%.



SM-2(DO-213AA)

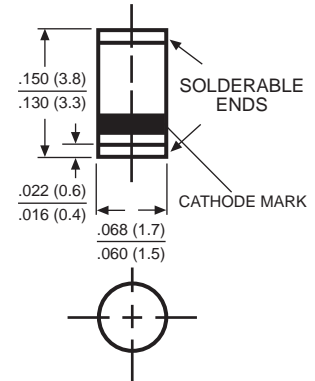

Dimensions in inches and (millimeters)

	SYMBOL	RGL1A	RGL1B	RGL1D	RGL1G	RGL1J	RGL1K	RGL1M	UNITS
Maximum Recurrent Peak Reverse Voltage	VRRM	50	100	200	400	600	800	1000	Volts
Maximum RMS Voltage	VRMS	35	70	140	280	420	560	700	Volts
Maximum DC Blocking Voltage	Vbc	50	100	200	400	600	800	1000	Volts
Maximum Average Forward Rectified Current TA = 55°C	Io	1.0							Amps
Peak Forward Surge Current IFM (surge): 8.3 ms single half sine-wave superimposed on rated load (JEDEC Method)	IFSM	10							Amps
Maximum Forward Voltage at 0.5A DC	VF	1.3							Volts
Maximum DC Reverse Current at	IR	5.0							µAmps
Rated DC Blocking Voltage		100							
Maximum Reverse Recovery Time (Note 3)	ttr	150			250	500	nSec		
Maximum Thermal Resistance (Note 2)	RθJ	70							°C/W
Typical Junction Capacitance (Note 1)	C	4.0							pF
Operating and Storage Temperature Range	TJ, TSTG	-50 to +150							°C

- NOTES : 1. Measured at 1.0 MHz and applied reverse voltage of 4.0VDC
 2. Thermal resistance (Junction to Ambient) .24in² (6.0mm²) copper pads to each terminal.
 3. Test Conditions: IF = 0.5A, IR=1.0A, IRR=0.25A

RATING AND CHARACTERISTIC CURVES (RGL1A THRU RGL1M)

FIG. 1 - TYPICAL FORWARD CURRENT DERATING CURVE

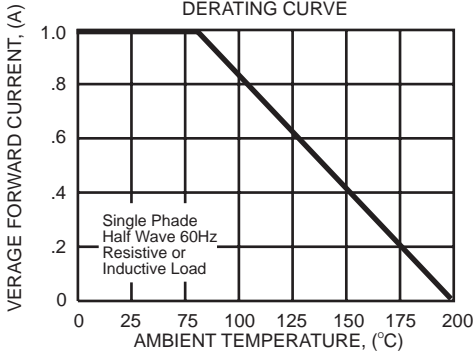

FIG. 2 - MAXIMUM NON-REPETITIVE FORWARD SURGE CURRENT

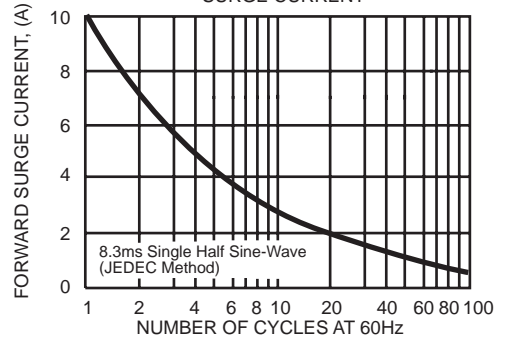

FIG. 3 - TYPICAL REVERSE CHARACTERISTICS

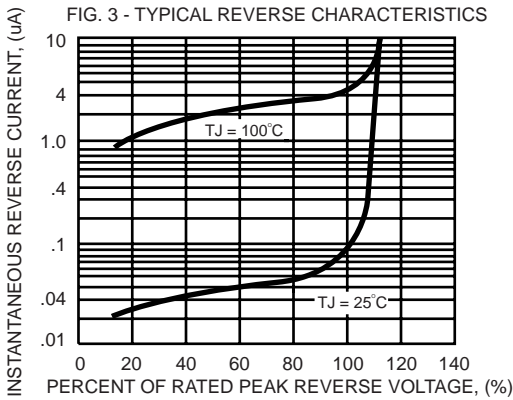

FIG. 4 - TYPICAL INSTANTANEOUS FORWARD CHARACTERISTICS

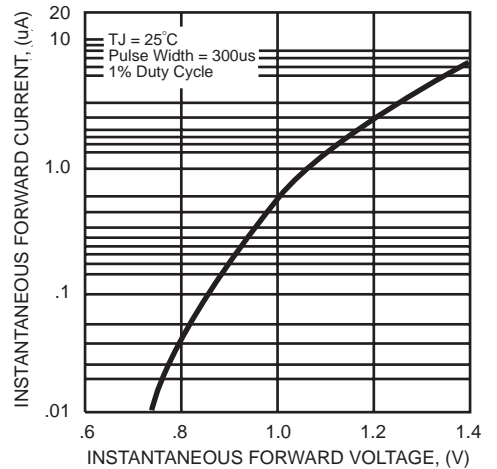
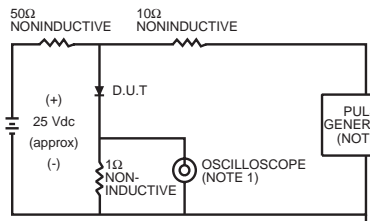

FIG. 5 - TEST CIRCUIT DIAGRAM AND REVERSE RECOVERY TIME CHARACTERISTICS



- NOTES:
1. Rise Time = 7ns max. Input Impedance = 1 megohm, 22 pF.
 2. Rise Time = 10ns max. Source Impedance = 50 ohms.

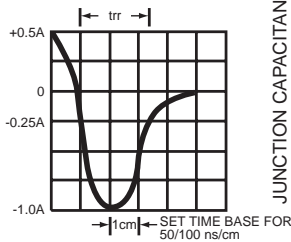
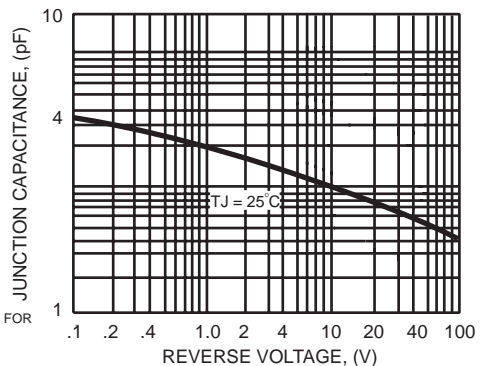

FIG. 6 - TYPICAL JUNCTION CAPACITANCE



DC COMPONENTS CO., LTD.