

Specification of DO-35 NTC Thermistor

PART NUMBER: **TT-DO-100KC3-5**

No. of pages: 1

Date: **20.02.2019**

Revision: **00**

FEATURES:

Element	DO-35 NTC Thermistor
No-load resistance at 25°C	100 000 Ω
Tolerance at 25°C	± 1%
Beta (25/85) Constant	3 960K ±1%
Operating temperature range	-40°C ÷ 250°C

DRAWING:

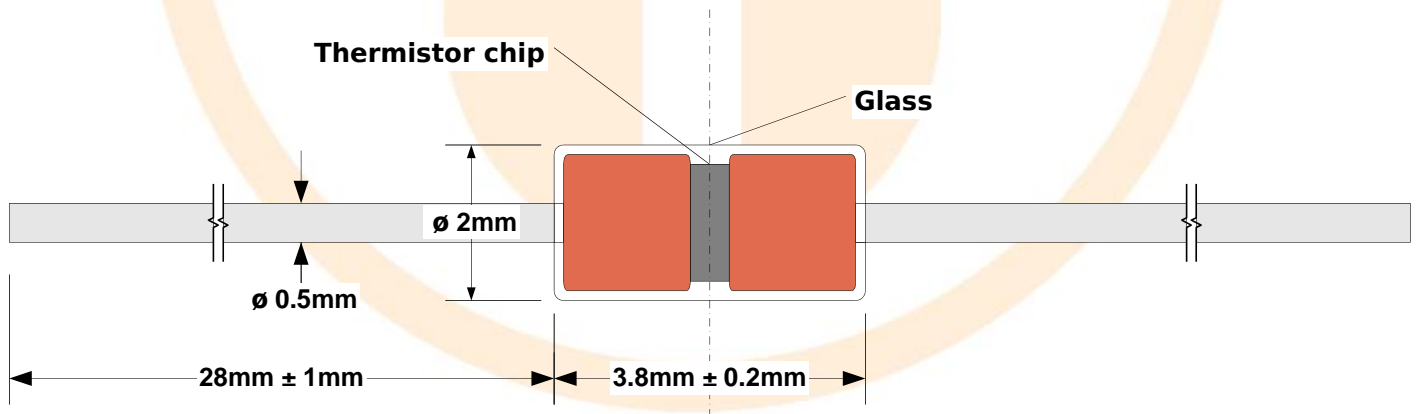

UNITS: [mm]