



**Combination knobs,
Disk, Nut cover**

- Black, RAL 9005
- Dust grey, RAL 7037

Covers

(depends on size/type)

- Black, RAL 9005
- Red, RAL F12/0-10
- Yellow, RAL F12/0-1
- Green, RAL F12/0-43
- Blue, RAL 5012
- Pebble grey, RAL 7032
- Dust grey, RAL 7037

Arrow disk

- Black, RAL 9005
- Red, RAL F12/0-10
- Dust grey, RAL 7037

Dial

- Transparent, bright surface
- with/without symbols

Stator

- Aluminium,
- marking black

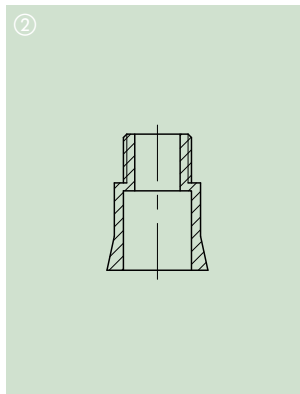
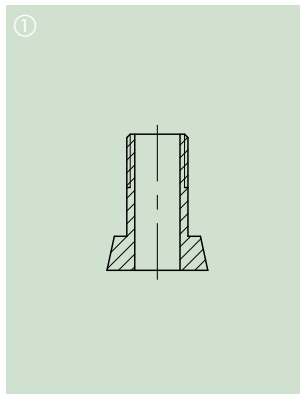
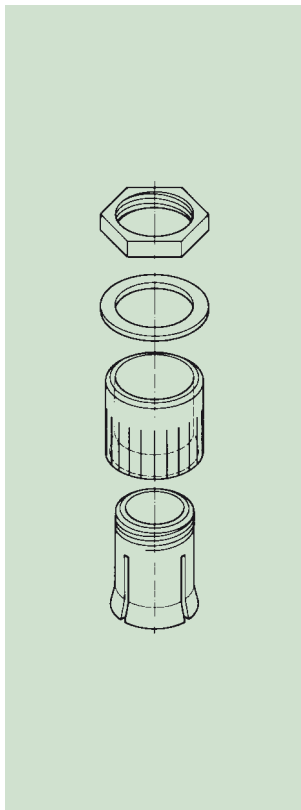

THE PRODUCT

The name COMBINATION KNOBS stands for an exceedingly functional range of rotary buttons with a reliable collet fixture system. They offer a versatile range of possible applications as round knobs, wing knobs and spindle-shaped knobs with a large selection of accessories.

APPLICATIONS

Well-proven for electro-mechanical rotary potentiometers with shaft ends corresponding to DIN 41 591. Measuring and control technology, heating and air conditioning.

YOUR ADVANTAGE

Tried and tested collet fixture system. Convenient assembly of knobs from the front, easy adjusting (by means of an adjusting key – see accessory page 18). Tight fitting of knobs on the axis. Sizes 10 and 13 have blind holes and screw fixing. From knob size 23 up, through holes ① (sizes 16 + 20 steppt ②, except for axes 4 mm).

Round, wing and spindle-shaped knobs with the same standardized design and with matt surface.

A large variety of functional accessories, e.g. covers in seven colours and transparent dials. Easy push-on assembly.

We also produce our COMBINATION KNOBS in special colours, moq reserved. Please advise us of the colour and quantity you require.

MATERIAL

Knobs, covers, arrow disks and nut covers: ABS (UL 94 HB).

Dials: Polycarbonate.

Stator: Al-sheet 0.5 mm



with self-adhesive film.

Please refer to specifications on page 29.

COMBINATION KNOBS



TYPES

Knob ø	Torque (Nm)		ROUND KNOB		WING KNOB		SPINDLE-SHAPED KNOB	
	assembly	function	borehole		borehole		borehole	
9	0.4	0.4	4 mm					
10	0.4	0.4	3 mm					
	0.4	0.4	4 mm					
	0.4	0.4	1/8"					
13.5	0.5	0.5	4 mm					
	0.7	0.6	6 mm		6 mm			
16	0.5	0.5	–				3 mm	
	0.6	0.5	4 mm		–			
	0.8	0.7	6 mm		6 mm			
	0.8	0.7	1/4"		–			
20	0.8	0.7	4 mm					
	1.0	0.9	6 mm					
	1.0	0.9	1/4"					
23	1.0	0.8	4 mm				4 mm	
	1.2	1.0	6 mm					
	1.2	1.0	1/4"					
31	1.8	1.6	6 mm				6 mm	
	1.8	1.6	1/4"					
40	2.5	1.6	6 mm				6 mm	
	2.8	1.8	8 mm					
50	3.0	1.8	6 mm					
	3.5	2.0	8 mm					

COMBINATION KNOBS

ROUND KNOB
WING KNOB
SPINDLE-SHAPED KNOB
COVER

...100 = indicator line white, otherwise in black

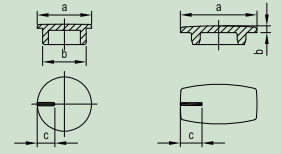

Knob ø	Shape	Borehole D	Cover				without indicator line		with indicator line	
			Black	White	Grey	White	Black	White	Black	White
9	 ROUND KNOB	4 mm, with chamfer		A 26 09 040			a = 8.0 b = 6.5 c = 2.6		A 41 10 000	A 41 10 100
						A 41 10 002			A 41 10 102	
10	 ROUND KNOB	3 mm, with chamfer	A 25 10 030	A 26 10 030	A 25 10 038	A 26 10 038			A 41 10 004	A 41 10 104
		1/8", with chamfer	A 25 10 320	A 26 10 320					A 41 10 006	A 41 10 106
		4 mm, with chamfer	A 25 10 040	A 26 10 040	A 25 10 048	A 26 10 048			A 41 10 007	
13.5	 ROUND KNOB	4 mm, with chamfer	A 25 13 040	A 26 13 040	A 25 13 048	A 26 13 048	a = 11.2 b = 9.2 c = 3.0		A 41 13 000	A 41 13 100
		6 mm, with chamfer	A 25 13 060	A 26 13 060	A 25 13 068	A 26 13 068			A 41 13 002	A 41 13 102
	 WING KNOB	6 mm, with chamfer		A 28 13 060					A 41 13 004	A 41 13 104
16	 ROUND KNOB	4 mm, without chamfer	A 25 16 040	A 26 16 040			a = 13.5 b = 11.2 c = 4.0		A 41 16 000	A 41 16 100
		6 mm, with chamfer	A 25 16 060	A 26 16 060	A 25 16 068	A 26 16 068			A 41 16 002	A 41 16 102
		1/4", with chamfer	A 25 16 630	A 26 16 630	A 25 16 638				A 41 16 004	
	 WING KNOB	6 mm, with chamfer		A 28 16 060					A 41 16 005	A 41 16 105
	 SPINDLE-SHAPED KNOB	3 mm, with chamfer		A 24 16 030			a = 14.0 b = 1.2 c = 4.0		A 50 16 000	A 50 16 100
		4 mm, with chamfer	A 23 16 040	A 24 16 040		A 24 16 048				A 50 16 108

COMBINATION KNOBS

ARROW DISK

DISK

DIAL

STATOR

NUT COVER

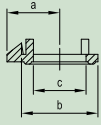

...010 = indicator line white

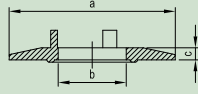

...0 = symbols black
...9 = symbols silver

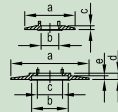

indicator line black

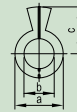

...010 = indicator line white
...018 = indicator line black

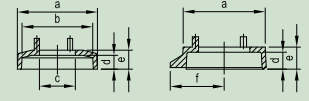

a = 7.0
b = 10.1
c = 7.0



A 42 10 000



A 42 10 002



A 42 10 008

a = 20.0
b = 7.0
c = 1.5



A 44 10 060

(only for knob ø 10)

a = 15.5
b = 14.0
c = 7.0
d = 2.9
e = 3.7



A 75 10 000



A 75 10 010

A 75 10 018

(only for knob ø 10)

a = 9.0
b = 13.6
c = 8.0



A 42 13 000



A 42 13 002



A 42 13 008

a = 26.0
b = 8.0
c = 1.5



A 44 13 010



A 44 13 020



A 44 13 049



A 44 13 060

a = 17.5
b = 15.7
c = 9.0
d = 3.2
e = 4.3



A 75 13 000



A 75 13 010

A 75 13 018

a = 10.5
b = 16.3
c = 10.0



A 42 16 000



A 42 16 002



A 42 16 008

a = 23.0
b = 10.0
c = 1.3



A 73 16 000

A 73 16 010

a = 31.0
b = 14.5
c = 10.0
d = 2.5
e = 1.7



A 44 16 001



A 44 16 010



A 44 16 020



A 44 16 060

(ø 16 with moulded-on nut cover)

a=16.0
b=10.1
c=15.5

A 60 16 019

a = 19.3
b = 17.6
c = 10.0
d = 3.3
e = 4.3



A 75 16 000



A 75 16 010

A 75 16 018

a = 16.4
b = 14.6
c = 10.0
d = 3.3
e = 4.3
f = 10.2



A 76 16 000



A 76 16 008

a = 16.0
b = 14.8
c = 8.3
d = 3.3
e = 4.3



A 51 16 000

ROUND KNOB
WING KNOB
SPINDLE-SHAPED KNOB
COVER

...100 = indication line white, otherwise in black

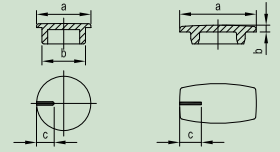

Knob Ø	Shape	Borehole D	Cover				without indication line		with indication line	
			Black	White	Grey	White	Black	White	Black	White
20	ROUND KNOB 	4 mm, without chamfer 6 mm, with chamfer 1/4", with chamfer	A 25 20 040	A 26 20 040	A 25 20 068	A 26 20 068	a = 17.5 b = 15.2 c = 5.5		A 41 20 000	A 41 20 100
			A 25 20 060	A 26 20 060					A 41 20 002	A 41 20 102
			A 25 20 630	A 41 20 005					A 41 20 104	
23	ROUND KNOB 	4 mm, without chamfer 6 mm, without chamfer 1/4", without chamfer	A 25 23 040	A 26 23 040	A 25 23 068	A 26 23 068	a = 20.4 b = 17.4 c = 6.5		A 41 23 000	A 41 23 100
			A 25 23 060	A 26 23 060					A 41 23 002	A 41 23 102
			A 25 23 630	A 41 23 004					A 41 23 105	
									A 41 23 106	A 41 23 106
									A 41 23 107	A 41 23 107
									A 41 23 108	A 41 23 108
31	SPINDLE-SHAPED KNOB 	4 mm, with chamfer 6 mm, with chamfer	A 24 23 040	A 24 23 060	A 24 23 068	A 24 23 068	a = 20.9 b = 1.2 c = 6.5		A 50 23 000	A 50 23 100
			A 24 23 060	A 50 23 008					A 50 23 108	
31	ROUND KNOB 	6 mm, without chamfer 1/4", without chamfer	A 25 31 060	A 26 31 060	A 25 31 068	A 26 31 068	a = 28.4 b = 26.0 c = 9.0		A 41 31 000	A 41 31 100
			A 25 31 630	A 41 31 002					A 41 31 102	
				A 41 31 005					A 41 31 105	
								A 41 31 006	A 41 31 106	
								A 41 31 007	A 41 31 107	
								A 41 31 008	A 41 31 108	
31	SPINDLE-SHAPED KNOB 	6 mm, with chamfer	A 24 31 060	A 24 31 068	A 24 31 068	A 24 31 068	a = 29.0 b = 1.4 c = 9.5		A 50 31 000	A 50 31 100
									A 50 31 107	
									A 50 31 108	

COMBINATION KNOBS

ARROW DISK		DISK		DIAL		STATOR		NUT COVER	
		...010 = indication line white 		...0 = symbols black ...9 = symbols silver 		indication line black 			
a = 13.0 b = 20.0 c = 12.0	A 42 20 000 A 42 20 002 A 42 20 008			a = 36.0 b = 12.0 c = 1.5	A 44 20 001 A 44 20 010 A 44 20 060	a=20.0 b=10.1 c=18.0	A 60 20 019		
a = 14.3 b = 23.0 c = 16.5	A 42 23 000 A 42 23 002 A 42 23 008	a = 31.0 b = 16.5 c = 1.3	A 73 23 010	a = 40.0 b = 16.3 c = 1.3	A 44 23 010 A 44 23 020 A 44 23 039 A 44 23 060	a=23.0 b=10.2 c=20.0	A 60 23 019		
								a = 23.3 b = 20.0 c = 13.7 d = 3.3 e = 4.3	A 51 23 000 A 51 23 008
a = 19.5 b = 31.0 c = 16.5	A 42 31 000 A 42 31 002 A 42 31 008	a = 40.0 b = 16.5 c = 1.6	A 73 31 000 A 73 31 010	a = 49.9 b = 16.5 c = 1.5	A 44 31 010 A 44 31 060				
								a = 31.1 b = 28.0 c = 15.5 d = 3.3 e = 4.8	A 51 31 000 A 51 31 008







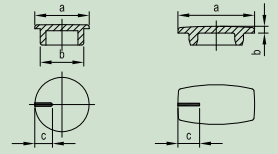

COMBINATION KNOBS

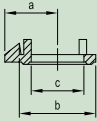
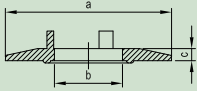
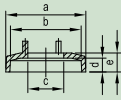
ROUND KNOB
SPINDLE-SHAPED KNOB
COVER

...100 = indication line white, otherwise in black



Knob ∅	Shape	Borehole D	Cover				without indication line		with indication line	
			Black	Black with line	Grey	Grey with line				
40	ROUND KNOB 	6 mm, without chamfer 8 mm, without chamfer	A 25 40 060	A 26 40 060	A 25 40 068	A 26 40 068	a = 37.4 b = 34.4 c = 12.5	A 41 40 000 A 41 40 002 A 41 40 007 A 41 40 008		
	SPINDLE-SHAPED KNOB 	6 mm, with chamfer		A 24 40 060		A 24 40 068	a = 37.9 b = 1.6 c = 13.0	A 50 40 000 A 50 40 008		
50	ROUND KNOB 	6 mm, without chamfer	A 25 50 060	A 26 50 060	A 25 50 068		a = 47.4 b = 44.4 c = 14.5	A 41 50 000 A 41 50 008		A 41 50 100 A 41 50 107

ARROW DISK		DISK		DIAL		STATOR		NUT COVER	
		<p>...010 = indication line white</p> 							
		 						 	
<p>a = 24.5 b = 40.0 c = 25.0</p>  	<p>A 42 40 000</p> <hr/> <p>A 42 40 008</p>	<p>a = 50.1 b = 24.0 c = 1.8</p> 	<p>A 73 40 010</p>					<p>a = 40.3 b = 36.8 c = 20.0 d = 3.1 e = 4.6</p> 	<p>A 51 40 000</p>

FOR ROUND KNOBS / WING KNOBS / SPINDLE-SHAPED KNOBS / COM-KNOBS

Part-No.	Article	Version / Application	Dim. in mm	Picture
A 61 16 010	Locking device with stator	For round knobs and wing knobs size 16 with dial only. Transparent, marking black.		
A 61 00 000	Locking device	For universal use of round knobs, wing knobs and COM-KNOBS with dial.		
Round knobs ϕ D ₁ D ₂ D ₃	Adjusting key	For correct adjusting of combination knobs (round knobs) with indicator line, dial and arrow disk. Knob mounting without difficulties.		
A 64 02 005	10 13.5 16			
A 64 03 005	20 23 31			
G ϕ	Round nut	For mounting of potentiometer at front panels. It fits under knob and nut cover (round knobs / wing knobs / spindle-shaped knobs / COM-KNOBS ϕ 10 / 13.5 / 16 / 20 / 23 / 31 / 40 / 50).		
A 62 07 009	M 7 x 0.75 13.5			
A 62 10 009	M 10 x 0.75 12.5			
A 62 95 009	3/8" - 32G 12.5			
A 63 00 000	Spanner	For tightening round nuts.		
Bore	Torsion protection	For torsion-proved mounting of knobs on profiled axes 6 / 4.6 mm. Suitable for round and wing knobs sizes ϕ 20 to 50 with 6 mm borehole (not suitable for COM-KNOBS).		
A 66 00 064	6 / 4.6			