

### Kondensatory samochodowe zapłonowe Ignition capacitors

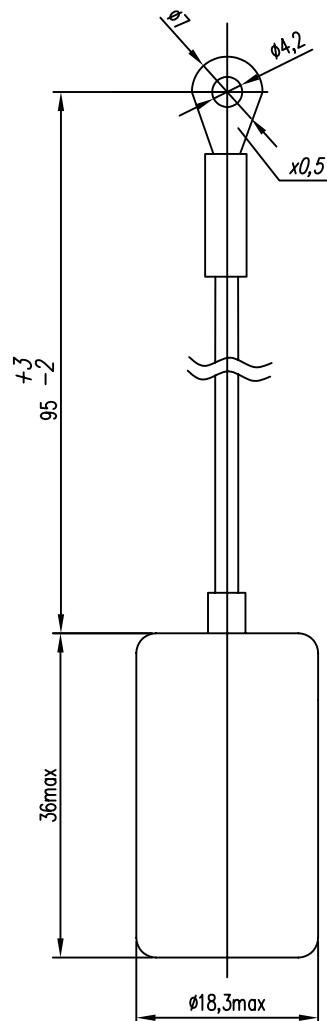

#### TECHNICAL DATA:

Non-inductive KPs capacitors are designed to work in ignition devices for internal combustion engines.

Temperature working range	-40 ÷ +100°C
Rated capacitance (Cr)	0,25µF
Capacitance tolerance	±10%
Rated voltage (Ur) at 50Hz	500V~
Test voltage (Up) at 50Hz	750V~ 1min.
Insulation resistance (Rinsul) at 20°C	≥5000MΩ
Weight	~27g
Specification	WT-04/MIFLEX/KPs

 **MIFLEX S.A.**

ZAKŁADY PODZESPOŁÓW RADIOWYCH  
99-300 KUTNO, UL. GRUNWALDZKA 3 POLAND  
Chief Engineering Specialist +48 24 355 12 10  
Design Department +48 24 355 12 77  
Production Engineering Department +48 24 355 12 77  
Fax +48 24 355 12 88  
E-mail miflexsa@miflex.com.pl

Strona 1/1  
(Seite/Page)

Data aktualizacji: 14.12.2016.  
(Letzte Aktualisierung/Revision date)