

KEMET Part Number: PME261JA4100KR19T0
(P561HE102K500L)

PME261/P561, Film, Metallized Paper, General Purpose, 1000 pF, 10%, 1000 VDC, 85C, Lead Spacing = 10.2mm

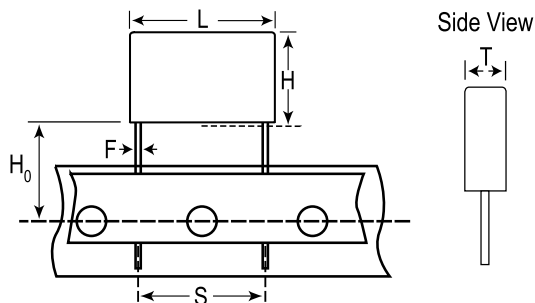

General Information	
Supplier:	KEMET
Series:	PME261/P561
Dielectric:	Metallized Paper
Style:	Radial
Features:	Pulse in DC and low frequency applications
RoHS:	Yes
Lead:	Wire Leads
Construction:	Molded
Miscellaneous:	AC Operation: 70C MAX

Dimensions	
L	13.5mm MAX
H	7.5mm MAX
T	3.9mm MAX
S	10.2mm +0.6/-0.1mm
H0	18.5mm +/-0.5mm
F	0.6mm +/-0.05mm

Specifications	
Capacitance:	1000 pF
Capacitance Tolerance:	10%
Voltage AC:	500 VAC
Voltage DC:	1000 VDC
Temperature Range:	-40/+100C
Rated Temperature:	85C
Dissipation Factor:	1.30% 1kHz
Insulation Resistance:	12 GOhms
Max dV/dt:	2000 V/us

Packaging Specifications	
Packaging:	T&R
Packaging Quantity:	700