

Capacitor, Film, Film-Foil Polypropylene, 1500 pF, +/-5% Tol, -55/+105C, General Purpose, 1600 VDC@85C, Lead Spacing=15 mm

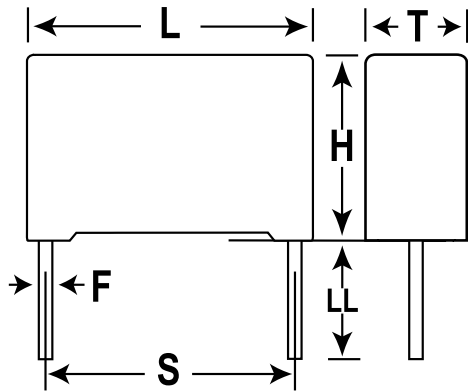

General Information	
Supplier:	KEMET
Dielectric:	Film-Foil Polypropylene
Application:	General Purpose
Sub Application:	AEC-Q200
Style:	Radial Box
Lead Form:	Wire Leads
Features:	Pulse
Approvals:	AEC-Q200
RoHS:	Yes

Dimensions (mm)		
Symbol	Dimension	Tolerance
L	18	+0.3
H	11	+0.1
T	5	+0.2
S	15	+/-0.4
LL	30	+5
F	0.8	+/-0.05

Specifications	
Capacitance:	1500 pF
Voltage:	1600 VDC
Tolerance:	+/-5%
Voltage AC:	450 VAC
Rated Temperature:	85C
Temperature Range:	-55/+105C
Dissipation Factor @ 1 kHz:	0.03%
Dissipation Factor @ 10 kHz:	0.04%
Dissipation Factor @ 100kHz:	0.1%
Insulation Resistance:	100 GOhm
Inductance:	10
Maximum dVdT:	34000 v/us
Miscellaneous:	Above 85C DC And AC Voltage Derating Is 1.25%/C

Packaging Specifications	
Package Kind:	Bulk
Package Quantity:	1000