

Capacitor, Film, Metallized Polypropylene, 0.01 uF, +/-20% Tol, -40/+110C, Safety: X2, 275 VAC, Lead Spacing=15 mm

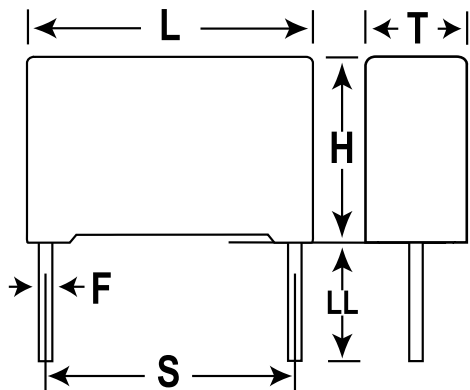

General Information	
Supplier:	KEMET
Dielectric:	Metallized Polypropylene
Application:	Safety: X2
Style:	Radial Box
Lead Form:	cut
Features:	Pulse
Approvals:	ENEC,UL,cUL,CQC
RoHS:	Yes

Dimensions (mm)		
Symbol	Dimension	Tolerance
L	18	+0.3
H	11	+0.1
T	5	+0.2
S	15	+/-0.4
LL	4	+2
F	0.6	+/-0.05

Specifications	
Capacitance:	0.01 uF
Voltage:	560 VDC
Tolerance:	+/-20%
Voltage AC:	275 VAC
Rated Temperature:	110C
Temperature Range:	-40/+110C
Dissipation Factor @ 1 kHz:	0.1%
Insulation Resistance:	100 GOhm
Maximum dVdT:	400 v/us

Packaging Specifications	
Package Kind:	Bulk
Package Quantity:	2000