

**KEMET Part Number: PME271Y422MR19T0**  
(P271HE222M250L)

Capacitor, Film, Metallized Paper, 2200 pF, +/-20% Tol, -40/+100C, Safety: Y2, 250 VAC, Lead Spacing=10.2 mm

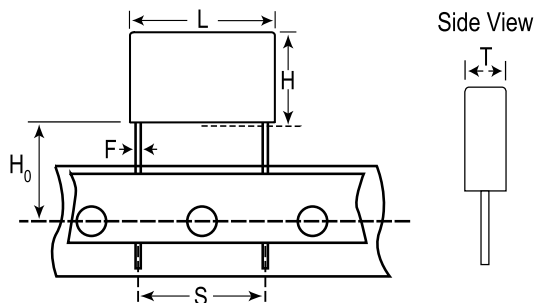

General Information	
Supplier:	KEMET
Dielectric:	Metallized Paper
Application:	Safety: Y2
Style:	Radial Molded
Lead Form:	Wire Leads
Features:	Pulse
Approvals:	ENEC,UL,cUL,CQC
RoHS:	Yes

Dimensions (mm)		
Symbol	Dimension	Tolerance
L	13.5	MAX
H	7.5	MAX
T	3.9	MAX
S	10.2	+/-0.4
F	0.6	+/-0.05
H0	18.5	+/-0.5

Specifications	
Capacitance:	2200 pF
Voltage:	1000 VDC
Tolerance:	+/-20%
Voltage AC:	250 VAC
Rated Temperature:	100C
Temperature Range:	-40/+100C
Dissipation Factor @ 1 kHz:	1.3%
Insulation Resistance:	12 GOhm
Maximum dVdT:	2000 v/us
Miscellaneous:	SRF= 37 MHz

Packaging Specifications	
Package Kind:	T&R
Package Size:	Standard
Package Quantity:	700