

KEMET Part Number: LDEPD1470KA5N00
(DEPD1470KA5N00)

Capacitor, Film, Metallized PEN (Stacked), 4700 pF, +/-10% Tol, General Purpose, 630 VDC@125C

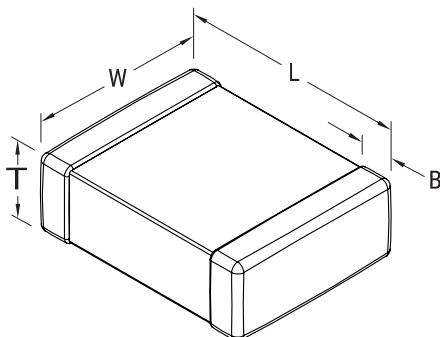

Dimensions (mm)		
Symbol	Dimension	Tolerance
L	6	+/-0.3
W	5	+/-0.4
T	2	MAX
B	0.5	+0.5/-0.3

Packaging Specifications	
Package Kind:	T&R
Package Size:	Standard
Package Quantity:	3000

General Information	
Supplier:	KEMET
Dielectric:	Metallized PEN (Stacked)
Application:	General Purpose
Sub Application:	AEC-Q200
Style:	Surface Mount
Chip Size:	2220 (5750 metric)
RoHS:	Yes

Specifications	
Capacitance:	4700 pF
Voltage:	630 VDC
Tolerance:	+/-10%
Voltage AC:	200 VAC
Rated Temperature:	125C
Temperature Range:	-55/+125C
Dissipation Factor @ 1 kHz:	0.8%
Insulation Resistance:	1 GOhm
Maximum dVdT:	100 v/us