

Capacitor, Aluminum, 330 uF, +/-20% Tol, 2 VDC@125C

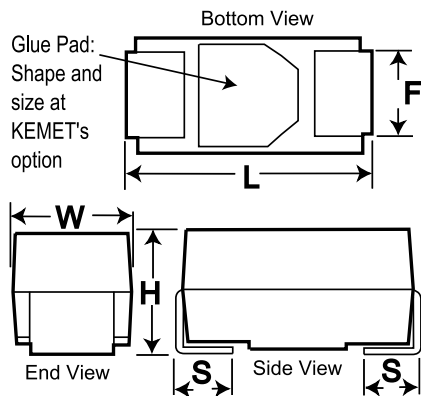

Dimensions (mm)		
Symbol	Dimension	Tolerance
L	7.3	+/-0.3
W	4.3	+/-0.3
H	2.8	+/-0.3
F	2.4	+/-0.1
S	1.3	+/-0.3

Notes:  
 -D/7343-31

General Information	
Supplier:	KEMET
Application:	125C Polymer
Part Type Description:	Surface Mount Polymer Aluminum
Termination:	Tin
Footprint:	7343
RoHS:	Yes

Specifications	
Capacitance:	330 uF
Voltage:	2 VDC
Tolerance:	+/-20%
Rated Temperature:	125C
Temperature Range:	-55/+125C
Leakage Current:	39.6 uA
Leakage Condition:	uAmps (5min 20C)
Dissipation Factor:	6%
Resistance/ESR:	7 mOhms (100kHz)
Current/Ripple Current:	6000 mAmps (100kHz)

Packaging Specifications	
Package Kind:	T&R
Package Size:	7 in/180 mm
Package Quantity:	500