

C900AH SFTY X1-400 Y1-400, Ceramic, 1000 pF, 20%, 400 VAC (X1), 400 VAC (Y1), Y5U, Lead Spacing = 10mm

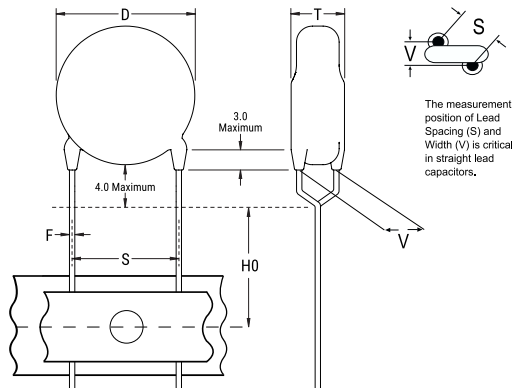

**Dimensions**

<b>D</b>	8mm MAX
<b>T</b>	5mm MAX
<b>S</b>	10mm +/-1mm
<b>H0</b>	18mm +2/-0mm
<b>F</b>	0.55mm +/-0.1mm

**Packaging Specifications**

<b>Packaging:</b>	Ammo
<b>Packaging Quantity:</b>	1000

**General Information**

<b>Supplier:</b>	KEMET
<b>Series:</b>	C900AH SFTY X1-400 Y1-400
<b>Style:</b>	Radial Disc
<b>RoHS:</b>	Yes
<b>Termination:</b>	Tin
<b>Failure Rate:</b>	N/A
<b>Qualifications:</b>	UL, ENEC, VDE, CSA, CAN
<b>Halogen Free:</b>	Yes

**Specifications**

<b>Capacitance:</b>	1000 pF
<b>Capacitance Tolerance:</b>	20%
<b>Voltage AC:</b>	400 VAC (X1), 400 VAC (Y1)
<b>Dielectric Withstanding Voltage:</b>	4000 VDC
<b>Temperature Range:</b>	-40/+125°C
<b>Temperature Coefficient:</b>	Y5U
<b>Dissipation Factor:</b>	2.50%
<b>Insulation Resistance:</b>	10 GOhms
<b>Safety Class:</b>	X1/Y1