

C900AH SFTY X1-400 Y1-400, Ceramic, 220 pF, 10%, 400 VAC (X1), 400 VAC (Y1), Y5P, Lead Spacing = 10mm

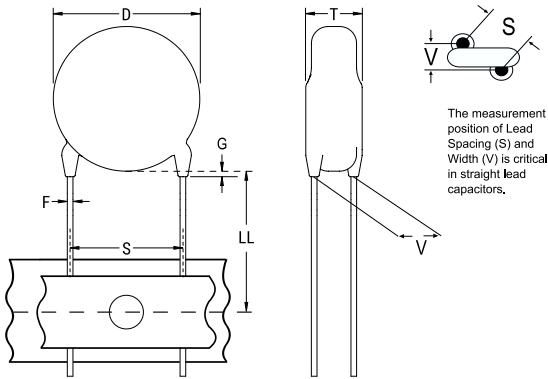

General Information	
Supplier:	KEMET
Series:	C900AH SFTY X1-400 Y1-400
Style:	Radial Disc
RoHS:	Yes
Termination:	Tin
Failure Rate:	N/A
Qualifications:	UL, ENEC, VDE, CSA, CAN
Halogen Free:	Yes

Dimensions	
D	7mm MAX
T	5mm MAX
S	10mm +/-1mm
LL	20mm +1.5/-1mm
F	0.55mm +/-0.1mm
G	3mm MAX

Specifications	
Capacitance:	220 pF
Capacitance Tolerance:	10%
Voltage AC:	400 VAC (X1), 400 VAC (Y1)
Dielectric Withstanding Voltage:	4000 VDC
Temperature Range:	-40/+125°C
Temperature Coefficient:	Y5P
Dissipation Factor:	2.50%
Insulation Resistance:	10 GOhms
Safety Class:	X1/Y1

Packaging Specifications	
Packaging:	Ammo
Packaging Quantity:	1000