

C900AC SFTY X1-440 Y2-300, Ceramic, 1000 pF, 20%, 440 VAC (X1), 300 VAC (Y2), Y5V, Lead Spacing = 10mm

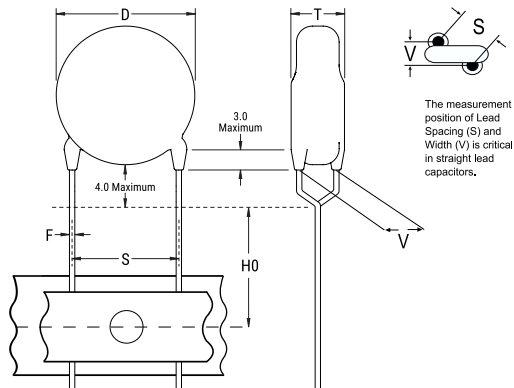

General Information	
Supplier:	KEMET
Series:	C900AC SFTY X1-440 Y2-300
Style:	Radial Disc
RoHS:	Yes
Termination:	Tin
Failure Rate:	N/A
Qualifications:	UL, ENEC, VDE, CSA, CAN
Halogen Free:	Yes

Dimensions	
D	7mm MAX
T	5mm MAX
S	10mm +/-1mm
H0	18mm +2/-0mm
F	0.55mm +/-0.1mm

Specifications	
Capacitance:	1000 pF
Capacitance Tolerance:	20%
Voltage AC:	440 VAC (X1), 300 VAC (Y2)
Dielectric Withstanding Voltage:	2600 VDC
Temperature Range:	-40/+125C
Temperature Coefficient:	Y5V
Dissipation Factor:	5.00%
Insulation Resistance:	10 GOhms
Safety Class:	X1/Y2

Packaging Specifications	
Packaging:	Ammo
Packaging Quantity:	1000

Statements of suitability for certain applications are based on our knowledge of typical operating conditions for such applications, but are not intended to constitute - and we specifically disclaim - any warranty concerning suitability for a specific customer application or use. This Information is intended for use only by customers who have the requisite experience and capability to determine the correct products for their application. Any technical advice inferred from this Information or otherwise provided by us with reference to the use of our products is given gratis, and we assume no obligation or liability for the advice given or results obtained.