

C900AC SFTY X1-400 Y2-250, Ceramic, 1000 pF, 20%, 400 VAC (X1), 250 VAC (Y2), Y5U, Lead Spacing = 10mm

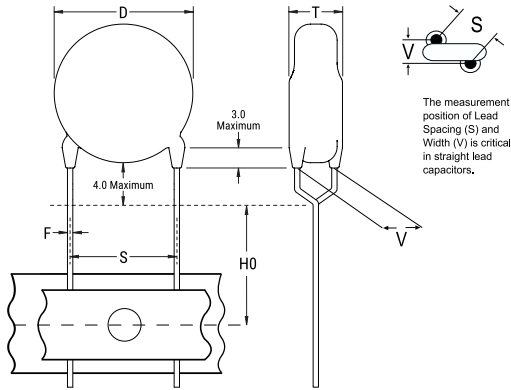

Dimensions

D	7mm MAX
T	5mm MAX
S	10mm +/-1mm
H0	18mm +2/-0mm
F	0.55mm +/-0.1mm

Packaging Specifications

Packaging:	Ammo
Packaging Quantity:	1000

General Information

Supplier:	KEMET
Series:	C900AC SFTY X1-400 Y2-250
Style:	Radial Disc
RoHS:	Yes
Termination:	Tin
Failure Rate:	N/A
Qualifications:	UL, ENEC, VDE, CSA, CAN
Halogen Free:	Yes

Specifications

Capacitance:	1000 pF
Capacitance Tolerance:	20%
Voltage AC:	400 VAC (X1), 250 VAC (Y2)
Dielectric Withstanding Voltage:	2600 VDC
Temperature Range:	-40/+125C
Temperature Coefficient:	Y5U
Dissipation Factor:	2.50%
Insulation Resistance:	10 GOhms
Safety Class:	X1/Y2