

Film, Metallized Polypropylene, DC Link, C44U, 225 uF, 10%, 700 V

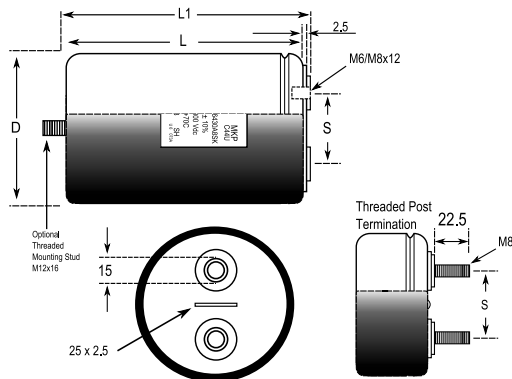

General Information	
Dielectric:	Metallized Polypropylene
Style:	Can
Series:	C44U
Features:	Heavy Duty
RoHS:	Yes
Lead:	Screw Terminals M6
Miscellaneous:	Thermal Resistance = 7.2 C/W. Weight = 414 grams

Dimensions	
D	85mm +/-1mm
L	70mm +/-2mm
S	31.7mm +/-0.2mm

Specifications	
Capacitance:	225 uF
Capacitance Tolerance:	10%
Voltage DC:	700 VDC
Temperature Range:	-40/+85C
Rated Temperature:	75C
Max dVdt:	14 V
Resistance:	1.2 mOhms (10kHz)
Current:	70 Amps (10kHz 40C), 3150 Amps (Peak)
Inductance:	40 nH

Packaging Specifications	
Mounting:	Bolt - M12x16
Packaging:	Bulk
Packaging Quantity:	10

Statements of suitability for certain applications are based on our knowledge of typical operating conditions for such applications, but are not intended to constitute - and we specifically disclaim - any warranty concerning suitability for a specific customer application or use. This Information is intended for use only by customers who have the requisite experience and capability to determine the correct products for their application. Any technical advice inferred from this Information or otherwise provided by us with reference to the use of our products is given gratis, and we assume no obligation or liability for the advice given or results obtained.