

# W 130 S - 8 Ohm

Art. No. 9023



**13 cm (5") HiFi Tiefmitteltöner** mit beschichteter Papiermembran, elastischer Gummisicke und 25-mm-Schwingspule. Einsetzbar als Tieftöner und durch sehr ausgeglichenen Frequenzgang auch als Tiefmitteltöner in größeren 3-Wege-Boxen.

**13 cm (5") HiFi low-midrange driver** with coated paper cone, elastic rubber surround and 25 mm voice-coil. Suitable as woofer and due to the very balanced frequency response also as low-midrange driver especially in large 3-way speaker systems.

## Gehäuseempfehlungen / Recommended cabinets

Volumen/Prinzip	BR-Rohr	$f_b$	$f_c/Q_{TC}$
7 l/geschlossen	-	-	86 Hz/0,77
20 l/Bassreflex	BR 6.8 (4 cm lang)	44 Hz	-
30 l/Bassreflex	BR 19.24 (12 cm lang)	39 Hz	-

Volume/Principle	BR-Channel	$f_b$	$f_c/Q_{TC}$
7 l/closed	-	-	86 Hz/0,77
20 l/bass reflex	BR 6.8 (length 4 cm)	44 Hz	-
30 l/bass reflex	BR 19.24 (length 12 cm)	39 Hz	-

15.03.2013

# W 130 S - 8 Ohm

Art. No. 9023

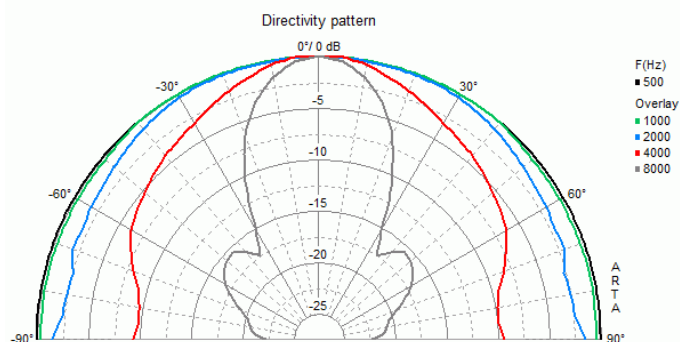
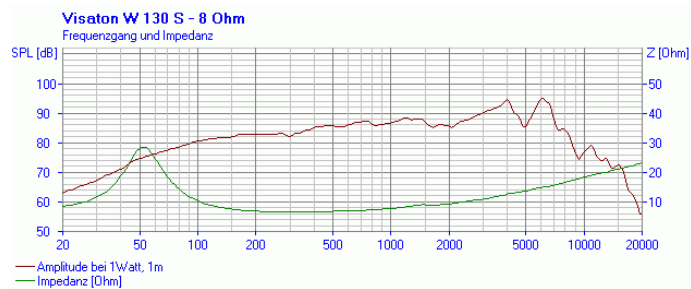
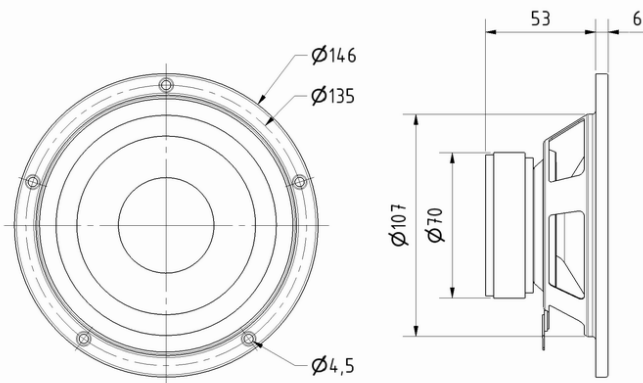

## Technische Daten / Technical data

Nennbelastbarkeit Rated power	50 W
Musikbelastbarkeit Maximum power	80 W
Nennimpedanz Z Nominal impedance Z	8 Ohm
Übertragungsbereich Frequency response	fu-12000 Hz
(fu: untere Grenzfrequenz abhängig vom Gehäuse) (fu: Lower cut-off frequency depending on cabinet)	.
Mittlerer Schalldruckpegel Mean sound pressure level	87 dB (1 W/1 m)
Abstrahlwinkel (-6 dB) Opening angle (-6 dB)	113°/4000 Hz
Grenzauslenkung Excursion limit	+/-8 mm
Resonanzfrequenz fs Resonance frequency fs	52 Hz
Magnetische Induktion Magnetic induction	0,9 T
Magnetischer Fluss Magnetic flux	283 µWb
Obere Polplattenhöhe Height of front pole-plate	4 mm
Schwingspulendurchmesser Voice coil diameter	25 mm
Wickelhöhe Height of winding	8,5 mm
Schallwandöffnung Cutout diameter	109 mm
Gewicht netto Net weight	0,63 kg
Gleichstromwiderstand Rdc D.C. resistance Rdc	6 Ohm
Mechanischer Q-Faktor Qms Mechanical Q factor Qms	2,26
Elektrischer Q-Faktor Qes Electrical Q factor Qes	0,59
Gesamt-Q-Faktor Qts Total Q factor Qts	0,47

15.03.2013

Äquivalentes Luftnachgiebigkeitsvolumen Vas Equivalent volume Vas	12 l
Effektive Membranfläche Sd Effective piston area Sd	74 cm <sup>2</sup>
Dynamische bewegte Masse Mms Dynamically moved mass Mms	6 g
Antriebsfaktor Bxl Force factor Bxl	4,6 Tm
Schwingspuleninduktivität L Inductance of the voice coil L	0,6 mH