

KEMET Part Number: ESD-R-38SR-P
(UECESDR38SRP00)

KEMET, ESD-R-SR, EMI Cores, Noise Suppression

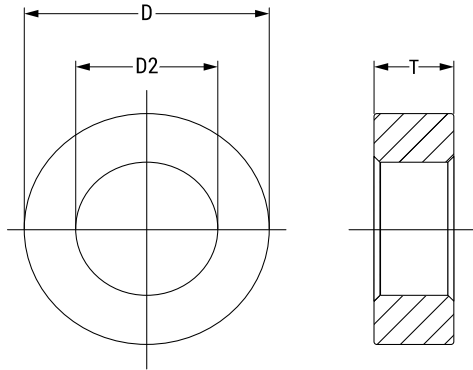

Dimensions	
D	39.5mm MAX
D2	18mm MIN
T	14mm MAX

Packaging Specifications	
Packaging:	Tray, Box
Packaging Quantity:	200
Weight:	53.3 g

General Information	
Series:	ESD-R-SR
Style:	Round - Toroidal
Cable Type:	Round Cable
Description:	EMI Core Solid, Large-Size Ring Type, For Round Cables, Coated Type
Features:	High Impedance, Effectively Suppresses Radiation at 150 kHz, Low Frequency Noise
RoHS:	Yes
Qualifications:	UL94 V-2
Case Color:	Gray
Materials:	Mn-Zn

Specifications	
Temperature Range:	-25/+85°C
Effective Frequency:	10 MHz (AM Band Range)