

SMART-IN16 B/U4



ECONOMICAL RECESSED PROFILE FOR 16 mm LED STRIP

EKONOMICZNY PROFIL WPUSTOWY DO TAŚM 16 mm

- SLICK socket - easy assembly technology
- various ways of mounting
- continuous line of light (when using LED strip 120 P/m and opal cover)
- maximum width of LED strip: 16 mm
- gniazdo SLICK - prosty montaż klosza
- rozmaite sposoby montażowe
- ciągła linia światła (przy zastosowaniu taśmy 120 P/m i klosza mlecznego)
- maksymalna szerokość taśmy LED: 16 mm



SIMILAR IN THE OFFER / PODOBNE W OFERCIE



SMART16
B/U4



SMART-IN10
A/Z



BEGTIN12
J/S



GROOVE14
EF/TY



LINEA-IN20
EF/U7



- B** slide cover
klosz B wsuwany
- U4**¹ U4 mounting plate
uchwyt U4
- U4**² cone U4 mounting plate
uchwyt U4 cone
- U4**³ spring U4 mounting plate
uchwyt U4 sprężyna

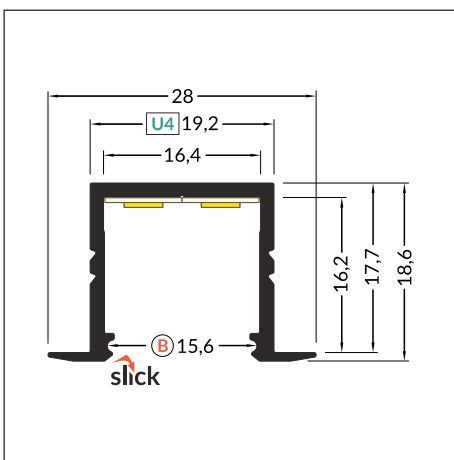
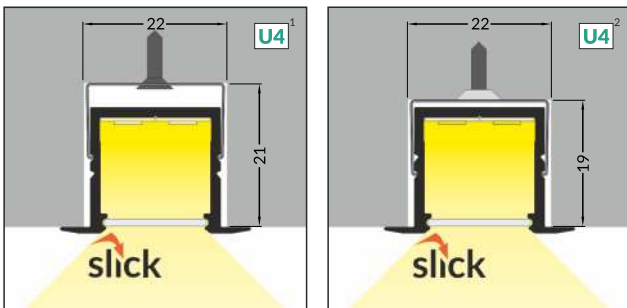
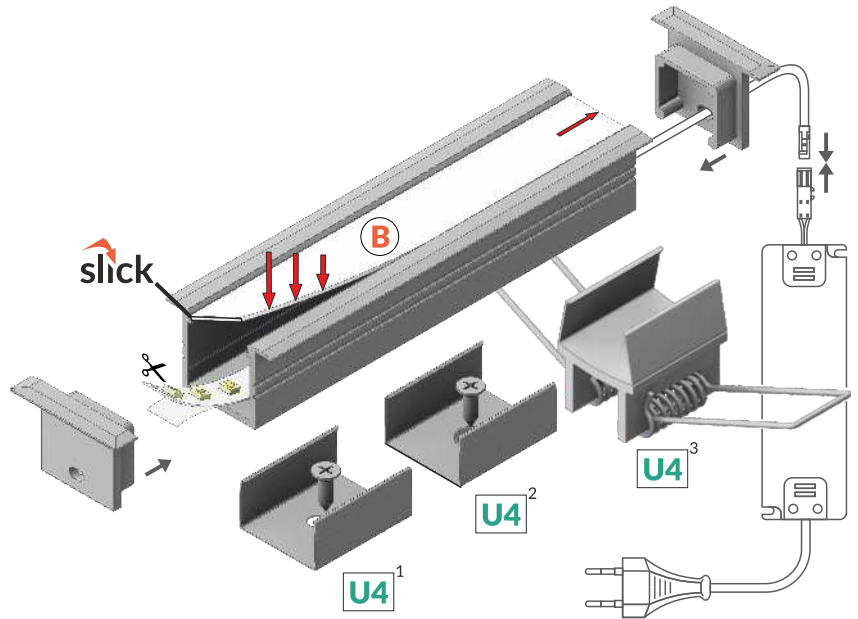

INDEX = 1 pc, length 2000 mm
package = 10 pcs
INDEKS = 1 szt., długość 2000 mm
opakowanie = 10 szt.

 white painted
biały malowany
F6000201

 anodized
anodowany
F6000220

 raw aluminium
surowe aluminium
F6000200

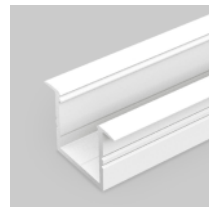

Available lengths: 1000 mm, 2000 mm, 3000 mm, 4000 mm.
The standard profile length tolerance is +2 mm.
For more details please see page 1.08.

Dostępne długości: 1000 mm, 2000 mm, 3000 mm, 4000 mm.
Standardowa tolerancja długości profili wynosi: +2 mm.
Więcej informacji na stronie 1.08.



COVERS / KLOSZE

B slide cover
colours: transparent, frosted, opal
material: PC, PP, PP

klosz B wsuwany
kolory: transparentny, szron, mleczny
materiał: PC, PP, PP

Note! Dimensions of the space to install LED source
Uwaga! Wymiary przestrzeni do zamontowania źródła LED

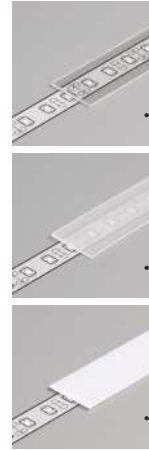
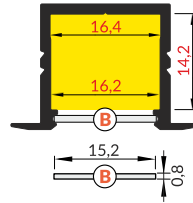

INDEX = 1 pc, length 2000 mm
package = 10 pcs
INDEKS = 1 szt., długość 2000 mm
opakowanie = 10 szt.

B transparent / B transparentny
76250016

B frosted / B szron
76250039

B opal / B mleczny
76250038

The standard cover length tolerance is +20 mm.
For more details please see page 1.08.

Standardowa tolerancja długości kloszy wynosi: +20 mm
Więcej informacji na stronie 1.08.

ENDINGS / ZAŚLEPKI

SMART-IN16 ending with hole
colours: white, silver, black, grey
material: ABS

zaślepka SMART-IN16 z otworem
kolory: biały, srebrny, czarny, szary
materiał: ABS

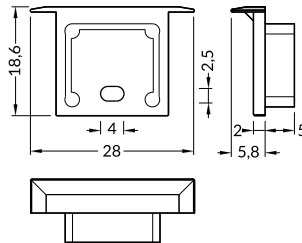

INDEX = 1 set
package = 10 sets = 20 pcs
INDEKS = 1 kpl
opakowanie = 10 kpl = 20 szt.

white / biały
F6009901

silver / srebrny
F6009940

grey / szary
F6009922

MOUNTINGS / MOCOWANIA

U4 mounting plate
colours: white, inox
material: stainless steel

uchwyt U4
kolory: biały, inox
materiał: stal nierdzewna

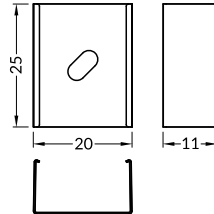
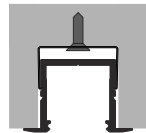

INDEX = 1 set
package = 10 sets = 20 pcs
INDEKS = 1 kpl
opakowanie = 10 kpl = 20 szt.

U4 mounting plate
uchwyt U4

white biały F1970001

inox inox F1970019

cone U4 mounting plate
colours: white, inox
material: stainless steel

uchwyt U4 cone
kolory: biały, inox
materiał: stal nierdzewna

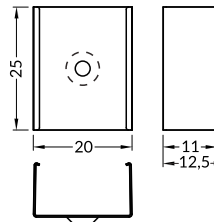
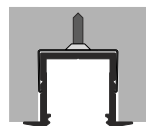

cone U4 mounting plate
uchwyt U4 cone

white biały F1980001

inox inox F1980019

spring U4 mounting plate
colours: inox
material: stainless steel

uchwyt U4 sprężyna
kolory: inox
materiał: stal nierdzewna

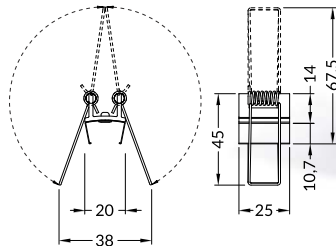

INDEX = 2 pcs
INDEKS = 2 szt.

spring U4 mounting plate
uchwyt U4 sprężyna

inox inox F6009819S

