



# UNI-T®



## UT805A Operating Manual

**Bench Type  
Digital Multimeter**

P/N:110401103783

## Table of Contents

Item	Page
I. General information-----	3
II. Unpacking inspection-----	3
III. Safe work rules-----	4
IV. International electric symbol-----	5
V. Comprehensive index-----	6
VI. Exterior structure diagram and user interface-----	7
VII. Button function-----	10
VIII. Measurement description-----	12
1. DC voltage measurement-----	12
2. AC voltage measurement-----	13
3. DC/AC current measurement-----	14
4. Resistance measurement-----	15
5. Diode measurement-----	17
6. Open/closed circuit measurement-----	18
7. Capacitance measurement-----	19
8. Frequency ratio measurement-----	20

<b>Item</b>	<b>Page</b>
IX. Technical index-----	21
X. Correctness calibration (CAL)-----	28
XI. RS232C standard serial interface-----	32
A. RS232C interface connection and mounting-----	32
B. RS232C interface setting-----	32
XII. USB port-----	33
XIII. Communication protocol-----	34
1. Format of data uploaded-----	34
2. PC order format-----	38
XIV. Installation and use of interface software-----	39
XV. Upkeep and maintenance-----	40
1. General upkeep and maintenance-----	40
2. Change fuse-----	40

## I. General information

UT805A is a 5 1/2 table type digital multimeter (hereafter referred to as “The instrument” ), designed by combining the large-size integrated simulation circuit with the digital circuit. The instrument adopts the microprocessor technology, uses the 24-digit A/D converter as the core, high accuracy computing amplifier, true-RMS AC/DC convertor and electronic adjustment technique, offering the instrument high reliability and high accuracy. The instrument can be used for measuring the AC/DC voltage, AC/DC current, resistance, diode, circuit continuity, capacitance and frequency, with the storage and read-back function. The RS232C and application of USB interface technology makes the instrument form reliable and multiple two-way communication with computer.

The instrument uses particular appearance design and Adopts 256X64 pixels matrix LCD display, allowing to display Multiple information simultaneously. The instrument uses the AC commercial power, making it become the high accuracy electrical instrument with the best performance.

This Operating Manual includes the related safety information, warning and instructions. Please read the relevant contents and abide by all warning and precautions.

### Warning:

Before using the instrument, please read “Safety Information and Requirements” . The instrument is a Grade-A product, suiting for making precision measurement by measuring room and laboratory.

## II. Unpacking inspection

When opening the package and removing the instrument, please check if the any one of the following fittings is missing or damaged. If yes, please contact your supplier immediately.

- Operating Manual-----1 copy
- \* Pen-shape meter -----1 piece
- \* Test line -----1 pair
- Power cable -----1 piece
- \* Crocodile clip with bushing -----1 pair
- \* RS232 interface line -----1 piece
- \* Electrical outlet-----1 piece
- Interface software disc -----1 piece

The accessories marked with"\*"are placed in the back of the apparatus. please refer to figure 17 on page 40 for removal procedure.



## III Safety Guidelines

This meter is designed and produced by strictly complying with the GB4793 of safety requirement for electronic measuring instruments and safety standards IEC1010-1. It is consistent with the safety standards of double insulation, over-voltage standard CAT I 1000V, CAT II 600V and pollution degree " ". If the meter is not used in accordance with the operation instructions, it may be weakened or lost the ability to provide protection.

1. Inspect the side meter, meter pen and power line before use to guard against any damage or abnormal phenomenon, please do not use if some of the following abnormal items are detected: such as uncovered power lines and meter pen, broken case, failure display of dot matrix LCD, etc. Do not use the meter with cover open, otherwise there will be a risk of electric shock.

2. The broken power lines and meter pen must be replaced, and must be with the same model or the same electrical specification.

3. During the operation of meter, do not touch exposed wires, connectors, input terminal without in use or circuit which is measured.

4. Be careful when measure the voltage which is higher than DC 60V or AC 30V, and must always remember that your fingers do not exceed the protective finger position of the meter pen to prevent electric shock.

5. When using the manual range measurement, and if the measured size range can not be determined, then the meter functional key should be placed on the largest range position. Do not exceed the input limit value required for each range.

6. When measuring, the meter functional key must be placed on the correct range stalls, before the functional range conversion, the connection between meter pen and tested circuit must be disconnected, do not convert stalls during the process of the measurements to prevent from damaging the equipment.







7. Before carrying out the online resistance, diode or circuit on-off measurement, firstly make sure that all power in the circuit must be cut off and all the residual charges in the capacitor must be exhausted.

8. Do not store or use meter in heat, humidity, flammable, explosive and strong electromagnetic environment.

9. Please do not randomly change the internal wiring of meters, in order to avoid damaging the meter and having negative influence on security

10. Do not disconnect the power line during the measurement.

## IV. International Electric Symbol

	AC or DC
	Grounding
	Safety sign (for warning)
	Double insulation
	High pressure warning
	Meets the direction of European Union

## V. Comprehensive index

1. Measure the maximal voltage between input terminal and ground: See the description for input protection voltage for each measuring range;
2. Display mode: 256X64 pixels matrix LCD display
3. Measuring principle:  $\Sigma$ - $\Delta$  A/D conversion
4. Selection of measuring range: Manual / Automatic
5. Measuring speed: 2 times/second roughly; 100 times/second when measuring at the maximal or minimal value;
6. Unit display: To display the symbol of function or electric quantity unit
7. Polarity display: Automatic
8. Over-range hint: by displaying “OL”
9. Power supply: AC110V 50Hz
10. Working temperature: 0~40°C (32°F~104°F)
11. Storage temperature: -10~50°C (14°F~122°F)
12. Electromagnetic compatibility: Under the radio-frequency field of 1V/m, i.e.: Total accuracy = Designated accuracy + 5% measuring range. Under the radio-frequency field when surpassing 1V/m, there is the designated index; so it should avoid to work under the intense electric electromagnetic field; otherwise the instrument may occur some abnormal phenomena.
13. Power source: AC 110V  $\pm$  10% / 50Hz (sine wave)
14. External dimension: 240 X 105 X 370mm
15. Mass: Net weight: 2.9kg (Weight of fittings: 0.4kg)
16. Safety standard: IEC 61010; CATI 1000V, CATII 600V
17. Appraisal:  $\text{C}\text{C}$  Yue-word No. 19000019 Manufactured by Chain Bureau of Technical Supervision License of measuring apparatus.

## VI. Exterior Structure Diagram and User Interface

1. Front view (See Figure 1)

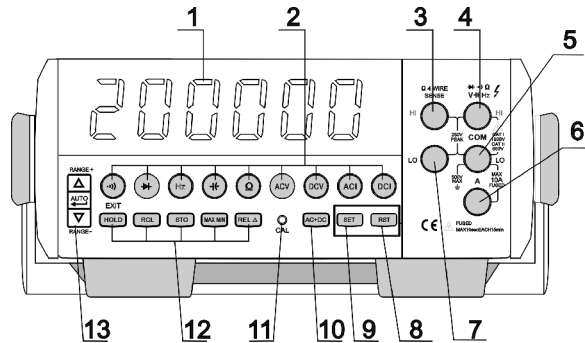

Figure 1

- 1) Dot matrix LCD display;
- 2) Main functional button: select the wanted function;
- 3) HI input terminal: when measuring the electric resistance by 4-wire system: insert the red pen-shape meter into the high-end of electricity;
- 4)  $V \Omega \leftarrow Hz \rightarrow \rightarrow \rightarrow$  Input terminal: this is the positive electrode input terminal when measuring the voltage, resistance, capacitance, frequency, diode and circuit continuity, i.e.: Insert the red pen-shape meter (HI input terminal: high-end

- Of voltage when measuring the resistance by 4-wire system).
- 5) COM input terminal: this is the negative electrode input terminal, i.e.: insert the black pen-shape meter here (LO input port: insert the black pen-shape meter at the low-end of voltage when measuring the resistance by 4-wire system).
- 6) Electricity input port: this is the positive electrode input terminal when measuring the alternating current or direct current, insert the red pen-shape meter here;
- 7) LO input terminal: this is the low-end of electricity when measuring the resistance by 4-wire system, insert the black pen-shape meter here;
- 8) Reset button: to reset the system;
- 9) Setting button: to set the system;
- 10) AC+DC button: Measurement of alternating voltage and current with DC bias
- 11) CAL adjusting button: to adjust the correctness of voltage, current and resistance;
- 12) Auxiliary function button: select various functions;
- 13) Measuring range button: to select the automatic / manual measuring range, up / down / confirm button for system settings.

## 2.Back View (See Figure 2)

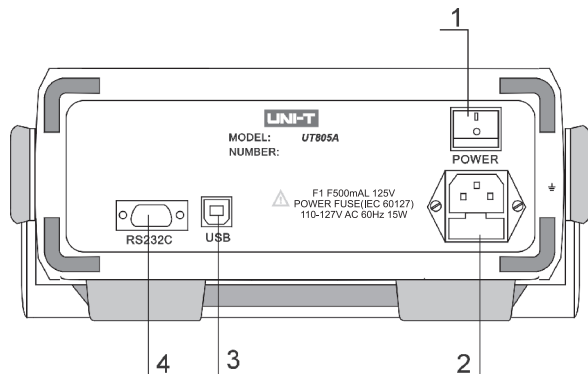

Figure 2

- 1) Switch: AC110V/50Hz power switch
- 2) Plug: AC110V/50Hz power input plug;
- 3) USB port;
- 4) RS232C interface

## 3.View of Display Interface (See Figure 3)

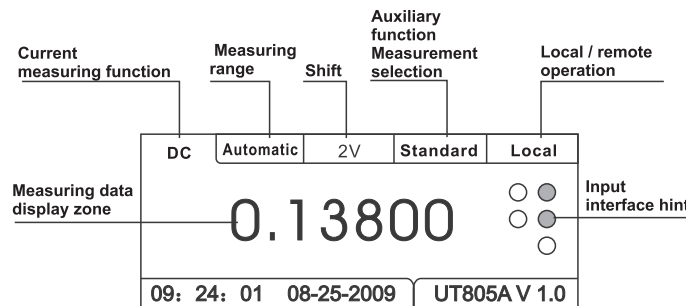

Figure 3

## 4. View of Main Interface for Instrument Setting (See Figure 4)

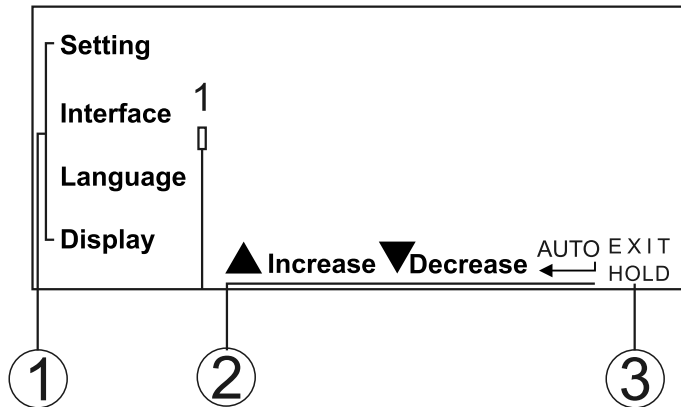

Figure 4

- 1) Setting options;
- 2) Adjust the setting options by using  $\triangle$  button,  $\nabla$  button and AUTO button;
- 3) Press HOLD (EXIT) button to exit.

## VII. Button Function

1. (AUTO ▾ button) Auto/manual measuring range shift: The default is the DC voltage, AUTO mode and 2V. Press △ button or ▾ button, the system will go into the last measuring range; i.e.: press “△ button”. It can increase; press “▾ button”, it can decrease. Under the manual measuring range mode, it will open the automatic measuring range status when shifting the measuring functions (except the manual measuring range). If there are multiple measuring ranges, the button of △ and ▾ will be workable; when AC or DC voltage equals to 200mV, it is the manual measuring range.
2. ( ) button) Measurement on circuit continuity;
3. (▶ button) Measurement on voltage drop of diode;
4. (Hz button) Frequency measurement;
5. ( button) Capacitance measurement;
6. (Ω button) Resistance measurement: by pressing this button, the instrument will begin resistance measurement; the two-end and four-end measurement will be entered from the front panel;
7. (ACV button) Measurement on AC voltage (True-RMS);
8. (DCV button) Measurement on DC voltage;
9. (ACI button) Measurement on AC current (True-RMS);
10. (DCI button) Measurement on DC current;
11. (AC+DC button) Measurement on AC voltage and current with DC offset (True-RMS): by pressing this button, it can measure the AC voltage or current with the DC offset; this button will only be workable under the “ACV” and “ACI” measuring mode; under the other measuring mode, the button is not workable.
12. (CAL button) Accuracy Calibration Button: the AC/DC voltage, current, and the AC voltage with the DC offset, current and resistance can be corrected as per the rules of “. Correctness Calibration”;
13. (REL △ Button) Relative Value Display: By pressing REL △ Button, the instrument will use the current displayed value as the reference value, and set the display to “0”. Meanwhile the reference value will be displayed at the position of Date Bar on the LCD. The reference value will be deducted automatically from the subsequent measuring results; the relative value will not be displayed until the REL △ button is pressed. Except the measurement on circuit continuity, diode and frequency, the relative value measurement function is available. By using this Function, it can make the system shift the measuring range from the manual one to automatic one. By pressing AUTO button whilst displaying the relative value, it can exit the relative value display mode and access to the Automatic measuring range;
14. (MAX, MIN Button) Statistics Display: By pressing this button, it can access to the Statistical mode, with the current value to be displayed at the right bottom corner of LCD. By pressing this button firstly, it will display the maximal value; by pressing this button again, it will display the minimal value; by pressing this button thirdly, it will

Display the average value; by pressing this button fourthly, it will display all statistical values. This display will cycle with each frequency of press. After accessing to the Statistical Value status, it is prohibited to press the “REL Button” again. It can access to the Statistical Mode for all measuring functions to make statistics on measuring data. After accessing to this mode, the clock display update will stop, but start recording the statistical time, and display the duration time of statistics when displaying all statistical values;

15. (STO and RCL button) Storage and Read-back: The STO button is the storage button and the RCL button is the read-back button. When pressing STO button, the measurement reading will be stored, and the data saved previously will be cleared. When accessing to the storage setting mode, it needs to press STO button after opening the storage mode (with the interval less than 1s); the interval for pressing STO button must be less than 1s, otherwise it will exit the Storage Setting mode; there are 17 storage rates, i.e.: By pressing STO Button, the displayer will display: interval = 1 second, meaning a reading will be stored every 1 second; interval = 60 seconds, meaning a reading will be stored every 60 seconds; interval = 1 minute, meaning a reading will be stored every 1 minute; interval = 60 minutes, meaning a reading will be stored every 60 minutes; interval = manual, meaning a reading will be stored manually; at this time, it needs to press STO button manually, and each reading will be stored with every press.

Under the STO status, the RCL button will flash when 100 readings are stored, meaning the storage is full. At this time it must press EXIT (HOLD) button to exit the current status; press the RCL button, it will read back the maximal value; and it will read back the minimal value by another press, and then the average value, the first reading, the second reading, till the 100<sup>th</sup> reading. Under the STO status, if it does not want to store 100 readings, it can also press EXIT (HOLD) button to exit. Press RCL button to read back, and the reading stored must only be read back under the original measuring function. Otherwise it will be unworkable. If exiting “Read-back”, please press EXIT (HOLD) button;

16. (HOLD/EXIT Button): The first button is the function to keep display; by pressing this button, it can keep the reading of instrument unchanged; by pressing the button again, it will exit the function; the second button is the function to exit the current function under the storage, read-back, MAX/MIN and system setting status;
17. (SETUP BUTTON) To set the system parameters: By pressing this button, it can access to the setup menu. By pressing this button again, it can exit the Setup status. Under the Setup mode, the buttons of  $\triangle$  and  $\nabla$  are used to select menu and adjust the parameters; the AUTO button is the “Ok” button; this button can be used to confirm the parameters; when setting the clock, by pressing AUTO, it will select the setup digit of clock; by pressing AUTO twice, it means the clock setup is finished.



- The HOLD/EXIT button is the button to exit; by pressing this button, it can return to the last menu; when it is the first menu, it will exit the Setup mode if pressing this button;
- (RST button) System reset: by pressing this button, it will reset the system and restart initializing. Note: If the button function is unworkable or unworkable, the buzzer will alarm, with the alarming interval to be 0.5 seconds roughly.

### VIII. Measurement description

The button and input port shown by deep color in the following diagram is the button and input port it can be used for the given function.

#### 1. DC voltage measurement (See Figure 5)

- Insert the red pen-shape meter into “V  $\Omega$  Hz  $\rightarrow$   $\rightarrow$ ”)” input port and the black pen-shape meter into “COM” input port;
- Press “DCV” button (The default is the AUTO measuring range), and then select the manual or automatic measuring range as per the given demand. “ $\Delta$ ” is the ascending measuring range, “AUTO” is the automatic measuring range and “ $\nabla$ ” is the descending measuring range. Under the manual measuring range, it will make the pen-shape meter get short-circuit if there is reading at the zero position. By using REL button, it can clear the reading and make zero calibration, and then improve the measuring accuracy; afterwards, connect the pen-shape meter with the signal

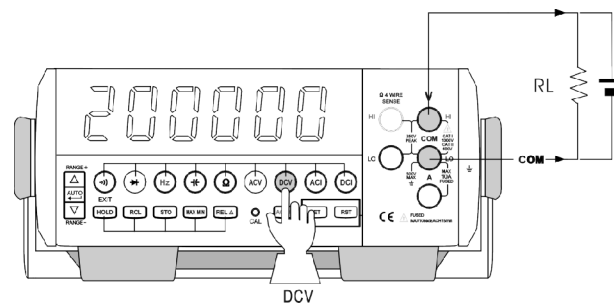

Figure 5

under measurement in series, the main displayer will display the measurement result directly, with the measuring range to be displayed on the upper right side of sub-displayer. The collecting speed for DC measurement is 2 frequencies per second approximately.

#### ⚠ Note:

- Never input the voltage over 1000Vdc or 750 Vac. It is possible to display a higher voltage, but may damage the instrument;
- When measuring the high voltage, it must take measures to prevent electric shock;
- After finishing measurement, please disconnect the pen-shape meter and the circuit under the measurement, and then take the pen-shape meter away from the input terminal of instrument.

## 2. AC voltage measurement (See Figure 6)

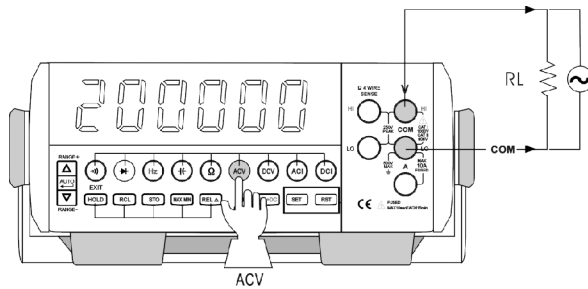

Figure 6

- 1) Insert the red pen-shape meter into “V Ω Hz” input port and the black pen-shape meter into “COM” input port;
- 2) Press “ACV” button, it will access to the “Awaiting for measurement” status in 8 seconds. Select the measuring range as per the demand, and then connect the pen-shape meter with the signal under measurement in parallel; set the collecting speed of AC measurement to be 1 frequency per second;

3) The main display will display the true-RMS of AC measurement; the effective measurement reading is suitable for 10%~100% of measuring range, with the frequency value of the signal under measurement to be displayed at the upper right side of sub-displayer;

4) When measuring the AC signal with the DC offset, it must press “AC+DC” button after pressing the “ACV” button; otherwise it will be unworkable.

### ⚠ Note:

- Never input the voltage over 1000Vdc or 750 Vac. It is possible to display a higher voltage, but may damage the instrument;
- When measuring the high voltage, it must take measures to prevent electric shock;
- After finishing measurement, please disconnect the pen-shape meter and the circuit under the measurement, and then take the pen-shape meter away from the input terminal of instrument;
- When the input terminal is short-circuited, the zero position less than 500 characters is allowable, which will not influence the measuring accuracy. Under the automatic measuring range, the true-RMS converter has a long time for stabilization, so it needs to make measurement on frequency of AC signal. Under the circumstance that a reading changes from a lower value to a higher value, it will need a long time when correcting the time for making reading steady at the automatic measuring range level.

### 3. DC/AC Current Measurement (See Figure 7 & 8)

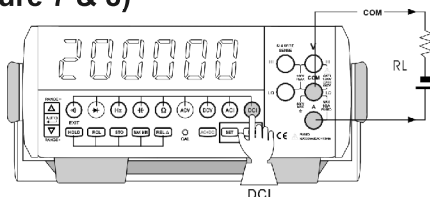

Figure 7

1) Press DCI or ACI button (the default is AUTO measuring range); select manual or automatic measuring range as per the demand. “△” button is the ascending measuring range; “AUTO” is the automatic measuring range and “▽” is the descending measuring range. Insert the red pen-shape meter into “10A MAX” input port and the black pen-shape meter into “COM” input port;

2) Set the measuring range switch as per the demand, and connect the pen-shape meter of instrument with the circuit under measurement in series. If so, the main displayer will show the measurement value directly; the efficient measuring reading of ACI is only suitable for 10%~100% of measuring range;

3) When measuring the AC current with the DC offset, it must press “AC+DC” button after pressing the “ACI” button; otherwise it will be unworkable.

#### **⚠ Note:**

- Please use the correct input terminal, function shift and

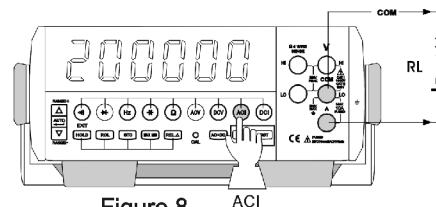

Figure 8

measuring range button correctly;

- When measuring at the 10A of measuring range, and when the current under measurement is larger than 5A, the measuring duration for each time must be less than 10 seconds, and the interval must be more than 15 minutes;
- When the measuring value is larger than the given range, the buzzer will alarm;
- When inserting the pen-shape meter into the input port of current, please do not connect the pen-shape meter with any circuit in parallel; otherwise it may burn the fuse and damage the instrument;
- Upon completion of all measurements, it is necessary to cut the connection between pen-shaped meter and measured circuit and take off the pen-shape meter from input port of meter.
- When using the AC current to measure the input pull-down, the reading less than 500 characters is allowable, which will not influence the measuring accuracy, this is just because that the true-RMS AC current measurement needs a long time for stabilization; besides, it needs to make

## Operating Instruction of UT805A

measurement on frequency of AC current. Under the circumstance that the reading under measurement changes from a lower value to a higher value, it will need a long time for becoming steady.

### 4. Resistance measurement (See Figure 9 and Figure 10)

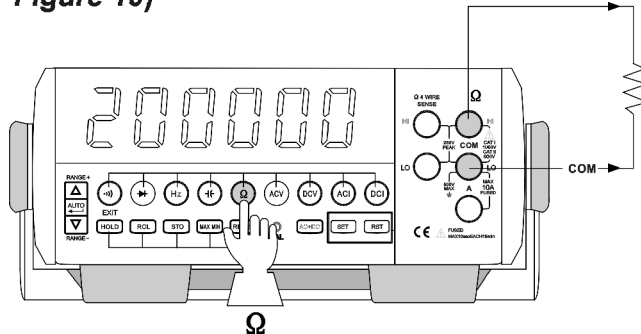

Figure 9

1) The Figure 9 shows the Two-end resistance measuring method, with the resistance to be entered from the front panel. At this time, insert the red pen-shape meter into “V Ω Hz →” input port and the black pen-shape meter into “COM” input port;

2) Press “Ω” button, the instrument will start the resistance measurement function. Select the wanted measuring

range (Manual / Automatic). Under the manual measuring range mode, it will make the pen-shape meter get short-circuit if there is reading at the zero position. By using REL button, it can clear the reading and make zero calibration, and improve

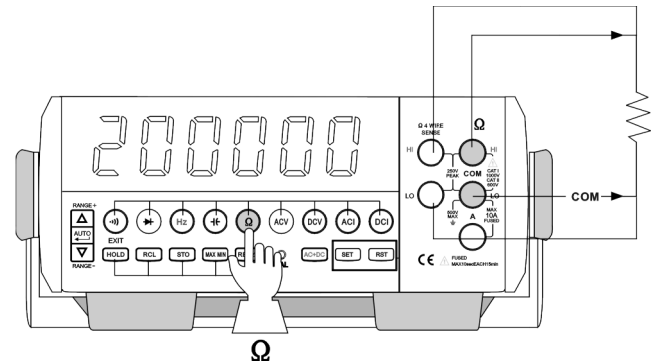

Figure 10

the measuring accuracy; afterwards, connect the pen-shape meter with the resistance under measurement in parallel;

3) The main display will show the measuring result directly, with the sub-displayer showing the measuring range;

4) The Figure 10 shows the four-end resistance measuring method. At this time, it should use two pairs of pen-shape

meters. Insert the red pen-shape meters of the two pairs of pen-shape meters into two red input ports and the two black pen-shape meters into two black input ports, with the other four ends of four pen-shape meters to be connected under a short-circuit; use the REL button to clear the zero position. Afterwards, connect two red pen-shape meters with one end of resistance under the measurement in parallel, and the two black pen-shape meters with the other end of resistance under the measurement;

5) The main displayer will show the measuring result directly, with the sub-displayer showing the measuring range. The four-end resistance measuring method can relieve the influence of resistance of leading wire, therefore it is mostly suitable for measuring the less resistance.

### ⚠ Note:

- If the open circuit of resistance or resistance value exceeds the maximal measuring range of instrument, it will display only “OL” on the LCD;
- When inspecting the line resistance, it must switch the power off and discharge the capacitor before measuring; if so it can only ensure the measurement accuracy;
- When measuring the resistance over  $1M\Omega$ , the reading will become stable in several seconds. This is a normal phenomenon for the measurement on high resistance. In order to get a stable reading, please use the test wire as short as possible;

- Never input the voltage higher than DC 60V or AC 30V, otherwise it may cause personnel injury;
- After finishing measurement, please disconnect the pen-shape meter and the circuit under the measurement.

## 5. Diode Measurement (See Figure 11)

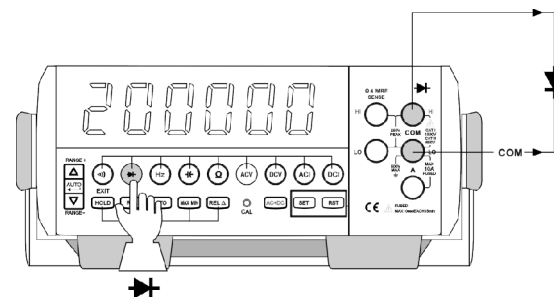

Figure 11

- 1) Insert the red pen-shape meter into “V Ω Hz” input port and the black pen-shape meter into “COM” input port; the polarity of the red pen-shape meter is “+” and the black pen-shape meter is “-”;
- 2) Press “▶” Button, and connect the red pen-shape meter with the positive electrode of diode under the measurement and the black pen-shape meter with the negative electrode;

## Operating Instruction of UT805A

3) It will display the approximate forward PN-node junction voltage of the diode under the measurement on the LCD directly. For the silicon PN-node, the value between 500~800mV is normal. The measuring range of 6V is displayed on the sub-displayer at the upper right side.

### **Note:**

- If the open circuit or polarity of the diode under the measurement is connected reversely, it will display “OL” on the LCD;
- When measuring the diode, it must switch the power off and discharge the capacitor before measuring;;
- The voltage for open circuit of diode under the measurement is 2.8V roughly;
- Never input the voltage higher than DC 60V or AC 30V, otherwise it may cause personnel injury;
- After finishing measurement, please disconnect the pen-shape meter and the circuit under the measurement, and then take the pen-shape meter away from the input terminal of instrument.

## 6. Open/closed circuit measurement (See Figure 12)

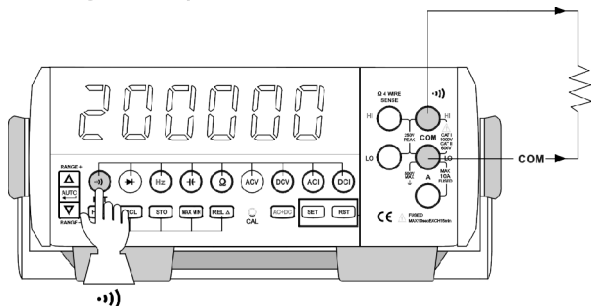

Figure 12

1) Insert the red pen-shape meter into “V Ω Hz” input port and the black pen-shape meter into “COM” input port; press “••)” button to start the test; connect the pen-shape meter with the two ends of the circuit under measurement;

2) If the resistance between two ends of the circuit under the measurement is less than  $30\ \Omega$ , the built-in buzzer will send a sound, meaning the circuit under the measurement is open, with the main displayer to show the reading of resistance and the sub-displayer to show the measuring range of  $600.0\ \Omega$ . The voltage for the open circuit between the two measuring ranges is 1.2V roughly;

### ⚠ Note:

- If the circuit under the measurement is open, it will display “OL” on the LCD;
- The test voltage for the open circuit under the measurement is 1.2V roughly;
- When measuring the continuity of circuit, it must switch the power off and discharge the capacitor before measuring;
- Never input the voltage higher than DC 60V or AC 30V, otherwise it may cause personnel injury;
- After finishing measurement, please disconnect the pen-shape meter and the circuit under the measurement, and then take the pen-shape meter away from the input terminal of instrument.

## 7. Capacitor Measurement (See Figure 13)

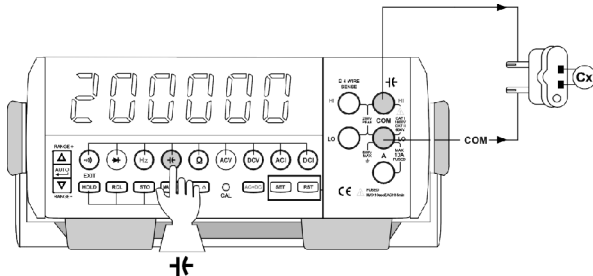

Figure 13

1) Insert the red pen-shape meter into “ V Ω Hz ” input port and the black pen-shape meter into “ COM ” input port;

2) Press “  $\leftarrow$  ” button to start measurement. At the input open-circuit and under the manual measuring range mode, it can use REL button to clear the zero position; select the automatic or manual measuring range, the “  $\nabla$  ” button of manual measuring range will be unworkable. Connect the pen-shape meter with the capacitor under measurement in parallel. For the capacitor with the diameter of the leading wire less than 0.6mm, it is recommended to use the power plug to make capacitor measurement (See the Figure for details), it can lessen the influence on capacitance, therefore it is mostly suitable for measuring the low capacitor;

3) The measuring result will be displayed directly on the LCD, with the measuring range to be displayed on the sub-displayer.

### ⚠ Note:

- If the capacitor under the measurement is of short-circuit or the capacitance exceeds the maximal measuring range of instrument, it will display only “ OL ” on the LCD;
- Discharge the capacitor before measuring;
- If the capacitor under the measurement has polarity, it should connect the red test wire with the positive electrode of capacitor and the black test wire with the negative electrode;
- When measuring the capacitor over 10  $\mu$  F, the reading will become stable in several seconds. This is a normal phenomenon;
- Never input the voltage higher than DC 60V or AC 30V, otherwise it may cause personnel injury;
- After finishing measurement, please disconnect the pen-shape meter and the circuit under the measurement.



## 8. Frequency Measurement (See Figure 14)

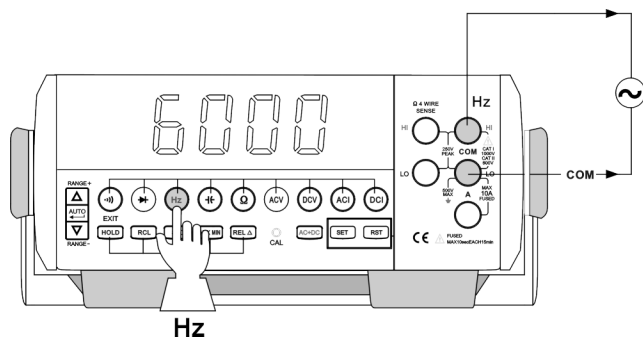

Figure 14

- 1) Insert the red pen-shape meter into “V Ω (- Hz → →)” input port and the black pen-shape meter into “COM” input port;
- 2) Press “Hz” button to start the frequency measurement; select the automatic or manual measuring range; when the manual measuring range is selected, the “▽” button will be unworkable. Connect the pen-shape meter with the signal source under measurement in parallel;
- 3) The measuring result will be displayed directly on

the LCD, with the cycle of the frequency under the measurement to be displayed on the sub-displayer.



### Note:

When measuring, it must meet the requirements of input breadth a. Input breadth: a (DC level is zero)

10Hz~1MHz:  $150\text{mV} \leq a \leq 30\text{Vrms}$

> 1MHz~10MHz:  $300\text{mV} \leq a \leq 30\text{Vrms}$

> 10MHz~50MHz:  $600\text{mV} \leq a \leq 30\text{Vrms}$

> 50MHz: undetermined.

Never input the voltage higher than DC 60V or AC 30V, otherwise it may cause personnel injury;

After finishing measurement, please disconnect the pen-shape meter and the circuit under the measurement, and then take the pen-shape meter away from the input terminal of instrument. .

## IX. Technical index

- Tolerance limit:  $\pm$  (a% reading + characters), Warranty period; 1 year
- Environmental temperature: 18~28°C
- Environmental humidity: less than 75% RH
- Temperature coefficient: 0.1x precision / 1°C
- Pre-heat time before start: 1 hour roughly.

### 1.DC Voltage measurement

Measuring range	Measuring range	Resolution	Tolerance limit
200mV	1 $\mu$ V~220.000mV	1 $\mu$ V	$\pm$ (0.015%+4) In the test lead short-circuit REL status
2V	10 $\mu$ V~2.20000V	10 $\mu$ V	$\pm$ (0.015%+3)
20V	100 $\mu$ V~22.0000V	100 $\mu$ V	$\pm$ (0.015%+4)
200V	1mV~220.000V	1mV	$\pm$ (0.015%+3)
1000V	10mV~1000V	10mV	

Input resistance: 200mV, 2V: over 500M $\Omega$   
 20V, 200V, 1000V, equals to 10 M $\Omega$  roughly

Overload protection: 1000V DC or 750V AC

## 2.AC Voltage measurement (true-RMS)

Measuring range	Resolution	Tolerance limit: $\pm$ (a% reading + character)			
		40Hz ~ 5 kHz	> 5 ~ 30kHz	> 30 ~ 50kHz	> 50 ~ 100kHz
200mV	1 $\mu$ V	$\pm$ (0.2%+100)	$\pm$ (0.2%+100)	$\pm$ (0.5%+200)	$\pm$ (0.8%+200)
2V	10 $\mu$ V				
20V	100 $\mu$ V	$\pm$ (0.2%+100)	$\pm$ (0.8%+300)	$\pm$ (2.5%+500)	$\pm$ (5%+500)
200V	1mV			*	*
750V	10mV	40Hz ~ 1 kHz	> 1 ~ 2kHz	*	*
		$\pm$ (0.3%+100)	$\pm$ (0.4%+100)		

Input resistance: 10 M $\Omega$

Overload protection: 1000V DC or 750V AC

### Note:

- Except the measuring range of AC750V, the display code for each full measuring range is 220000; the valid display reading is suitable for 10%~100% of measuring range only;
- When the frequency of input signal is larger than 50KHz, the instrument needs a longer time for obtaining a stable reading;
- AC+DC tolerance limit: Same to AC+1%

### 3. DC Current Measurement

Measuring range	Measuring scope	Resolution	Tolerance limit
2mA	0.01 $\mu$ A~2.20000 mA	0.01 $\mu$ A	$\pm$ (0.05%+10)
200mA	1 $\mu$ A~220.000 mA	1 $\mu$ A	
10A	0.1 mA~10.0000 A	0.1mA	$\pm$ (0.8%+60 )

Overload protection: Full-measuring range: Fuse 10A H 250V Quick-fuse  $\Phi$  5x20mm (A);  
 $\leq$  5A, allowable for continuous measurement;  
 $>$ 5A continuous measuring time  $\leq$  10 seconds, time interval: 15 minutes

### 4. AC current measurement (Frequency scope: 40Hz ~ 5KHz)

Measuring range	Measuring scope	Resolution	Tolerance limit
2mA	0.01 $\mu$ A~2.20000 mA	0.01 $\mu$ A	$\pm$ (0.3%+400)
200mA	1 $\mu$ A~220.000 mA	1 $\mu$ A	
10A	0.1 mA~10.0000 A	0.1mA	$\pm$ (2%+200)

Overload protection: Full-measuring range: Fuse 10A H 250V Quick-fuse  $\Phi$  5x20mm (A);  
 $\leq$  5A, allowable for continuous measurement;  
 $>$ 5A continuous measuring time  $\leq$  10 seconds, time interval: 15 minutes

#### Note:

- The valid display reading is suitable for 10%~100% of measuring range only;
- AC+DC tolerance limit: Same to AC+1%

## 5. Resistance measurement

Measuring range	Measuring scope	Resolution	Tolerance limit
200 Ω	0.001 Ω ~ 220.000 Ω	0.001 Ω	± (0.08%+50) *
2k Ω	0.01 Ω ~ 2.20000 k Ω	0.01 Ω	± (0.02%+6)
20k Ω	0.1 Ω ~ 22.0000 k Ω	0.1 Ω	
200k Ω	1 Ω ~ 220.000 k Ω	1 Ω	
2M Ω	10 Ω ~ 2.20000 M Ω	10 Ω	± (0.04%+8)
20M Ω	100 Ω ~ 22.0000M Ω	100 Ω	± (0.25%+6)

Overload protection: 1000V Dc or 750V AC  
 Open-circuit voltage: 2V approximately

\*: Under the short-circuited REL status

## 6. Capacitor Measurement

Measuring range	Measuring scope	Resolution	Tolerance limit
60nF	10pF~59.99nF	10pF	± (2.0%+5)
600nF	100pF~599.9nF	100pF	± (2.0%+5)
6 μ F	1nF~5.999 μ F	1nF	
60 μ F	10nF~59.99 μ F	10nF	± (3%+5)
600 μ F	100nF~599.9 μ F	100nF	± (5.0%+5)
6mF	1 μ F~5.999mF	1 μ F	Undetermined

Overload protection: 250Vp

\*: Under REL status

## 7. Frequency Measurement

Measuring range	Measuring scope	Resolution	Tolerance limit
6kHz	1Hz~5.999kHz	1Hz	± (0.1%+3)
60kHz	10Hz~59.99kHz	10Hz	
600kHz	100Hz~599.9kHz	100Hz	
6MHz	1kHz~5.999MHz	1kHz	
60MHz	10kHz~59.99MHz	10kHz	

### Overload protection: 250Vp

#### Input breadth a (DC level is zero)

10Hz~1MHz:  $150\text{mV} \leq a \leq 30\text{Vrms}$

>1MHz~10MHz:  $300\text{mV} \leq a \leq 30\text{Vrms}$

>10MHz~50MHz:  $600\text{mV} \leq a \leq 30\text{Vrms}$

> 50MHz: undetermined

## 8. Diode Measurement

Measuring range	Measuring scope	Resolution	Input protection	Remark
	0.00~6.00V	10mV	250Vp	The open-circuit voltage is 2.8V roughly; the normal junction voltage of silicon P/N node is 0.5~0.8V.

## 9. Open/Closed Circuit Measurement

Measuring range	Measuring scope	Resolution	Input protection	Remark
	0~600Ω	1Ω	250Vp	<ul style="list-style-type: none"> <li>• The open-circuit voltage is -1.2V roughly;</li> <li>• The circuit is open well; resistance <math>\leq 10\Omega</math>; the buzzer sends sound continuously;</li> <li>• The circuit is closed, resistance <math>\geq 30\Omega</math>; the buzzer does not send a sound.</li> </ul>



## X. Correctness Correction (CAL)

This function is only workable under the Manual Measuring Range mode. Keep the preheating time before startup larger than 30 minutes; the correctness of the standard source must be better than 1/3 of the correctness of the measuring range under the correctness. For the standard and measurement, please use the Manual Measuring Range.

### 1. DC Voltage (The positive and negative polarity must be corrected)

200mV: Input pan-shape meter short-circuit, press REL button to clear the Zero position; input  $\pm 190\text{mV}$ , press CAL button, the display will display : (--CAL--)  $\rightarrow$  (-HI-END)  $\rightarrow$  ( $\pm 190.000\text{mV}$ ); at this moment, the correctness work is finished.

2V: Input pan-shape meter short-circuit, press REL button to clear the Zero position; input  $\pm 1.9\text{V}$ , press CAL button, the display will display : (--CAL--)  $\rightarrow$  (-HI-END)  $\rightarrow$  ( $\pm 1.90000\text{V}$ ); at this moment, the correctness work is finished.

20V: Input pan-shape meter short-circuit, press REL button to clear the Zero position; input  $\pm 19\text{V}$ , press CAL button, the display will display : (--CAL--)  $\rightarrow$  (-HI-END)  $\rightarrow$  ( $\pm 19.0000\text{V}$ ); at this moment, the correctness work is finished.

200V: Input pan-shape meter short-circuit, press REL button to clear the Zero position; input  $\pm 190\text{V}$ , press CAL button, the display will display : (--CAL--)  $\rightarrow$  (-HI-END)  $\rightarrow$  ( $\pm 190.000\text{V}$ ); at this moment, the correctness work is finished.

1000V: Input pan-shape meter short-circuit, press REL button to clear the Zero position; input  $\pm 1000\text{V}$ , press CAL button, the display will display : (--CAL--)  $\rightarrow$  (-HI-END)  $\rightarrow$  ( $\pm 1000.000\text{V}$ ); at this moment, the correctness work is finished.

### 2. AC Current (Except the frequency of 750V and 1kHz, the balance is 20KHz).

200mV: Input: 19mV

Press CAL button, it will display (--CAL--)  $\rightarrow$  (-L0-END)  $\rightarrow$  (\*\*\*\*\*);

Input: 190mV

Press CAL button, it will display (--CAL--)  $\rightarrow$  (-HI-END)  $\rightarrow$  (190.000mV); at this moment, the correctness work is finished.

2V: Input: 190mV

Press CAL button, it will display (--CAL--)  $\rightarrow$  (-L0-END)  $\rightarrow$  (\*\*\*\*\*);

Input: 1.9V

Press CAL button, it will display (--CAL--)  $\rightarrow$  (-HI-END)  $\rightarrow$  (1.90000V); at this moment, the correctness work is finished.

## Operating Instruction of UT805A

- 20V: Input: 1.9V  
 Press CAL button, it will display (--CAL--) → (-L0-END) → (\*\*\*\*\*);  
 Input: 19V  
 Press CAL button, it will display (--CAL--) → (-HI-END) → (19.0000V); at this moment, the correctness work is finished.
- 200V: Input: 19V  
 Press CAL button, it will display (--CAL--) → (-L0-END) → (\*\*\*\*\*);  
 Input: 190V  
 Press CAL button, it will display (--CAL--) → (-HI-END) → (190.000V); at this moment, the correctness work is finished.
- 750V: Input: 190V  
 Press CAL button, it will display (--CAL--) → (-L0-END) → (\*\*\*\*\*);  
 Input: 750V  
 Press CAL button, it will display (--CAL--) → (-HI-END) → (750.00V); at this moment, the correctness work is finished.

AC+DC: Input the DC voltage to calibrate as per the AC steps.

### 3. DC Current (The positive and negative polarity should be corrected)

- 2mA: Press REL Button to clear the zero position, enter  $\pm 1.9\text{mA}$ ; press CAL button to display (--CAL--) → (-HI-END) → ( $\pm 1.90000\text{mA}$ ); at this moment, the correctness work is finished.
- 200mA: Press REL Button to clear the zero position, enter  $\pm 190\text{mA}$ ; press CAL button to display (--CAL--) → (-HI-END) → ( $\pm 190.000\text{mA}$ ); at this moment, the correctness work is finished.
- 10A: Press REL Button to clear the zero position, enter  $\pm 10\text{A}$ ; press CAL button to display (--CAL--) → (-HI-END) → ( $\pm 10.0000\text{A}$ ); at this moment, the correctness work is finished.

## 4. AC Current (the frequency is 1KHz)

- 2mA: Input: 0.19mA  
Press CAL button, it will display (--CAL--) → (-L0-END) → (\*\*\*\*\*)  
Input: 1.9mA  
Press CAL button, it will display (--CAL--) → (-HI-END) → (1.9000mA); at this moment, the correctness work is finished.
- 200mA: Input: 19mA  
Press CAL button, it will display (--CAL--) → (-L0-END) → (\*\*\*\*\*)  
Input: 190mA  
Press CAL button, it will display (--CAL--) → (-HI-END) → (190.000mA); at this moment, the correctness work is finished.
- 10A: Input: 1A  
Press CAL button, it will display (--CAL--) → (-L0-END) → (\*\*\*\*\*)  
Input: 10A  
Press CAL button, it will display (--CAL--) → (-HI-END) → (10.0000A); at this moment, the correctness work is finished.

AC+DC: Input the DC current to calibrate as per the AC steps.

## 5. Resistance

- 200 $\Omega$ : Press REL button to clear the zero position; input 190.0 $\Omega$  and press CAL button, it will display (--CAL--) → (-HI-END) → ( 190.000 $\Omega$  ); at this moment, the correctness work is finished.
- 2 K $\Omega$ : Press REL button to clear the zero position; input 1.9K $\Omega$  and press CAL button, it will display (--CAL--) → (-HI-END) → (1.90000 K $\Omega$ ); at this moment, the correctness work is finished.
- 20 K $\Omega$ : Press REL button to clear the zero position; input 19K $\Omega$  and press CAL button, it will display (--CAL--) → (-HI-END) → (19.0000 K $\Omega$ ); at this moment, the correctness work is finished.
- 200 K $\Omega$ : Press REL button to clear the zero position; input 190K $\Omega$  and press CAL button, it will display (--CAL--) → (-HI-END) → (190.000 K $\Omega$ ); at this moment, the correctness work is finished.
- 2 M $\Omega$ : Press REL button to clear the zero position; input 1.9M $\Omega$  and press CAL button, it will display (--CAL--) → (-HI-END) → (1.90000M $\Omega$ ); at this moment, the correctness work is finished.
- 20 M $\Omega$ : Press REL button to clear the zero position; input 19M $\Omega$  and press CAL button, it will display (--CAL--) → (-HI-END) → (19.0000 M $\Omega$ ); at this moment, the correctness work is finished.

## **6. Correctness of AC voltage with the DC offset (AC+DC)**

After pressing “ACV” , and then press “AC+DC” button, the balance calibration steps are as same as the (2) (AC voltage correctness) .

(7) Correctness of AC current with DC offset (AC+DC)  
After pressing “ACI” , and then press “AC+DC” button, the balance calibration steps are as same as the (4) (AC current correctness).

## XI. RS232C Standard serial interface

### A. RS232C interface connection and mounting

#### 1. Connection of instrument and computer (See Figure 15)

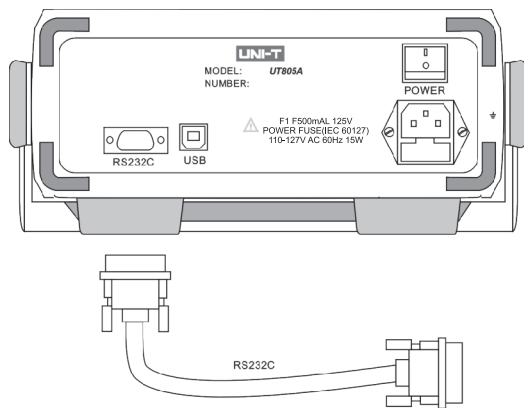

Figure 15

## 2. RS232C interface cable connection:

DMM	COMPUTER	
D-sub 9 Pin Male	D-sub 9 Pin Female	D-sub 25 Pin Female
2 (RXD)	3 (TXD)	2 (TXD)
3 (TXD)	2 (RXD)	3 (RXD)
5 (SG)	5 (SG)	7 (SG)

### B. RS232C Interface setting:

When communicating at the RS232C interface, the default setting is (When running the computer interface software, the software will set the following parameters automatically) the baud rate of RS232 serial interface is 9600bits/S; the one frame information is 10 digits; no odd-even calibration; the start bit is 1 digit (0), 8-digit data (with the low digit onwards) (1), 1 digit stop bit (1).

## Operating Instruction of UT805A

### XII. USB Interface

A. Connection of instrument and computer (See Figure 16)

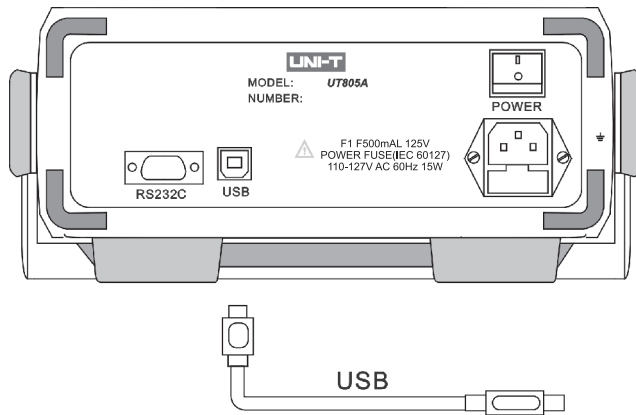

Figure 16

B. USB Interface setting

When connecting the instrument with the USB, it should install the driving program of USB interface firstly; See the Installation File for the details of installation job.

C. It will display USB Serial Port (com X) at the interface of Equipment Manager of the computer; when connecting the computer with the instrument, use the same com X.

## XIII Communication protocol

### 1. Format of data uploaded

#### 1) Function

code	Measurement mode
0x30 (0110000)	DC voltage
0x31 (0110001)	AC voltage
0x32 (0110010)	ACV + DCV
0x33 (0110011)	DCI
0x34 (0110100)	ACI
0x35 (0110101)	ACI+DCI
0x36 (0110110)	Resistance measurement (OHM)
0x37 (0110111)	Capacitor measurement (CAP)
0x38 (0111000)	Frequency (FRQ)
0x39 (0111001)	Short-circuit test (CTN)
0x3a (0111010)	Diode (DIO)

## 2) Main displaying measuring range

code	DCV	ACV&ACV+DCV	DCI	ACI&ACI+DCI	OHM	CAP	FRQ	Other
0110000	200mV	200mV	2mA	2mA	200 Ω		6KHz	No measuring range division
0110001	2V	2V	200mA	200mA	2K Ω	60 nF	60KHz	
0110010	20V	20V	10A	10A	20K Ω	600 nF	600KHz	
0110011	200V	200V			200K Ω	6 μ F	6MHz	
0110100	1000V	750V			2M Ω	60 μ F	60MHz	
0110101					20M Ω	600 μ F		
0110110						6.00mF		



3) The main value displayed is DIGIT7 DIGIT0 (The CTN and DIO is a 5-digit reading; the other is the 6-digit reading; including extra a symbol and a decimal point).

Note: Add “\*” if the digit is less than 6; for instance: DIO sends “00046\*\*” , DCV sends “-190.000”

4) The auxiliary value displayed is DIGIT4-DIGIT0 (4 digits + decimal point)

Note: It will display the corresponding value if there is the auxiliary display; otherwise it will display “\*\*\*\*\*” .

It will only occur auxiliary frequency value when measuring ACV & ACV+DCV & ACI & ACI+DCI, with the unit to be KHz; the other auxiliary display is calculated by PC software.

5) Status

0	1	1		SIGN		OL
---	---	---	--	------	--	----

6) Option1

0	1	1	HOLD	MAX	MIN	AVG
---	---	---	------	-----	-----	-----

Note: When MAX, MIN and AVG is 1 totally, it means the instrument is under the ALL mode for statistics display.

7) Option2

0	1	1	0	0	AUTO	REL
---	---	---	---	---	------	-----

8) Option3

## Operating Instruction of UT805A

0	1	1	RCL	STO	CAL	SETUP
---	---	---	-----	-----	-----	-------

9)CR  
0001101

10)LF  
0001010

## 2. PC order format

The instrument uses the single capital-letter order; when sending an order, it will repeat twice continuously. See the following table:

Order	A	B	C	D	E	F	G	H	I	J	K
Meaning	DCV	ACV	DCI	ACI	OHM	RST	CAP	FRQ	CTN	DIO	SETUP
Order	L	M	N	O	P	Q	R	S	T	U	
Meaning	UP	AUTO	DOWN	HOLD_EXIT	RCL	STO	MAX_MIN	REL	CAL	AC+DC	

After receiving the order sent by computer (the same capital letters), the instrument will send back a same capital letter. When receiving the nonconforming letter order, the instrument will disregard.

## **XIV. Installation and application of interface software**

(See the Operation Description for the Interface Software contained in the accompanying software disc).

## XV.Upkeep and maintenance



### Warning:

Please switch the power source off before opening the top cover of instrument, and make sure the pen-shape meter has already left the input port and the circuit under the measurement.

### 1. General upkeep and maintenance

- 1)After using for 1 year roughly, please calibrate the instrument so as to ensure its working accuracy to meet the given technical indexes;
- 2)When cleaning the instrument, it can only use the wet cloth and a few of cleaning agent; please do not use chemical solvent to clean any part of the instrument;
- 3)If the instrument goes wrong when working, please stop using and send for maintenance immediately;
- 4)When it is a must to calibrate or repair the instrument, please let the qualified professional repairer or the designated maintenance department do the relevant works.

### 2. Replace fuse (See Figure 17)

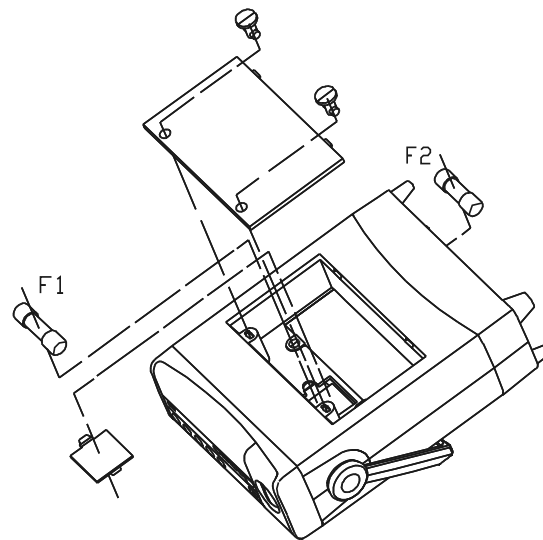

Figure 17

## Operating Instruction of UT805A

### Warning:

When measuring current, please check if the built-in fuse is broken if the instrument has no any reaction. If yes, please replace the fuse with the same specifications.

Fuse specifications:

- F1 F 10A H 250V Quick fuse  $\Phi$ 5X20mm (A)
- F2 F 500mA H 125V Quick fuse  $\Phi$ 5X20mm (AC 110V)

Operating procedures:

- 1)Put the power switch at “Off” position, and remove the plug of power cable from the power socket, and remove the pen-shape meter from the hole;
- 2)Open the fuse cover of power socket, change the broken fuse F2;
- 3)Unscrew the fixing bolts at the top cover by screwdriver, and then remove the top cover; afterwards, it can replace the broken fuse F1.

\*\*\* The Operating Manual will be updated without notice\*\*\*



Operating Instruction of UT805A

©Copyright 2010 Uni-Trend Group Limited.  
All rights reserved.

Manufacturer:  
Uni-Trend Technology (China) Limited  
No 6, Gong Ye Bei 1st Road  
Songshan Lake National High-Tech Industrial  
Development Zone, Dongguan City  
Guangdong Province  
China  
Postal Code: 523 808

Headquarters:  
Uni-Trend Group Limited  
Rm901, 9/F, Nanyang Plaza  
57 Hung To Road  
Kwun Tong  
Kowloon, Hong Kong  
Tel: (852) 2950 9168  
Fax: (852) 2950 9303  
Email: [info@uni-trend.com](mailto:info@uni-trend.com)  
<http://www.uni-trend.com>