



P/N:110401106876X

UNI-T®



UT133A/B

Operating Manual



Digital Multimeter

Table of Content

I. Introduction-----	1
II. Open box inspection-----	2
III.Safety Instructions-----	2
IV.Symbols-----	4
V. General specifications-----	5
VI.Structure-----	7
VII.LCD Display-----	8
VIII.Function dial and buttons-----	9
IX.Operation instructions-----	23
X.Technical specifications-----	24
XI.Maintenance-----	32

I. Introduction

UT133A, B are 6000 count palm sized multimeters with auto and manual range respectively. These CE/ETL certified multimeters are CAT III 600V, which can withstand 6000kV surge voltage. UT133 are designed with high voltage warning and over range alarm, making this series great for a wide range of measurement needs.

Features:

- Smart appearance with comfy handle
- Pass 2-meter drop test
- Large LCD screen with 6000 counts display, true RMS measurement, fast ADC digital converter (4 times/s)
- Overload protection with alert
- Extensive range for capacitance measurement, short response time. E.g. When measuring $\leq 10\text{mF}$, response time $\leq 6\text{s}$
- Support NCV, frequency (UT133A) and battery (UT133B) measurement.
- Support up to 600V/10A AC/DC current and voltage measurement.
- Backlight installed for dim occasions.
- Energy saving

II. Open Box Inspection

Open the package box and take out the device. Please check whether the following items are deficient or damaged and contact your supplier immediately if they are.


- User manual -----1 pc
- Test leads-----1 pair
- K-type thermocouple-----1 pc (UT133A Only)

III. Safety Instructions










Safety Standards

- CE, cETLus
- EN 61326-1:2013; EN 61326-2-2:2013
- EN 61010-1:2010; EN 61010-2-030:2010; EN 61010-2-033:2012ns
- Conforms to UL STD. 61010-1, 61010-2-030, 61010-2-033, Certified to CSA STD. C22.2 No. 61010-1, 61010-2-030, 61010-2-033.
- CAT III 600V, double insulation standard, over voltage standard, and RoHS, pollution grade II

Safety Instructions

- 1) Do not use the device if the rear cover is not covered up or it will pose a shock hazard
- 2) Do not use the device if the device or test leads appear damaged or if you suspect that the device is not operating properly. Pay particular attention to the insulation layers.
- 3) During measurement, keep your fingers behind the finger guard.
- 4) Do not input over 600V voltage between the device and the grounding.
- 5) Use caution to measure voltage >DC 60V or AC 30Vrms.
- 6) Never input voltage and current exceeding the value listed on the device.
- 7) Functional dial should be switched to proper position.
- 8) Do not switch the functional dial during measuring.
- 9) Do not change the internal circuit of the device in order to avoid the damage to the device and users.
- 10) Replace the fuse with the specified model.
- 11) To avoid false reading, replace the battery when the battery indicator  appears.
- 12) Do not use or store the device in high temperature, high humidity, flammable, explosive or strong magnetic field environments.
- 13) Use damp cloth to clean the case; do not use detergent containing solvents or abrasives.
- 14) Before each use verify meter operation by measuring a known voltage or current. If the equipment is used in a manner not specified by the manufacturer, the protection provided by the equipment may be impaired.



IV. Symbols

	Low battery
	Direct current
	Alternating current
	Warning
	Double insulation
	Caution, possibility of electric shock
	Grounding
	Comply with European Union Standards
	cETLus Certification
CAT III	It is applicable to test and measuring circuits connected to the distribution part of the building's low-voltage MAINS installation.

V. General specifications

- 1) Max voltage between input terminal and earth grounding: 600Vrms
- 2) Fuse Type:
 - 10A Jack: F 10A H 600V Fuse $\Phi 6 \times 25 \text{mm}$ (or $\Phi 6 \times 32 \text{mm}$)
 - mA/ μA Jack: F 600mA H 600V Fuse $\Phi 6 \times 32 \text{mm}$
- 3) Display count: 6000
 - Overload indication: OL, refresh 3~4 times/s

Others:

- 1) Range: Auto UT133A/Manual UT133B
- 2) Backlight: Manual, shutdown after 30s.
- 3) Polarity: — for negative pole
- 4) Data hold indication: 
- 5) Low power indication: 

- 6) Operating temperature: $0^{\circ}\text{C} \sim 40^{\circ}\text{C}$ ($32^{\circ}\text{F} \sim 104^{\circ}\text{F}$)
 - Storage temperature: $-10^{\circ}\text{C} \sim 50^{\circ}\text{C}$ ($14^{\circ}\text{F} \sim 122^{\circ}\text{F}$)
 - Relative humidity: $\leq 75\%$ at $0^{\circ}\text{C} \sim 30^{\circ}\text{C}$; $\leq 50\%$ at $30^{\circ}\text{C} \sim 40^{\circ}\text{C}$
- 7) Operating altitude: 0~2000m
- 8) Battery type: AAA 1.5V $\times 2$
- 9) Dimension: 155mm $\times 76.5\text{mm} \times 49\text{mm}$
- 10) Weight: 255g(with batteries)
- 11) Electromagnetic compatibility:
 - RF $\leq 1\text{V/m}$, overall accuracy=specified accuracy+5% of range.
 - RF $> 1\text{V/m}$, no specified calculation.

VI. Structure(see figure 1)

1. LCD display
2. Functional buttons
3. Functional dial
4. 10A input terminal
5. COM input terminal
6. Other input terminals

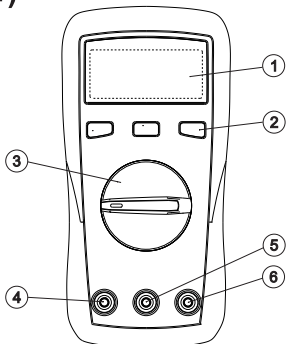


Figure 1

VII. Buttons



UT133A:

- *.**SELECT** : Cycle switch the functions through AC/DC mV range, frequency, resistance /diode/ continuity, °C/°F
- *.**REL** : The voltage, current and capacitance mode, press this button to remove the base.
- *.**HOLD/LIGHT** : Press the button once to hold the reading. Press this button for 2 seconds to turn on/off the backlight.

UT133B:

- *.**HOLD/SELECT** : Press to turn on/off data hold function (except at continuity/diode position)
- *.**REL** : The capacitance mode, press this button to remove the base.
- *.**LIGHT**: Press this button to turn on/off the backlight.

VIII. Operation instructions

To avoid false reading, replace the battery if the battery low power symbol  appears. Also pay special attention to the warning sign  besides the test lead housing, indicating that the tested voltage or current must not exceed the values listed on the device.

1. AC/DC voltage measurement (see Figure 2)

- 1) Switch the dial to ACV position
- 2) Insert the red test lead to V Ω mA jack, black to COM jack.
- 3) Connect test leads with the load in parallel.
- 4) At mV position, press SELECT to enter frequency measurement (10Hz~1MHz)
- 5) Reading is displayed.

Warnings

- Do not input voltage over 600Vrms, or it may pose shock hazard.
- Be cautious when measuring high voltage

Note:

- Before using the device, if the voltage is unknown, switch the dial to the maximum range position and reduce the range according to the practical reading.
- Test a known voltage to verify the device.
- When input impedance about 10M Ω , there may be errors when measurement high voltage. Input impedance $\leq 10k\Omega$, measurement errors can be ignored ($\leq 0.1\%$)

2. Resistance measurement.

- 1) Switch the dial to resistance position
- 2) Insert the red test lead to V Ω mA jack, black to COM jack.
- 3) Connect test leads with the load in parallel.
- 4) Reading is displayed.

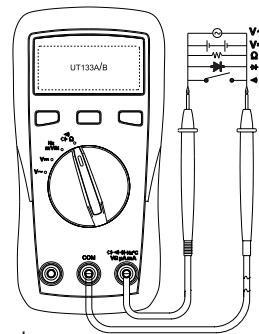


Figure 2

▲ Notes:

- If the resistor is open or over the range, the “OL” symbol will be displayed on the screen.
- Before measuring resistance, switch off the power supply of the circuit, and fully discharge all capacitors.
- When measuring low resistance, the test leads will produce 0.1Ω~0.2Ω measurement error. To obtain accurate measurement, short the test leads and use REL function.
- If the resistance when shorted is more than 0.5Ω, please check if test leads are loosened or damaged.
- Resistance measurement can be used to inspect device’s internal fuses.(see figure 4b)
- Do not input over 60V DC or 30V AC or it will pose shock hazard.

3.Continuity measurement (see figure 2)

- 1) Switch the dial to continuity position
- 2) Insert the red test lead to VΩmA jack, black to COM jack.
- 3) Connect test leads with the load in parallel.
- 4) Reading is displayed. Measured resistance >51Ω, circuit is in open status.
Measured resistance ≤10Ω, circuit is in good conduction status, buzzer will go off

▲ Warnings:

Switch off the power supply to the circuit, and fully discharge all capacitors

4.Diode measurement (see figure 2)

- 1) Switch the dial to diode position
- 2) Insert the red test lead to VΩmA jack, black to COM jack.
- 3) Red test lead to positive pole, black to negative pole.
- 4) Reading is displayed.
- 5) “OL” symbol appears when the diode is open or polarity is reversed. For silicon PN junction, normal value: 500 ~ 800mV (0.5 ~ 0.8V).

▲ Notes:

Switch off the power supply to the circuit, and fully discharge all capacitors
Voltage for testing diode is about 4.0V/1.5mA.

5. Capacitance measurement (see figure 3)

- 1) Switch the dial to capacitance measurement
- 2) Insert the red test lead to V Ω mA jack, black to COM jack.
- 3) Reading is displayed.

⚠ Notes:

- Switch off the power supply to the circuit, and fully discharge all capacitors
- Before measuring capacitors (especially for high voltage capacitors), please fully discharge them.
- If the tested capacitor is shorted or its capacity is over the specified range "OL" symbol will be displayed on the screen.
- When measuring large capacitors, it may take a few seconds to obtain steady readings.
- When there is no input, the device displays a fixed value (intrinsic capacitance).
- For small capacitance measurement, to ensure measurement accuracy, the measured value must be subtracted from intrinsic capacitance. Or users can measure small capacity capacitors with relative measurement function (REL) (the device will automatically subtract the intrinsic capacitance)

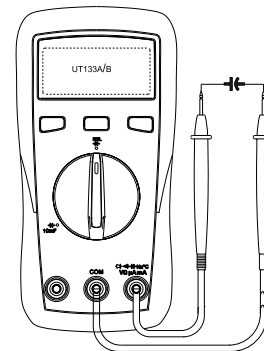


Figure 3

6. AC/DC current measurement (AC current measurement is only for UT133A)

- 1) Switch the dial to AC/DC current position
- 2) According to the current being measured. Insert the red test lead to V Ω mA jack or 10A jack, black to COM jack.
- 3) Connect test leads with the circuit in series
- 4) Reading is displayed.

⚠ Notes:

- Before measuring, switch off the power supply of the circuit.
- If the range of the measured current is unknown, select the maximum range and then accordingly reduce.
- There are fuses inside V Ω mA jack and 10A jack. Do not connect the test leads with any circuits in parallel.
- If the tested current is about 10A, each measurement time is about 10 seconds (less than 30s) and the next test should be after 15 minutes.

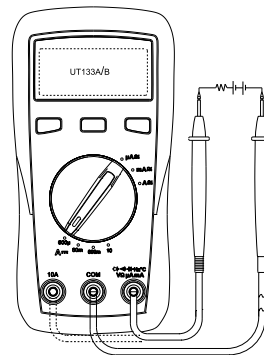


Figure 4

7. Battery measurement (Only for UT133B)

- 1) Switch the dial to battery position
- 2) Insert the red test lead to VΩmA jack or 10A jack, black to COM jack.
- 3) Connect red test lead to + pole of the battery, black to – pole.
- 4) Reading is displayed (Good-normal status; Low-low power; Bad-need replacement)
- 5) LCD display of battery status

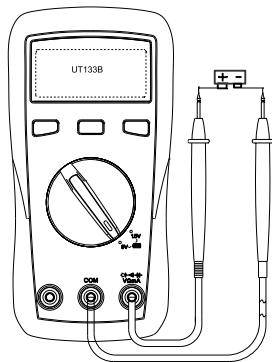
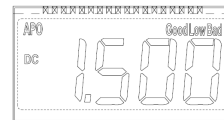


Figure 5

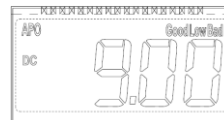
1.5V battery: resistance=30Ω

Indication	Voltage
Good	≥ 1.31
Low	0.95V~1.3V
Bad	$\leq 0.94V$



9V battery: resistance=900Ω

Indication	Voltage
Good	≥ 7.8
Low	5.7V~7.7V
Bad	$\leq 5.6V$



⚠ Note:

- When the display shows Bad, you need to replace the battery
- If the battery voltage $< 0.2V$, there is no indication on the display, LCD only shows the flashing voltage value
- Do not input over 60V DC or 30V AC voltage.

8. Temperature measurement (Only for UT133A)

- 1) Switch the dial to temperature position
- 2) Insert K-type thermocouple to the device and place the test probes on the object under measurement.
- 3) Reading is displayed.

⚠ Note

- Only K-type thermocouple is applicable.
- The measured temperature should be less than 250°C/482°F ($^{\circ}\text{F} = ^{\circ}\text{C} \times 1.8 + 32$)
- Turn on the device, after "OL" symbol appears, insert K-thermocouple into the device.

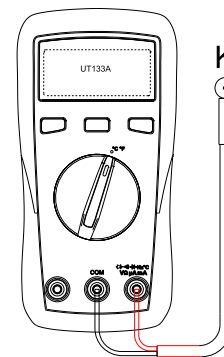


Figure 6

9. NCV measurement (see figure 7)

- 1) Switch the dial to NCV position
- 2) Place the device near the measured object. "--" symbol indicates the intensity of the electric field. More "--" and the higher the buzzer frequency, the higher the electric field intensity.

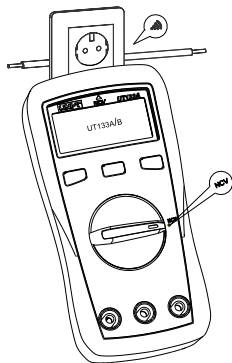
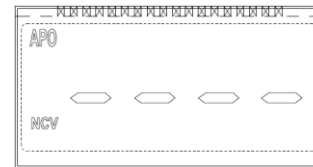
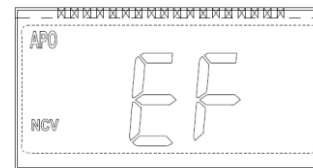


Figure 7

3) Intensity of electric field.


- * "EF": 0 ~ 50mV
- * "--": 50 ~ 100mV
- * "---": 100 ~ 150mV
- * "----": 150 ~ 200mV
- * "-----": >200mV



IX. Others

- The device enters measurement status in 2 seconds after startup. Restart the device if "ErrE" appears.
- The device automatically shuts down if there is no operation for 15 minutes. You can wake up the device by pressing any key.
To disable auto shutdown: switch the dial to OFF position and long press SELETE button until the device turn on.

Buzzer notification

- 1) Input voltage $\geq 600V$ (AC/DC), buzzer will continuously beep indicating measure range is at limit
 - 2) Input current $> 10A$ (AC/DC), buzzer will continuously beep indicating measure range is at limit
 - 3) The buzzer will go off five times continuously 1 minute before auto-off.
- Low power warnings:
Voltage of the battery $< 2.5V$,  symbol appears

X. Technical specifications

Accuracy: \pm (% of reading + numerical value in least significant digit slot), 1 year warranty

Ambient temperature: $23^{\circ}C \pm 5^{\circ}C$ ($73.4^{\circ}F \pm 9^{\circ}F$)

Ambient humidity: $\leq 75\%$ RH

⚠ Notes

To ensure accuracy, operating temperature should be within $18^{\circ}C \sim 28^{\circ}C$.

Temperature Coefficient = $0.1 * (\text{specified accuracy}) / ^{\circ}C$ ($< 18^{\circ}C$ or $> 28^{\circ}C$)

1. DC voltage

Range		Resolution	Accuracy
Position	Model		
600.0mV	UT133A/B	0.1mV	$\pm(0.7\%+3)$
6.000V/6000mV	UT133A/B	0.001V/1mV	$\pm(0.5\%+2)$
60.00V	UT133A/B	0.01V	$\pm(0.7\%+3)$
600.0V	UT133A/B	0.1V	$\pm(0.7\%+3)$

⚠ Input impedance: About 10MΩ.

Results might be unstable at mV range when no load is connected. The value becomes stable once the load is connected. Least significant digit $\leq \pm 3$

Max input voltage: $\pm 600V$, when the voltage $\geq 610V$, "OL" symbol appears and the buzzer goes off.

Overload protection: 600Vrms (AC/DC)

2.AC voltage

Range		Resolution	Accuracy
Position	Model		
600.0mV	UT133A	0.1mV	$\pm(1.0\%+2)$
6.000V	UT133A	0.001V	$\pm(0.7\%+3)$
60.00V	UT133A	0.01V	$\pm(1.0\%+2)$
600.0V	UT133A/B	0.1V	$\pm(1.2\%+3)$

⚠ Input impedance: about 10MΩ

Display sine wave true RMS. Frequency response: 40Hz ~ 400Hz

Max input voltage: 600Vrms. when the voltage $\geq 610V$, "OL" symbol appears and the buzzer goes off.

Overload protection: 600Vrms (AC/DC)



3.Resistance measurement.

Range		Resolution	Accuracy
Position	Model		
600.0Ω	UT133A/B	0.1Ω	$\pm(1.0\%+2)$
6.000kΩ/6000Ω	UT133A/B	0.1kΩ/1Ω	$\pm(0.8\%+2)$
60.00kΩ	UT133A/B	0.01kΩ	$\pm(0.8\%+2)$
600.0kΩ	UT133A/B	0.1kΩ	$\pm(0.8\%+2)$
60.00MΩ	UT133A/B	0.01MΩ	$\pm(2.0\%+5)$

⚠ Measurement result = reading of resistor – reading of shorted test leads

Overload protection: 600Vrms


4. Continuity, Diode

Position	Resolution	Remark
	0.1Ω	Set Value Open circuit: resistance > 50Ω, no beep. Well-connected circuit: resistance ≤ 10Ω, continuous beeps.
	0.001V	UT133A Open circuit voltage : 4V , test current: about 1.5mA UT133B Open circuit voltage : 2.1V , test current: about 1mA Silicon PN junction voltage: 0.5 ~ 0.8V.

 Overload protection: 600Vrms

5. Capacitance

Range	Resolution	Accuracy
9.999nF	0.001nF	REL mode : ±(4%+10)
99.99nF	0.01nF	±(4%+5)
999.9nF	0.1nF	±(4%+5)
9.999μF	0.001μF	±(4%+5)
99.99μF	0.01μF	±(4%+5)
999.9μF	0.1μF	±(4%+5)
9.999mF	0.001mF	±10%

 Overload protection: 600V-PTC
Test capacitance ≤ 200nF, adapt REL mode.

6. Temperature (Only for 133A)

Range		Resolution	Accuracy
°C	-40~1000°C	-40~40°	±4 °C
		>40~500°C	±(1.0%+4)
		>500~1000°C	±(2.0%+4)
°F	-40~1832°F	-40~104°F	±5 °F
		>104~932°F	±(1.5%+5)
		>932~1832°F	±(2.5%+5)

⚠ Overload protection: 600V

K-type thermocouple is only applicable for temperature less than 250°C/482°F.

7. DC current

Range		Resolution	Accuracy
Position	Model		
600.0μA	UT133A/B	0.1μA	±(1.0%+3)
6000μA	UT133A	1μA	±(1.0%+3)
60.00mA	UT133A/B	0.01mA	±(1.0%+3)
600.0mA	UT133A/B	0.1mA	±(1.0%+3)
6A	UT133A	0.001A	±(1.2%+5)
10.00A	UT133A/B	0.01A	±(1.2%+5)

⚠ Overload protection: 600Vrms

μA mA range: F1 Fuse Φ6×32mm F 600mA H 600V

10A range: F2 Fuse Φ6×25mm (or Φ6×32mm) F 10A H 600V

Input current ≥ 10A, buzzer goes off; input current > 10.10A "OL" symbol appears

9. AC current (Only for UT133A)

Range		Resolution	Accuracy
Position	Model		
600.0μA	UT133A	0.1μA	±(1.2%+3)
6000μA		1μA	
60.00mA		0.01mA	
600.0mA		0.1mA	
6A		0.001A	±(1.5%+5)
10.00A		0.01A	

Frequency response: 40~400Hz

Display: true RMS

Accuracy guarantee range: 5-100% of the range, shorted circuit allows least significant digit ≤ 2

Input current ≥ 10A, buzzer goes off; input current > 10.10A "OL" symbol appears

⚠ Overload protection: (similar to DC current)

XI. maintenance

⚠ **WARNING:** To avoid electric shock, make sure the probes are disconnected from the measured circuit before removing the rear cover.

Make sure the rear cover is tightly screwed before using the instrument.

1. General maintenance

- 1) Clean the case with a damp cloth and detergent. Do not use abrasives or solvents
- 2) If there is any malfunction, stop using the device and send it to maintenance.
- 3) The maintenance and service must be implemented by qualified professionals or designated departments.

2. Replacements (see Figure 8a, Figure 8b)

Battery replacement:

To avoid false reading, replace the battery when the battery indicator appears.

Battery Specification: AAA 1.5V x 2

- 1) Switch the dial to "OFF" position and remove the test leads from the input terminal.
- 2) Take off the protective case. Loosen the screw on battery cover; remove the cover to replace the battery. Please identify the positive and negative pole.

Fuse replacement:

- 1) Switch the dial to "OFF" position and remove the test leads from the input terminal
- 2) Loosen the both screws on the rear cover, and then remove the rear cover to replace the fuse

Fuse specification

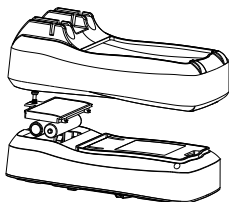
F1 Fuse $\Phi 6 \times 32\text{mm}$ F 600mA H 600VF2 Fuse $\Phi 6 \times 25\text{mm}$ (or $\Phi 6 \times 32\text{mm}$) F 10A H 600V

Figure 8a

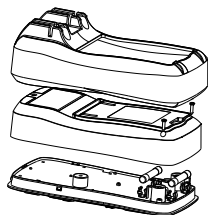


Figure 8b

Test probe replacement

If insulation on probe is damaged, replace it.

⚠WARNING:

If the test leads need to be replaced, you must use a new one which should meet EN 61010-031 standard, rated CAT III 600V, 10A or better.

Manufacturer:

No.6, Gong Ye Bei 1st Road,
Songshan Lake National High-Tech Industrial
Development Zone, Dongguan City,
Guangdong Province, China
Tel: (86-769) 8572 3888
Fax: (86-769) 8572 5888
Postal Code: 523 808
<http://www.uni-trend.com>

Headquarters:

Rm 901,9/F,Nanyang Plaza,57 Hung To
Road, Kwun Tong, Kowloon,Hong Kong