

R&S® RTM3000

Oscilloscope

User Manual

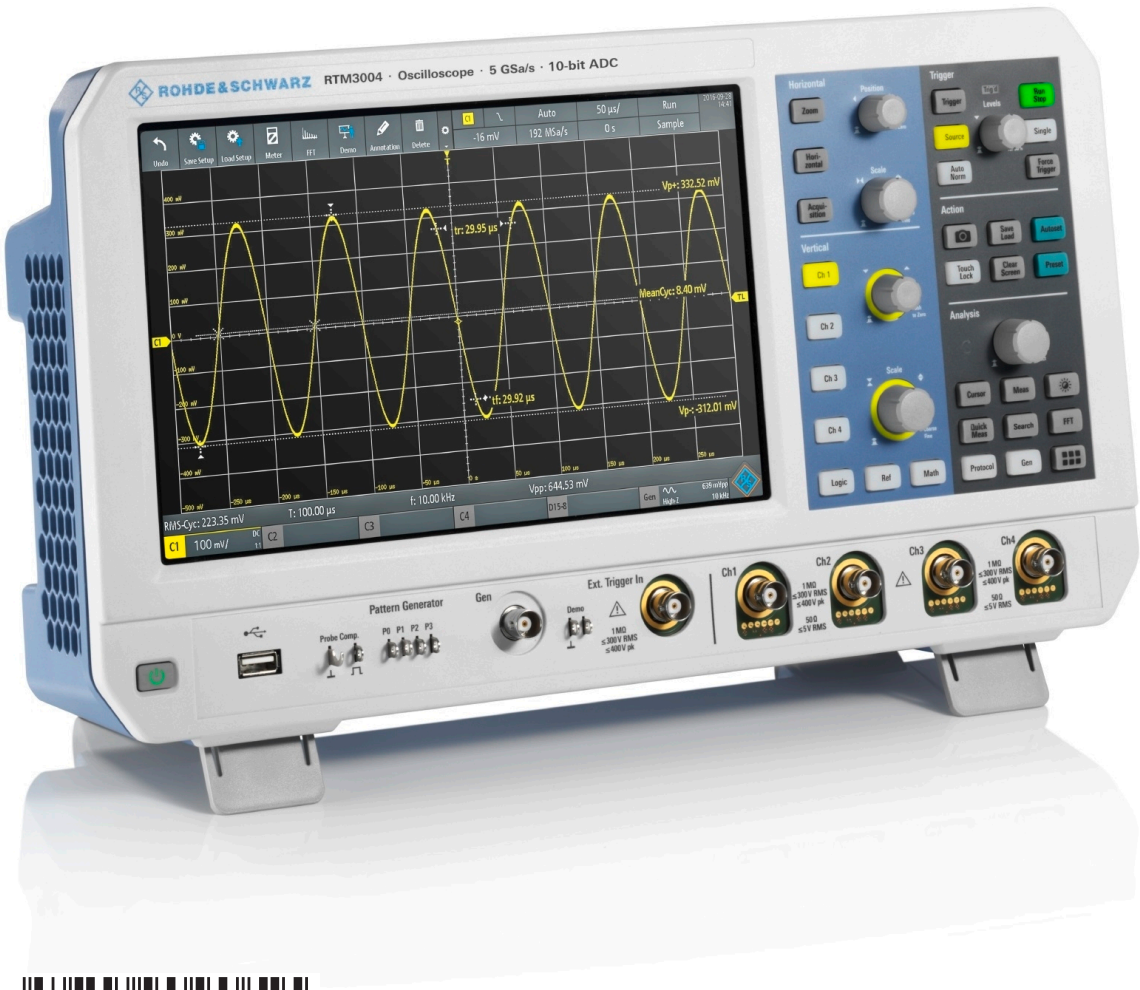

1335909002

This manual describes the following R&S®RTM3000 models with firmware version 1.5xx:

- R&S®RTM3002 (1335.8794K02)
- R&S®RTM3004 (1335.8794K04)

© 2019 Rohde & Schwarz GmbH & Co. KG

Mühlhofstr. 15, 81671 München, Germany

Phone: +49 89 41 29 - 0

Fax: +49 89 41 29 12 164

Email: info@rohde-schwarz.com

Internet: www.rohde-schwarz.com

Subject to change – Data without tolerance limits is not binding.

R&S® is a registered trademark of Rohde & Schwarz GmbH & Co. KG.

Trade names are trademarks of the owners.

1335.9090.02 | Version 06 | R&S®RTM3000

Throughout this manual, products from Rohde & Schwarz are indicated without the ® symbol, e.g. R&S®RTM3000 is indicated as R&S RTM3000.

Contents

1	Preface	17
1.1	Safety Information	17
1.2	Documentation Overview	18
1.2.1	Manuals and Instrument Help.....	18
1.2.2	Data Sheet and Brochure.....	19
1.2.3	Calibration Certificate.....	19
1.2.4	Release Notes and Open Source Acknowledgment.....	19
1.3	Conventions Used in the Documentation	20
1.3.1	Typographical Conventions.....	20
1.3.2	Conventions for Procedure Descriptions.....	20
1.3.3	Notes on Screenshots.....	20
2	Getting Started	21
2.1	Preparing for Use	21
2.1.1	Unpacking and Checking the Instrument.....	21
2.1.2	Positioning the Instrument.....	21
2.1.3	Starting the Instrument.....	22
2.1.4	Replacing the Fuse.....	24
2.2	Instrument Tour	24
2.2.1	Front View.....	24
2.2.2	Side View.....	28
2.2.3	Rear View.....	28
3	Operating Basics	31
3.1	Display Overview	31
3.2	Selecting the Application	32
3.3	Using the Touchscreen	32
3.3.1	Accessing Functionality Using the Main Menu.....	32
3.3.2	Accessing Functionality Using Shortcuts.....	34
3.3.3	Entering Data.....	34
3.3.4	Using Gestures.....	35
3.4	Front Panel Keys	36
3.4.1	Action Controls.....	36

3.4.2	Analysis Controls.....	37
3.5	Using the Toolbar.....	38
3.6	Quick Access.....	39
3.7	Menu History.....	40
3.8	Getting Help.....	41
4	Waveform Setup.....	42
4.1	Connecting Probes and Displaying a Signal.....	42
4.2	Adjusting Passive Probes.....	43
4.3	Vertical Setup.....	44
4.3.1	VERTICAL Controls.....	45
4.3.2	Short Menu for Analog Channels.....	46
4.3.3	Vertical Settings.....	47
4.3.4	Probe Settings for Probes with BNC Connector.....	52
4.3.5	Probe Settings for Probes with Rohde & Schwarz Interface.....	53
4.3.6	Threshold Settings.....	60
4.3.7	Label Settings.....	61
4.4	Horizontal Setup.....	62
4.4.1	HORIZONTAL Controls.....	63
4.4.2	Shortcuts for Horizontal Settings.....	64
4.4.3	Horizontal Settings.....	65
4.5	Acquisition Setup.....	66
4.5.1	Shortcuts for Acquisition Settings.....	66
4.5.2	Acquisition Settings.....	67
5	Trigger.....	71
5.1	Trigger Controls.....	72
5.2	Shortcuts for Trigger Settings.....	73
5.3	General Trigger Settings.....	74
5.4	Edge Trigger.....	76
5.5	Edge A/B Trigger.....	78
5.6	Width Trigger.....	79
5.7	Video Trigger.....	82
5.8	Pattern Trigger.....	84
5.9	Runt Trigger.....	87

5.10	Rise Time Trigger.....	88
5.11	Timeout Trigger.....	90
5.12	Trigger Out Signal.....	92
6	Waveform Analysis.....	93
6.1	Zoom.....	93
6.1.1	Zooming In.....	93
6.1.2	Modifying the Zoom.....	95
6.1.3	Zoom Settings.....	96
6.2	Mathematics.....	97
6.2.1	Short Menu for Math Waveforms.....	97
6.2.2	Configuring Math Waveforms.....	98
6.2.3	Settings for Math Waveforms.....	98
6.2.4	Mathematic Functions.....	99
6.2.5	Filters.....	101
6.2.6	Tracks.....	102
6.2.7	Saving and Loading Formularies.....	107
6.3	Reference Waveforms.....	107
6.3.1	Using References.....	108
6.3.2	Settings for Reference Waveforms.....	109
6.4	History and Segmented Memory (Option R&S RTM-K15).....	112
6.4.1	Segmented Memory.....	112
6.4.2	Activating the History.....	114
6.4.3	History Settings.....	114
6.4.4	Segment Table and History Player.....	116
6.4.5	Exporting History Data.....	118
6.5	Search.....	121
6.5.1	Search Conditions and Results.....	121
6.5.2	General Search Settings.....	124
6.5.3	Edge Search.....	126
6.5.4	Width Search.....	127
6.5.5	Peak Search.....	128
6.5.6	Rise/Fall Time Search.....	129
6.5.7	Runt Setup.....	130

6.5.8	Data2Clock.....	132
6.5.9	Pattern Search.....	133
6.5.10	Window Search.....	135
7	Measurements.....	138
7.1	Quick Measurements.....	138
7.2	Automatic Measurements.....	139
7.2.1	Measurement Results.....	139
7.2.2	Measurement Types.....	141
7.2.3	Settings for Automatic Measurements.....	145
7.3	Cursor Measurements.....	148
7.3.1	Cursor Settings.....	150
8	Applications.....	155
8.1	Mask Testing.....	155
8.1.1	About Masks and Mask Testing.....	155
8.1.2	Using Masks.....	156
8.1.3	Mask Window.....	159
8.1.4	Mask Menu.....	160
8.2	FFT Analysis.....	163
8.2.1	FFT Display.....	163
8.2.2	Performing FFT Analysis.....	165
8.2.3	FFT Setup.....	165
8.3	Spectrum Analysis and Spectrogram (Option R&S RTM-K18).....	171
8.3.1	FFT Menu with R&S RTM-K18.....	171
8.3.2	Spectrum Mode.....	173
8.3.3	Spectrogram.....	174
8.3.4	Peak List and Markers.....	175
8.3.5	Display Settings for Spectrum and Spectrogram.....	181
8.4	XY-Diagram.....	182
8.5	Digital Voltmeter.....	184
8.5.1	Using the Meter.....	185
8.5.2	Meter Settings.....	185
8.6	Trigger Counter.....	186
8.7	Bode Plot (Option R&S RTM-K36).....	187

8.7.1	About the Bode Plot.....	188
8.7.2	Using a Bode Plot.....	189
8.7.3	Bode Plot Window Controls.....	191
8.7.4	Bode Plot Settings.....	192
9	Documenting Results.....	196
9.1	Saving and Loading Instrument Settings.....	197
9.2	Saving Waveform Data.....	198
9.2.1	Waveform Export Settings.....	199
9.2.2	Waveform File Formats.....	200
9.3	Annotations.....	202
9.4	Screenshots.....	203
9.5	Quick Save with OneTouch.....	205
9.6	Export and Import.....	206
10	General Instrument Setup.....	208
10.1	Instrument Settings.....	208
10.2	Display Settings.....	211
10.3	Reset.....	214
10.4	Locking the Touchscreen.....	215
10.5	Performing a Self-Alignment.....	215
10.6	Setting the Data, Time and Language.....	216
10.7	Options.....	217
10.7.1	Activating Options.....	218
10.8	Updating the Firmware.....	218
11	Network Connections and Remote Operation.....	220
11.1	LAN Connection.....	220
11.2	USB Connection.....	223
11.2.1	USB TMC.....	223
11.2.2	USB VCP.....	224
11.2.3	USB MTP.....	224
11.3	Remote Access Using a Web Browser.....	224
11.3.1	Accessing the Instrument Using a Web Browser.....	224
11.3.2	Instrument Home.....	225

11.3.3	Screenshot.....	225
11.3.4	SCPI Device Control.....	226
11.3.5	Save/Load.....	227
11.3.6	Network Settings.....	228
11.3.7	Change Password.....	229
11.3.8	Livescreen.....	229
11.3.9	Remote Front Panel.....	229
12	Serial Bus Analysis.....	230
12.1	Basics of Protocol Analysis.....	230
12.1.1	Protocol - Common Settings.....	231
12.1.2	Displaying Decode Results.....	233
12.1.3	Bus Table: Decode Results.....	234
12.1.4	Bus Labels.....	236
12.1.5	Label List.....	237
12.2	SPI Bus (Option R&S RTM-K1).....	240
12.2.1	The SPI Protocol.....	240
12.2.2	SPI Configuration.....	241
12.2.3	SPI Trigger.....	244
12.2.4	SPI Decode Results	247
12.3	I²C (Option R&S RTM-K1).....	248
12.3.1	The I ² C Protocol.....	249
12.3.2	I ² C Configuration.....	250
12.3.3	I ² C Trigger.....	252
12.3.4	I ² C Decode Results	255
12.3.5	I ² C Label List.....	256
12.4	UART / RS232 (Option R&S RTM-K2).....	258
12.4.1	The UART / RS232 Interface.....	258
12.4.2	UART Configuration.....	258
12.4.3	UART Trigger.....	261
12.4.4	UART Decode Results	263
12.5	CAN (Option R&S RTM-K3).....	264
12.5.1	The CAN Protocol.....	265
12.5.2	CAN Configuration.....	266

12.5.3	CAN Trigger.....	268
12.5.4	CAN Decode Results.....	272
12.5.5	Search on Decoded CAN Data.....	274
12.5.6	CAN Label List.....	276
12.6	LIN (Option R&S RTM-K3).....	278
12.6.1	The LIN Protocol.....	278
12.6.2	LIN Configuration.....	280
12.6.3	LIN Trigger.....	282
12.6.4	LIN Decode Results	285
12.6.5	Search on Decoded LIN Data.....	286
12.6.6	LIN Label List.....	289
12.7	Audio Signals (Option R&S RTM-K5).....	291
12.7.1	Audio Protocols.....	291
12.7.2	Audio Configuration.....	293
12.7.3	Setup of Audio Variants.....	296
12.7.4	Audio Trigger.....	298
12.7.5	Audio Decode Results	300
12.8	MIL-STD-1553 (Option R&S RTM-K6).....	300
12.8.1	The MIL-STD-1553	301
12.8.2	MIL-STD-1553 Configuration.....	303
12.8.3	MIL-STD-1553 Trigger.....	305
12.8.4	MIL-STD-1553 Decode Results.....	310
12.8.5	MIL-STD-1553 Label List.....	311
12.9	ARINC 429 (Option R&S RTM-K7).....	311
12.9.1	ARINC 429 Basics.....	311
12.9.2	ARINC 429 Configuration.....	312
12.9.3	ARINC 429 Trigger.....	314
12.9.4	ARINC 429 Decode Results.....	318
12.9.5	Search on Decoded ARINC 429 Data.....	319
12.9.6	ARINC 429 Label List.....	321
13	Power Analysis (Option R&S RTM-K31).....	323
13.1	Probe Adjustment.....	323
13.1.1	Deskewing the Probes.....	323

13.1.2	Probe Settings for Power Measurements.....	324
13.2	Report Settings.....	324
13.3	Statistic Menu Settings.....	325
13.4	Input Power Measurements.....	326
13.4.1	Quality.....	326
13.4.2	Consumption.....	330
13.4.3	Harmonics.....	333
13.4.4	Inrush Current.....	336
13.5	Output Power Measurements.....	339
13.5.1	Ripple.....	339
13.5.2	Spectrum.....	342
13.5.3	Transient Response.....	345
13.6	Switching Power Measurements.....	347
13.6.1	Slew Rate.....	348
13.6.2	Modulation.....	350
13.6.3	Dynamic On Resistance.....	353
13.7	Power Path Power Measurements.....	355
13.7.1	Efficiency.....	355
13.7.2	Switching Loss.....	358
13.7.3	Turn ON/OFF Time.....	361
13.7.4	Safe Operating Area (S.O.A.).....	364
14	Logic Analyzer (Option R&S RTM-B1, MSO).....	372
14.1	Short Menu for Logic Channels.....	372
14.2	Logic Analyzer Settings.....	374
14.3	Triggering on Logic Channels.....	376
14.4	Analyzing Logic Channels.....	376
14.5	Parallel Buses.....	377
14.5.1	Parallel Bus Configuration.....	377
14.5.2	Decode Results.....	379
15	Signal Generation (Option R&S RTM-B6).....	381
15.1	Function Generator.....	381
15.1.1	Using the Function Generator.....	381
15.1.2	Basic Settings of the Function Generator	384

15.1.3	Sweep Settings.....	387
15.1.4	Modulation Settings.....	388
15.1.5	Burst Settings.....	390
15.1.6	Arbitrary Setup Settings.....	391
15.2	Pattern Generator.....	394
15.2.1	Pattern Selection.....	394
15.2.2	Settings for Square Wave Pattern.....	395
15.2.3	Settings for Counter Pattern.....	396
15.2.4	Settings for Arbitrary Pattern.....	396
15.2.5	Settings for Manual Pattern.....	400
15.2.6	Settings for Serial Buses.....	400
15.2.7	Settings for PWM Signals.....	401
16	Remote Control Commands.....	404
16.1	Conventions used in Command Description.....	404
16.2	Programming Examples.....	405
16.2.1	Documenting Results.....	405
16.2.2	Firmware Update.....	409
16.2.3	Search.....	410
16.2.4	Function Generator.....	411
16.3	Common Commands.....	411
16.4	Waveform Setup.....	414
16.4.1	Automatic Setup.....	415
16.4.2	Starting and Stopping Acquisition.....	415
16.4.3	Vertical Settings.....	416
16.4.4	Passive Probes.....	423
16.4.5	Active Probes.....	424
16.4.6	Horizontal Settings.....	429
16.4.7	Acquisition Settings.....	431
16.4.8	Waveform Data.....	435
16.5	Trigger.....	436
16.5.1	General Trigger Settings.....	436
16.5.2	Edge Trigger.....	438
16.5.3	Edge A/B Trigger.....	440

16.5.4	Width Trigger.....	441
16.5.5	Video/TV Trigger.....	443
16.5.6	Pattern Trigger.....	444
16.5.7	Runt Trigger.....	447
16.5.8	Risetime Trigger.....	448
16.5.9	Timeout Trigger.....	450
16.5.10	Serial Bus.....	451
	16.6 Waveform Analysis.....	451
16.6.1	Zoom.....	451
16.6.2	Mathematics.....	452
16.6.3	Reference Waveforms.....	456
16.6.4	Search.....	460
16.6.5	History (Option R&S RTM-K15).....	476
	16.7 Measurements.....	488
16.7.1	Quick Measurements.....	488
16.7.2	Automatic Measurements.....	489
16.7.3	Cursor Measurements.....	500
	16.8 Applications.....	507
16.8.1	General.....	507
16.8.2	Mask Testing.....	507
16.8.3	FFT Analysis.....	512
16.8.4	Spectrum Analysis (Option R&S RTM-K18).....	519
16.8.5	XY-Waveforms.....	527
16.8.6	Digital Voltmeter.....	528
16.8.7	Trigger Counter.....	530
16.8.8	Bode Plot (Option R&S RTM-K36).....	531
	16.9 Documenting Results.....	539
16.9.1	Transfer of Waveform Data.....	539
16.9.2	Waveform Data Export to File.....	551
16.9.3	Screenshots.....	552
16.9.4	Instrument Settings: Mass MEMemory Subsystem.....	554
	16.10 General Instrument Setup.....	560
16.10.1	Display Settings.....	561

16.10.2	System Settings.....	565
16.10.3	LAN Settings.....	569
16.10.4	USB Settings.....	571
16.10.5	Trigger Out.....	572
16.10.6	Firmware Update.....	572
16.11	Serial Bus Analysis.....	574
16.11.1	General.....	574
16.11.2	SPI (Option R&S RTM-K1).....	576
16.11.3	I ² C.....	589
16.11.4	UART (Option R&S RTM-K2).....	599
16.11.5	CAN (Option R&S RTM-K3).....	608
16.11.6	LIN (Option R&S RTM-K3).....	624
16.11.7	Audio (Option R&S RTM-K5).....	637
16.11.8	MIL-1553 (Option R&S RTM-K6).....	649
16.11.9	ARINC 429 (Option R&S RTM-K7).....	671
16.12	Power Analysis (Option R&S RTM-K31).....	684
16.12.1	General.....	684
16.12.2	Probe Adjustment.....	686
16.12.3	Report.....	687
16.12.4	Consumption.....	688
16.12.5	Dynamic ON Resistance.....	690
16.12.6	Power Efficiency.....	691
16.12.7	Current Harmonic.....	693
16.12.8	Inrush Current.....	699
16.12.9	Modulation Analysis.....	700
16.12.10	Turn On/Off.....	704
16.12.11	Quality.....	705
16.12.12	Ripple.....	709
16.12.13	Slew Rate.....	714
16.12.14	S.O.A.....	720
16.12.15	Spectrum.....	728
16.12.16	Switching.....	731
16.12.17	Transient Response.....	735

16.13	Mixed Signal Option (Option R&S RTM-B1)	737
16.13.1	Logic Channels.....	737
16.13.2	Parallel Buses.....	744
16.14	Signal Generation (Option R&S RTM-B6)	748
16.14.1	Function Generator.....	748
16.14.2	Pattern Generator.....	756
16.15	Status Reporting	764
16.15.1	STATus:OPERation Register.....	764
16.15.2	STATus:QUEStionable Registers.....	765
17	Maintenance	770
17.1	Cleaning	770
17.2	Storing and Packing	770
17.3	Replacing the Fuse	771
17.4	Data Security	771
Annex	772	
A	Remote Control - Basics	772
A.1	SCPI Command Structure	772
A.1.1	Syntax for Common Commands.....	772
A.1.2	Syntax for Device-Specific Commands.....	773
A.1.3	SCPI Parameters.....	774
A.1.4	Overview of Syntax Elements.....	777
A.1.5	Structure of a Command Line.....	778
A.1.6	Responses to Queries.....	779
A.2	Command Sequence and Synchronization	780
A.2.1	Preventing Overlapping Execution.....	780
A.3	Messages	782
A.3.1	Instrument Messages.....	782
A.3.2	LAN Interface Messages.....	783
B	Remote Control - Status Reporting System	784
B.1	Structure of a SCPI Status Register	784
B.2	Hierarchy of status registers	785
B.3	Contents of the Status Registers	787

B.3.1	Status Byte (STB) and Service Request Enable Register (SRE).....	787
B.3.2	Event Status Register (ESR) and Event Status Enable Register (ESE).....	788
B.3.3	STATus:OPERation Register.....	789
B.3.4	STATus:QUESTionable Register.....	789
B.4	Application of the Status Reporting System.....	793
B.4.1	Service Request.....	793
B.4.2	Serial Poll.....	793
B.4.3	Query of an instrument status.....	794
B.4.4	Error Queue.....	794
B.5	Reset Values of the Status Reporting System.....	795
	List of Commands.....	796

1 Preface

1.1 Safety Information

The R&S RTM3000 oscilloscope is designed for measurements on circuits that are only indirectly connected to the mains or not connected at all. It is not rated for any measurement category.

The instrument is rated for pollution degree 2 - for indoor, dry location use where only non-conductive pollution occurs. Temporary conductivity caused by condensation is possible.

The instrument is intended for use in industrial areas. When used in residential areas, radio disturbances caused by the instrument can exceed given limits. Additional shielding can be required.

The instrument must be controlled by personnel familiar with the potential risks of measuring electrical quantities. Observe applicable local or national safety regulations and rules for the prevention of accidents.

Safety information is part of the product documentation. It warns you about the potential dangers and gives instructions how to prevent personal injury or damage caused by dangerous situations. Safety information is provided as follows:

- The "Basic Safety Instructions" in different languages are delivered as a printed brochure with the instrument.
- Throughout the documentation, safety instructions are provided when you need to take care during setup or operation.

WARNING

Risk of injury

Use the instrument in an appropriate manner to prevent electric shock, personal injury, or fire:

- Do not open the instrument casing.
 - Do not use the instrument if you detect or suspect any damage of the instrument or accessories.
 - Do not operate the instrument in wet, damp or explosive atmospheres.
 - Make sure that the instrument is properly grounded.
 - Do not use the instrument to ascertain volt-free state.
 - Do not exceed the voltage limits given in [Chapter 2.2.1.1, "Input Connectors"](#), on page 25.
-

NOTICE**Risk of instrument damage due to inappropriate operating conditions**

An unsuitable operating site or test setup can damage the instrument and connected devices. Before switching on the instrument, observe the information on appropriate operating conditions provided in the data sheet. In particular, ensure the following:

- All fan openings are unobstructed and the airflow perforations are unimpeded. A minimum distance of 10 cm to other objects is recommended.
- The instrument is dry and shows no sign of condensation.
- The instrument is positioned as described in the following sections.
- The ambient temperature does not exceed the range specified in the data sheet.
- Signal levels at the input connectors are all within the specified ranges.
- Signal outputs are connected correctly and are not overloaded.

Electromagnetic interference (EMI) may affect the measurement results.

To suppress generated electromagnetic interference (EMI):

- Use suitable shielded cables of high quality. For example, use double-shielded RF and LAN cables.
- Always terminate open cable ends.
- Note the EMC classification in the data sheet.

1.2 Documentation Overview

This section provides an overview of the R&S RTM3000 user documentation.

1.2.1 Manuals and Instrument Help

You find the manuals on the product page at:

www.rohde-schwarz.com/manual/rtm3000

Getting started manual

Introduces the R&S RTM3000 and describes how to set up the product. A printed English version is included in the delivery.

User manual

Contains the description of all instrument modes and functions. It also provides an introduction to remote control, a complete description of the remote control commands with programming examples, and information on maintenance and instrument interfaces. Includes the contents of the getting started manual.

The *online version* of the user manual provides the complete contents for immediate display on the internet.

Instrument help

The help offers quick, context-sensitive access to the functional description directly on the instrument.

Basic safety instructions

Contains safety instructions, operating conditions and further important information. The printed document is delivered with the instrument.

Instrument security procedures manual

Deals with security issues when working with the R&S RTM3000 in secure areas.

Service manual

Describes the performance test for checking the rated specifications, module replacement and repair, firmware update, troubleshooting and fault elimination, and contains mechanical drawings and spare part lists. The service manual is available for registered users on the global Rohde & Schwarz information system (GLORIS, <https://gloris.rohde-schwarz.com>).

1.2.2 Data Sheet and Brochure

The data sheet contains the technical specifications of the R&S RTM3000. It also lists the options with their order numbers and optional accessories. The brochure provides an overview of the instrument and deals with the specific characteristics.

See www.rohde-schwarz.com/brochure-datasheet/rtm3000

1.2.3 Calibration Certificate

The document is available on <https://gloris.rohde-schwarz.com/calcert>. You need the device ID of your instrument, which you can find on a label on the rear panel.

1.2.4 Release Notes and Open Source Acknowledgment

The release notes list new features, improvements and known issues of the current firmware version, and describe the firmware installation. The open source acknowledgment document provides verbatim license texts of the used open source software.

See www.rohde-schwarz.com/firmware/rtm3000. The open source acknowledgment document can also be read directly on the instrument.

1.3 Conventions Used in the Documentation

1.3.1 Typographical Conventions

The following text markers are used throughout this documentation:

Convention	Description
"Graphical user interface elements"	All names of graphical user interface elements on the screen, such as dialog boxes, menus, options, buttons, and softkeys are enclosed by quotation marks.
[Keys]	Key and knob names are enclosed by square brackets.
Filenames, commands, program code	Filenames, commands, coding samples and screen output are distinguished by their font.
<i>Input</i>	Input to be entered by the user is displayed in italics.
Links	Links that you can click are displayed in blue font.
"References"	References to other parts of the documentation are enclosed by quotation marks.

1.3.2 Conventions for Procedure Descriptions

When operating the instrument, several alternative methods may be available to perform the same task. In this case, the procedure using the touchscreen is described. Any elements that can be activated by touching can also be clicked using an additionally connected mouse. The alternative procedure using the keys on the instrument or the on-screen keyboard is only described if it deviates from the standard operating procedures.

The term "select" may refer to any of the described methods, i.e. using a finger on the touchscreen, a mouse pointer in the display, or a key on the instrument or on a keyboard.

1.3.3 Notes on Screenshots

When describing the functions of the product, we use sample screenshots. These screenshots are meant to illustrate as many as possible of the provided functions and possible interdependencies between parameters. The shown values may not represent realistic usage scenarios.

The screenshots usually show a fully equipped product, that is: with all options installed. Thus, some functions shown in the screenshots may not be available in your particular product configuration.

2 Getting Started

2.1 Preparing for Use

2.1.1 Unpacking and Checking the Instrument

1. Inspect the package for damage.
If the packaging material shows any signs of stress, notify the carrier who delivered the instrument.
2. Carefully unpack the instrument and the accessories.
3. Check the equipment for completeness. See section "[Delivery contents](#)" on page 21.
4. Check the equipment for damage.
If there is damage, or anything is missing, immediately contact the carrier as well as your distributor. Make sure not to discard the box and packing material.



Packing material

Retain the original packing material. If the instrument needs to be transported or shipped later, you can use the material to protect the control elements and connectors.

Delivery contents

The delivery package contains the following items:

- R&S RTM3000 oscilloscope
- R&S RT-ZP05 probes (2x for R&S RTM3002; 4x for R&S RTM3004)
- Country-specific power cable
- Printed "Getting Started" manual
- Printed "Basic Safety Instructions" brochure

2.1.2 Positioning the Instrument

The instrument is designed for use under laboratory conditions. It can be used in standalone operation on a bench top or can be installed in a rack.

For standalone operation, place the instrument on a horizontal bench with even, flat surface. The instrument can be used in horizontal position, or with the support feet on the bottom extended.

The instrument can be installed in a 19" rack mount using a rack mount kit. The order number of the rack mount kit is given in the data sheet. The installation instructions are part of the rack mount kit.

⚠ CAUTION

Risk of injury if feet are folded out

The feet can fold in if they are not folded out completely or if the instrument is shifted. This can cause damage or injury.

- Fold the feet completely in or out to ensure stability of the instrument. Never shift the instrument when the feet are folded out.
- When the feet are folded out, do not work under the instrument or place anything underneath.
- The feet can break if they are overloaded. The overall load on the folded-out feet must not exceed 200 N.

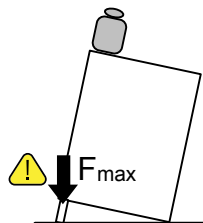

NOTICE

Risk of instrument damage due to overheating

An insufficient airflow can cause the R&S RTM3000 to overheat, which can impair the measurement results, disturb the operation, and even cause damage.

- Ensure that all fan openings are unobstructed and that the airflow perforations are unimpeded. The minimum distance to a wall is 10 cm.
- When placing several instruments side by side, keep a minimum distance of 20 cm between the instruments. Ensure that the instruments do not draw in the preheated air from their neighbors.
- When mounting the instrument in a rack, observe the instructions of the rack manufacturer to ensure sufficient airflow and avoid overheating.

2.1.3 Starting the Instrument

The R&S RTM3000 can be used with different AC power voltages and adapts itself automatically to it.

The nominal ranges are:

- 100 V to 240 V AC at 50 Hz to 60 Hz
- 1.6 A to 0.7 A

- max. 160 W

CAUTION

Risk of injury

Connect the instrument only to an outlet that has a ground contact.

Do not use an isolating transformer to connect the instrument to the AC power supply.

To start the instrument

1. Connect the power cable to the AC power connector on the rear panel of the R&S RTM3000.
2. Connect the power cable to the socket outlet.
3. Switch the main power switch at the rear of the instrument to position I.
The [Standby] key lights up. The key is located in the bottom left corner of the front panel.
4. Press the [Standby] key.
The instrument performs a system check and starts the firmware.



Warm-up and prepare the instrument

Make sure that the instrument has been running and warming up before you start the self-alignment and the measurements. The minimum warm-up time is about 30 min.

To power off the instrument

1. Press the [Standby] key.
All current settings are saved, and the software shuts down. All data transfers and running processes are interrupted.
2. Switch the main power switch at the rear of the instrument to position 0.
3. Disconnect the AC power cable from the AC power supply.

Overview of power switch and [Standby] key actions

Action	Condition	Result	[Standby]
Set power switch to I.	[Standby] key was <i>off</i> when switching power switch to 0.	Instrument is in standby mode.	Yellow
	[Standby] key was <i>on</i> when switching power switch to 0.	Instrument performs system check and boots the firmware. It is ready for operation.	Green
Switch [Standby] on.	Power switch is on.		

Action	Condition	Result	[Standby]
Switch [Standby] off.	Power switch is on.	Software shuts down. All instrument settings are saved, running data transfers and processes are interrupted (e.g., self-alignment). Instrument is in standby mode.	Yellow
Set power switch to 0.	Instrument is working, [Standby] is Green.	Software shuts down. All instrument settings are saved, running data transfers and processes are interrupted (e.g., self-alignment). No power on the instrument.	Off
Set power switch to 0.	Instrument is in standby mode, [Standby] is Yellow.	No power on the instrument.	Off

2.1.4 Replacing the Fuse

The instrument is protected by a fuse. You can find it on the rear panel between the main power switch and AC power supply.

Type of fuse: Size 5x20 mm, 250V~, T3.15H (slow-blow), IEC60127-2/5

WARNING

Risk of electric shock

The fuse is part of the main power supply. Therefore, handling the fuse while power is on can lead to electric shock. Before opening the fuse holder, make sure that the instrument is switched off and disconnected from all power supplies.

Always use fuses supplied by Rohde & Schwarz as spare parts, or fuses of the same type and rating.

1. Pull the fuse holder out of its slot on the rear panel.
2. Exchange the fuse.
3. Insert the fuse holder carefully back in its slot until it latches.

2.2 Instrument Tour

2.2.1 Front View

[Figure 2-1](#) shows the front panel of the R&S RTM3000. The function keys are grouped in functional blocks to the right of the display.

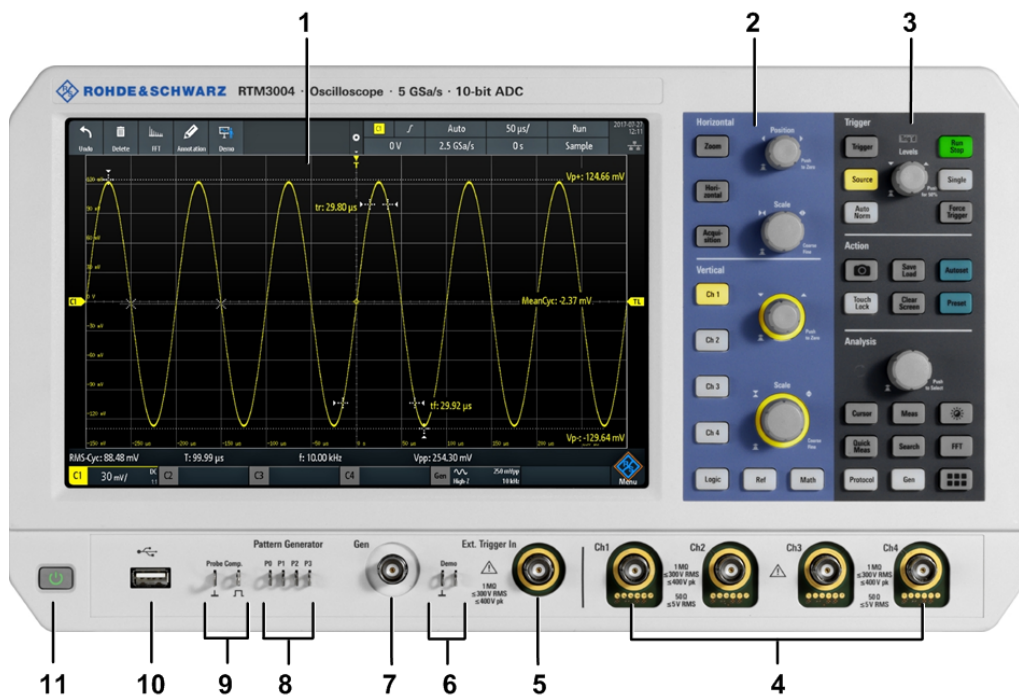
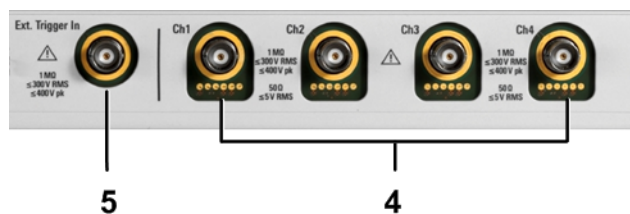

Figure 2-1: Front panel of R&S RTM3000 with 4 input channels

- 1 = Display
- 2 = Horizontal and vertical setup controls
- 3 = Trigger settings, action and analysis controls
- 4 = Analog input channels (BNC)
- 5 = External trigger input
- 6 = Connectors for demo signal output
- 7 = Connector for optional function generator output (BNC, R&S RTM-B6)
- 8 = Connectors for optional pattern generator (R&S RTM-B6)
- 9 = Connectors for probe compensation
- 10 = USB connector
- 11 = [Standby] key

The R&S RTM3002 has 2 input channels, and the R&S RTM3004 has 4 input channels.

2.2.1.1 Input Connectors



BNC inputs (4 and 5)

The R&S RTM3000 has two or four channel inputs (4) to connect the input signals. The external trigger input (5) is used to control the measurement by an external signal. The trigger level can be set from -5 V to 5 V.

For channel connectors, the input impedance is selectable, the values are 50 Ω and 1 M Ω .

WARNING

Risk of electrical shock - maximum input voltages

The maximum input voltage on *channel inputs* must not exceed:

- 400 V (peak) and 300 V (RMS) at 1 M Ω input impedance
- 30 V (peak) and 5 V (RMS) at 50 Ω input impedance

For the *external trigger input*, the maximum input voltage is 400 V (peak) and 300 V (RMS) at 1 M Ω input impedance.

Transient overvoltages must not exceed 400 V (peak).

For further specifications, refer to the data sheet.

Voltages higher than 30 V (RMS) or 42 V (peak) or 60 V DC are regarded as hazardous contact voltages. When working with hazardous contact voltages, use appropriate protective measures to preclude direct contact with the measurement setup:

- Use only insulated voltage probes, test leads and adapters.
- Do not touch voltages higher than 30 V (RMS) or 42 V (peak) or 60 V DC.

CAUTION

Risk of injury and instrument damage

The instrument is not rated for any measurement category. When measuring in circuits with transient overvoltages of category II, III or IV circuits, make sure that no such overvoltages reach the R&S RTM3000 input. Therefore, use only probes that comply with DIN EN 61010-031. When measuring in category II, III or IV circuits, always insert a probe that appropriately reduces the voltage so that no transient overvoltages higher than 400 V (peak) are applied to the instrument. For detailed information, refer to the documentation and safety information of the probe manufacturer.

Explanation: According to section AA.2.4 of EN 61010-2-030, measuring circuits without any measurement category are intended for measurements on circuits which are not directly connected to the mains.

2.2.1.2 Other Connectors on the Front Panel

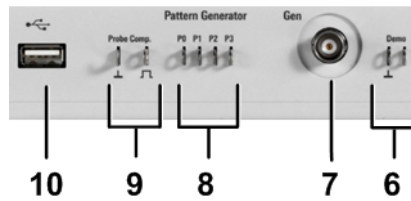

[Demo] (6)

The pins are intended for demonstration purposes.

[Gen]: Function Generator (7)



BNC output of the function generator (with option R&S RTM-B6).

[Pattern Generator] (8)

Connectors for the pattern generator P0, P1, P2, P3.

[Probe Comp.] (9)

Probe compensation terminal to support adjustment of passive probes to the oscilloscope channel.

-  Square wave signal for probe compensation.
-  Ground connector for probes.

[USB] type A (10)

USB 2.0 type A interface to connect a mouse or a keyboard, or a USB flash drive for storing and reloading instrument settings and measurement data, and to update the firmware.

2.2.2 Side View

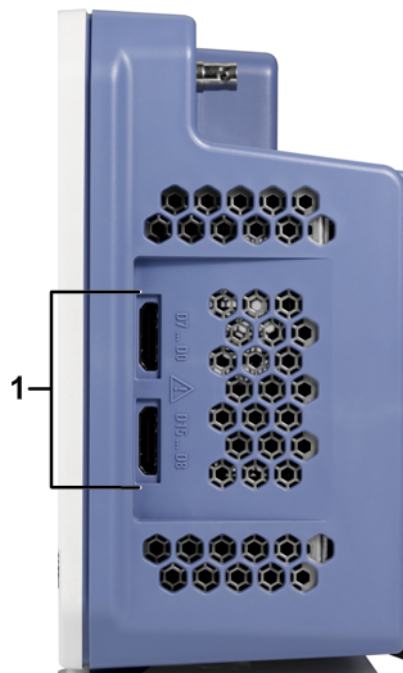

Figure 2-2: Side view of R&S RTM3000

1 = Connectors for logic probe (Mixed Signal Option R&S RTM-B1)

Logic probe

The connectors for logic channels can be used if the Mixed Signal Option R&S RTM-B1 is installed. The option provides connectors for two logical probes with 8 digital channels each (D0 to D7 and D8 to D15).

The maximum input voltage is 40 V (peak) at 100 k Ω input impedance. The maximum input frequency for a signal with the minimum input voltage swing and medium hysteresis of 800 mV (V_{pp}) is 400 MHz.

2.2.3 Rear View

[Figure 2-3](#) shows the rear panel of the R&S RTM3000 with its connectors.

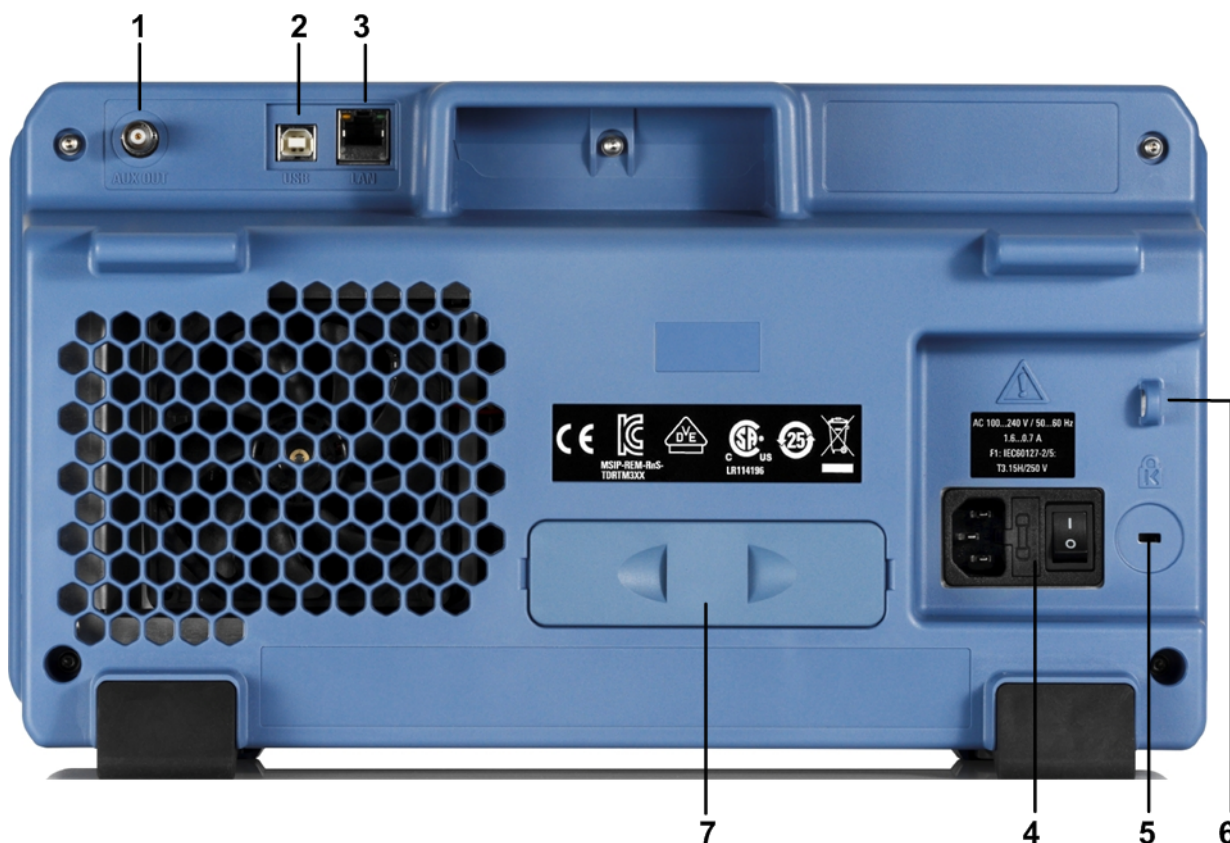

Figure 2-3: Rear panel view of R&S RTM3000

- 1 = Aux Out connector
- 2 = USB connector, type B
- 3 = LAN connector
- 4 = AC power supply connector and main power switch
- 5 = Kensington lock slot to secure the instrument against theft
- 6 = Loop for lock to secure the instrument against theft
- 7 = not used

[Aux Out] (1)

Multi-purpose BNC output that can function as pass/fail and trigger output, and output of 10 MHz reference frequency.

[USB] type B (2)

USB 2.0 interface of type B (device USB) for remote control of the instrument.

Note: Electromagnetic interference (EMI) can affect the measurement results. To avoid any impact, use only USB connecting cables with a maximum length of 1 m.

[LAN] (3)

8-pin connector RJ-45 used to connect the instrument to a Local Area Network (LAN). It supports up to 1 Gbit/s.

AC supply: mains connector and main power switch (4)

The instrument supports a wide range power supply. It automatically adjusts to the correct range for the applied voltage. There is no line voltage selector.

The AC main power switch disconnects the instrument from the AC power line.

3 Operating Basics

3.1 Display Overview

The touchscreen display of the instrument shows the waveforms and measurement results, and also information and everything that you need to control the instrument.

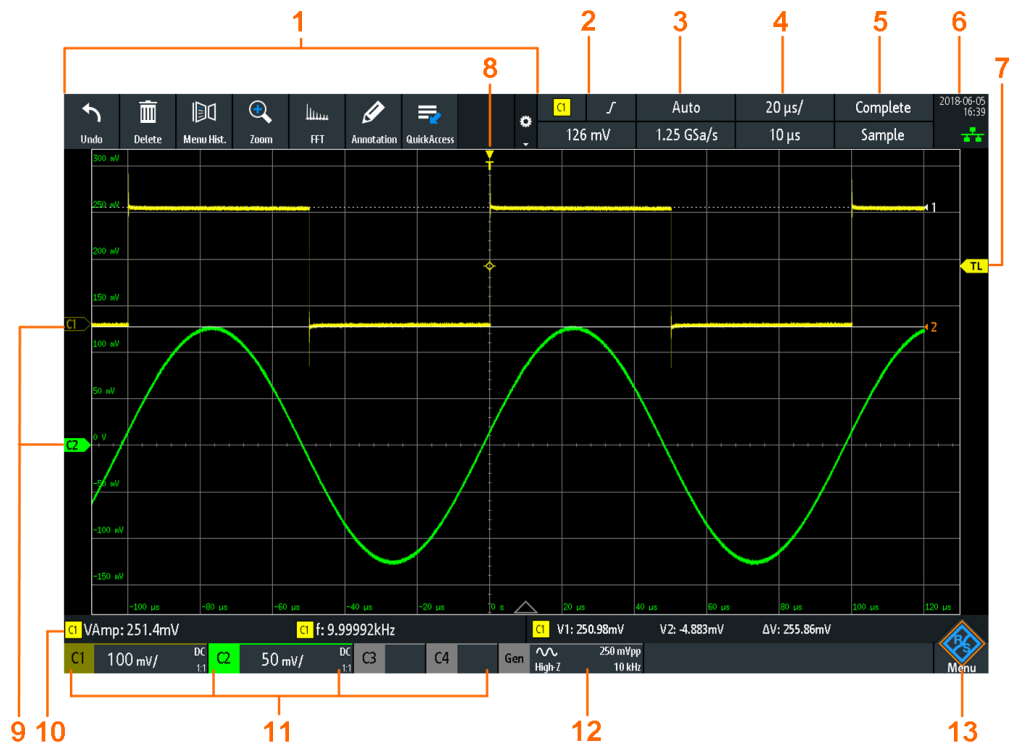



Figure 3-1: Display of the R&S RTM3000 with 4 channels

- 1 = Toolbar
- 2 = Trigger source, main trigger parameter (here: slope for edge trigger), trigger level
- 3 = Trigger mode and sample rate
- 4 = Horizontal scale (time scale) and horizontal position
- 5 = Acquisition status and acquisition mode
- 6 = Date, time, education mode if active (here: off), LAN connection status (green = connected, grey = not connected, yellow = connecting)
- 7 = Trigger level marker, has the color of the trigger source
- 8 = Trigger position marker, has the color of the trigger source
- 9 = Channel markers indicate the ground levels; channel C2S is selected, i.e. it has the focus
- 10 = Measurement results (here: automatic measurements on the left, cursor measurements on the right)
- 11 = Vertical settings of active analog channels: vertical scale, bandwidth limitation (no indicator = full bandwidth, B_W = limited frequency), coupling (AC, DC, ground), probe attenuation. Channel 2 is selected.
- 12 = Waveform generator settings (requires option R&S RTM-B6)
- 13 = Menu button

3.2 Selecting the Application

The "Apps Selection" dialog provides fast access to all available applications.

- ▶ There are several ways to open the "Apps Selection" dialog:
 - Press the  [Apps Selection] key.
 - Tap the "Menu" rhomb icon in the lower right corner of the screen.



- Scroll down.
- Select "Apps".

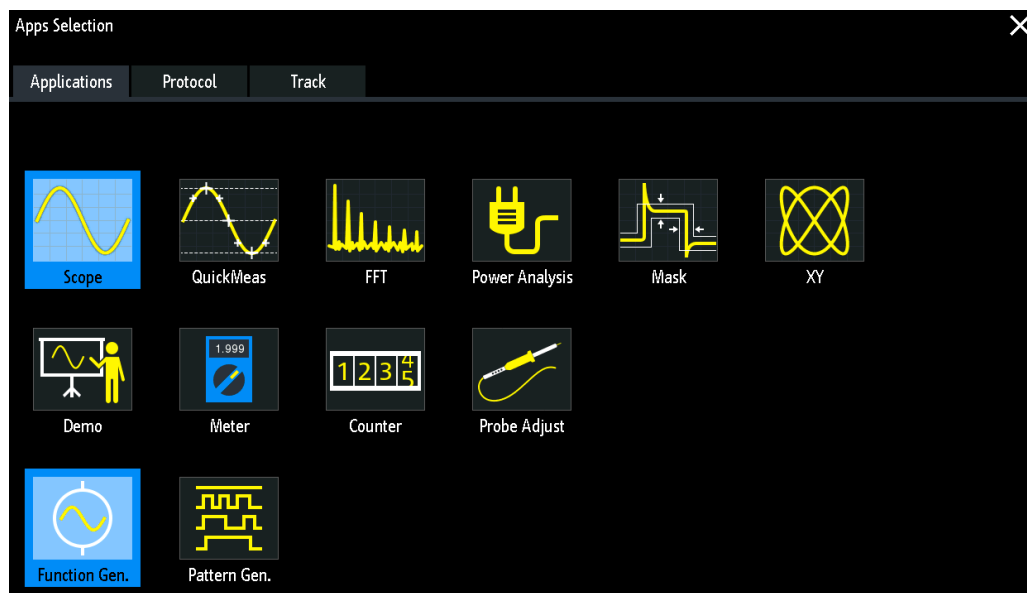

3.3 Using the Touchscreen

3.3.1 Accessing Functionality Using the Main Menu

Using the touchscreen of the R&S RTM3000 is as easy as using your mobile phone. To open the main menu, tap the "Menu" button - that is the R&S logo in the right bottom corner of the display.

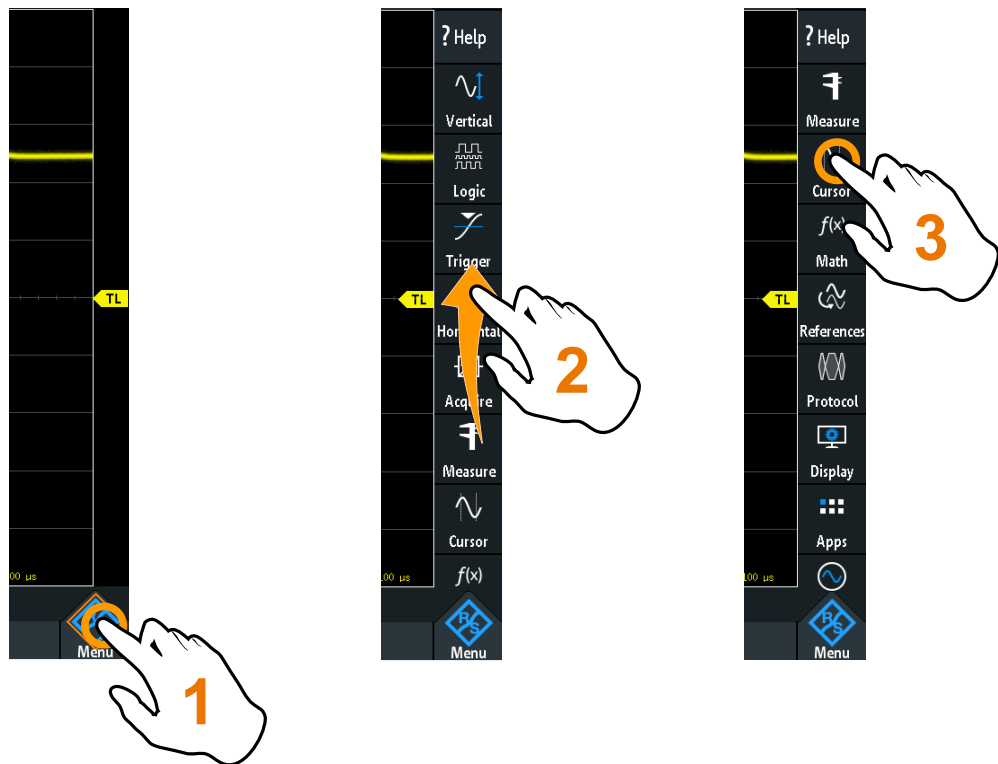

Figure 3-2: Open the main menu and select a menu item

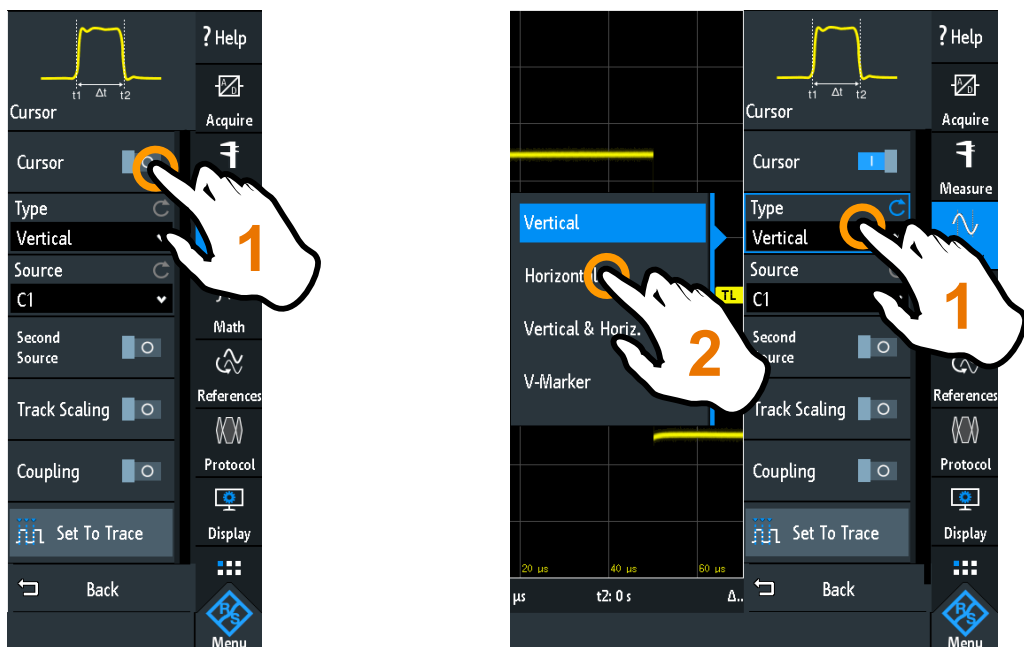

Figure 3-3: Switch on or off (left) and select a parameter value (right)

► To close the menu:

Tap "Back", or tap into the diagram outside the menu.

3.3.2 Accessing Functionality Using Shortcuts

The labels in information bar at the top of the display, the channel labels and also the results at the bottom provide shortcuts to the most important settings. If you tap a label, a short menu opens, the keypad for numerical entry, the setting toggles, or the corresponding menu opens. The response depends on the selected parameter.



Figure 3-4: Short menus for channel (left) and trigger slope (right)



From the short menu, you can also open the corresponding comprehensive menu. You can also switch off the channels.

3.3.3 Entering Data

To enter exact numerical values, the instrument provides an on-screen keypad. For text input, the on-screen keyboard works in the same way.



Figure 3-5: Enter numerical value and unit

3.3.4 Using Gestures

Drag one finger



Drag *horizontally* in the diagram to change the horizontal position of all waveforms. In frequency domain, the center frequency is changed.



Drag *vertically* in the diagram to change the vertical position of the selected waveform.

To adjust the vertical position of each waveform, the trigger level, and the trigger position, drag the corresponding marker on the display.

To drag a cursor line, tap the line and drag it to the required position.



Swipe one finger

Swipe in the menu to scroll it.

Spread and pinch two fingers



Spread or pinch two fingers in *vertical* direction to change the vertical scale of the selected waveform.

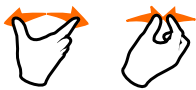

Spread or pinch two fingers in *horizontal* direction to change the horizontal scale of all waveforms. In frequency domain, the frequency span is changed.

Swipe two fingers



If the history option R&S RTM-K15 is installed, swipe two fingers in the diagram to scrolls through the history segments.

3.4 Front Panel Keys

For an overview of the front panel keys, see [figure 2-1 on page 25](#).

The keys and knobs at the front panel are grouped in functional blocks:

- Horizontal section: see [Chapter 4.4.1, "HORIZONTAL Controls"](#), on page 63.
- Vertical section: see [Chapter 4.3.1, "VERTICAL Controls"](#), on page 45.
- Trigger section: see [Chapter 5.1, "Trigger Controls"](#), on page 72
- Action section, see [Chapter 3.4.1, "Action Controls"](#), on page 36.
- Analysis section, see [Chapter 3.4.2, "Analysis Controls"](#), on page 37.

3.4.1 Action Controls

The Action keys set the instrument to a defined state, and provide save and load functions.

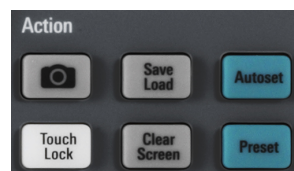

[Camera]

Saves screenshots, waveforms and/or settings according to the configuration in [Save Load] > "onetouch".

[Save Load]

Opens the "File" menu, where you can:

- Save instrument settings, waveforms, reference waveforms, and screenshots
- Restore (load) data which were saved before
- Import and export settings and reference waveforms
- Configure the screenshot output
- Configure the behavior of the [Camera] key

[Touch Lock]

Locks the touchscreen to prevent unintended use. When the touchscreen is off, the key is illuminated. Press again to unlock the touchscreen.

[Clear Screen]

Deletes all waveforms, annotations and the measurement results of deleted waveforms. All settings remain unchanged.

Remote command:

[DISPlay:CLEAr\[:SCReen\]](#) on page 561

3.4.2 Analysis Controls

The controls in the [Analysis] functional block open various menus for signal analysis.

**[Navigation]**

The function of this universal rotary knob depends on the usage context:

- If selection menu is open: turn the knob to select a value.
- If a numerical value is selected in the menu, and the keypad is closed: turn the knob to set a value.
- If the cursors are selected, press the key to select a cursor line. Turn the knob to change the position of the selected cursor line.
- If an on-screen keypad or on-screen keyboard is open: turn the knob until the required character is highlighted, then press the knob to apply the selection.
- Otherwise: turn the knob to set the waveform intensity, or press the knob to set the intensity to 50%.

[Cursor]

Enables the cursor with the last configured cursor setup. The second keypress opens the "Cursor" menu. If the menu is open, pressing the key turns off the cursor and closes the menu.

[Meas]

Opens the "Measure" menu, where you can configure up to 8 parallel measurements. Available measurement types depend on the type of the selected waveform.

[Intensity]

Opens the "Intensities" menu to adjust the luminosity of display elements and the persistence.

[QuickMeas]

Displays the results of basic automatic measurements for the selected channel below the grid and directly on the waveform.

Press the key to stop quick measurements.

Note: Channels other than the selected one are switched off in quick measurement mode. When you activate quick measurements, cursor measurements are automatically deactivated. Deactivate quick measurements before selecting the cursors.

[Search]

Enables the search with the last configured setup. The second keypress opens the "Search" menu, where you can perform a search for various events in an acquisition - for example, peaks or specific width conditions - and analyze the search results.

[FFT]

Activates the spectrum analysis functions with the last configured setup. The second keypress opens the "FFT" menu.

To deactivate spectrum analysis, press the [FFT] key until the time domain waveform is displayed.

[Protocol]

Opens the "Bus" menu, which contains the configuration of serial and parallel buses and the settings for decoding the signals. Key function requires at least the MSO option R&S RTM-B1 or one of the serial protocol options. See data sheet for available options.

[Gen]

Opens the "Function Generator" menu, where you can create various waveforms. Key function requires option R&S RTM-B6.

[Apps Selection]

Opens the "Apps Selection" dialog where you can select the required application or protocol for your task, for example, mask testing or CAN protocol.

3.5 Using the Toolbar

The toolbar at the top of the display provides direct access to important control and measurement functions. The selected function is highlighted. By default, the toolbar shows the most frequently used functions. You can configure the content of the toolbar so that only the required functions are displayed..

Some of the toolbar functions are one-click actions. These actions are performed immediately when you tap the icon. Other toolbar functions are interactive actions. When you tap an interactive action, a message informs you what to do next.

Configuring the Toolbar

1. Tap the "Toolbar Setup" icon.



2. Disable the functions that you do not need.
3. Tap the functions that you need. You can select maximum 8 functions.

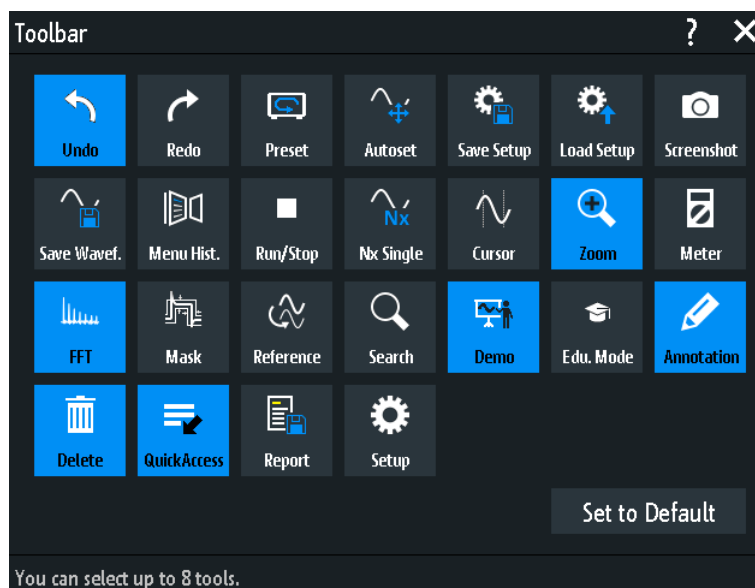

4. Close the dialog box.

3.6 Quick Access

If the measurement task requires to change the settings from different menus repeatedly, you can use the "QuickAccess". The "QuickAccess" is a user-defined menu, which can be added to the toolbar.

To configure the "QuickAccess" menu:

1. Add the "QuickAccess" icon to the toolbar as described in ["Configuring the Toolbar"](#) on page 38.
2. Add the required settings and functions to the "QuickAccess" menu:
 - a) Open the menu that contains the setting.
 - b) Drag the setting from the menu and drop it on the diagram.
The setting is added to the "QuickAccess".

- c) Repeat steps a) and b) for each setting and function that you need for the measurement task.

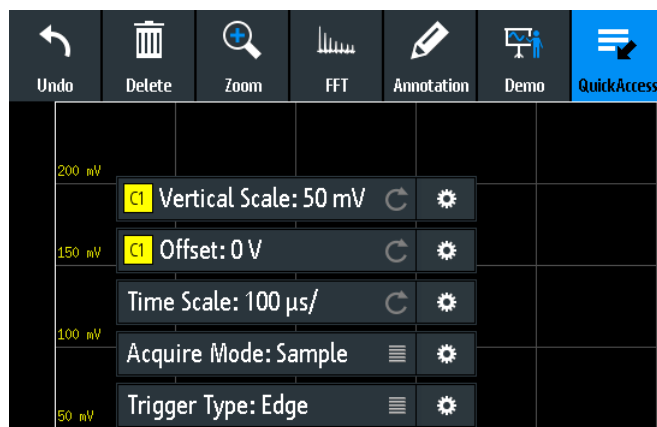

3. To remove unwanted settings and functions:
 - a) Tap the "Settings" icon of the function.
 - b) To delete the selected setting or function, tap "Delete".
 - c) To delete the complete "QuickAccess" menu, tap "Delete All".
- To show or hide the "QuickAccess" menu, tap the "QuickAccess" icon on the toolbar.

3.7 Menu History

The menu history is another way to speed up and simplify the usage of the R&S RTM3000. The menu history is also a user-defined menu, which can be added to the toolbar. It logs all menus that you used during the current session.

1. Add the "Menu Hist." icon to the toolbar as described in ["Configuring the Toolbar"](#) on page 38.
2. Open some menus and set up parameters.
3. Tap the "Menu Hist." icon on the toolbar.
4. Tap the menu that you want to open.

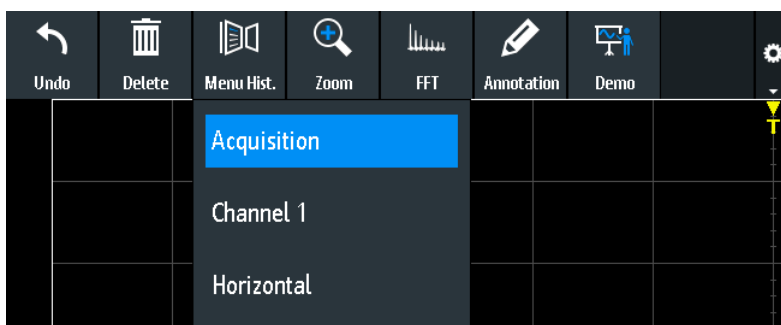

3.8 Getting Help

In most menus and dialogs, graphics explain the meaning of the selected setting. For further information, you can open the help, which provides functional description of selected setting.

To open the help window

1. Tap the "Menu" icon in the lower right corner of the screen.
2. Tap "Help" on the top of the main menu.
3. Tap the setting for which you need information.

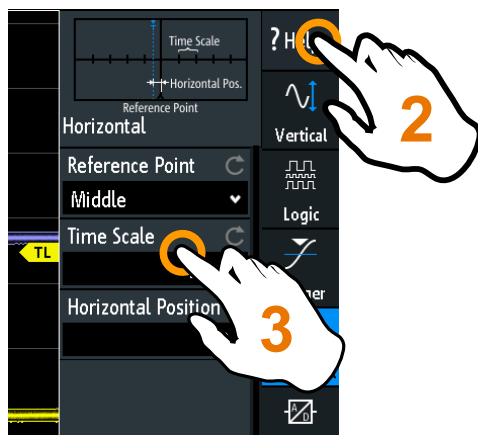

To close the help window

- ▶ Tap "Help" on the top of the main menu, or tap the "Close" icon in the upper right corner of the help window.

4 Waveform Setup

This chapter describes how to connect and set up probes, to adjust the horizontal and vertical settings, and to control the acquisition.

4.1 Connecting Probes and Displaying a Signal

NOTICE

Risk of instrument damage

Make sure to set the attenuation factor on the instrument according to the probe being used. Otherwise, the measurement results do not reflect the actual voltage level, and you might misjudge the actual risk.

The attenuation of the probes that are delivered with the instrument, and the default attenuation factor of the instrument are 10:1. If you use only the delivered probes and did not change the attenuation factor, no attenuation adjustment is required.

1. Connect the probes first to the channel inputs, and then to the DUT.
2. Tap the label of the used channel in the bottom line of the display.

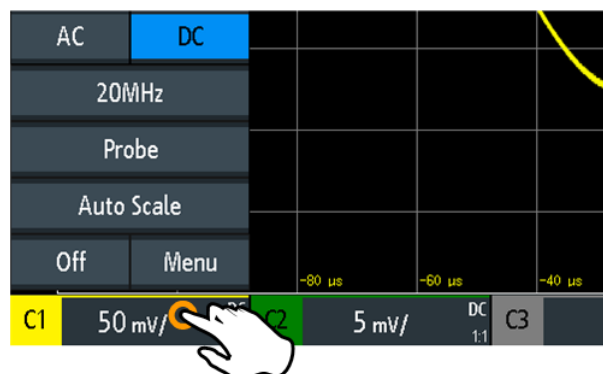

3. Tap "Probe".
4. Select the attenuation factor of the probe.
The probe's attenuation factor is indicated on the probe.
Note: If you measure current using a shunt resistor as a current sensor, you have to multiply the V/A-value of the resistor by the attenuation of the probe. For example, if a 1 Ω resistor and a 10:1 probe is used, the V/A-value of the resistor is 1 V/A. The attenuation factor of the probe is 0.1, and the resulting current probe attenuation is 100 mV/A.
5. If you connect several probes, repeat steps 2 to 4 for the remaining channels.
6. Press the [Autoset] key.

[Autoset]

Analyzes the enabled analog channel signals, and adjusts the horizontal, vertical, and trigger settings to display stable waveforms.

In particular, autoset adjusts the following settings:

- Vertical settings of analog channels: vertical scale, offset, and position
- Horizontal settings: time scale (also in Zoom, Quickmeas, FFT, and XY mode), horizontal position of the trigger
- Trigger: set to automatic trigger mode and edge trigger type (except for pattern trigger), trigger source to active existing signal, automatic hysteresis, trigger coupling to DC, switch off HF / noise reject and hold off
- Reference and math waveforms are switched off
- Annotations are deleted
- Menus are closed

Autoset does not switch off analog and vertical channels, and it does not change the instrument mode, cursor, measurement, and waveform generator settings.

To adjust only vertical settings of one channel, use the "Auto Scale" function in the channel short menu, see [Chapter 4.3.2, "Short Menu for Analog Channels"](#), on page 46.

Remote command:

[AUToscale](#) on page 415

[Preset]

Resets the instrument to the scope mode and to default state, without analyzing the signal. The user-defined configuration, measurements and other settings are removed and all channels and waveforms, except for channel 1, are disabled.

Preset does not change the display settings.

See also: [Chapter 10.3, "Reset"](#), on page 214.

Remote command:

[*RST](#) on page 413

4.2 Adjusting Passive Probes

Passive probes, which are delivered with the instrument, are already pre-compensated to the R&S RTM3000 characteristics, and a compensation procedure is not required.

If you use another passive probe, it is necessary to compensate it when it is connected to the instrument the first time. Compensation matches the probe cable capacitance to the oscilloscope input capacitance to assure good amplitude accuracy from DC to upper bandwidth limit frequencies. A poorly compensated probe reduces the performance of the probe-oscilloscope system and introduces measurement errors resulting in distorted waveforms and inaccurate results.

Two connector pins for compensation are located at the front panel. The left pin is on ground level. The next pin supplies a square wave signal for the adjustment.

1. Press the  [Apps Selection] key.

2. Tap "Probe Adjust".
3. Follow the instructions of the wizard. It guides you through the compensation process.
Use the compensation trimmer of the probe to get optimum square wave response. For details, refer to the documentation of your probe.

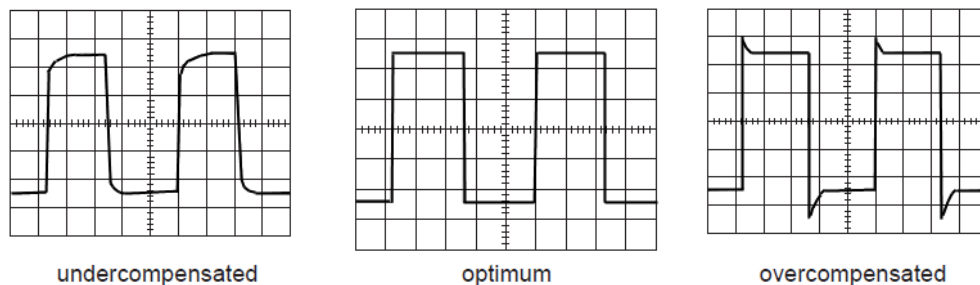

4.3 Vertical Setup

The controls and parameters of the vertical system adjust the vertical scale and position of the waveform, and the waveform display. The probe settings also belong to the vertical setup.

The channel labels at the bottom of the display show the basic vertical settings: vertical scale (for example, channel 3 in the figure below: 500 mV/div), coupling (AC), probe attenuation (10:1), and bandwidth (if limited). Clipping of a waveform is indicated by orange arrows. The label of the selected channel has a brighter colored line on the top.

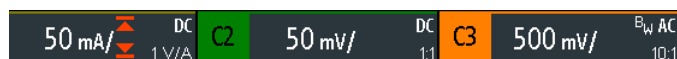

Figure 4-1: Channel labels. Channel 3 is selected. Channel 1 waveform is clipped.

There are several ways to adjust vertical settings:

- Use the controls in the Vertical functional block of the front panel to select the channel, to scale the waveform, and to set the position.
- Drag one finger vertically on the screen to change the position of the selected channel waveform.
- Spread or pinch two fingers in vertical direction to change the vertical scale of the selected waveform.
- Use the short menu to adjust coupling and the probe, and to set the vertical scale automatically.
- Use the comprehensive menu to adjust all vertical settings.

4.3.1 VERTICAL Controls



[Ch <n>]

For each analog channel, a channel key is available. The key is illuminated in the channel color, if the channel is on.

The effect of the keypress depends on state of the channel:

- If channel is off: Turns on the channel and selects it. The rotary knobs alongside light up in the channel color.
- If the channel is on and in focus (selected): Opens the corresponding channel menu.
- If the channel is on but not in focus (not selected): Selects the channel waveform.
- If the channel is selected, and the menu is open: Pressing the key turns off the channel.

Remote command:

[CHANnel<m>:STATe](#) on page 417

[Offset/Position (upper knob)]

The upper vertical knob adjusts the following, depending on the selected waveform:

- Offset or position of an analog channel (adjustable: main menu > "Vertical"). The visual effect is the same. While the offset sets a voltage, position is a graphical setting given in divisions.
- Vertical position of a math or reference waveform, serial bus, or logic pod

The knob lights up in the color of the selected waveform. Turn clockwise to move up the waveform. Pressing the key has the following effects:

- Analog channels, math waveforms, and buses: sets the value to zero.
- Reference waveforms: sets to original position or to 0 divisions.
- FFT and single bits of a pod: set to default value.
- Pods: set to the center of the display.

Remote command:

[CHANnel<m>:POSition](#) on page 418

[CHANnel<m>:OFFSet](#) on page 418

[CALCulate:MATH<m>:POSition](#) on page 455

[REFCurve<m>:VERTical:POSition](#) on page 459

[Scale]

Sets the vertical scale in Volts per division to change the displayed amplitude of the selected waveform. For analog waveforms, the scale value is shown in the waveform label at the bottom. The knob lights up in the color of the selected waveform.

Turn [Scale] clockwise to stretch the waveform. Doing so, the scale value V/div decreases. Press the knob to toggle between fine and coarse adjustment.

To get the maximum resolution of the waveform amplitude, make sure that the waveforms cover most of the screen's height.

Remote command:

[CHANnel<m>:SCALE](#) on page 417

[CALCulate:MATH<m>:SCALE](#) on page 455

[REFCurve<m>:VERTical:SCALE](#) on page 460

[Logic]

Enables the logic channels. The second keypress opens the menu, where you can select and configure digital channels for analysis. If the menu is open, pressing the key disables the logic channels.

Key function requires MSO option R&S RTM-B1.

Logic analyzer functions are described in [Chapter 14, "Logic Analyzer \(Option R&S RTM-B1, MSO\)"](#), on page 372.

[Ref]

Displays the reference waveforms with their last configuration. The second keypress opens the menu, where you can select, create, save and load reference waveforms. If the menu is open, pressing the key disables the reference waveforms.

Reference waveforms are described in [Chapter 6.3, "Reference Waveforms"](#), on page 107.

[Math]

Displays the math waveforms with their last configuration. A math waveform is a waveform that is calculated from the captured data. The second keypress opens the menu, where you can activate and configure math waveforms, and save and load equation sets. If the menu is open, pressing the key disables the math waveforms.

Mathematics is described in [Chapter 6.2, "Mathematics"](#), on page 97.

4.3.2 Short Menu for Analog Channels

To adjust the probe and the coupling, you can use the short menu. Here you can also open the comprehensive menu, and switch off the channel.

- ▶ To open the short menu for a channel, tap the channel label in the bottom line of the display.

If the channel was not selected, tap twice: Once to select the waveform, and next to open the short menu.

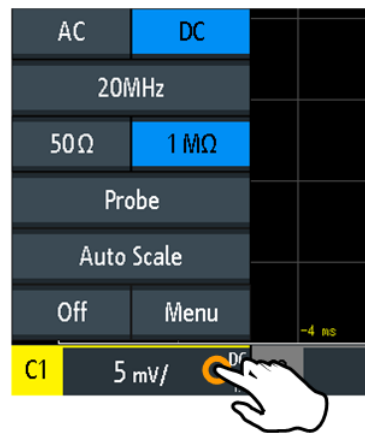

Functions in the short menu:

- "AC | DC": see ["Coupling"](#) on page 49.
- "<current bandwidth>" ("20MHz" in the above example): see ["Bandwidth"](#) on page 49.
- Termination: "1 MΩ" or "50 Ω", see ["Termination"](#) on page 49.
- "Probe": opens the "Probe" menu, see [Chapter 4.3.4, "Probe Settings for Probes with BNC Connector"](#), on page 52.
- "Auto Scale": analyzes the selected channel signal and adjusts the vertical scale. This function is only available in the channel short menu.
- "Off": turns off the channel.
- "Menu": opens the channel menu.

4.3.3 Vertical Settings

The comprehensive "Vertical" menu contains all vertical settings.

1. To open the "Vertical" menu:
 - a) Open the main menu.
 - b) Select "Vertical"
2. Select the parameter that is assigned to the upper vertical knob: "Offset" or "Position".
3. Open the channel menu.

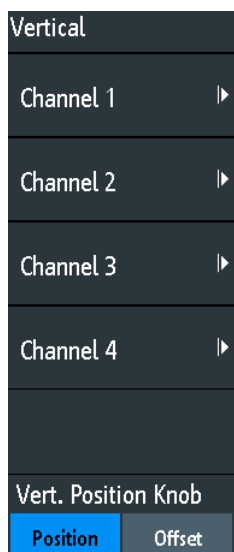

- ▶ To open the channel menu directly, press the corresponding channel key. If the channel was active but not selected, press twice: Once to select the waveform, and next to open the short menu.



Figure 4-2: Channel menu, split into two halves

Vert. Position Knob

Selects the parameter to be changed with the [Offset/Position (upper knob)]: "Offset" or "Position". By default, position is set. [Preset] does not affect the assignment.

Channel <n>

Opens the channel menu.

State

Switches the selected channel on or off.

Remote command:

[CHANnel<m>:STATe](#) on page 417

Coupling

Selects the input coupling, which influences the signal path between input connector and the following internal signal stage. The current coupling of each channel is shown in the waveform labels below the grid.

- "AC" AC coupling is useful if the DC component of a signal is of no interest. AC coupling blocks the DC component of the signal so that the waveform is centered on zero volts.
- "DC" With DC coupling, the input signal passes unchanged, all signal components are shown.

Remote command:

[CHANnel<m>:COUPling](#) on page 418

Termination

Adjusts the input impedance of the instrument to the impedance of the DUT. If an active Rohde & Schwarz probe is used, the termination is read out from the probe - usually it is 50 Ω .

- "1 M Ω " A high input resistor minimizes the loading effect on the device under test. This value is set automatically if a passive probe is connected, and cannot be changed.
- "50 Ω " Used for measurement systems with characteristic impedance of 50 Ω . The input resistor of the oscilloscope minimizes the reflections along the signal path, and increases the accuracy of measurement results. DC coupling is set automatically. 50 Ω termination is indicated in the waveform labels by an Ω .

Remote command:

[CHANnel<m>:COUPling](#) on page 418

Bandwidth

Selects the bandwidth limit. At full bandwidth, all frequencies in the specified range of the instrument are acquired and displayed accurately with less than 3 dB attenuation. Full bandwidth is used for most applications.

To reduce noise, you can set a frequency limit. Higher frequencies are removed from the signal. Limited bandwidth is indicated by "B_w" in the waveform label.

For analog applications, the highest signal frequency determines the required oscilloscope bandwidth. The oscilloscope bandwidth should be at least 3 times higher than the maximum frequency included in the analog test signal to measure the amplitude without aliasing.

Most test signals are more complex than a simple sine wave and include several spectral components. A digital signal, for example, is built up of several odd harmonics. For digital signals, the oscilloscope bandwidth should be at least 5 times higher than the clock frequency to be measured.

The oscilloscope is not an autonomous system. You need a probe to measure the signal, and the probe has a limited bandwidth, too. The combination of oscilloscope and probe creates a system bandwidth. To reduce the effect of the probe on the system bandwidth, the probe bandwidth should exceed the bandwidth of the oscilloscope, the recommended factor is 1.5 x oscilloscope bandwidth.

Remote command:

[CHANnel<m>:BANDwidth](#) on page 419

Vertical Scale

Sets the vertical scale in Volts per division to change the displayed amplitude of the selected waveform. The current value is shown in the waveform label below the grid.

Vertical scale directly affects the resolution of the waveform amplitude. To get the full resolution of the ADC, set up the waveforms to cover most of the height of the diagram.

Remote command:

[CHANnel<m>:SCALE](#) on page 417

Offset

Sets the offset voltage, which corrects an offset-affected signal. The vertical center of the selected channel is shifted by the offset value and the signal is repositioned within the diagram area. To set the offset automatically, use [Autoset].

Use the offset to measure small AC voltages that are overlaid by higher DC voltages. Unlike AC coupling, the DC part of the signal is not lost with offset setting.

If an active probe is connected, the offset limit is defined by the probe. Refer to the documentation of the probe for allowed values.

If an active differential probe is connected, set the common-mode offset to compensate for a common DC voltage applied to both input sockets (referenced to the ground socket). Thus, you can measure on differential signals with high common mode levels, for example, current measurements using a shunt resistor. You can measure the common mode input voltage using the R&S ProbeMeter.

Remote command:

[CHANnel<m>:OFFSet](#) on page 418

Position

Moves the selected signal up or down in the diagram. While the offset sets a voltage, position is a graphical setting given in divisions. The visual effect is the same as for offset.

Remote command:

[CHANnel<m>:POSition](#) on page 418

Ground

Connects the input to a virtual ground. All channel data is set to 0 V. Ground connection is labeled with **⏏**. The coupling is not affected by the ground setting.

Remote command:

[CHANnel<m>:COUPling](#) on page 418

Invert

Turns the inversion of the signal amplitude on or off. To invert means to reflect the voltage values of all signal components against the ground level. Inversion affects only the display of the signal but not the trigger.

For example: if the oscilloscope triggers on the rising edge, the trigger is not changed by inversion, but the actually rising edge is displayed as falling edge.

Inversion is indicated in the waveform labels by line above the channel name.

Remote command:

[CHANnel<m>:POLarity](#) on page 419

Deskew

Sets a time delay for the selected channel.

Deskew compensates delay differences between channels caused by the different length of cables, probes, and other sources. Correct deskew values are important for accurate triggering. Signals that are routed over lines with different lengths have a different propagation delay. This delay can lead to a non-synchronous waveform display. For example, a coax cable with a length of 1 meter has a propagation delay of typically 5.3 ns.

Remote command:

[CHANnel<m>:SKEW](#) on page 420

Zero Adjust

Differences in DUT and oscilloscope ground levels can cause larger zero errors, which affect the waveform. If the DUT is ground-referenced, the "Zero Adjust" corrects the zero error and sets the probe to the zero level.

You can assess the zero error by measuring the mean value of a signal that returns zero.

Remote command:

[CHANnel<m>:ZOFFset\[:VALue\]](#) on page 420

Waveform Color

Selects the color scale for the waveform color. Each scale comprises a set of colors, where each color represents a certain frequency of occurrence.

"Temperature"	Display in temperature colors. Blue corresponds to rare occurrences of the samples, while white indicates frequent ones.
"Rainbow"	Display in rainbow colors. Blue corresponds to rare occurrences of the samples, while red indicates frequent ones.
"Fire"	Display in fire colors. Yellow corresponds to rare occurrences of the samples, while red indicates frequent ones.
"Default"	Displays the waveform in its default monochrome color.

Remote command:

[CHANnel<m>:WCOLor](#) on page 420

Probe

See [Chapter 4.3.4, "Probe Settings for Probes with BNC Connector"](#), on page 52 and [Chapter 4.3.5, "Probe Settings for Probes with Rohde & Schwarz Interface"](#), on page 53.

Threshold

See [Chapter 4.3.6, "Threshold Settings"](#), on page 60.

Label

See [Chapter 4.3.7, "Label Settings"](#), on page 61.

4.3.4 Probe Settings for Probes with BNC Connector

For passive probes, which are connected with a BNC connector, you set the probe attenuation and the unit, and you can start an adjustment procedure for the probe. All settings are channel-specific. When you set the attenuation, you can select a predefined factor, for example "10:1", or enter a user-defined value.

Access: [Ch <n>] > "Probe" (scroll down). Or: short menu > "Probe"

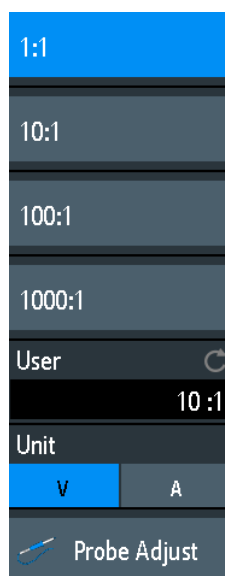
**User**

If default values do not fit, you can enter an arbitrary attenuation factor in the range between 0.001:1 and 1000:1. The vertical scaling and measured values are multiplied by this factor so that the displayed values are equal to the undivided measured signal values.

Remote command:

[PROBe<m>:SETup:ATTenuation:MANual](#) on page 423

[PROBe<m>:SETup:GAIN:MANual](#) on page 424

Unit

Selects the unit that the probe can measure.

- V - for voltage measurements
- A - for current measurements

Remote command:

`PROBe<m>:SETup:ATTenuation:UNIT` on page 423

`PROBe<m>:SETup:GAIN:UNIT` on page 423

Probe Adjust

Starts the probe adjustment procedure. A wizard explains the adjustment step by step.

4.3.5 Probe Settings for Probes with Rohde & Schwarz Interface

Probes with Rohde & Schwarz probe interface have an integrated data memory that contains identification data and individual probe correction parameters. The R&S RTM3000 can detect these probes and read out the data, for example, bandwidth, termination and attenuation. These parameters do not need any adjustment.

Other parameters, like the offset value for the selected channel, the micro button action and other probe-specific settings are defined in the probe menu. The probe menu opens automatically when the probe is plugged in.

Access: [Ch <n>] > "Probe" (scroll down). Or: short channel menu > "Probe"

The menu provides the settings for the recognized probe. If no probe is recognized, the default probe menu for BNC-connected probes is shown. The channel label at the bottom shows the probe type, and coupling or termination.

4.3.5.1 Active Broadband Single-Ended Probes

Active single-ended probes like R&S RT-ZS10 and R&S RT-ZS20 provide special features: the micro button and the ProbeMeter. The ProbeMeter measures DC voltages between the probe tip and ground. Special features are available in the "Probe" menu if the probe is connected and recognized by the instrument.

Access: [Ch <n>] > "Probe" (scroll down); or short menu > "Probe"

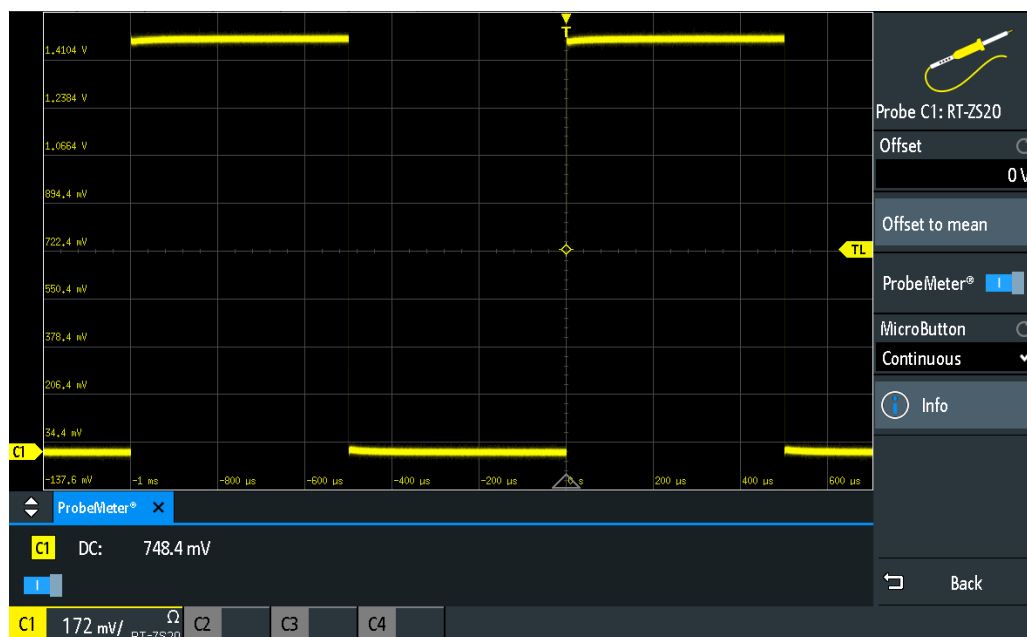

Figure 4-3: Probe settings of R&S RT-ZS20 with ProbeMeter measurement

Offset

Same as "Offset" in the "Vertical" menu, see "Offset" on page 50.

Offset to mean

Sets the offset to the mean value of the ProbeMeter's DC measurement.

ProbeMeter®

Shows the measurement result of the integrated R&S ProbeMeter of active Rohde & Schwarz voltage probes.

If a single-ended or power rail probe is connected, the ProbeMeter measures DC voltages between the probe tip and ground connection and enables ground-referenced measurements of voltages.

If a differential probe is connected, the ProbeMeter measures differential and common mode voltages.

The ProbeMeter measures continuously and in parallel to the measurements of the oscilloscope. The results are shown below the grid. You can switch off the ProbeMeter using the button below the results.

Remote command:

[PROBe<m>:SETup:OFFSwitch](#) on page 424

[PROBe<m>:SETup:DCOffset?](#) on page 425

MicroButton

Active Rohde & Schwarz probes have a configurable micro button on the probe head. Pressing this button, you can perform an action on the instrument directly from the probe. During internal automatic processes the button is disabled, for example, during self alignment, autoset, and find level.

Select the action that you want to start from the probe.

"None"	Select this option to prevent unwanted actions due to unintended usage of the micro button.
"Continuous"	Starts continuous acquisition, like the [Run Stop] key. The acquisition is running as long as you press the micro button again.
"Single"	Starts one acquisition.
"Autoset"	Starts the autoset procedure.
"Probe Menu"	Opens the probe menu.
"ProbeMeter®"	Shows or hides the result of the ProbeMeter measurement.
"Screenshots"	Saves a screenshot.
"OneTouch"	Initiates the assigned OneTouch actions, same effect as pressing the  key.
"Offset to mean"	Sets the offset to the mean value of the ProbeMeter's DC measurement.

Remote command:

[PROBe<m>:SETup:MODE](#) on page 425

Info

Shows general information on the connected probe, for example, type, serial number, and production date. Below, electrical characteristics are shown, like bandwidth, attenuation, input capacitance and impedance, voltage and DC offset range.

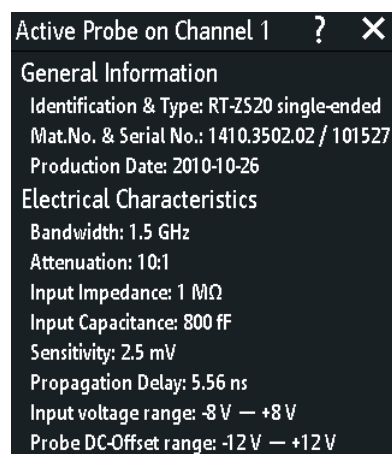

Remote command:

[PROBe<m>:SETup:NAME?](#) on page 427

[PROBe<m>:ID:BUILd?](#) on page 425

[PROBe<m>:ID:PARTnumber?](#) on page 426

[PROBe<m>:ID:PRDate?](#) on page 426

[PROBe<m>:ID:SRNumber?](#) on page 426

[PROBe<m>:ID:SWVersion?](#) on page 426

[PROBe<m>:SETup:BANDwidth?](#) on page 427

[PROBe<m>:SETup:ATTenuation\[:AUTO\]?](#) on page 427

[PROBe<m>:SETup:GAIN\[:AUTO\]?](#) on page 428

[PROBe<m>:SETup:CAPacitance?](#) on page 428

[PROBe<m>:SETup:IMPedance?](#) on page 428

4.3.5.2 Active Broadband Differential Probes

Active differential probes like R&S RT-ZD10 and R&S RT-ZD20 provide special features: the micro button and the ProbeMeter. The ProbeMeter measures the differential and common mode voltages. Special features are available in the "Probe" menu if the probe is connected and recognized by the instrument.

Access: [Ch <n>] > "Probe" (scroll down); or short menu > "Probe"

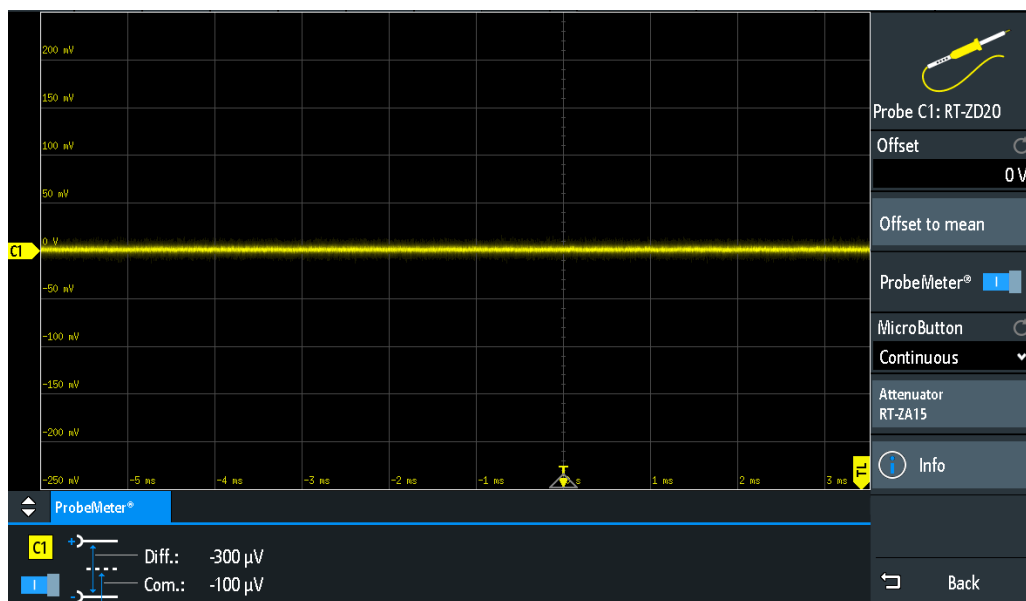

Figure 4-4: Probe settings of R&S RT-ZD20 with ProbeMeter measurement

Offset

Same as "Offset" in the "Vertical" menu, see ["Offset"](#) on page 50.

Offset to mean

Same as "Offset to mean" for active broadband single-ended probes, see ["Offset to mean"](#) on page 54.

ProbeMeter®

Same as "ProbeMeter®" for active broadband single-ended probes, see ["ProbeMeter®"](#) on page 54.

MicroButton

Same as for active single-ended probes, see ["MicroButton"](#) on page 54.

Info

Same as for active single-ended probes, see ["Info"](#) on page 55.

Attenuator RT-ZA15

If you use the external attenuator R&S RT-ZA15 together with one of the differential active probes R&S RT-ZD, enable "Attenuator RT-ZA15" to include the external attenuation in the measurements.

4.3.5.3 Current Probes

Rohde & Schwarz provides current probes with different output connectors: BNC or Rohde & Schwarz probe box.

Current probes R&S RT-ZCxx

The current probes **R&S RT-ZCxx** have BNC connectors. The setup is described in [Chapter 4.3.4, "Probe Settings for Probes with BNC Connector"](#), on page 52. Demagnetizing and zero adjustment is done on the probe, see the probe's User Manual for details. Make sure to demagnetize and adjust the probe before taking measurements.

Current probes R&S RT-ZCxxB

Current probes **R&S RT-ZCxxB** have a Rohde & Schwarz probe interface; they are powered and remotely controlled by the oscilloscope.

When the probe is connected, demagnetization is performed automatically.

Access: [Ch <n>] > "Probe" (scroll down); or short menu > "Probe"

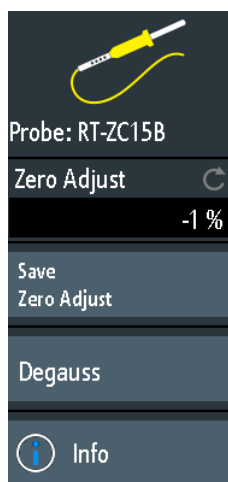
**Zero Adjust**

Sets the waveform to zero position. After demagnetizing, always carry out a zero adjustment. The setting corresponds to [Zero Adjust](#) in the channel menu but the value is set in %.

Save Zero Adjust

Saves the "Zero Adjust" value in the probe box. If you connect the probe to another channel or to another R&S RTx oscilloscope, the value is read out again.

Degauss

Demagnetizes the core if it has been magnetized by switching the power on and off, or by an excessive input. Always carry out demagnetizing before measurement. The demagnetizing process takes about one second. During demagnetizing, a demagnetizing waveform is present at the output.

Remote command:

PROBe<m>:SETup:DEGauss on page 429

Info

Same as for active single-ended probes, see "Info" on page 55.

4.3.5.4 High-Voltage Differential Probes

Rohde & Schwarz high-voltage differential probes of the R&S RT-ZHD series have the same settings as active broadband differential probes, and additional range settings. Other high-voltage differential probes have a BNC interface, for setup, see [Chapter 4.3.4, "Probe Settings for Probes with BNC Connector"](#), on page 52.

Access: [Ch <n>] > "Probe" (scroll down); or short menu > "Probe"

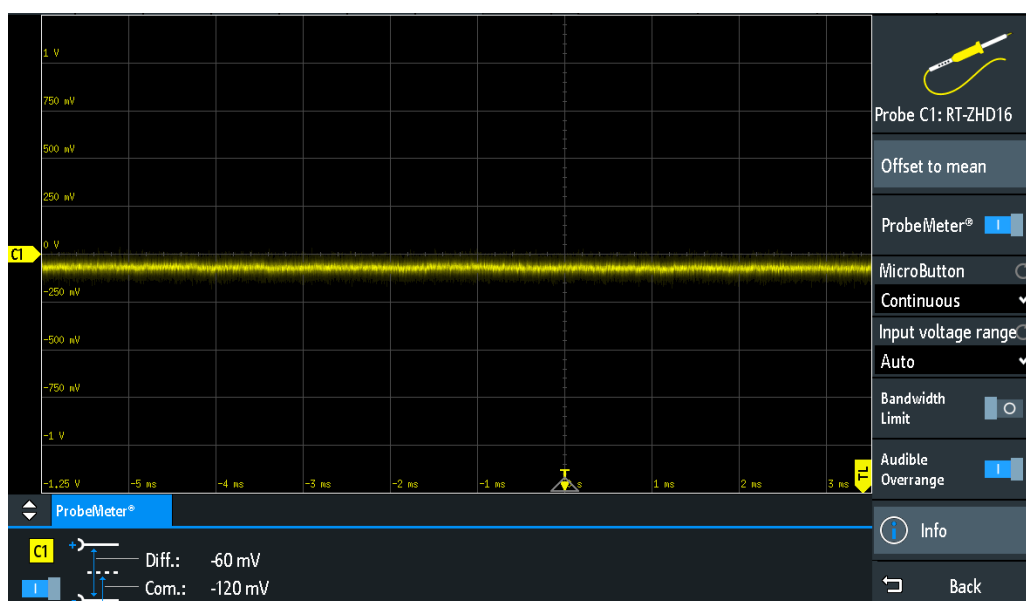

Figure 4-5: Probe settings of R&S RT-ZHD16 with results of ProbeMeter measurement

Offset to mean

Same as "Offset to mean" for active broadband single-ended probes, see ["Offset to mean"](#) on page 54. The offset value is shown in the "Channel <n>" menu.

ProbeMeter®

Same as "ProbeMeter®" for active broadband single-ended probes, see ["ProbeMeter®"](#) on page 54.

MicroButton

Same as for active single-ended probes, see "[MicroButton](#)" on page 54.

Input voltage range

Sets the voltage range of a R&S RT-ZHD probe. You can set the range on the probe control box or at the oscilloscope.

- | | |
|----------------|--|
| "Auto" | The voltage range is set only at the oscilloscope by adjusting the vertical scale. |
| "<High value>" | Sets the higher voltage range of the connected probe. The selection list shows the value that is specified on the probe. |
| "<Low value>" | Sets the lower voltage range of the connected probe. The selection list shows the value that is specified on the probe. |

Bandwidth Limit

Activates the lowpass filter in the probe control box. You can also set the filter directly on the probe control box. The limit depends on the probe type and is shown on the probe control box.

Audible Overrange

Activates the acoustic overrange warning in the probe control box. You can also activate the sound directly on the probe control box.

Info

Same as for active single-ended probes, see "[Info](#)" on page 55.

4.3.5.5 Power Rail Probes

Rohde & Schwarz power rail probes like R&S RT-ZPR20 have a Rohde & Schwarz probe interface with ProbeMeter, but no micro button. R&S RT-ZPR probes require 50 Ω termination, which is set automatically. The ProbeMeter measures DC voltages between the probe tip and ground.

Access: [Ch <n>] > "Probe" (scroll down).

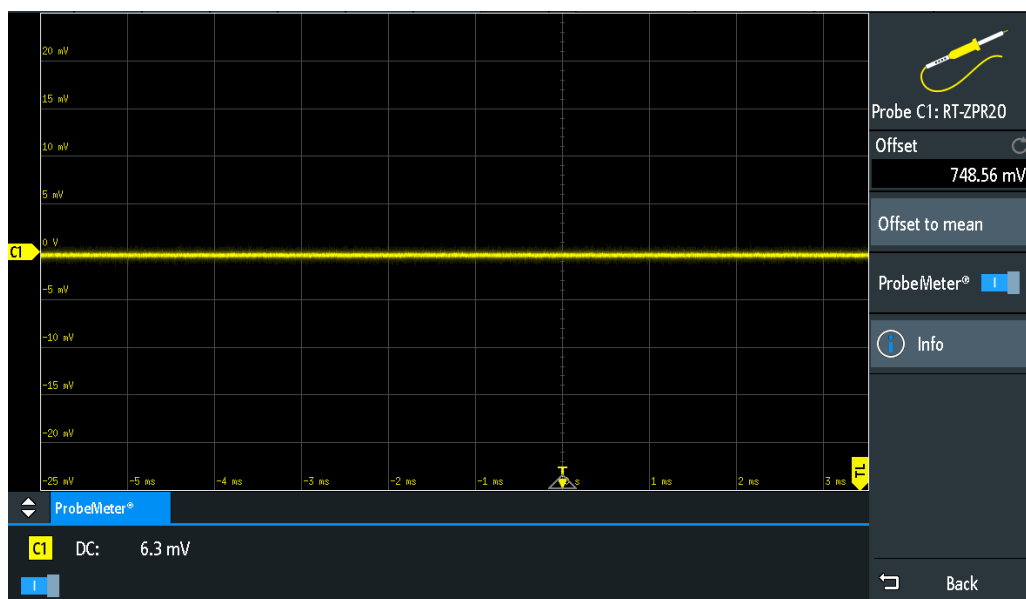

Figure 4-6: Probe settings of R&S RT-ZPR20 with ProbeMeter measurement

Offset

Same as "Offset" in the "Vertical" menu, see ["Offset"](#) on page 50.

Offset to mean

Same as "Offset to mean" for active broadband single-ended probes, see ["Offset to mean"](#) on page 54.

ProbeMeter®

Same as "ProbeMeter®" for active broadband single-ended probes, see ["ProbeMeter®"](#) on page 54.

Info

Same as for active single-ended probes, see ["Info"](#) on page 55.

4.3.6 Threshold Settings

A threshold is used for digitization of analog signals. If the signal value is higher than the threshold, the signal state is high (1 or true for the Boolean logic). Otherwise, the signal state is considered low (0 or false) if the signal value is below the threshold.

Access: [Ch <n>] > "Threshold" (scroll down).



Threshold

A threshold is used for digitization of analog signals. If the signal value is higher than the threshold, the signal state is high (1 or true for the Boolean logic). Otherwise, the signal state is considered low (0 or false) if the signal value is below the threshold.

Remote command:

[CHANnel<m>:THReshold](#) on page 421

Hysteresis

To avoid the change of signal states due to noise, set the hysteresis. If the signal oscillates inside the hysteresis range and crosses the threshold, no state transition occurs.

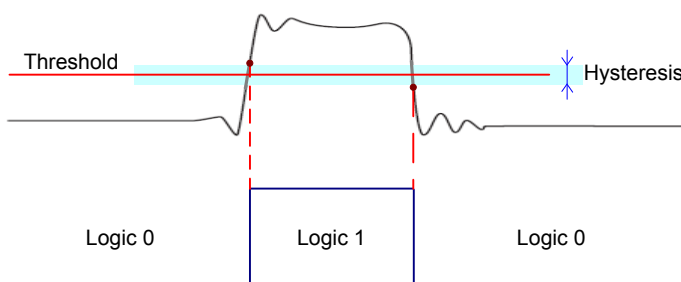

The numerical values of "Small", "Medium", and "Large" hysteresis correspond to the vertical scale.

Remote command:

[CHANnel<m>:THReshold:HYSTeresis](#) on page 422

Find Threshold

The instrument analyzes the channel and sets the threshold for digitization. If no level can be found, the existing value remains unchanged, and you can set the thresholds manually.

Remote command:

[CHANnel<m>:THReshold:FINDlevel](#) on page 422

4.3.7 Label Settings

In the "Label" menu, you can define a name label for the selected waveform.

Access: [Ch <n>] > "Label" (scroll down).

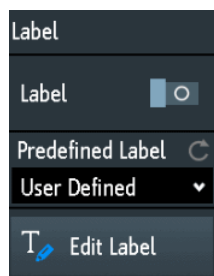

Label

Activates or deactivates the label display. The label is shown at the waveform on the right edge of the display.

Remote command:

[CHANnel<m>:LAbel:STATe](#) on page 422

[CHANnel<m>:LAbel](#) on page 422

Predefined Label

Selects a predefined label text. You can edit the text with "Edit Label".

Edit Label

Opens on-screen keypad to enter a label text. If you previously have selected a predefined label, it is already written in the entry line, and you can modify it.

The maximum name length is 8 characters, and only ASCII characters provided on the on-screen keypad can be used.

4.4 Horizontal Setup

Horizontal settings, also known as timebase settings, adjust the waveforms in horizontal direction.

Typically, the trigger is the determining point of the waveform record. In many scenarios, you want to analyze the waveform some time before or after the trigger. To adjust the horizontal acquisition window to the waveform section of interest, you can use the following parameters:

- The **horizontal position** defines the time distance of the trigger point (the zero point of the diagram) to the reference point. Changing the horizontal position, you can move the trigger point, even outside the screen.
- The **reference point** is the rescaling center of the time scale on the screen. If you modify the time scale, the reference point remains fixed on the screen, and the scale is stretched or compressed to both sides of the reference point.

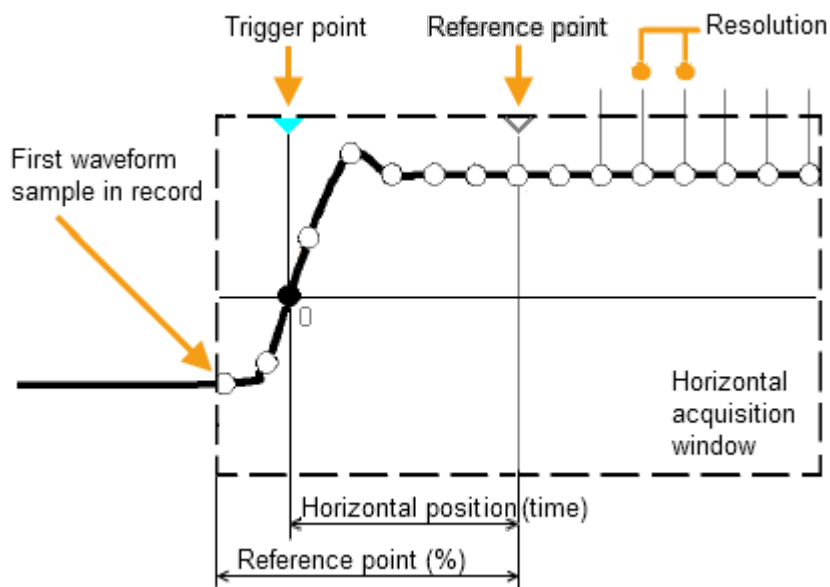

Unlike vertical settings, which are waveform-specific, the horizontal settings apply to all active waveforms.

There are several ways to adjust horizontal settings:

- Use the controls in the Horizontal functional block of the front panel to scale the waveforms, and to set the position.
- Drag one finger horizontally on the screen to change the horizontal position. Spread or pinch two fingers to change the horizontal scale.
- Use shortcuts to adjust scale and position.
- Use the comprehensive menu to adjust all horizontal settings.

4.4.1 HORIZONTAL Controls



[Position]

Changes the trigger position, the time distance from the trigger point to the reference point (trigger offset). The trigger point is the zero point of the diagram. Thus, you can set the trigger point even outside the diagram and analyze the signal some time before or after the trigger.

Turn clockwise to move the position to the right, and press the knob to reset the value to zero. The current value is shown in the information bar.

In zoom and FFT, the knob sets the position in the active diagram. Tap the diagram that you want to adjust. If a zoom is active, either the position of the zoom window or the trigger position is changed. In an FFT diagram, the knob changes the center frequency in frequency domain, or the trigger position in time domain.

Remote command:

[TIMEbase:POSition](#) on page 429

[REFCurve<m>:HORizontal:POSition](#) on page 459

[TIMEbase:ZOOM:TIME](#) on page 451

[Scale]

Adjusts the time scale of the horizontal axis for all signals, also known as timebase.

Turn clockwise to stretch the waveforms - the scale value time/div decreases. Press the knob to toggle between coarse and fine scale adjustment. The current value is shown in the information bar.

In a zoom diagram, the knob changes the zoom scale. In an FFT diagram, the knob changes the span. Tap the diagram that you want to adjust.

Remote command:

[TIMEbase:SCALE](#) on page 429

[REFCurve<m>:HORizontal:SCALE](#) on page 459

[TIMEbase:ZOOM:SCALE](#) on page 451

[Zoom]

Enables or disables the zoom with the last configuration.

See also: [Chapter 6.1, "Zoom"](#), on page 93.

Remote command:

[TIMEbase:ZOOM:STATE](#) on page 451

[Horizontal]

Opens the menu to configure horizontal scale, position, and reference point. The current scale and position is shown in the top information bar.

If zoom is active, you can find also the zoom scale and zoom position in this menu.

[Acquisition]

Opens the "Acquisition" menu. Here you control the data processing - how the waveform is built from the captured samples. The current acquisition mode is shown in the top information bar.

See also: [Chapter 4.5, "Acquisition Setup"](#), on page 66.

4.4.2 Shortcuts for Horizontal Settings

To adjust the horizontal scale and the position, you can use the shortcuts on the top of the display. The labels show the current values.

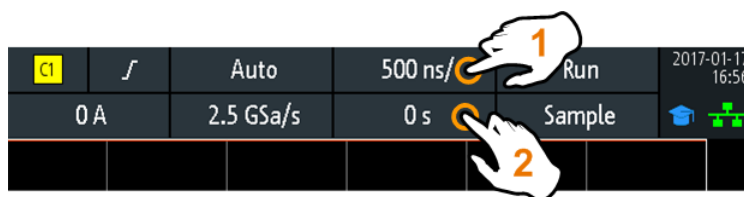

- 1 = adjust horizontal scale
2 = adjust horizontal position

4.4.3 Horizontal Settings

The comprehensive "Horizontal" menu contains all horizontal settings. In zoom mode, also zoom settings are listed in the menu.

- To open the menu, press the [Horizontal] key.

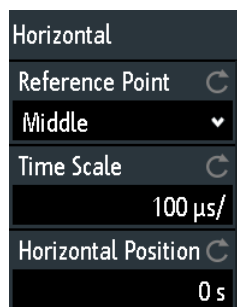

Reference Point

Defines the time reference point in the diagram. It is indicated by a gray triangle outline at the bottom of the diagram.

The reference point defines which part of the waveform is shown. By default, the reference point is displayed in the center of the window, and you can move it to the left or right.

The reference point is the rescaling center of the time scale on the screen. If you modify the time scale using the [Scale] knob, the reference point remains fixed on the screen, and the scale is stretched or compressed to both sides of the reference point. If you spread and pinch two fingers on the touchscreen to change the time scale, then the reference point is set between the fingers.

Remote command:

[TIMebase:REFerence](#) on page 430

Time Scale

Defines the time scale of the horizontal axis for all signals, also known as timebase. The scaling is indicated in the information bar above the grid.

Remote command:

[TIMebase:SCALE](#) on page 429

Horizontal Position

Defines the trigger position, the time distance from the trigger point to the reference point (trigger offset). The trigger point is the zero point of the diagram. Changing the horizontal position, you can move the trigger, even outside the screen.

If you want to see a section of the waveform some time before or after the trigger, enter this time as horizontal position. The requested waveform section is shown around the reference point. Use positive values to see waveform sections after the trigger - the waveform and the diagram origin move to the left.

The value is indicated in the information bar above the grid.

Remote command:

[TIMEbase:POSition](#) on page 429

4.5 Acquisition Setup

During an acquisition, the R&S RTM3000 captures the signal and converts it to digital samples. The digital samples are processed according to the acquisition settings. The result is a waveform record that is displayed on the screen and stored in memory.

The number of waveform samples in one waveform record is called the record length. The rate of recording waveform samples - the number of waveform samples per second - is the sample rate. The higher the sample rate, the better is the resolution and the more details of the waveform are visible.

A sufficient resolution is essential for correct reconstruction of the waveform. If the signal is undersampled, aliasing occurs - a false waveform is displayed. To avoid aliasing and accurately reconstruct a signal, the sample rate must be at least 3 to 5 times the fastest frequency component of the signal.

There are several ways to adjust and control acquisition:

- Use the controls in the Trigger functional block of the front panel to start and stop acquisition. See [Chapter 5.1, "Trigger Controls"](#), on page 72.
 - Use shortcuts to adjust the acquisition mode, and to perform a single acquisition.
 - Use the comprehensive menu to adjust all acquisition settings.
- ▶ To start or stop acquisition, use the [Run Stop] and [Single] keys in the Trigger section at the front panel.

4.5.1 Shortcuts for Acquisition Settings

To adjust the acquisition mode, and to perform a single acquisition, you can use the shortcuts on the top of the display. The labels show the current values.

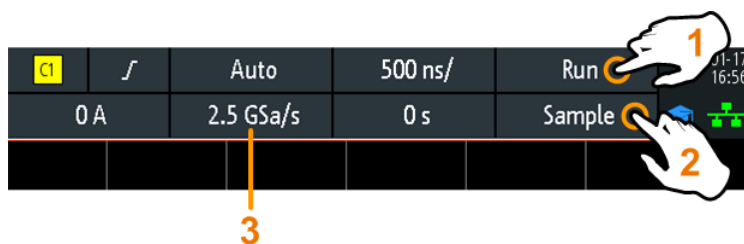

- 1 = start or stop a continuous acquisition, or start a single acquisition if [Single] is active
- 2 = adjust the acquisition mode
- 3 = shows the current sample rate for information

4.5.2 Acquisition Settings

Acquisition settings define the processing of the captured samples in the instrument. The current acquisition mode and sample rate are shown in the top information bar.

- To adjust acquisition settings, press the [Acquisition] key.

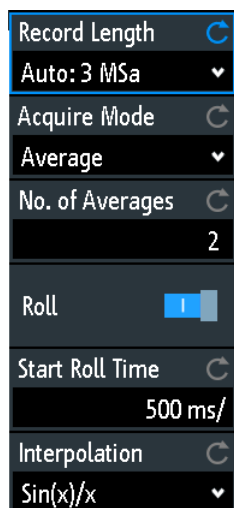

The history is described in [Chapter 6.4.3, "History Settings"](#), on page 114.

Record Length

Sets the record length, the number of waveform samples that are stored in one waveform record.

If you use the history, you can disable the "Auto" record length and enter a value in the "History" menu. In this case, the defined record length is shown in the "Acquisition" menu.

Remote command:

[ACQUIRE:POINTS:AUTOMATIC](#) on page 431

[ACQUIRE:POINTS\[:VALUE\]](#) on page 431

Acquire Mode

Defines how the waveform is built from the captured samples. There are two general methods to build the waveform record: sample decimation and waveform arithmetic.

Sample decimation reduces the data stream of the ADC to a stream of waveform points with lower sample rate and a less precise time resolution. The R&S RTM3000 uses decimation, if the waveform sample rate is less than the ADC sample rate. The acquisition modes "Peak Detect" and "High Resolution" are decimation methods.

Waveform arithmetic builds the resulting waveform from several consecutive acquisitions of the signal. The acquisition modes "Average" and "Envelope" are arithmetic methods.

"Sample"	<p>Usually, most signals are displayed optimally with this acquisition mode but very short glitches might remain undiscovered by this method.</p> <p>If the sample rate of the waveform is less than the ADC sample rate, the instrument reduces the number of samples: one of n samples in a sample interval is recorded as waveform point, the other samples are discarded (decimation). Conversely, if the sample rate of the waveform is higher than the ADC sample rate, the instrument adds waveform points to the captured samples using an interpolation method.</p>
"Peak Detect"	<p>The minimum and the maximum of n samples are recorded as waveform points, the other samples are discarded. Thus the instrument can detect fast signal peaks at slow time scale settings that would be missed with other acquisition modes.</p>
"High Resolution"	<p>The average of n captured sample points is recorded as one waveform sample. Averaging reduces the noise, the result is a more precise waveform with higher vertical resolution.</p>
"Average"	<p>The average is calculated from the data of the current acquisition and a number of consecutive acquisitions before. The method reduces random noise. It requires a stable, triggered and repetitive signal. The number of acquisitions for average calculation is defined with "No. of Averages" on page 69.</p>
"Average + HR"	<p>Combines the high resolution mode with averaging over several acquisitions.</p>
"Envelope"	<p>Each acquisition is done in sample mode, and the minimum and maximum values over some consecutive acquisitions build the envelope. The resulting diagram shows two envelope waveforms below and above the normal waveform: the minimums (floor) and maximums (roof), representing the borders in which the signal occurs. This method is useful, for example, if the waveform is noisy but the noise is not relevant for the measurement.</p>
"Envelope + PD"	<p>Each acquisition is done in peak detect mode, and the most extreme values of all consecutive acquisitions build the envelope. This method is more precise than "Envelope".</p>
"Envelope + HR"	<p>Each acquisition is done in high resolution mode, and the minimum and maximum values over some consecutive acquisitions build the envelope.</p>

Remote command:

[CHANnel<m>:ARITHmetics](#) on page 432

[CHANnel<m>:TYPE](#) on page 432

[ACQUIRE:PEAKdetect](#) on page 433

[ACQUIRE:HRESolution](#) on page 433

No. of Averages

Defines the number of waveforms used to calculate the average waveform. The higher the number, the better the noise is reduced.

To restart the average calculation, press the [Clear Screen] key.

Remote command:

[ACQUIRE:AVERage:COUNT](#) on page 433

[ACQUIRE:AVERage:RESet](#) on page 433

Nx Single

Sets the number of waveforms that are acquired with a [Single] acquisition.

The setting is available if the history option is installed.

Remote command:

[ACQUIRE:NSINGle:COUNT](#) on page 415

Roll

Enables the automatic roll mode. The instrument switches to roll mode if the [Time Scale](#) is equal or slower than [Start Roll Time](#).

The roll mode displays the untriggered, continuous signal, and moves the captured input data on the display from the left to the right. The instrument shows the waveform immediately, without waiting for the complete acquisition of the waveform record. The record length is set automatically ("Auto" mode). Some math functions are non-calculable if roll mode is active.

You can use the horizontal and vertical zoom in roll mode if the acquisition is stopped.

Remote command:

[TIMEbase:ROLL:AUTomatic](#) on page 434

Start Roll Time

Sets the limit timebase for the roll mode. The instrument switches automatically to roll mode if:

- the [Time Scale](#) exceeds the value given here.
- the roll mode is activated ([Roll](#)).

Remote command:

[TIMEbase:ROLL:MTIME](#) on page 434

Interpolation

Selects the interpolation method if interpolation is required to get the defined record length.

- "Sin(x)/x" Two adjacent ADC sample points are connected by a $\sin(x)/x$ curve, and also the adjoining sample points are considered by this curve. The interpolated points are placed on the resulting curve. This interpolation method is the default method. It is precise and shows the best signal curve.
- "Linear" Two adjacent ADC sample points are connected by a straight line, the interpolated points are placed on the line. You see a polygonal waveform similar to the real signal, and also the ADC sample points as vertexes.
- "Sample-Hold" The ADC sample points are displayed like a histogram. For each sample interval, the voltage is taken from the sample point and considered as constant, and the intervals are connected with vertical lines. Thus, you see the discrete values of the ADC.

Remote command:

[ACQUIRE:INTerpolate](#) on page 434

5 Trigger

Triggering means to capture the interesting part of the relevant waveforms. Choosing the right trigger type and configuring all trigger settings correctly allows you to detect various incidents in signals.

A trigger occurs if the trigger conditions are fulfilled. The instrument acquires continuously and keeps the sample points to fill the pretrigger part of the waveform record. When the trigger occurs, the instrument continues acquisition until the posttrigger part of the waveform record is filled. Then it stops acquiring and displays the waveform. When a trigger is recognized, the instrument does not accept another trigger until the acquisition is complete.

Trigger conditions include:

- Source of the trigger signal (channel)
- Trigger type and its setup
- Trigger mode

In addition, the horizontal position of the trigger point and the reference point are important to display the interesting part of the signal. See [Chapter 4.4, "Horizontal Setup"](#), on page 62.

The trigger level and position are marked in the grid. The markers have the color of the trigger source. Information on the most important trigger settings is shown in the upper information bar.

There are several ways to set up the trigger:

- Use the controls in the Trigger functional block of the front panel.
- Use shortcuts to adjust the trigger source, trigger mode, and main parameters of the trigger type.
- Use the comprehensive menu to select the trigger type and to adjust all trigger settings.

The R&S RTM3000 can output a pulse at the Aux Out connector when the instrument triggers. See

• Trigger Controls	72
• Shortcuts for Trigger Settings	73
• General Trigger Settings	74
• Edge Trigger	76
• Edge A/B Trigger	78
• Width Trigger	79
• Video Trigger	82
• Pattern Trigger	84
• Runt Trigger	87
• Rise Time Trigger	88
• Timeout Trigger	90
• Trigger Out Signal	92

5.1 Trigger Controls

The keys and the rotary knob in the Trigger functional block adjust the trigger and start or stop acquisition.

The green LED above the [Levels] knob lights up when the instrument triggers.



[Trigger]

Opens the "Trigger" menu.

[Source]

Changes the analog trigger source. Press the key repeatedly until the required analog source is selected. If a digital source or serial bus was selected in the "Trigger" menu, or if the "Trigger Type" is set to "Pattern", the key opens the menu.

The key lights up in the color of the selected channel, and the selected source is shown in the information bar.

Remote command:

[TRIGger:A:SOURce](#) on page 436

[Auto Norm]

Toggles the trigger mode between "Auto" and "Norm". The key lights up in white if the trigger mode is "Norm". The current mode is also shown in the information bar.

"Auto" The instrument triggers repeatedly after a time interval if the trigger conditions are not fulfilled. If a real trigger occurs, it takes precedence. This mode helps to see the waveform even before the trigger is set. The waveform on the screen is not synchronized, and successive waveforms are not triggered at the same point of the waveform.

"Norm" The instrument acquires a waveform only if a trigger occurs, that is, if all trigger conditions are fulfilled. If no trigger occurs, no waveform is acquired and the last acquired waveform is displayed. If no waveform was captured before, nothing is displayed.

Remote command:

[TRIGger:A:MODE](#) on page 436

[Levels]

The rotary knob changes the trigger level. Turn clockwise to move up the trigger level.

Pressing the knob sets the level to 50% of the signal amplitude.

Remote command:

[TRIGger:A:LEVel<n>\[:VALue\]](#) on page 438

[TRIGger:A:FINDlevel](#) on page 438

[Force Trigger]

Provokes an immediate single acquisition. Use this key if the acquisition is running in normal mode and no valid trigger occurs. Thus, you can confirm that a signal is available and use the waveform display to determine how to trigger on it.

Remote command:

[*TRG](#) on page 414

[Run Stop]

Starts and stops the continuous acquisition. A green light indicates a running acquisition. A red light shows that acquisition is stopped.

The status is shown also at the right end of the information bar: "Run", "Complete", "Trig?" (waiting for trigger, in normal trigger mode) or "Not ready" (working). For slow timebases, the status "Pre" or "Post" is shown together with an indicator that shows the filling level of the buffer.

Remote command:

[RUN](#) on page 415

[RUNContinuous](#) on page 415

[STOP](#) on page 416

[ACQuire:STATe](#) on page 416

[Single]

Starts a specified number of acquisitions. A white light indicates that the instrument is in single mode. The information bar shows "Complete" if the acquisition has been finished.

If the history option R&S RTM3000-K15 is available, you can set the number of acquisitions: press the [Acquisition] key and enter "Nx Single".

Remote command:

[SINGle](#) on page 415

[RUNSingle](#) on page 415

5.2 Shortcuts for Trigger Settings

To adjust the trigger source, mode, and trigger type specific settings, you can use the shortcuts on the top of the display. The labels show the current values.

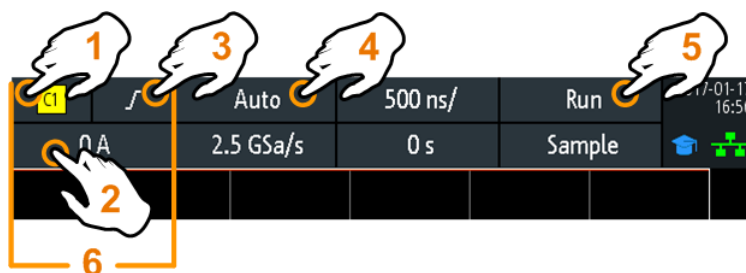

- 1 = adjust the trigger source
- 2 = open the keypad to enter the value of the trigger level or threshold
- 3 = adjust slope or polarity
- 4 = adjust the trigger mode
- 5 = start or stop a continuous acquisition, or start a single acquisition if [Single] is active
- 6 = available settings depend on the trigger type

5.3 General Trigger Settings



General trigger settings are independent of the trigger type. They are highlighted in the above figure and described in the current section. The other trigger settings are specific for individual trigger types, and they are described in the following sections.

Trigger Mode

Toggles the trigger mode between "Auto" and "Norm". The trigger mode determines the behavior of the instrument if no trigger occurs. The current setting is shown in the information bar.

- "Auto" The instrument triggers repeatedly after a time interval if the trigger conditions are not fulfilled. If a real trigger occurs, it takes precedence. This mode helps to see the waveform even before the trigger is set. The waveform on the screen is not synchronized, and successive waveforms are not triggered at the same point of the waveform.
- "Norm" The instrument acquires a normal waveform only, if a trigger occurs, that is, if all trigger conditions are fulfilled. If no trigger occurs, no waveform is acquired and the last acquired waveform is displayed. If no waveform was captured before, nothing is displayed.

Remote command:

[TRIGger:A:MODE](#) on page 436

Trigger Type

Selects the trigger type.

- "Edge" Triggers on signal edges.
See [Chapter 5.4, "Edge Trigger"](#), on page 76.
- "Edge A/B" Triggers on a sequence of two edge trigger conditions.
See [Chapter 5.5, "Edge A/B Trigger"](#), on page 78
- "Width" Triggers on pulse width.
See [Chapter 5.6, "Width Trigger"](#), on page 79.
- "Video" Triggers on various PAL, NTSC and HDTV standard video signals.
See [Chapter 5.7, "Video Trigger"](#), on page 82.
- "Pattern" Triggers on logical combinations of the input channels.
See [Chapter 5.8, "Pattern Trigger"](#), on page 84.
- "Runt" Triggers on pulses lower than normal in amplitude.
See [Chapter 5.9, "Runt Trigger"](#), on page 87.
- "Risetime" Triggers on fast or slow rising or falling edges.
See [Chapter 5.10, "Rise Time Trigger"](#), on page 88.
- "Timeout" Triggers on signal level timeout.
See [Chapter 5.11, "Timeout Trigger"](#), on page 90.
- "Line" The line trigger uses the waveform of the power supply's alternating line voltage (typically 50 Hz or 60 Hz AC) as the trigger signal source. Use this trigger to detect issues related to the frequency of the power grid.
The line trigger does not have any settings.
- "Serial Bus" Triggers on a serial bus. Requires that at least one protocol option R&S RTM-K1, -K2, or -K3 is installed, a serial bus is configured, and a decoded signal is available.
See [Chapter 12.1.1, "Protocol - Common Settings"](#), on page 231.

Remote command:

[TRIGger:A:TYPE](#) on page 437

Source

Selects the trigger source.

"C1, C2, C3, C4"	Select one of the analog input channels as trigger source.
"D0 to D15"	Select one of the digital channels as trigger source if MSO option R&S RTM-B1 is installed. Not available for video, runt, and risetime trigger.
"Extern"	Sets the external trigger input on the front panel as trigger source. Available for edge and video trigger.
"B1, B2, B3 or B4"	Serial bus that is used for triggering on protocols. Only available, if the trigger type "Serial Bus" is selected.

Remote command:

[TRIGger:A:SOURce](#) on page 436

Hold Off, Hold Off Time

Enables the hold off and defines the "Hold Off Time". The next trigger occurs only after the hold off time has passed.

The trigger "Hold Off" defines when the next trigger event is recognized after the current trigger event. Thus, it affects the next trigger to occur after the current one. Hold off helps to obtain stable triggering when the oscilloscope is triggering on undesired events.

Remote command:

[TRIGger:A:HOLDoff:MODE](#) on page 437

[TRIGger:A:HOLDoff:TIME](#) on page 438

5.4 Edge Trigger

The edge trigger is the most common trigger type. The trigger occurs when the signal from the trigger source passes the trigger level in the specified direction (slope).

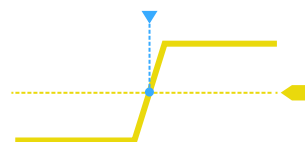
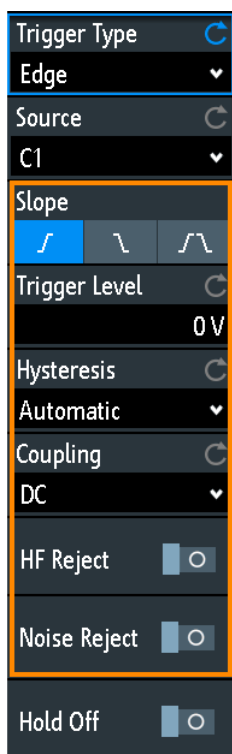

Figure 5-1: Edge trigger event with positive slope (rising edge)

► [Trigger] > "Trigger Type" = "Edge"



Slope..... 77

Trigger Level, Threshold..... 77

Hysteresis..... 78

Coupling..... 78

HF Reject..... 78

Noise Reject..... 78

Slope

Sets the edge direction for the trigger. You can trigger on:

- rising edge, that is a positive voltage change
- falling edge, that is a negative voltage change
- rising and falling edge. After starting an acquisition, the instrument triggers on the first identified edge.

Remote command:

`TRIGger:A:EDGE:SLOPe` on page 438

Trigger Level, Threshold

Sets the voltage level or threshold for the trigger.

You can also drag the trigger level marker on the display, or turn the Levels knob. To set the trigger level to 50% of the signal amplitude, press the Levels knob.

For width and timeout trigger, the trigger level is the threshold of the trigger source.

Remote command:

`TRIGger:A:LEVel<n>[:VALue]` on page 438

`TRIGger:A:FINDlevel` on page 438

Hysteresis

Sets a hysteresis range around the trigger level. Hysteresis avoids unwanted trigger events caused by noise oscillation around the trigger level. The automatic, small, medium, large hysteresis values depend on the vertical scale. On instruments with 1 GHz bandwidth, you can also set the hysteresis to user-defined values.

Remote command:

[TRIGger:A:HYSTeresis](#) on page 439

[TRIGger:A:LEVel<n>:HYSTeresis](#) on page 439

Coupling

Sets the coupling for the trigger source.

"AC"	Alternating current coupling. A highpass filter removes the DC offset voltage from the trigger signal.
"DC"	Direct current coupling. The trigger signal remains unchanged.
"LF Reject"	Sets the trigger coupling to high frequency. A 15 kHz highpass filter removes lower frequencies from the trigger signal. Use this mode only with very high frequency signals.

Remote command:

[TRIGger:A:EDGE:COUpling](#) on page 439

HF Reject

Enables or disables an additional 5 kHz lowpass filter in the trigger path. This filter removes higher frequencies and is available with AC and DC coupling.

You can use either "HF Reject" or "Noise Reject".

Remote command:

[TRIGger:A:EDGE:FILTer:HFReject](#) on page 439

Noise Reject

Extends the hysteresis to avoid unwanted trigger events caused by noise oscillation around the trigger level.

You can use either "HF Reject" or "Noise Reject".

Remote command:

[TRIGger:A:EDGE:FILTer:NREJect](#) on page 440

5.5 Edge A/B Trigger

The edge A/B trigger is a sequence of two edge trigger conditions. The instrument triggers if both edge trigger conditions (A and B) are fulfilled. You can configure a delay between the A- and B-trigger.

► [Trigger] > "Trigger Type" = "Edge A/B" > "Trigger Setup"

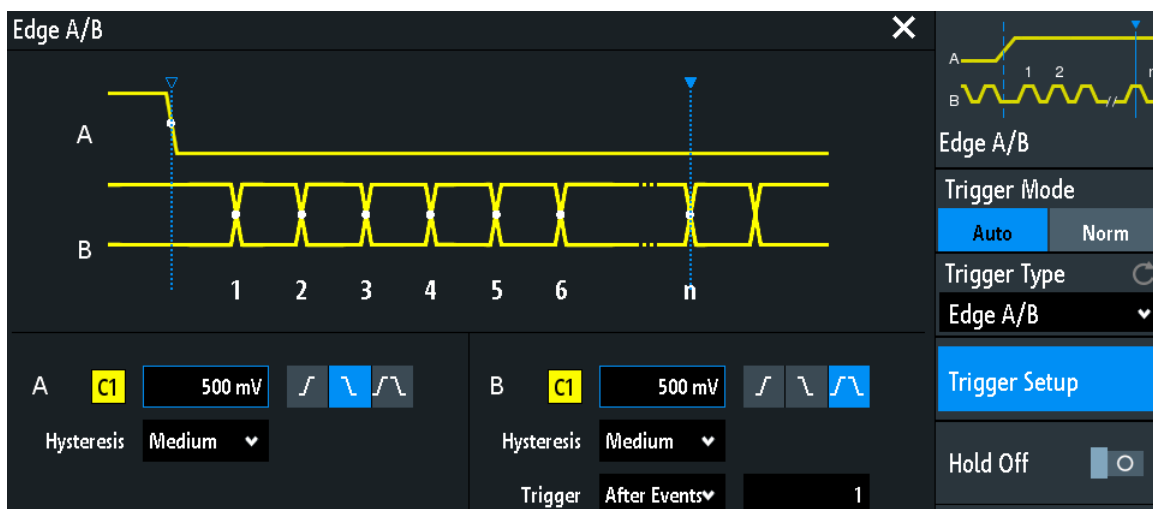

Trigger Setup

Opens a dialog where you configure the trigger sequence. On the left, the first edge trigger (A) is defined as usual. On the right, a second edge trigger (B) is defined with the same parameters: source, level, edge, and hysteresis. The conditions of the B-trigger are considered when the conditions of the A-trigger are met.

In addition, you can set a delay for the B-trigger ("Trigger").

Remote command:

[TRIGger:B:ENABLE](#) on page 440

[TRIGger:B:SOURce](#) on page 440

[TRIGger:B:EDGE:SLOPe](#) on page 441

Trigger

Sets a time delay or event delay for the B-trigger. The instrument waits for that delay after an A-trigger until it recognizes the B-trigger.

"After time" Sets the time the instrument waits until it checks the B-trigger condition.

"After events" Sets a number of B-trigger events that fulfill the B-trigger condition but do not cause the trigger. The oscilloscope triggers on the n-th event, the last of the specified number of events.

Remote command:

[TRIGger:B:MODE](#) on page 441

[TRIGger:B:DELAy](#) on page 441

[TRIGger:B:EVENT:COUNT](#) on page 441

5.6 Width Trigger

The width trigger compares the pulse width (duration) with given time limits. It detects pulses with an exact pulse width, pulses shorter or longer than a given time, and also pulses inside or outside the allowable time range. The pulse width is measured at the trigger level.

You can use the width trigger, for example, to trigger on glitches.

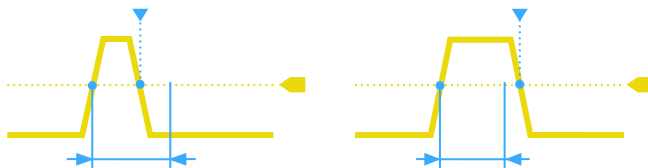

Figure 5-2: Pulse width is shorter (left) or longer (right) than a given duration (also known as glitch trigger)

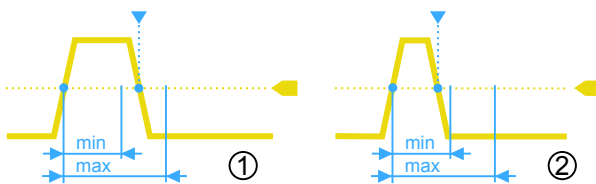

Figure 5-3: Pulse width is inside or outside an allowable time range

- 1 = Inside: min width < pulse < max width
- 2 = Outside: pulse < min width OR pulse > max width

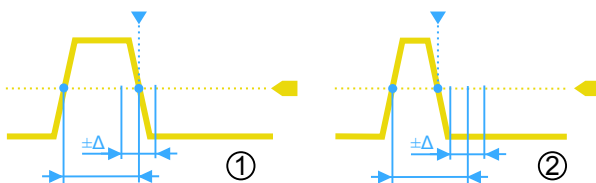

Figure 5-4: Pulse width is equal or unequal to a given duration, with optional variation (Δ)

- 1 = Equal: (width - variation) < pulse < (width + variation)
- 2 = Unequal: pulse < (width - variation) OR pulse > (width + variation)

► [Trigger] > "Trigger Type" = "Width"



Polarity..... 81
 Comparison..... 81
 Time t..... 82
 Variation..... 82
 Time t1, Time t2..... 82
 Threshold..... 82
 Hysteresis..... 82

Polarity

Sets the polarity of the pulse. You can trigger on:

- positive going pulse, the width is defined from the rising to the falling slopes.
- negative going pulse, the width is defined from the falling to the rising slopes.

Remote command:

[TRIGger:A:WIDTH:POLarity](#) on page 442

Comparison

Sets how the measured pulse width is compared with the given limits.

- "Width >" Triggers on pulse width longer than the reference "Time t".
- "Width <" Triggers on pulse width shorter than the reference "Time t".
- "Width =" Triggers on pulse width equal to the reference "Time t" if "Variation" $\Delta t = 0$.
If "Variation" $\neq 0$, this setting triggers on pulses within the range $t \pm \Delta t$.
- "Width \neq " Triggers on pulses unequal to the reference "Time t", if "Variation" $\Delta t = 0$.
If "Variation" $\neq 0$, this setting triggers on pulses outside a range $t \pm \Delta t$.

"Inside"[,]"Out- Triggers on pulses inside or outside a range specified with "Time t1"
side" and "Time t2".

This method is an alternative setting to the range definition with "Time t" and "Variation". The values are interdependent. "Variation" and "Time t" are adjusted, if you change t1 and t2, and vice versa.

Remote command:

`TRIGger:A:WIDTh:RANGe` on page 442

Time t

Sets the reference time, the nominal value for comparison settings "Width >", "Width <", "Width =", and "Width ≠".

Remote command:

`TRIGger:A:WIDTh:WIDTh` on page 442

Variation

Sets a range Δt to the reference "Time t", if comparison is set to "Width =" or "Width ≠". The instrument triggers on pulses inside or outside the range $t \pm \Delta t$.

Remote command:

`TRIGger:A:WIDTh:DELTA` on page 443

Time t1, Time t2

Set the lower and upper time limits defining the time range if "Width =" or "Width ≠" is set for comparison. "Time t" and "Variation" are adjusted accordingly.

Remote command:

`TRIGger:A:WIDTh:RANGe` on page 442

`TRIGger:A:WIDTh:DELTA` on page 443

Threshold

Threshold of the trigger source channel, used as trigger level for the width trigger.

See also "[Threshold](#)" on page 61 and "[Trigger Level, Threshold](#)" on page 77.

Remote command:

`TRIGger:A:LEVel<n>[:VALue]` on page 438

`CHANnel<m>:THReshold` on page 421

Hysteresis

Hysteresis of the trigger source channel, see "[Hysteresis](#)" on page 61.

Remote command:

`CHANnel<m>:THReshold:HYSTeresis` on page 422

5.7 Video Trigger

The video or TV trigger is used to analyze analog baseband video signals. You can trigger on baseband video signals from standard definition and high definition standards connected to an analog channel input or to the external trigger input.

The instrument triggers on the sync pulses.

First select the standard and the signal polarity, then decide to trigger on lines or fields and enter the specific settings.

► [Trigger] > "Trigger Type" = "Video"

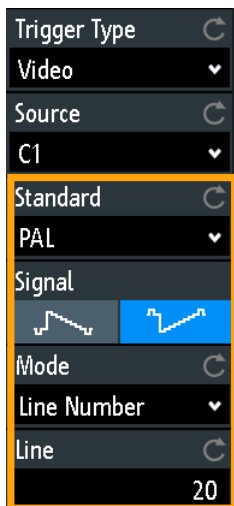

Figure 5-5: Video trigger menu

Standard.....	83
Signal.....	84
Mode.....	84
Line.....	84

Standard

Selects the color television standard.

You can trigger on various standard-definition television (SDTV) signals:

- "PAL"
- "NTSC"
- "SECAM"
- "PAL-M"
- "SDTV 576i" (PAL and SECAM)

High-definition television (HDTV) standards are indicated by the number of active lines and the scanning system:

- "HDTV 720p"
- "HDTV 1080p" (p for progressive scanning)
- "HDTV 1080i" (i for interlaced scanning)

Remote command:

[TRIGger:A:TV:STANdard](#) on page 443

Signal

Selects the polarity of the signal. Note that the sync pulse has the opposite polarity. If the video modulation is positive, the sync pulses are negative. If the modulation is negative, sync pulses are positive. The edges of the sync pulses are used for triggering, therefore incorrect polarity setting causes a sporadic triggering by the video information.

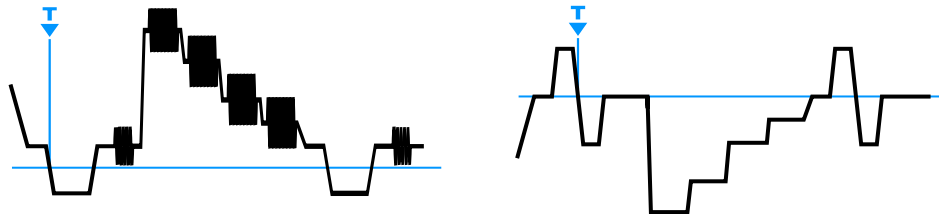

Figure 5-6: Positive video signal with negative bi-level sync pulse (SDTV, left) and negative signal with positive tri-level sync pulse (HDTV, right)

Remote command:

[TRIGger:A:TV:POLarity](#) on page 443

Mode

Selects from the following the trigger conditions:

- "All Frames" The oscilloscope triggers on the beginning of all video signal frames.
- "Odd Frames" The oscilloscope triggers on the beginning of video signal frames with an odd frame number.
- "Even Frames" The oscilloscope triggers on the beginning of video signal frames with an even frame number.
- "All Lines" The oscilloscope triggers on the beginning of all video signal lines.
- "Line Number" Triggers on an exact "Line" number.

Remote command:

[TRIGger:A:TV:FIELD](#) on page 444

Line

Sets an exact line number if "Mode" is "Line Number". The oscilloscope triggers exactly on the beginning of the selected line in any field.

Remote command:

[TRIGger:A:TV:LINE](#) on page 444

5.8 Pattern Trigger

The pattern trigger is a logic trigger. It provides any logical combination of the input channels and supports you in verifying the operation of digital logic. Additionally, you can set a time limitation to the pattern. Thus you can also trigger on bus patterns of parallel buses.

The channel pattern is configured in the "Logic Editor" dialog box.

► [Trigger] > "Trigger Type" = "Pattern" > "Edit Pattern"

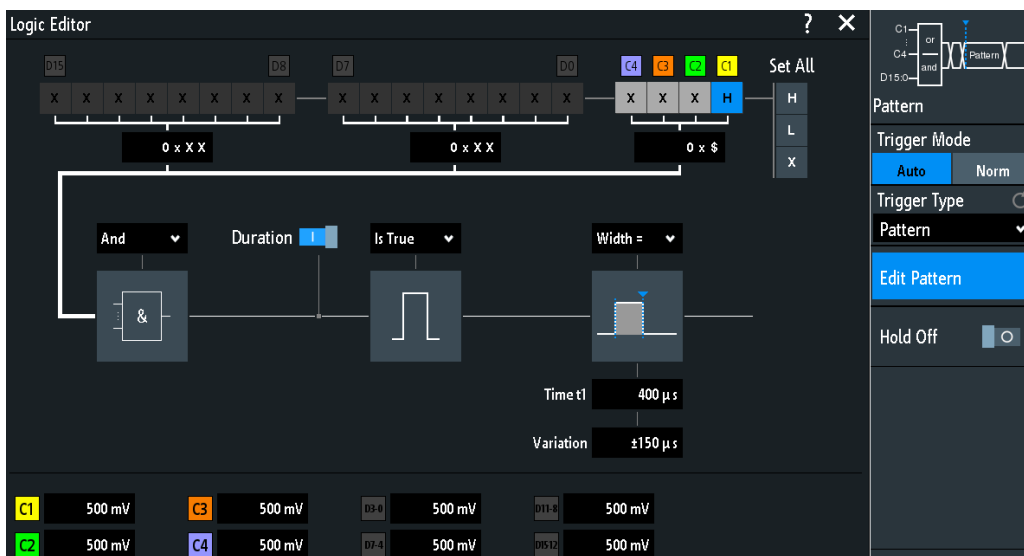

Figure 5-7: Pattern trigger with logic editor

Thresholds

At the bottom of the "Logic Editor", you see the current threshold settings of all channels. Here, you can directly activate the channels, and change the threshold values.

The thresholds of analog channels are also set in the "Channel <n>" > "Threshold" menu, see also [Chapter 4.3.6, "Threshold Settings"](#), on page 60.

The thresholds of logic channels are also set in the [Logic] > "Threshold and Deskew" dialog, see [Chapter 14.2, "Logic Analyzer Settings"](#), on page 374.

Logic settings

H | L | X, Set All..... 85

And | Or..... 86

Duration..... 86

True | False..... 86

Time limitation..... 86

H | L | X, Set All

Defines the pattern by selecting the state "H" (high), "L" (low) or "X" (do not care) for each active analog and digital channel.

The word length of the pattern depends on the number of available analog and digital channels.

Analog channels: 2 bit for 2-channel instruments, 4 bit for 4-channel instruments.

Digital (16 bit): the logic channels D0, D1,...,D15 are only available with MSO option R&S RTM-B1.

Thus the pattern can have 2, 4, 18, or 20 bits.

Use "Set All" to set all channels to the same state.

Remote command:

[TRIGger:A:PATtern:SOURce](#) on page 445

And | Or

Sets the logical combination of the channel states.

"AND" All defined states must be true.

"OR" At least one of the defined states must be true.

Remote command:

[TRIGger:A:PATtern:FUNCTion](#) on page 445

Duration

The switch has the following two effects:

- Selects the mode of the [True | False](#) comparison.
- Enables or disables the [Time limitation](#).

True | False

Defines whether the instrument triggers on fulfillment of the logical condition, or on violation.

- If [Duration](#) = on, the instrument triggers when the logic combination "Is True" or "Is False" for a specified time duration.
- If [Duration](#) = off, the instrument triggers when the logic combination is found in the signal ("Goes True"), or if it disappears ("Goes False").

Remote command:

[TRIGger:A:PATtern:CONDition](#) on page 445

Time limitation

To set a time limitation for the pattern, you have several possibilities. They are similar to the setting of a pulse width, see [Chapter 5.6, "Width Trigger"](#), on page 79.

- "Timeout" and "Time t"
Define a minimum time during which the signals match the pattern condition.
- "Width >" or "Width <" and "Time t"
Triggers if the pattern condition changes before or after the specified time.
- "Width =", "Time t1" and "Variation"
Triggers if the pattern condition is fulfilled for a duration "Time t1" ± "Variation".
- "Width ≠", "Time t1" and "Variation"
Triggers if the pattern condition is fulfilled for a duration shorter than "Time t1" - "Variation", or longer than "Time t1" + "Variation".
- "Inside", "Time t1" and "Time t2"
Triggers if the pattern condition is fulfilled for a duration between "Time t1" and "Time t2". These settings are an alternative setting to the definition with "Width =". The time values are interdependent and adjusted accordingly.
- "Outside", "Time t1" and "Time t2"
Triggers if the pattern condition is fulfilled for a duration shorter than "Time t1", or longer than "Time t2". These settings are an alternative setting to the definition with "Width ≠". The time values are interdependent and adjusted accordingly.

Remote command:

TRIGger:A:PATtern:MODE on page 446

TRIGger:A:PATtern:WIDTh:RANGe on page 446

TRIGger:A:PATtern:WIDTh[:WIDTh] on page 446

TRIGger:A:PATtern:WIDTh:DELTA on page 447

5.9 Runt Trigger

A runt is a pulse lower than normal in amplitude. The amplitude crosses the first threshold twice in succession without crossing the second one. For example, this trigger can detect logic, digital, and analog signals remaining below a specified threshold amplitude because I/O ports are in undefined state.

► [Trigger] > "Trigger Type" = "Runt"

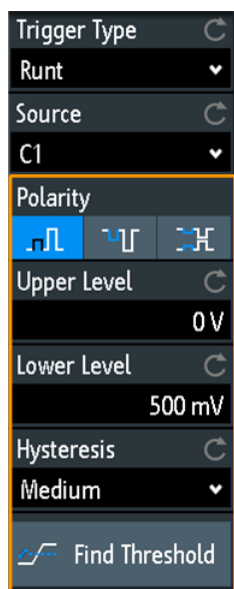

Polarity.....	87
Upper Level.....	88
Lower Level.....	88
Hysteresis.....	88
Find Threshold.....	88

Polarity

Sets the polarity of a pulse, that is the direction of the first pulse slope.

- positive going pulse, the width is defined from the rising to the falling slopes.
- negative going pulse, the width is defined from the falling to the rising slopes.
- selects both positive and negative going pulses.

Remote command:

TRIGger:A:RUNT:POLarity on page 448

Upper Level

Sets the upper voltage threshold for runt detection. A negative runt crosses the upper level twice without crossing the lower level.

Remote command:

`TRIGger:A:LEVel<n>:RUNT:UPPer` on page 447

Lower Level

Sets the lower voltage threshold for runt detection. A positive runt crosses the lower level twice without crossing the upper level.

Remote command:

`TRIGger:A:LEVel<n>:RUNT:LOWer` on page 447

Hysteresis

Hysteresis of the trigger source channel, see "[Hysteresis](#)" on page 61.

Remote command:

`CHANnel<m>:THReshold:HYSTeresis` on page 422

Find Threshold

The instrument analyzes the signal and sets the upper and lower trigger levels. If no level can be found, the existing values remain unchanged, and you can set the thresholds manually.

5.10 Rise Time Trigger

The rise time trigger, also known as slew rate or transition trigger, can detect fast or slow rising or falling edges selectively. It triggers on edges, if the rise or fall time from the lower to higher voltage level (or vice versa) is shorter or longer as defined, or inside or outside a specified time range. The trigger finds slew rates that are faster than expected or permissible to avoid overshooting and other interfering effects. It also detects very slow edges violating the timing in pulse series.

► `[Trigger] > "Trigger Type" = "Risetime"`



Polarity..... 89

Comparison..... 89

Rise Time..... 90

Variation..... 90

Upper Level..... 90

Lower Level..... 90

Hysteresis..... 90

Find Threshold..... 90

Polarity

Sets the edge, the transition time of which is to be analyzed:

- rise time trigger
- fall time trigger
- rise and fall time trigger

Remote command:

[TRIGger:A:RISetime:SLOPe](#) on page 449

Comparison

Selects how the time limit for the slew rate is defined. The time measurement starts when the signal crosses the first trigger level - the upper or lower level depending on the selected slope - and stops when the signal crosses the second level.

"Greater than" Triggers on transition times longer than the given "Rise Time".

"Lower than" Triggers on transition times shorter than the given "Rise Time".

- "Equal" Triggers on transition times inside the time range *Rise Time ± Variation*.
- "Not equal" Triggers on transition times outside the time range *Rise Time ± Variation*.

Remote command:

[TRIGger:A:RISetime:RANGe](#) on page 449

Rise Time

Sets the reference rise time, the nominal value for comparisons.

Remote command:

[TRIGger:A:RISetime:TIME](#) on page 450

Variation

Defines a time range around the given "Rise Time" value.

Remote command:

[TRIGger:A:RUNT:DELTA](#) on page 447

Upper Level

Sets the upper voltage threshold. When the signal crosses this level, the slew rate measurement starts or stops depending on the selected polarity.

Remote command:

[TRIGger:A:LEVel<n>:RISetime:UPPer](#) on page 449

Lower Level

Sets the lower voltage threshold. When the signal crosses this level, the slew rate measurement starts or stops depending on the selected slope.

The value corresponds to the threshold value of the trigger channel.

Remote command:

[TRIGger:A:LEVel<n>:RISetime:LOWer](#) on page 448

Hysteresis

Hysteresis of the trigger source channel, see "[Hysteresis](#)" on page 61.

Remote command:

[CHANnel<m>:THReshold:HYSTeresis](#) on page 422

Find Threshold

See "[Find Threshold](#)" on page 88.

5.11 Timeout Trigger

The timeout trigger checks if the signal stays above or below the threshold voltage for a specified time lapse. In other words, the trigger occurs if the trigger source signal does not cross the threshold during the specified time.

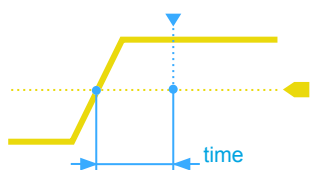

Figure 5-8: Timeout trigger with range Stays High

► [Trigger] > "Trigger Type" = "Timeout"



Figure 5-9: Timeout trigger menu

Range

Selects the relation of the signal level to the threshold:

Stays High The signal level stays above the trigger level.

Stays Low The signal level stays below the trigger level.

Remote command:

[TRIGger:A:TIMEout:RANGe](#) on page 450

Time

Defines the time limit for the timeout at which the instrument triggers.

Remote command:

[TRIGger:A:TIMEout:TIME](#) on page 450

Threshold

Threshold of the trigger source channel, used as trigger level for the timeout trigger.

See also "[Threshold](#)" on page 61 and "[Trigger Level, Threshold](#)" on page 77.

Remote command:

[TRIGger:A:LEVel<n>\[:VALue\]](#) on page 438

[CHANnel<m>:THReshold](#) on page 421

Hysteresis

Hysteresis of the trigger source channel, see ["Hysteresis"](#) on page 61.

Remote command:

[CHANnel<m>:THReshold:HYSteresis](#) on page 422

5.12 Trigger Out Signal

The R&S RTM3000 can output a pulse at the Aux Out connector when the instrument triggers.

1. To output a pulse at a trigger event, configure the Aux Out connector: "Setup" menu > "Aux Out" > "Trigger Out".
See also: ["Aux Out"](#) on page 209.
2. Using remote commands, you can set the pulse width and polarity of the trigger out pulse. The commands are described in [Chapter 16.10.5, "Trigger Out"](#), on page 572.

6 Waveform Analysis

• Zoom	93
• Mathematics	97
• Reference Waveforms	107
• History and Segmented Memory (Option R&S RTM-K15)	112
• Search	121

6.1 Zoom

The zoom magnifies a part of the waveform to view more details. The zoom is applied to all active analog and digital channels and math waveforms.

The following zoom types are available:

- Horizontal zoom: the waveforms are displayed with a shorter time scale while the vertical scale remains unchanged.
- Vertical zoom: the zoom waveforms are enlarged in vertical and horizontal direction.

6.1.1 Zooming In

When you activate the zoom, two windows are displayed: the original waveform diagram at the top, and the zoom window at the bottom.

If zoom is active, the time scale of the original waveform diagram is at least 40 ns/div. When you activate the zoom at a smaller time scale, the instrument changes the time scale to the minimum value.

- ▶ To activate the horizontal zoom, press the [Zoom] key.
- ▶ To activate the vertical zoom:
 - a) Tap the "Zoom" icon on the toolbar.
 - b) Drag your finger on the screen to draw the diagonal of the zoom area. You can draw the zoom area on the original waveform, or on an existing zoom waveform. A rectangle indicates the zoom area.

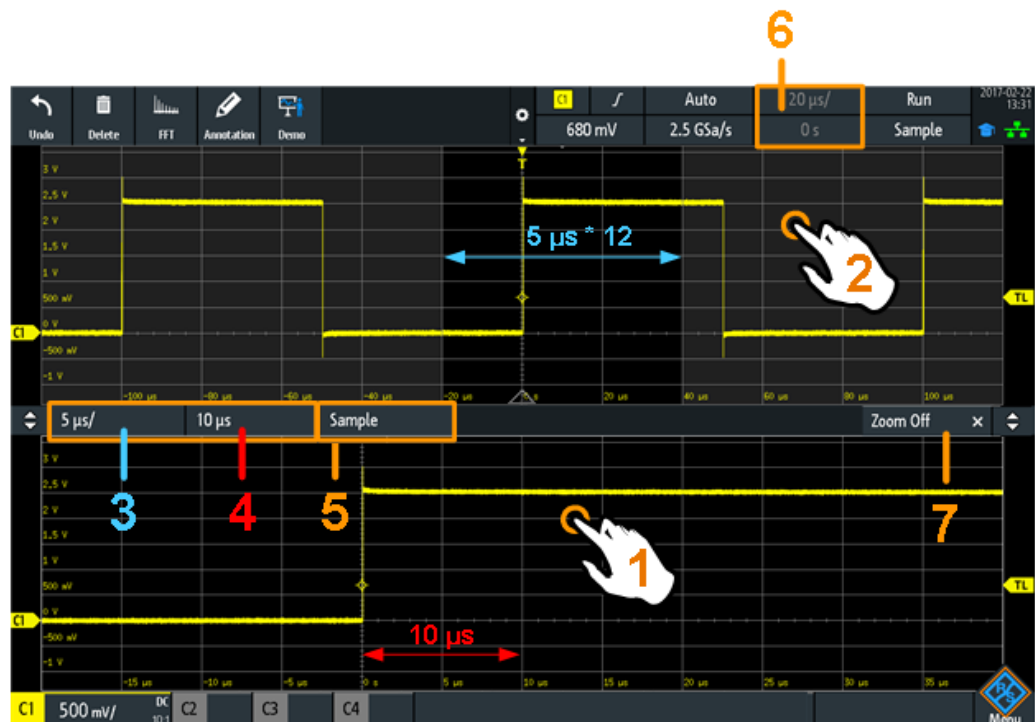

Figure 6-1: Display of horizontal zoom: zoom in bottom window, normal waveform in upper window

- 1 = Tap to activate zoom settings
- 2 = Tap to activate normal waveform settings
- 3 (blue) = Horizontal zoom scale and width of the zoom area
- 4 (red) = Horizontal zoom position
- 5 = Acquire mode, can be set in zoom window or in the upper status bar
- 6 = Horizontal scale and position of the normal waveform
- 7 = Close zoom window



Figure 6-2: Display of vertical zoom

6.1.2 Modifying the Zoom

There are several ways to adjust the zoom:

- Use finger gestures on the screen.
- Use the [Scale] and [Position] knobs.
- Tap the zoom scale or zoom position label in the zoom window and enter a value on the keypad. These settings are horizontal values, which take effect in horizontal and vertical zoom windows. See number 3 and 4 in [Figure 6-1](#).
- Use the menu to enter exact numerical values. See [Chapter 6.1.3, "Zoom Settings"](#), on page 96.

To adjust the zoom using gestures

1. For horizontal and vertical zoom:
 - a) To change the horizontal zoom position, drag one finger horizontally in the zoom window.
 - b) To change the horizontal zoom scale and width of the zoom area, spread or pinch two fingers in horizontal direction.
2. For vertical zoom only:
 - a) To change the vertical zoom position, drag one finger vertically in the zoom window.
 - b) To change the vertical zoom scale and height of the zoom area, spread or pinch two fingers in vertical direction.
3. To change the position of the zoom area in vertical zoom:

Drag the zoom area on the original waveform in the upper window.

To adjust the zoom using the horizontal rotary knobs

1. To set the focus to the zoom window (lower window), tap in the zoom window.
2. For horizontal and vertical zoom:
 - a) To change the horizontal zoom scale and width of the zoom area, turn the horizontal [Scale] scale knob.
 - b) To change the horizontal zoom position, turn the horizontal [Position] knob.
3. For vertical zoom only:
 - a) To change the vertical zoom scale and height of the zoom area, turn the vertical [Scale] scale knob.
 - b) To change the vertical zoom position, turn the [Offset/Position] knob (upper knob in Vertical section).
4. To set the focus to the normal waveform, tap the upper window.
Now the knobs are applied to the normal waveform and adjust time scale and horizontal position of the waveform.

6.1.3 Zoom Settings

Zoom settings are listed in the "Horizontal" menu if the zoom is active.

1. If the zoom is off, activate the zoom.
2. Press the [Horizontal] key.

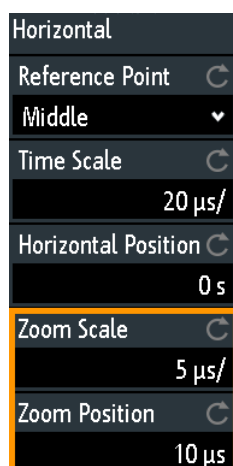

Zoom Scale

Defines the horizontal scale for the zoom window in seconds per division. The scaling determines the width of the zoom area (12 divisions * scaling per division), the time-base of the zoom window. The zoom area is indicated in the original waveform window.

"Zoom Scale" has effect only in horizontal zoom.

Remote command:

`TIMEbase:ZOOM:SCALE` on page 451

Zoom Position

Defines the distance of the trigger point to the reference point in the zoom window. The value determines the position of the zoom area in the upper window.

"Zoom Position" has effect in horizontal and vertical zoom.

Remote command:

`TIMEbase:ZOOM:TIME` on page 451

6.2 Mathematics

A math waveform is a calculated waveform. It is calculated out of one or two analog channels, a constant, or another math waveform using several predefined operations. You can define up to 5 equations. The complete configuration is called equation set and can be saved for later use.

You can analyze math waveforms in the same way as channel waveforms: use zoom, perform automatic and cursor measurements, and save as reference waveform.

When the instrument is in roll mode, some math functions are non-calculable, and the math waveform label indicates "Not Available".

6.2.1 Short Menu for Math Waveforms

The math waveform label at the bottom of the screen shows the main settings of the math waveform: sources, operation, unit, and vertical scale. The short menu shows the status of all math waveforms.

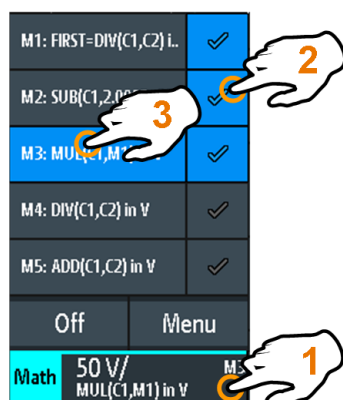

- 1 = open short menu
- 2 = display a math waveform
- 3 = select a math waveform for scaling and positioning
- Menu = open the "Mathematics" menu and "Equation Set Editor"
- Off = disable mathematics

6.2.2 Configuring Math Waveforms

1. Press the [Math] key.
The math waveforms are activated, using the latest settings.
2. Press the [Math] key again.
The "Mathematics" menu and the "Equation Set Editor" are shown.
3. Configure the equations of the math waveforms in the "Equation Set Editor". You can define up to 5 equations. The complete configuration is called equation set and can be saved for later use.
 - a) Tap the row of the math waveform that you want to configure.
 - b) To activate the math waveform, set its "State".
 - c) Select the "Operation".
 - d) Select the "Source(s)", the operands of the mathematical equation: 1 or 2 analog channels, constant values or math waveforms. Only math waveforms of lower order are available, for example, M2 can be a source for M3, M4, and M5. For M1, math waveform sources are not available.
 - e) Select the "Unit".
 - f) Optionally, add label to the math waveform. The label is shown at the right edge of the grid.
4. Close the "Equation Set Editor".
5. To adjust vertical scale and position using vertical knobs:
 - a) Select a math waveform in the short menu.
 - b) Use the rotary knobs in the Vertical section of the front panel. See: [Chapter 4.3.1, "VERTICAL Controls"](#), on page 45.
6. To enter exact values for vertical scale and position:
 - a) Open the "Mathematics" menu.
 - b) In the "Equation Set Editor", select a math waveform.
 - c) In the menu, enter "Vertical Scale" and "Position".

6.2.3 Settings for Math Waveforms

In the "Mathematics" menu, you find the general settings for math waveforms. You can:

- Switch mathematics on and off.
- Save configured equations in an equations set file, see [Chapter 6.2.7, "Saving and Loading Formularies"](#), on page 107.
- Load a previously saved equation set.
- Adjust the display of the math waveform that is selected in the "Equation Set Editor":
 - Vertical position
 - Vertical scale

- Waveform color

Remote commands:

- `CALCulate:MATH<m>:STATE` on page 453
- `CALCulate:MATH<m>:POSITION` on page 455
- `CALCulate:MATH<m>:SCALE` on page 455
- `CALCulate:MATH<m>:WCOLor` on page 455
- Waveform transfer: see [Chapter 16.9.1.3, "Math Waveforms"](#), on page 544
- History data: see [Chapter 16.6.5.2, "Displaying History Segments"](#), on page 479 and [Chapter 16.6.5.3, "Timestamps"](#), on page 482

6.2.4 Mathematic Functions

When you open the "Mathematics" menu, the "Equation Set Editor" opens in parallel.

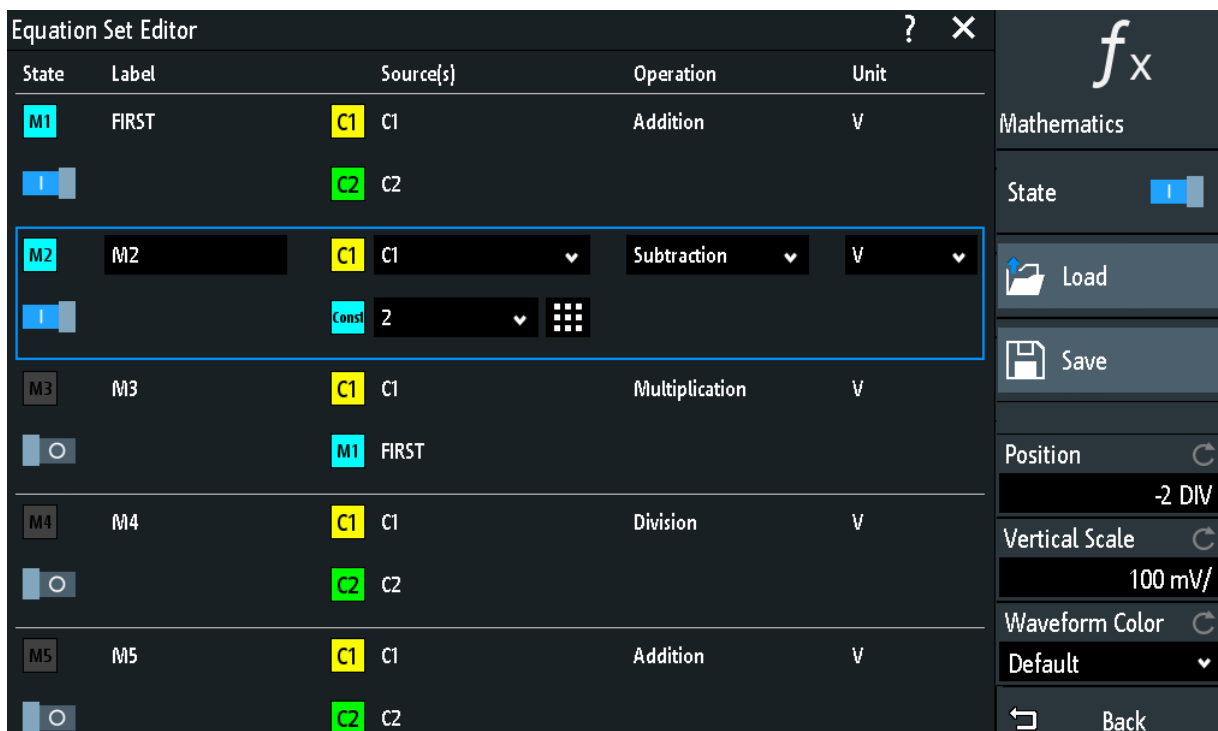

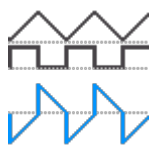

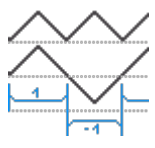
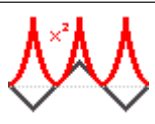
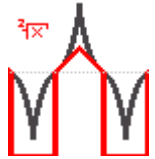
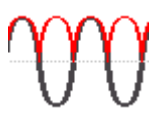
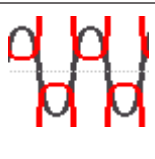



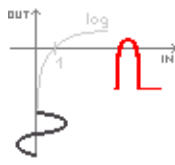
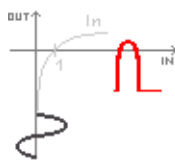
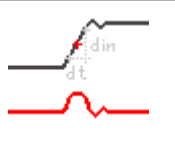

Figure 6-3: Mathematics menu and Equation Set Editor

The "Mathematics" menu is described in [Chapter 6.2.3, "Settings for Math Waveforms"](#), on page 98.

In the "Equation Set Editor", you configure up to 5 math waveforms, set their visibility, and define a label for each waveform. Each equation consists of one or two operands and an operator. An operand (source) can be an input channel, a constant value, or a math waveform with lower number.

The following operations are available:

Addition		<p>Source1 + Source2</p> <p>Adds the values of 2 sources (channel or math waveform, or constant).</p>
Subtraction		<p>Source1 - Source2</p> <p>Subtracts the second source from the first source.</p>
Multiplication		<p>Source1 * Source2</p> <p>Multiplies the two sources.</p>
Division		<p>Source1 / Source2</p> <p>Divides the first source by the second source.</p> <p>For small amplitudes of the second source, the result increases quickly. If the second source crosses zero, the result would be a range of $+\infty$ to $-\infty$. In this case, instead of 0 V, the calculation function uses the value that the Least Significant Bit (LSB) of the second source represents. (For an 8-bit value, for example, 1/256).</p>
Square		<p>Source1 * Source1</p> <p>Squares the source. If the source contains negative values that have been clipped, then the result contains positive clipping.</p>
Square Root		<p>Square Root (Source)</p> <p>Calculates the square root of the source. Note that the square root of a negative number is undefined and the result is clipped.</p>
Abs. Value		<p> Source </p> <p>Calculates the absolute value of the source. All negative values are inverted to positive values. The positive values remain unmodified. If the source has negative values that have been clipped, the result contains positive clipping.</p>
Reciprocal		<p>1V / Source</p> <p>Divides 1V by the source values.</p> <p>For small source amplitudes the result increases quickly. If the source crosses zero, the result would be a range of $+\infty$ to $-\infty$. In this case, instead of 0 V, the calculation function uses the value that the Least Significant Bit (LSB) of the operand represents. (For an 8-bit value, for example, 1/256).</p>
Inverse		<p>Inverts all voltage values of the source, i.e. all values are mirrored at the ground level. Thus, a positive voltage offset becomes negative. If the amplitude of the source is clipped, the result is the inverted limitation.</p>

Common Log.		log(Source) Calculates the logarithm to the basis 10 of the source. Note that the logarithm of a negative number is undefined and the result is clipped.
Natural Log.		ln(Source) Calculates the logarithm to the basis e (Euler number) of the source. Note that the logarithm of a negative number is undefined and the result is clipped.
Derivative		f'(Source) The derivative corresponds to the rise of the tangent through a function point and indicates the dimension of the change in quantity of the source in time. The larger the quantity change of the operand per time becomes, the larger the result of the derivative is. The calculation is approximated using the secant based on the current calculated value and a value with a distance of 0.1 DIV. Due to this, the time axis has a finitely small resolution. Therefore, scale the input signal to display the required area appropriately.
Integral		Calculates the definite integral of the source. The calculation is displayed in the illustration. The integration starts at point "a" and adds the area beneath the waveform. Point "b" indicates the currently calculated value. At the end of the positive alternation, the integral function reaches its maximum. Due to the homopolar operand used in this example, the waveform of the area reaches zero after the negative alternation. Use a "V-Marker" cursor to measure the area for an extract of the waveform.
Low pass High pass		Low pass filter and high pass filter, see Chapter 6.2.5, "Filters" , on page 101.
Track ...		Track functions, see Chapter 6.2.6, "Tracks" , on page 102.

Remote command:

- `CALCulate:MATH<m>[:EXPRession][:DEFine]` on page 453
- `CALCulate:MATH<m>:LABel` on page 454
- `CALCulate:MATH<m>:LABel:STATe` on page 454

6.2.5 Filters

The R&S RTM3000 provides several ways to filter the input signal:

- Lowpass filter by selecting a bandwidth limit in the acquisition path (vertical channel settings), see [Chapter 4.3.3, "Vertical Settings"](#), on page 47.
- Create a filtered math waveform (lowpass or highpass). Filtered math waveforms are described below.

To create a lowpass or highpass, the infinite impulse response filter (IIR) is used. The filter require an additional setting: the cut-off frequency "BW".

Table 6-1: Available math filters

Low pass	LP(Source,BW) Calculates a low-pass filtered waveform of the source waveform using 2nd order IIR. The cut-off frequency BW is set as a const value. Signal components with frequencies higher than the cut-off frequency are attenuated significantly.
High pass	HP(Source,BW) Calculates a high-pass filtered waveform of the source waveform using 1st order IIR. The cut-off frequency BW is set as a constant value. Signal components with frequencies below the cut-off frequency are attenuated significantly.

IIR filter need a settling time. During settling time, the filtered waveform is not shown on the screen, thus the filtered waveform is shorter than the source waveform. The duration of the settling time depends on the cut-off frequency "BW". The lower the limit, the longer the settling time, an the shorter the filtered waveform.

The cut-off frequency is limited and depends on the horizontal resolution of the display data. If the selected cut-off frequency exceeds the limit, the limit frequency is shown in red in the math waveform label.



6.2.6 Tracks

The track is a waveform that shows measurement values in time-correlation to the measured signal. It is the graphical interpretation of measurement values of a single acquisition. The R&S RTM3000 can track frequency, period, pulse width, and duty cycle of pulse width modulated waveforms (PWM) and pulse density modulated waveforms (PDM). Math tracks are independent of the measurement functions.

Tracks are used, for example, in power analysis, or for analysis of motor controls, which use PWM signals to control speed. PDM signals are used, for example, for model flight control.

Bipolar signals have negative and positive pulses. Bipolar PWM signals are used, for example, to change the direction of the motor, and can be measured using differential probes.

Table 6-2: Available track waveforms

Track period	TPER(Source) in s Tracks the period values of the source waveform, the time between the crossing points of two subsequent on or off edges with the threshold. See Figure 6-7 .
Track period (bipolar)	TPERB(Source) in s Tracks the period values of a bipolar source waveform. See Figure 6-6 .
Track frequency	TFREQ(Source) in Hz Tracks the frequency values of the source waveform.

Track frequency (bipolar)	TFREQB(Source) in Hz Tracks the frequency values of a bipolar source waveform.
Track pulse width	TPW(Source) in s Tracks the pulse width of the source waveform. For a PWM source signal, the result is the demodulated waveform. See Figure 6-5 .
Track pulse width (bipolar)	TPWB(Source) in s Tracks the pulse width of a bipolar source waveform. For a PWM source signal, the result is the demodulated waveform. See Figure 6-8 .
Track duty cycle	TDCY(Source) in % Tracks the duty cycle of the source waveform. For a PWM source signal, the result is the demodulated waveform. See Figure 6-4 .
Track duty cycle (bipolar)	TDCYB(Source) in % Tracks the duty cycle of a bipolar source waveform. For a PWM source signal, the result is the demodulated waveform. See Figure 6-6 .

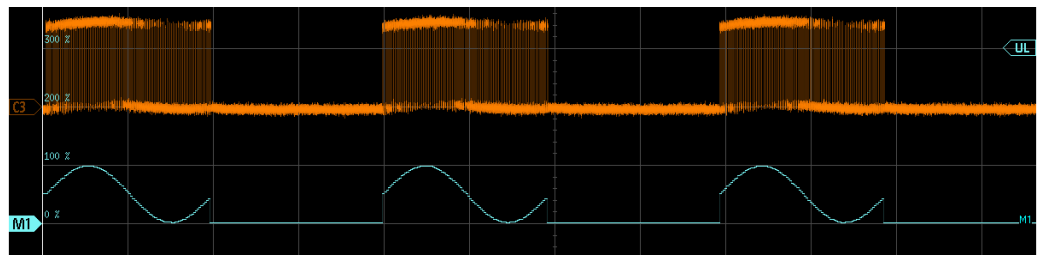

Figure 6-4: Unipolar PWM signal with duty cycle track M1, which is the demodulated waveform

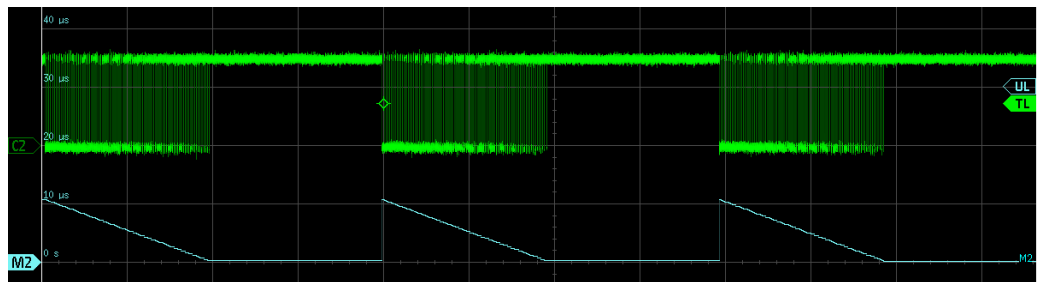

Figure 6-5: Unipolar PWM signal with pulse width track M2

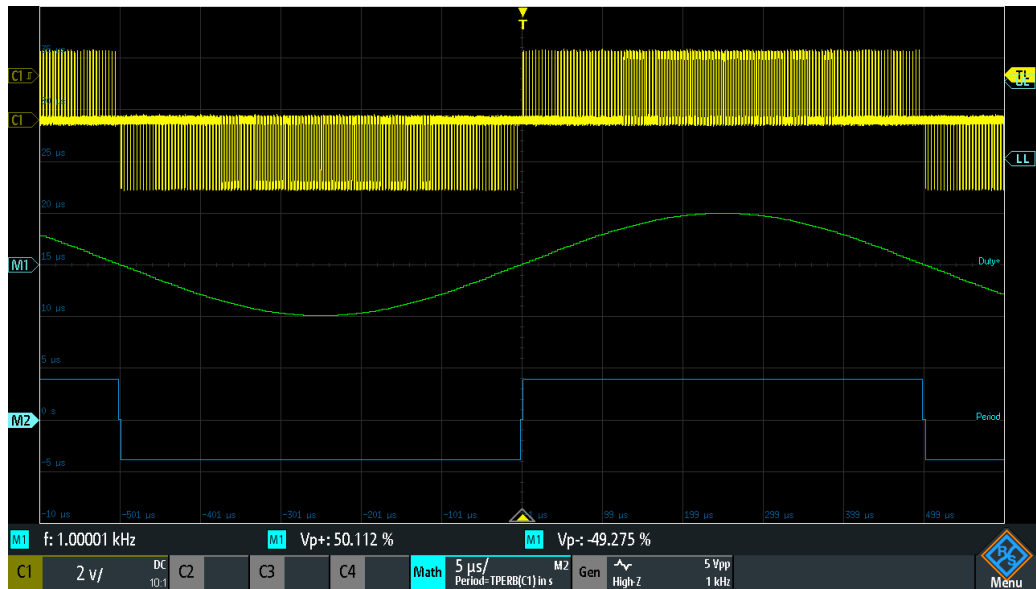

Figure 6-6: Bipolar PWM waveform with duty cycle track M1 in green and period track M2 in blue

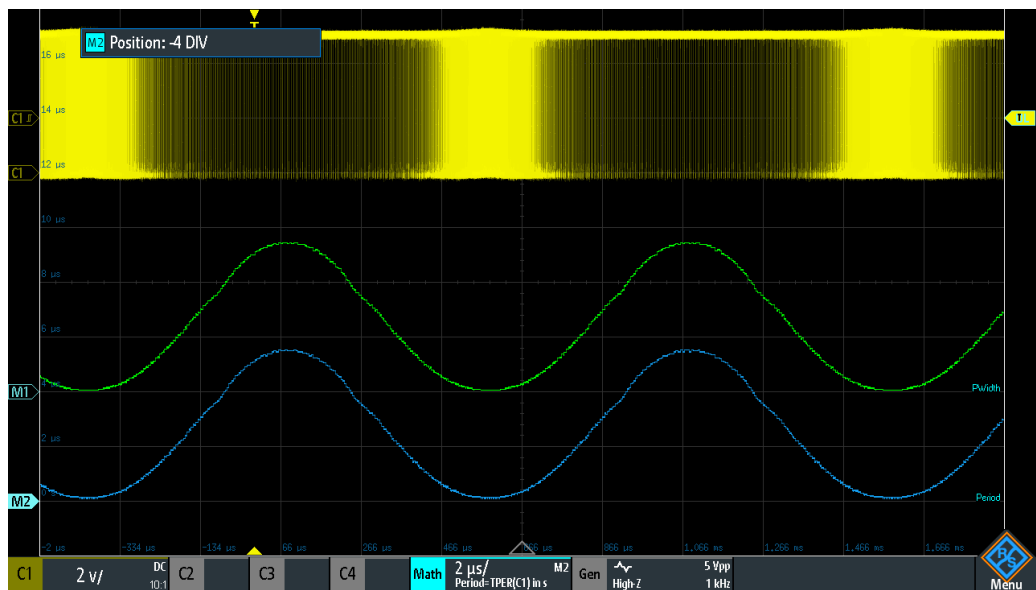

Figure 6-7: Unipolar PDM waveform with pulse width track M1 in green and period track M2 in blue

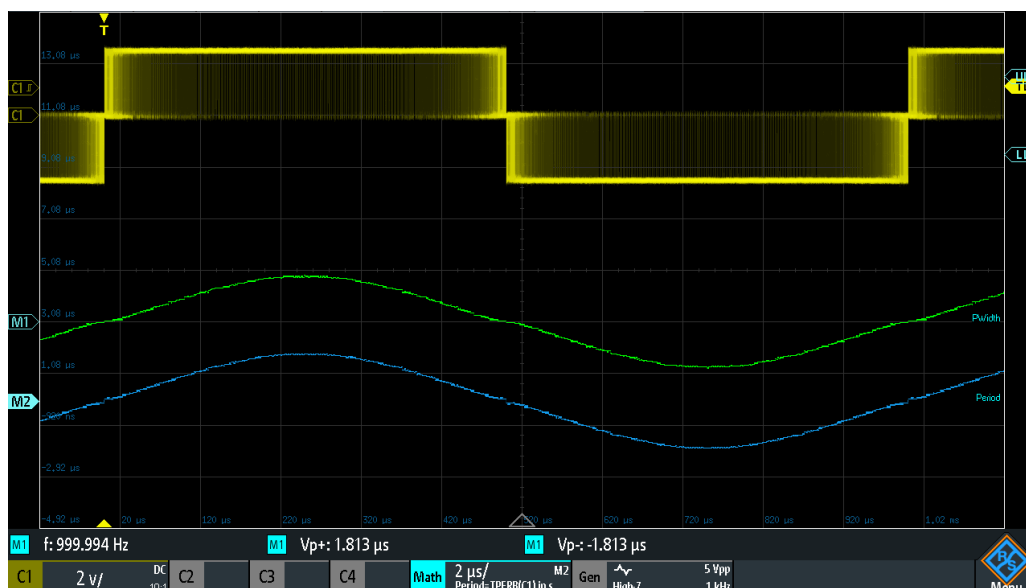

Figure 6-8: Bipolar PDM signal with pulse width track M1 in green and period track M2 in blue. For PDM waveforms, pulse width and period are synchronous.

6.2.6.1 Settings for Tracks

The determination of track values requires one threshold for unipolar PWM signals, and two thresholds for bipolar PWM signals. When the pulse crosses the threshold, the pulse width is measured and displayed as track value. To detect the real transitions of the pulse signal, the hysteresis is used. The unit is set automatically.

State	Label	Source(s)	Operation	Unit
M1	M1	C1	Track Period	s
I		UL: 1.5 V	Hyst: 500 mV	Edge: On
M2	M2	C2	Track Duty Cycle Bipolar	%
I		UL: 1.5 V LL: 1 V	Hyst: 200 mV	Edge: On

UL

Sets the threshold for unipolar track sources, or the upper level for bipolar sources. The signal is measured at the crossing points of the signal with the threshold.

Remote command:

`CALCulate:MATH<m>:TRACk:THReshold[:UPPer]` on page 456

LL

Sets the lower level for bipolar track sources, which determines the crossing points on negative pulses.

Remote command:

`CALCulate:MATH<m>:TRACk:THReshold:LOWer` on page 456

Hyst

Sets the hysteresis for correct edge detection.

Remote command:

[CALCulate:MATH<m>:TRACk:THReshold:HYSTeresis](#) on page 456

Edge

Sets the rising or falling edge as a reference for each measurement. The setting helps to determine values in terms of the power stage switching state.

For unipolar sources, the on edge is the rising edge, and the off edge is the falling edge.

In the bipolar case, all transitions are inverted for the negative branch. For positive pulses, the rising edge is the on edge, and for negative pulses, the falling edge is the on edge. You can also subtract out the effect of the double pulse, which arises due to the inversion: select "On, Double Pulse" or "Off, Double Pulse"

Remote command:

[CALCulate:MATH<m>:TRACk:EDGE](#) on page 455

[CALCulate:MATH<m>:TRACk:DPULse\[:ENABLE\]](#) on page 456

6.2.6.2 Demo for Tracks

Short demo tutorials explain PWM signals and the track function.

To show a demo:

1. Press the  [Apps Selection] key.
2. Select the "Applications" tab.
3. Select "Demo".
4. Select the "Track" tab.
5. Select the signal.
6. Connect the demo signal to the input channel as shown in the wizard.
7. Tap "Start".

6.2.6.3 Example Signals for Tracks

If the signal generation option R&S RTM-B6 is installed, you can use the pattern generator to generate PWM signals, see [Chapter 15.2.7, "Settings for PWM Signals"](#), on page 401.

To get familiar with track functions, the R&S RTM3000 provides several pre-configured PWM, PDM and motor control signals with track waveforms.

To display an example signal:

1. Press the  [Apps Selection] key.
2. Select the "Track" tab.

3. Select the signal.
4. Connect the input channels. The required connection is shown in the upper left corner of the display.

Signal	Connect source...	With input channel...
PWM Unipolar	"Gen" generator output	"Ch1"
PWM Bipolar	"Gen" generator output	"Ch1"
PDM Unipolar	"Gen" generator output	"Ch1"
PDM Bipolar	"Gen" generator output	"Ch1"
Inverter	"Gen" generator output	"Ch1"
DC Motor	"Gen" generator output	"Ch1"
3 Phase Motor	Pattern Generator: P0, P1, P2	"Ch1", "Ch2", "Ch3"
PWM - RGB LED	Pattern Generator: P0, P1, P2	"Ch1", "Ch2", "Ch3"

The track of the bipolar inverter signal shows the real sinus waveform, which considers the double pulse arising from the inversion. This sinus track can be compared with the ideal control signal.

6.2.7 Saving and Loading Formularies

You can save equation sets with up to 5 formularies in the internal storage of the instrument, or to USB flash drive, and load them later. Furthermore, you can move or copy saved equation sets from internal storage to USB flash drive, and vice versa, see [Chapter 9.6, "Export and Import"](#), on page 206.

To save an equation set

1. In the "Mathematics" menu, tap "Save".
2. Select the "Destination": internal storage or USB, and the directory.
The destination `/USB_FRONT` is only active, if a USB flash drive is connected to the front USB port.
3. Enter the filename.
4. Optionally, enter a comment.
5. Tap "Save".

6.3 Reference Waveforms

To compare waveforms and analyze differences between them, you can display reference waveforms.

Reference waveforms are waveform data stored in the internal reference storages. Four reference waveforms are available and can be displayed: R1 to R4.

The display of a reference waveform is independent from the display of the source waveform; you can change the vertical and also horizontal scales and positions. The current scale values are shown in the waveform label of the reference waveform.

Short menu

The short menu shows the status of all reference waveforms.

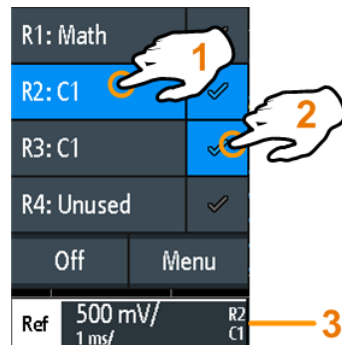

1 = select a reference waveform

2 = display a reference waveform

3 = Reference waveform label with vertical and horizontal scale, reference number and source waveform

File format

Waveforms can be saved as reference waveforms. The file format is TRF. Files can be saved to and loaded from internal memory or external USB flash device.

TRF is the specific binary format for reference waveforms of the R&S RTM3000. It contains the amplitude value of each sample that is displayed on the screen (8 bit or 16 bit long). For peak-detect waveforms, 2 values per sample are saved. The file contains also time information (time of the first sample and the sample interval) and current instrument settings.

The data can be loaded as reference waveform for further use on the instrument. It is not intended for analysis outside the R&S RTM3000.

6.3.1 Using References

To create and display a reference waveform

1. To activate the reference waveform and open the "References" menu, press the [Ref] key twice.
2. To create a reference waveform from an active waveform:
 - a) Select the "Source" waveform.
 - b) Select the target "Reference".
 - c) Tap "Copy"

The new reference waveform is created on top of its origin, and it has the focus.

3. To change the scaling and position, use the horizontal and vertical [Position] and [Scale] knobs.

See also:

- [Chapter 4.3.1, "VERTICAL Controls"](#), on page 45
- [Chapter 4.4.1, "HORIZONTAL Controls"](#), on page 63

To save a waveform as reference waveform

You can save any active waveform directly as reference waveform to a file.

1. To open the "References" menu, tap the  menu icon and select "References".
2. Tap "Save Reference".
3. Select the waveform that you want to save: "Source".
4. Tap "Destination".
5. Select the "Location" (internal or USB).
6. If you save the file on USB flash device, you can set a target folder.
 - a) Double-tap the target folder. If the folder does not exist, you can create a new one.

The folder opens.
 - b) Tap "Accept Dir." .
7. If necessary, change the "File Name".
8. Optionally, add a comment.
9. Tap "Save"
10. Close the dialog box.

To load a reference waveform

1. To open the "References" menu, tap the  menu icon and select "References".
2. Select the target "Reference" waveform.
3. Tap "Load Reference".
4. Select the "Location", the folder, and the reference file.
5. Tap "Load".

The instrument writes the waveform data to the selected reference waveform and displays it.

6.3.2 Settings for Reference Waveforms

- ▶ To open the "References" menu:

- a) Tap the  menu icon in the lower right corner of the screen.
- b) Scroll down. Select "References".

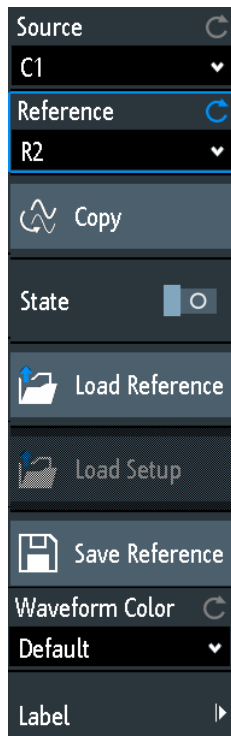

Source.....	110
Reference.....	110
Copy.....	111
State.....	111
Load Reference.....	111
Load Setup.....	111
Save Reference.....	111
Waveform Color.....	111
Label.....	112
L Bit.....	112
L Label.....	112
L Predefined Label.....	112
L Edit Label.....	112

Source

Defines the source of the reference waveform. Any active channel, math or reference waveform can be selected.

Remote command:

[REFCurve<m>: SOURce](#) on page 457

[REFCurve<m>: SOURce: CATalog?](#) on page 457

Reference

Selects one of the four possible reference waveforms.

Copy

Copies the "Source" waveform to the selected reference waveform. The reference waveform is kept until you update it or load another waveform to the reference.

Remote command:

[REFCurve<m>:UPDate](#) on page 458

State

Activates the reference waveform and displays it.

Remote command:

[REFCurve<m>:STATE](#) on page 458

Load Reference

Provides functions to load a reference waveform.

Select the "Location" of the waveform file (internal or USB), and the file. Tap "Load Reference".

You can also delete obsolete files in the dialog box.

Remote command:

[REFCurve<m>:LOAD](#) on page 458

Load Setup

Loads the device settings that were used to obtain the stored reference waveform. The settings are only available if the file was stored to the internal storage and never written to a USB flash device.

Load the reference waveform first, and then the settings. If settings were not stored, "Load Setup" is not active.

Remote command:

[REFCurve<m>:LOAD:STATE](#) on page 459

Save Reference

Opens a dialog box to save a waveform as reference waveform:

"Source"	Select the waveform to be saved. You can save any active analog channel, math or reference waveform, or logic pod.
"Destination"	Select the "Location" (internal directory or USB flash device), and the target directory.
"File Name"	Enter the filename. If a file with the same filename already exists in the destination directory, it will be overwritten without notification.
"Comment"	Optionally, enter text to describe the waveform.
"Save"	Saves the data.

Remote command:

[REFCurve<m>:SAVE](#) on page 458

Waveform Color

Selects a color for the reference waveform. The default color is white. You can select another monochrome color, or a color scale.

The color scales are described in "[Waveform Color](#)" on page 51.

Remote command:

[REFCurve<m>:WCOLor](#) on page 460

Label

Opens a menu to specify user-defined text labels for the individual reference waveforms.

Bit ← Label

Selects the reference waveform for labeling.

Label ← Label

Enables or disables the user-defined label for the selected reference waveform.

Predefined Label ← Label

Selects a predefined label text. You can edit the text with "Edit Label".

Edit Label ← Label

Opens on-screen keypad to enter a label text. If you previously have selected a predefined label, it is already written in the entry line, and you can modify it.

The maximum name length is 8 characters, and only ASCII characters provided on the on-screen keypad can be used.

Remote command:

[REFCurve<m>:LAbel](#) on page 460

6.4 History and Segmented Memory (Option R&S RTM-K15)

Using the history and segmented memory, you can access the data of previously acquired waveforms and analyze them. For example, you can analyze signals that occur in short bursts with long idle times, packet communication on serial buses, radar pulses, and laser pulses. The segmented memory is used to store the waveforms and provides a segment table to analyze the stored waveforms.

You can analyze history segments in the same way as the waveform of the latest acquisition. All R&S RTM3000 measurement and analysis tools are available: zoom, cursor measurements, quick and automatic measurements, mask test, serial protocol analysis, mixed-signal functions and so on.

The segment table and the waveform data of history segments can be saved to file.

The fast segmentation mode reduces the blind time of the acquisition.

6.4.1 Segmented Memory

If an acquisition runs, the instrument stores the captured data in the memory, processes the data and displays the waveform. The segmented memory keeps the data of the displayed waveform and also the data of the waveforms that have been captured

before. Each stored waveform is called a segment. The record length of the segments can be defined. The number of segments depends on the record length. The shorter the record length, the more segments can be saved.

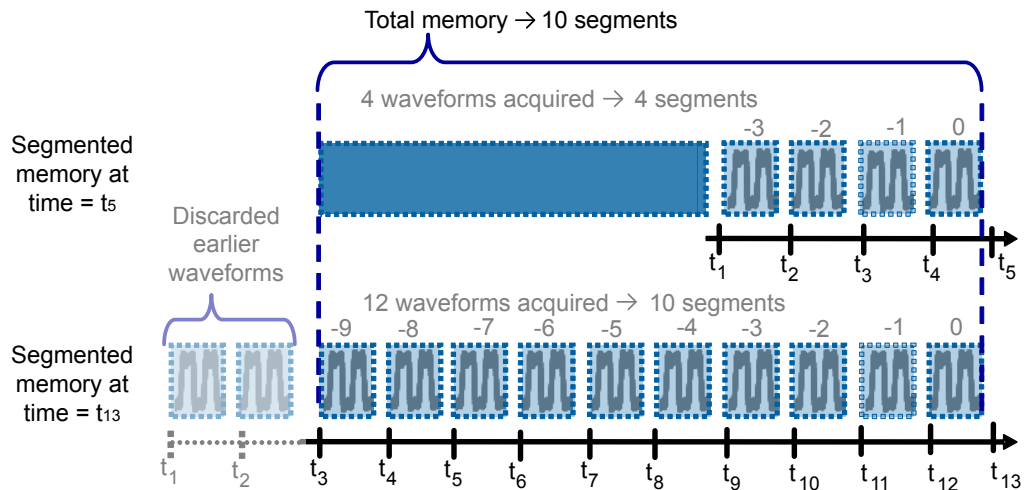

Figure 6-9: Segmented memory. In this example, the memory can store 10 segments.

Each segment has a timestamp time to identify when the events took place.

The history can access the stored segments and display them. When you start a new acquisition, the memory is cleared and the segments are written anew.

The history stores the following data during acquisition:

- All active analog channels.
- All logic channels if at least one logic is active (with option R&S RTM-B1).
- Decoded bus data if the bus is active (with at least one serial protocol option, for example, R&S RTM-K1 or -K2).

Fast segmentation

During normal acquisitions, only a short time of the acquisition cycle is used for sampling; processing and display take most of the time. The processing and display time is blind time causing a gap in the recorded signal. Usual acquisitions can miss very short-time and infrequent events occurring during the dead time.

To reduce the dead time and thus the probability of missed events, fast segmentation is provided.

With fast segmentation, subsequent triggered acquisitions are captured very fast, with hardly any dead time between the acquisitions. After the acquisition of all segments has been completed, the data is processed and the latest waveform is displayed. Using the history viewer, you can view and analyze all stored waveform segments.

6.4.2 Activating the History

To activate the history

1. Tap the "Menu" icon.
2. Select "History".
3. Enable "Show History".
The segment table and the history player are shown.
4. Stop the acquisition.
The captured segments are listed in the segment table, and the buttons in the history player are active.

To disable the history

- ▶ In the history player, tap "Exit".
If you close only the segment table, you can use the history player and see the waveform segments in greater detail. To open the segment table again, open the "History" menu, and tap "Show History".

6.4.3 History Settings

History and segmentation settings are located in the "History" menu. The "Acquisition" provides an additional setting: "Nx Single".

1. Activate the history.
2. If you want to set an individual record length or segment number, disable "Auto".
If "Auto" is enabled, the record length is selected in the "Acquisition" menu.
3. Set the "Record Length", or "No. of Segments".
The record length and the number of segments are interdependent, if one parameter is set, the other is adjusted by the instrument.
4. If necessary, enable [Fast Segmentation](#).
5. Set the number of waveforms to be captured by a [Single] acquisition:
 - a) Press the [Acquisition] key.
 - b) Set [Nx Single](#).

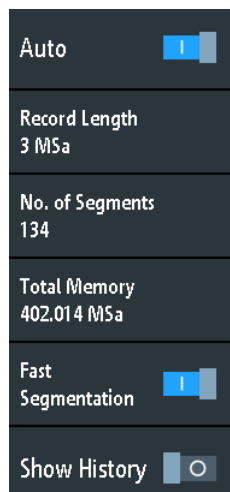

The "History" menu has the following settings:

Auto

Defines how the record length and number of segments are set: automatically by the instrument, or by setting the record length or number of segments manually.

In automatic mode, you can adjust the record length in the "Acquisition" menu. Automatic setting of the number of segments takes effect only if auto trigger is set. When you change from auto to normal trigger mode, the current segment size remains.

Remote command:

[ACQUIRE:MEMORY\[:MODE\]](#) on page 476

Record Length

Shows or sets the record length, depending on the selected "Auto" mode. Record length is the number of waveform samples that are stored in one waveform record. The number of available history segments is adjusted automatically.

Remote command:

[ACQUIRE:POINTS:AUTOMATIC](#) on page 431

[ACQUIRE:POINTS\[:VALUE\]](#) on page 431

No. of Segments

Shows or sets the number of history segments in the memory, depending on the selected "Auto" mode. The record length is adjusted accordingly. When you change the number of segments, the history is deleted.

See also: [Chapter 6.4.1, "Segmented Memory"](#), on page 112

Remote command:

[ACQUIRE:COUNT](#) on page 478

Fast Segmentation

If enabled, the acquisitions are performed as fast as possible, without processing and displaying the waveforms. When acquisition has been stopped, the data is processed and the latest waveform is displayed. Older waveforms are stored in segments. You can display and analyze the segments using the history.

See also: [Chapter 6.4.1, "Segmented Memory"](#), on page 112

Remote command:

[ACQUIRE:SEGMENTED:STATE](#) on page 478

Show History

Enables or disables the history.

6.4.4 Segment Table and History Player

The memory segments are continuously written when an acquisition is running. When you activate the history, the segment table opens but it is empty when the acquisition is running. When you stop the acquisition, the captured segments are listed in the segment table, and the history player becomes active.

The segment table shows the index and timestamp of all history segments, and whether the segment was captured on a trigger event or in auto mode. Below the table, you find the history player with functions to view the segments that are stored in the memory.

The history segments store the data of the currently active channels. You can acquire several channels at once, and display and analyze the channels individually.

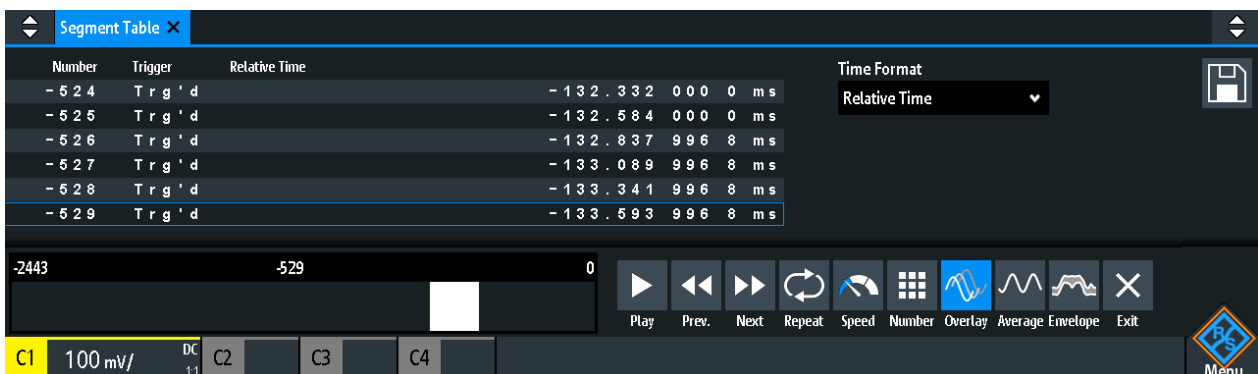

You can show all history segments in sequence, or display a single segment.

To display history segments

1. Activate the history.
2. Stop the acquisition.
3. Set the "Time Format" to be shown in the table: absolute or relative time.
4. Set the "Speed".
5. To play all segments once, tap "Run".
6. To play all segments repeatedly:
 - a) Enable the "Repeat" button.
 - b) Tap "Run".

7. To access a particular segment, you can:
 - Tap the segment in the segment table.
 - Drag the slider until the required segment number is shown.
 - Tap "Number" and enter the segment number. The newest segment has always the number "0". Older segments have a negative number.
 - Use "Prev." and "Next" to show the adjacent segment.
8. If the history segments contain the data of several channels and you want to analyze only one or several channels, disable all channels that you do not need.

Functions in the segment table and history player

Time Format

Sets the format of the timestamp. The timestamp shows the time of the currently displayed history segment. Thus, the time relation between acquisitions is always available. More precisely, the timestamp is the time of the trigger event.

The timestamp can be absolute or relative:

- **Absolute:** Date and daytime of the trigger event of the displayed segment. Depending on the horizontal position, the waveform can be captured up to 100,000 seconds after the trigger event, and thus after the displayed timestamp. The instrument considers this delay automatically, all measurements are related to the trigger event.
- **Relative:** time difference of the current segment to the newest segment (index = 0).

Remote command:

[CHANnel<m>:HISTory:TMODE](#) on page 484

[Chapter 16.6.5.3, "Timestamps"](#), on page 482

Save

Saves the segment table to a CSV file on a connected USB flash drive. The file contains all timestamps: relative time, time to previous, and absolute time. To save the waveform segments, use [Save Load] key > "Waveforms".

See also: [Chapter 6.4.5, "Exporting History Data"](#), on page 118.

Remote command:

[EXPort:ATABLE:NAME](#) on page 487

[EXPort:ATABLE:SAVE](#) on page 487

Play

Starts and stops the playback of the history segments.

Remote command:

[...:HISTory:PLAYer:STATe](#)

Prev.

Steps back to the next older segment.

Next

Steps forward to the next newer segment.

Repeat

If selected, the playback of the selected history segments repeats automatically.

Remote command:

```
...:HISTory:REPLay
```

Speed

Sets the speed of the history playback: automatic, slow, middle, or fast.

Remote command:

```
...:HISTory:PLAYer:SPEEd
```

Number

Accesses a particular history segment in the memory to display it. The newest acquisition segment has always the index "0". Older segments have a negative index. You can also drag the slider, which is above the icons. The current segment is shown in the index bar.

Remote command:

```
...:HISTory:CURRent
```

Overlay

Displays the segments with infinite persistence. Thus, you can see all data points of all displayed segments of a player cycle.

Average

Calculates and displays the average of the current segment and the segments before. At the newest segment, the average of all segments is shown. Player restart resets the average calculation. Average requires a stable, triggered and repetitive signal.

Envelope

Displays the envelope that is built from the maximum and minimum values of the current segments and the segments before. At the newest segment, the envelope of all segments is shown. Player restart resets the envelope calculation.

Exit

Disables the history, and closes the segment table and the history player.

6.4.5 Exporting History Data

Data of history segments can be saved to files on a USB flash drive even if the history is not active ("Show History" is disabled). You can select to save all visible channels, or one channel. In addition, you can save the complete time information of the segment table.

6.4.5.1 Saving History to File

Before you can save history data, acquire the waveform and activate the history, so that the segment table is visible.

To save the waveform history segments

1. Connect a USB flash drive to the instrument.
2. Press the [Save Load] key.
3. Select "Waveforms" in the menu.
4. Under "Points", select "History Data".
5. Under "Source", select whether you want to store all visible channels, or one of them.
6. Enter the "File Name". This name is the name of the folder that contains the segment files.
The file format is CSV.

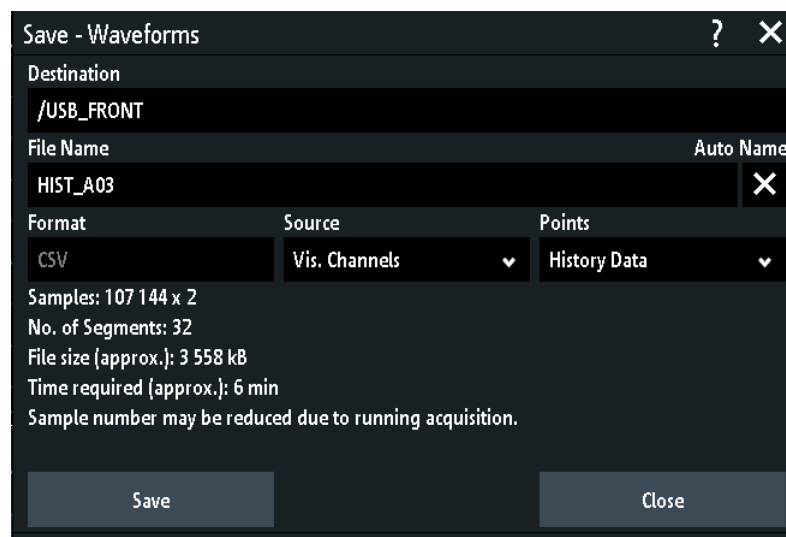

7. To select the target folder, tap the "Destination" field.
The location is always "/USB_FRONT", saving to internal storage is not provided.
8. Tap "Save".
A message shows the progress of the saving process.
9. Close the dialog box.

To save the segment table

1. Connect a USB flash drive to the instrument.
2. In the segment table window, tap "Save".
3. To select the target folder, double-tap it.
4. Tap "New File".
5. Enter the filename.
6. Tap "Enter".

The file is saved immediately, and the window is closed.

6.4.5.2 File Organization and Content

The segment table and history segments are saved to CSV files.

Segment table

The segment table file contains all information that is shown in the table, and also all timestamps: relative time, time to previous, and absolute time.

1		Date	Time				
2	Start of Acquisition	2017-10-13	13:55:19				
3	Last Acquisition	2017-10-13	13:55:27				
4	Acquisitions		53				
5	Number	Relative Time	Time to Previous	Date	Time		Trigger
6		0-0.000000000000000E+00	5.029015392000000E-01	2017-10-13	13:55:27	0.0000000000E+00	Auto
7		-1-5.029015392000000E-01	1.234122592000000E-01	2017-10-13	13:55:26	4.9709846080E-01	Trg'd
8		-2-6.263137984000000E-01	1.004664000000000E-02	2017-10-13	13:55:26	3.7368620160E-01	Trg'd
9		-3-6.363604384000000E-01	1.001169600000000E-02	2017-10-13	13:55:26	3.6363956160E-01	Trg'd

Figure 6-10: Content of a segment table file

Waveforms

Each history segment is saved to a separate file, and all segment files are written to a folder that contains only the files of the saved acquisition. You can specify the name of the folder. The names of the data files include the segment index.

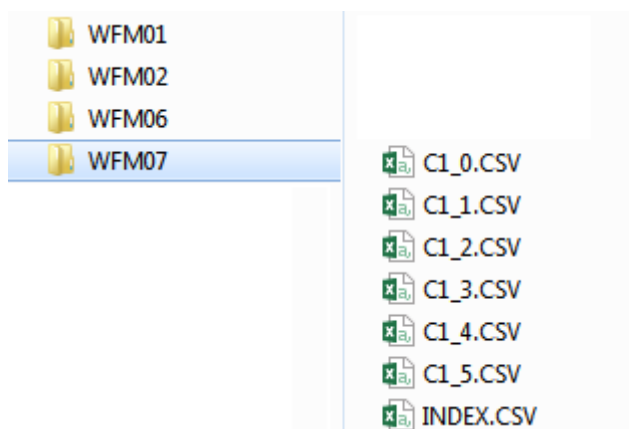

Figure 6-11: Content of a history waveform folder

The data files contain the time and voltage data of the samples. If you save all visible channels, the voltages of all channels are written into one file.

in s,C1 in V,C2 in V
-3.00000E-04,-5.518E-03,2.540E-01
-2.99994E-04,-6.982E-03,2.510E-01
-2.99989E-04,-6.982E-03,2.515E-01
-2.99983E-04,-6.982E-03,2.510E-01
-2.99978E-04,-6.006E-03,2.515E-01
-2.99972E-04,-6.982E-03,2.530E-01
-2.99966E-04,-9.424E-03,2.505E-01
-2.99961E-04,-6.982E-03,2.500E-01
-2.99955E-04,-6.494E-03,2.544E-01
-2.99950E-04,-5.518E-03,2.505E-01

Figure 6-12: Content of a history segment file, two channels are saved

In addition to the data files, an index file is written. The index file delivers information on the files and the segments. For each segment, the segment index, save date and time, and the filename is listed.

Number,Date,Time,Thousandths in ms,Filename
0,2017-04-18,16:18:10,0.000000000e0,C1_0.CSV
-1,2017-04-18,16:18:09,994.600019200e-3,C1_1.CSV
-2,2017-04-18,16:18:09,989.699993600e-3,C1_2.CSV
-3,2017-04-18,16:18:09,984.800000000e-3,C1_3.CSV
-4,2017-04-18,16:18:09,979.499961600e-3,C1_4.CSV
-5,2017-04-18,16:18:09,974.599961600e-3,C1_5.CSV

Figure 6-13: Content of a history index file

6.5 Search

6.5.1 Search Conditions and Results

The search functions of R&S RTM3000 can find all edges, pulse widths, peaks, or other events in an acquisition that match the search conditions. For each search type, specific settings are available. Searches can be performed on channel, math or reference waveforms, available sources depend on the search type.

To configure the search

1. Press the [Search] key.
2. Select the waveform that you want to search for events: "Source".
3. Select the event type that you want to find: "Search Type".
4. Configure the search conditions: "Setup".

The found events and the search conditions are shown in the result table at the bottom of the display. The table shows the following result values: result number, time value, and optional value depending on the search type (voltage, width).

During running acquisition, the results in the table are updated continuously, and the events are marked at the top of the diagram by a brown triangle outline.

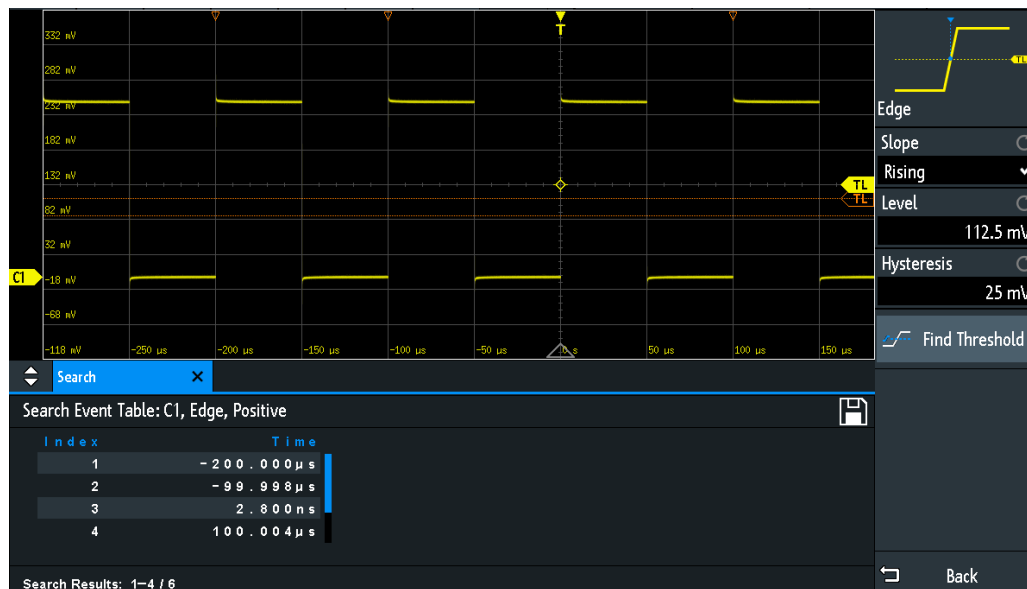

Figure 6-14: Search results and settings during running acquisition

Remote commands to get search results:

- [SEARCH:RCOUNT?](#) on page 476
- [SEARCH:RESULT:ALL?](#) on page 475
- [SEARCH:RESULT<n>?](#) on page 475
- [SEARCH:RESDIAGRAM:SHOW](#) on page 474
- [SEARCH:RESULT:BCOUNT?](#) on page 474

To display search results

When the acquisition is stopped, you can browse the search results.

1. Stop the acquisition.
2. Tap the search result that you want to analyze. If necessary, scroll the list.
The selected event is marked by a filled triangle and a magnifying glass.

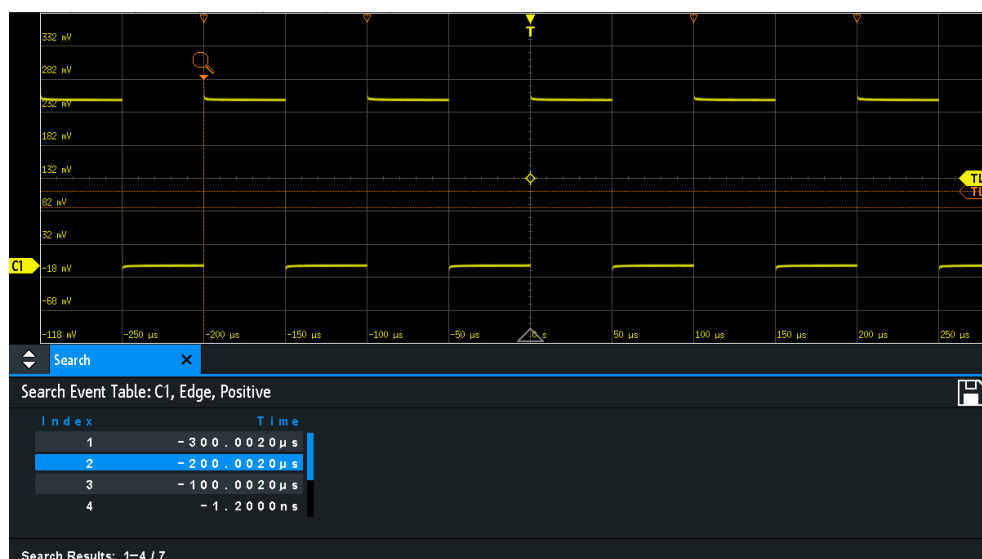

- In the "Search" menu, select "Track event".

The selected event is moved to the reference point. If you select another event, it is shown at the same position.

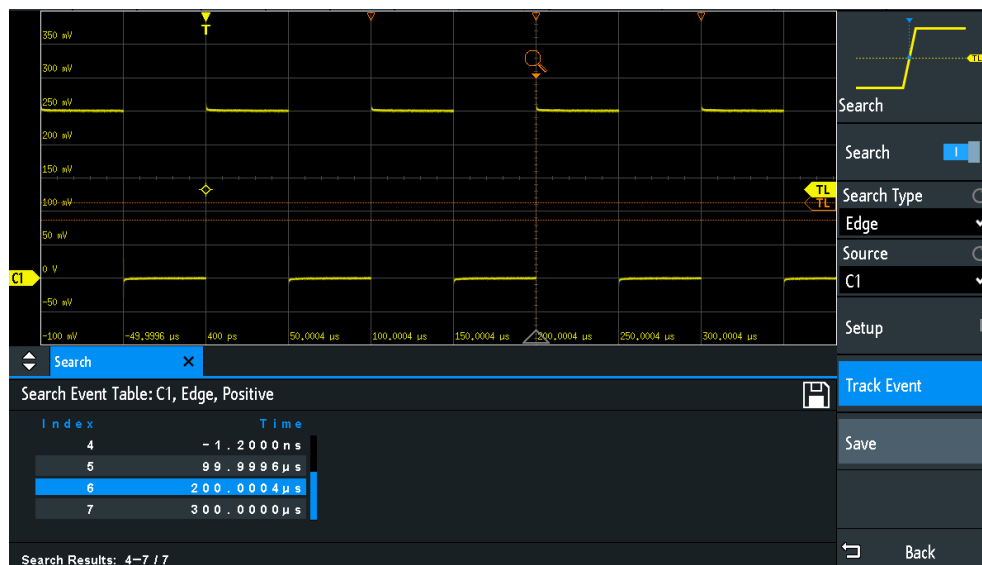

To save search results

- In the upper right corner of the search result table, tap the "Save" symbol.
- Connect a USB flash drive if you want to save the data outside the instrument.
- Select the correct "Destination" and the path.
You can also store the data on the instrument. Therefore, select the "Destination" "/INT/SEARCH".
- If necessary, change the filename and enter a comment.

5. Tap "Save".

The data is saved to a CSV file.

6.5.2 General Search Settings

General search settings are independent of the search type. They are described in the current section. The specific settings for individual search types are described in the following sections.

- ▶ To open the "Search" menu, press the [Search] key.

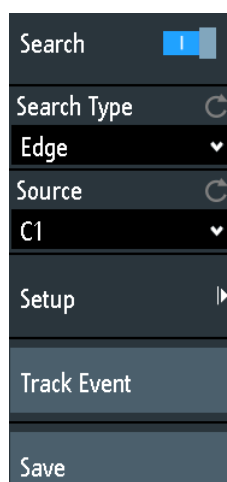

Search

Enables and disables the search mode.

Remote command:

[SEARCh:STATe](#) on page 461

Search Type

Selects the event type you want to search for.

- | | |
|---------|---|
| "Edge" | Similar to the edge trigger, an edge search result is found when the waveform passes the given level in the specified direction.
For settings, see Chapter 6.5.3, "Edge Search" , on page 126. |
| "Width" | The width search finds pulses with an exact pulse width, or pulses shorter or longer than a given time, or pulses inside or outside the given time range. It is similar to the width trigger.
For settings, see Chapter 6.5.4, "Width Search" , on page 127. |
| "Peak" | The peak search finds pulses exceeding a given peak-to-peak value.
For settings, see Chapter 6.5.5, "Peak Search" , on page 128. |

- "Rise/Fall time" The rise or fall time search finds slopes with an exact rise or fall time, or rise/fall times shorter or longer than a given limit, or rise/fall times inside or outside a given time range.
For settings, see [Chapter 6.5.6, "Rise/Fall Time Search"](#), on page 129.
- "Runt" The runt search finds pulses lower than normal in amplitude. In addition, you can define a time limit for the runt.
For settings, see [Chapter 6.5.7, "Runt Setup"](#), on page 130.
- "Data2Clock" The Data2Clock search - also known as setup/hold - finds violation of setup and hold times. It analyzes the relative timing between two signals: a data signal and the synchronous clock signal.
For settings, see [Chapter 6.5.8, "Data2Clock"](#), on page 132.
- "Pattern" The pattern search finds logical combinations of channel states inside or outside a specified time range. For each channel, its state and threshold level is defined. The states are combined logically, and the time of true pattern results is compared with a specified time range.
For settings, see [Chapter 6.5.9, "Pattern Search"](#), on page 133.
- "Protocol" The protocol search finds various events in decoded data serial signals. The events are protocol-specific and correspond to the trigger settings of the serial protocol.
- "Window" The window search checks the signal run in relation to a "window". The window is formed by the upper and lower voltage levels. The search condition is fulfilled, if the waveform enters or leaves the window, or if the waveform stays inside or outside for a time longer or shorter than specified.
For settings, see [Chapter 6.5.10, "Window Search"](#), on page 135.

Remote command:

[SEARCH:CONDition](#) on page 461

Source

Selects the waveform to be analyzed by search. Available sources depend on the selected search type.

Edge, width and pattern search you can perform on analog and logic channels. Peak, rise/fall and runt search are possible on active analog channels, math and reference waveforms. For Data2Clock search, you need two active analog channels.

For protocol search, select the configured bus.

Remote command:

[SEARCH:SOURce](#) on page 462

Setup

Opens a menu to define the search parameters for the selected search type.

Track event

If enabled, the selected result is moved to the reference point. Thus you can always see the selected event in the diagram.

Save

Opens a dialog box to save the search results. The file format is CSV.

Remote command:

[EXPort:SEARCh:NAME](#) on page 476

[EXPort:SEARCh:SAVE](#) on page 476

6.5.3 Edge Search

Similar to the edge trigger, an edge search result is found when the waveform passes the given level in the specified direction.

▶ [Search] > "Search Type" = "Edge" > "Setup"

**Slope**

Sets the slope to be found: rising, falling, or both slopes.

Remote command:

[SEARCh:TRIGger:EDGE:SLOPe](#) on page 463

Level

Sets the voltage level for the search. To let the instrument set the level, tap "Find Threshold".

Remote command:

[SEARCh:TRIGger:EDGE:LEVel](#) on page 463

Hysteresis

Sets a hysteresis range to the search level to avoid unwanted search results caused by noise oscillation around the level. To let the instrument set the hysteresis, tap "Find Threshold".

For a rising edge, the hysteresis is below the search level. Otherwise, for a falling edge the hysteresis is above the level.

Remote command:

[SEARCh:TRIGger:EDGE:LEVel:DELTA](#) on page 463

Find Threshold

Analyzes the signal, sets the level to 50% of the signal amplitude, and also sets the hysteresis.

6.5.4 Width Search

The width search finds pulses with an exact pulse width, or pulses shorter or longer than a given time, or pulses inside or outside the allowable time range. It is similar to the width trigger.

► [Search] > "Search Type" = "Width" > "Setup"

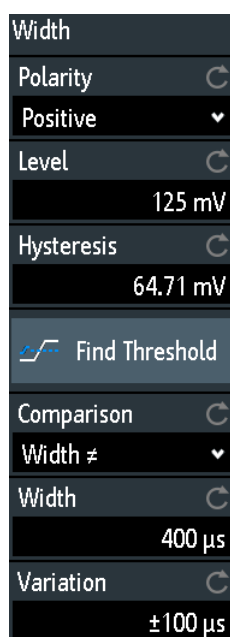
**Polarity**

Indicates the polarity of the pulse to be searched for.

Remote command:

[SEARCH:TRIGGER:WIDTH:POLARITY](#) on page 463

Level

Sets the voltage level on which the pulse width is measured. To let the instrument set the level, tap "Find Threshold".

Remote command:

[SEARCH:TRIGGER:WIDTH:LEVEL](#) on page 463

Hysteresis

Sets a hysteresis range to the search level to avoid unwanted search results caused by noise oscillation around the level. To let the instrument set the hysteresis, tap "Find Threshold".

Remote command:

[SEARCh:TRIGGer:WIDTh:LEVel:DELTA](#) on page 464

Comparison

Sets the condition how the measured pulse width is compared with the given limits.

The comparison works like the comparison of the width trigger, see [Chapter 5.6, "Width Trigger"](#), on page 79.

Remote command:

[SEARCh:TRIGGer:WIDTh:RANGe](#) on page 464

Width

Sets the reference pulse width, the nominal value for comparisons.

Remote command:

[SEARCh:TRIGGer:WIDTh:WIDTh](#) on page 464

Variation

Sets a range Δt to the reference "Width" if comparison is set to "Equal" or "Not equal". The instrument finds pulses inside or outside the range width $\pm \Delta t$.

Remote command:

[SEARCh:TRIGGer:WIDTh:DELTA](#) on page 464

6.5.5 Peak Search

The peak search finds pulses exceeding a given peak-to-peak value (magnitude).

► [Search] > "Search Type" = "Peak" > "Setup"

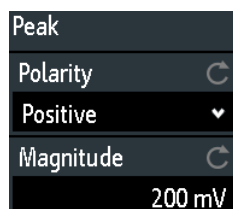

Polarity

Indicates the polarity of the pulse to be searched for a peak.

Remote command:

[SEARCh:MEASure:PEAK:POLarity](#) on page 465

Magnitude

Sets the peak-to-peak limit. If the signal exceeds this limit, a search event is listed.

Remote command:

[SEARCh:MEASure:LEVel:PEAK:MAGNitude](#) on page 465

6.5.6 Rise/Fall Time Search

The rise or fall time search finds slopes with an exact rise or fall time, or rise/fall times shorter or longer than a given limit, or rise/fall times inside or outside the allowable time range.

► [Search] > "Search Type" = "Rise/Fall Time" > "Setup"

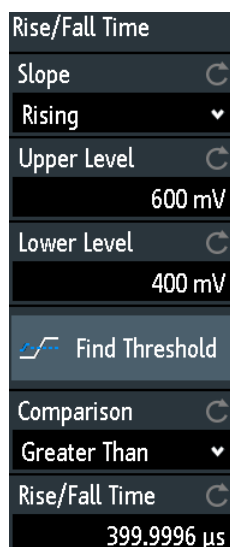

Edge

Sets the slope to be found:

- "Rising" to search for rise time
- "Falling" to search for fall time
- "Both" to search for rise and fall time

Remote command:

[SEARCH:TRIGger:RISetime:SLOPe](#) on page 465

Upper Level, Lower Level

Set the upper and lower voltage thresholds. When the signal crosses the first level, the rise/fall time measurement starts. It stops when the signal crosses the second level. To let the instrument set the levels, tap "Find Threshold".

Remote command:

[SEARCH:TRIGger:LEVel:RISetime:LOWer](#) on page 465

[SEARCH:TRIGger:LEVel:RISetime:UPPer](#) on page 466

Comparison

Sets how the measured rise or fall time is compared with the given limits.

- "Greater than" Finds rise/fall times longer than the given "Rise/Fall Time".
- "Lower than" Finds rise/fall times shorter than the given "Rise/Fall Time".

"Equal"	Finds rise/fall times equal to the reference "Rise/Fall Time" if "Variation" $\Delta t = 0$. If "Variation" $\neq 0$, the setting finds rise/fall times within the range time $\pm \Delta t$.
"Not equal"	Finds rise/fall times unequal to the reference value if "Variation" $\Delta t = 0$. If "Variation" $\neq 0$, the setting finds rise/fall times outside the range time $\pm \Delta t$.

Remote command:

[SEARCh:TRIGger:RISetime:RANGe](#) on page 466

Rise/Fall Time

Sets the reference rise or fall time, the nominal value for comparisons.

Remote command:

[SEARCh:TRIGger:RISetime:TIME](#) on page 466

Variation

Sets a range Δt to the reference "Rise/Fall Time" if comparison is set to "Equal" or "Not equal". The instrument finds rise/fall times inside or outside the range width $\pm \Delta t$.









Remote command:

[SEARCh:TRIGger:RISetime:DELTA](#) on page 466

6.5.7 Runt Setup

The runt search finds pulses lower than normal in amplitude. The amplitude crosses the first threshold twice without crossing the second one. In addition to the threshold amplitudes, you can define a time limit for the runt in the same way as for width search: runts with exact width, shorter or longer than a given time, or runts inside or outside the allowable time range.

► [Search] > "Search Type" = "Runt" > "Setup"

Runt
Polarity 
Positive 
Upper Level 
600 mV
Lower Level 
400 mV
 Find Threshold
Comparison 
Width ≠ 
Width 
400 μs
Variation 
±100 μs

Polarity

Indicates the polarity of the pulse to be searched for.

Remote command:

[SEARCH:TRIGGER:RUNT:POLarity](#) on page 467

Upper Level

Sets the upper voltage threshold for runt detection. A negative runt crosses the upper level twice without crossing the lower level.

Remote command:

[SEARCH:TRIGGER:LEVEL:RUNT:UPPer](#) on page 467

Lower Level

Sets the lower voltage threshold for runt detection. A positive runt crosses the lower level twice without crossing the upper level.

Remote command:

[SEARCH:TRIGGER:LEVEL:RUNT:LOWer](#) on page 467

Comparison

Sets the condition how the measured runt width is compared with the given limits.

The comparison works like the comparison of the width trigger, see [Chapter 5.6, "Width Trigger"](#), on page 79.

Remote command:

[SEARCH:TRIGGER:RUNT:RANGe](#) on page 467

Width

Sets the reference runt pulse width, the nominal value for comparisons.

Remote command:

[SEARCH:TRIGGER:RUNT:WIDTh](#) on page 468

Variation

Sets a range Δt to the reference "Width" if comparison is set to "Equal" or "Not equal". The instrument finds pulses inside or outside the range width $\pm \Delta t$.

Remote command:

[SEARCh:TRIGger:RUNT:DELTA](#) on page 468

6.5.8 Data2Clock

The Data2Clock search - also known as setup/hold search - finds violation of setup and hold times. It analyzes the relative timing between two signals: a data signal and the synchronous clock signal.

Many systems require, that the data signal must be steady for some time before and after the clock edge. Setup time is the time that the data signal is steady before clock edge. Hold time is the time that the data signal is steady after clock edge.

► [Search] > "Search Type" = "Data2Clock" > "Setup"

The settings for Data2Clock search are provided in two menus. In the "Setup" menu, you define the clock polarity, setup and hold times; and in the "Source Setup" menu you define the waveforms to be used, and the levels and hysteresis for each source.

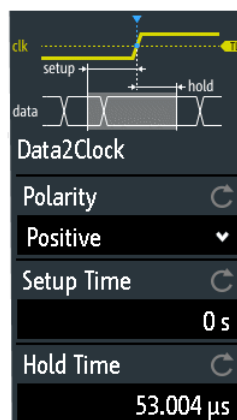
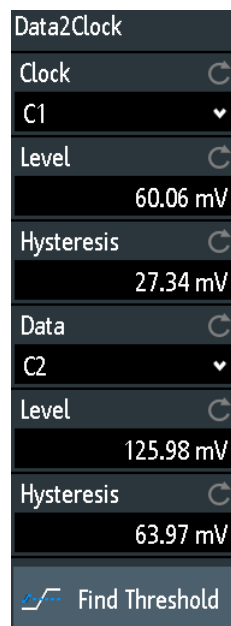
**Clock**

Selects the input channel of the clock signal.

Remote command:

[SEARCh:TRIGger:DATatoclock:CSource](#) on page 468

Data

Selects the input channel of the data signal.

Remote command:

[SEARCH:SOURce](#) on page 462

Level

Set the voltage levels for clock and data signals. The crossing of clock level and clock edge defines the start point for setup and hold time. The data level defines the threshold for data transition. To let the instrument set the level, tap "Find Threshold".

Remote command:

[SEARCH:TRIGger:DATatoclock:CLEVel](#) on page 469

[SEARCH:TRIGger:DATatoclock:DLEVel](#) on page 469

Hysteresis

Sets a hysteresis range to the search level of the selected signal to avoid unwanted search results caused by noise oscillation around the level. To let the instrument set the hysteresis, tap "Find Threshold".

Remote command:

[SEARCH:TRIGger:DATatoclock:CLEVel:DELTA](#) on page 469

[SEARCH:TRIGger:DATatoclock:DLEVel:DELTA](#) on page 469

Polarity

Sets the edge of the clock signal to define the start point for the setup and hold time.

"Rising" Only positive clock edges are considered.

"Falling" Only negative clock edges are considered.

"Either" The clock edges next to the data edge are considered regardless of the clock slope. Use this setting, for example, for signals with double data rate.

Remote command:

[SEARCH:TRIGger:DATatoclock:CEdGe](#) on page 469

Setup Time

Sets the minimum time **before** the clock edge while the data signal must stay steady above or below the data level.

Remote command:

[SEARCH:TRIGger:DATatoclock:STIME](#) on page 470

Hold Time

Sets the minimum time **after** the clock edge while the data signal must stay steady above or below the data level.

Remote command:

[SEARCH:TRIGger:DATatoclock:HTIME](#) on page 469

6.5.9 Pattern Search

For pattern search, up to four analog channels can be used as source. If MSO option R&S RTM-B1 is installed, also digital channels can be included in the pattern. For each channel, you define the state. The states are combined logically, and the time of true

pattern results is compared with a specified time range. Thus you can find state transitions inside or outside this time range.

- Select [Search] > "Search Type" = "Pattern" > "Setup".

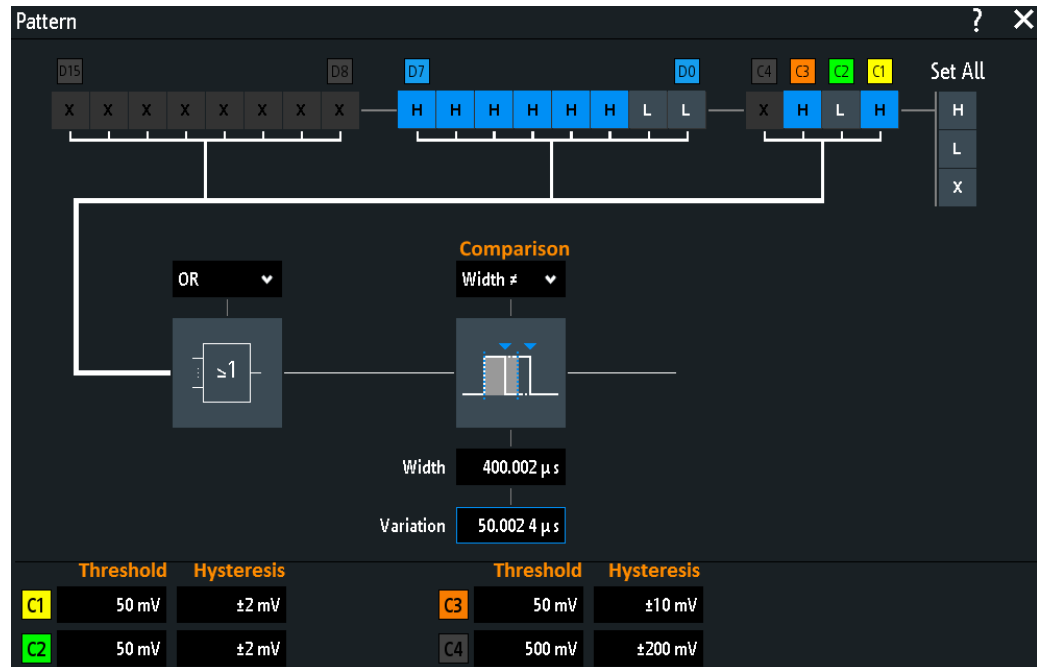

Threshold, Hysteresis

Sets the search threshold value for each analog channel. If the signal value is higher than the threshold, the signal state is high. Otherwise, the signal state is considered low.

For each analog channel, set a hysteresis to avoid unwanted search results caused by noise oscillation of the signal.

Remote command:

[SEARCH:TRIGGER:PATTERN:LEVEL<n>](#) on page 471

[SEARCH:TRIGGER:PATTERN:LEVEL<n>:DELTA](#) on page 471

H | L | X, Set All

Defines the pattern by selecting the state "H" (high), "L" (low) or "X" (do not care, the channel does not affect the search) for each active analog and digital channel.

The word length of the pattern depends on the number of available analog and digital channels. Logic channels are only available with MSO option R&S RTM-B1. Use "Set All" to set all channels to the same state.

Remote command:

[SEARCH:TRIGGER:PATTERN:SOURCE](#) on page 470

AND, OR, NAND, NOR

Sets the logical combination of the channel states.

"AND"	The required states of all channels must appear in the input signal at the same time.
"OR"	At least one of the channels must have the required state.
"NAND"	"Not and" operator, at least one of the channels does not have the required state.
"NOR"	"Not or" operator, no channel has the required state.

Remote command:

[SEARCH:TRIGger:PATTern:FUNCTion](#) on page 470

Comparison

Sets the condition how the duration of a steady pattern is compared with the given limit. The three settings "Width" "Variation" and "Comparison" define the time range how long the true result of the state pattern must be valid.

The comparison works like the comparison of the width trigger, see [Chapter 5.6, "Width Trigger"](#), on page 79.

Remote command:

[SEARCH:TRIGger:PATTern:WIDTh:RANGe](#) on page 471

Width

Sets the limit time of a steady pattern, the nominal value for comparisons.

Remote command:

[SEARCH:TRIGger:PATTern:WIDTh\[:WIDTh\]](#) on page 472

Variation

Sets a range Δt to the reference "Width" if comparison is set to "Equal" or "Not equal". The instrument finds true results of the state pattern inside or outside the range width $\pm \Delta t$.

Remote command:

[SEARCH:TRIGger:PATTern:WIDTh:DELTA](#) on page 472

6.5.10 Window Search

The window search checks the signal run in relation to a "window". The window is formed by the upper and lower voltage levels. The search condition is fulfilled, if the waveform enters or leaves the window, or if the waveform stays inside or outside for a time longer or shorter than specified.

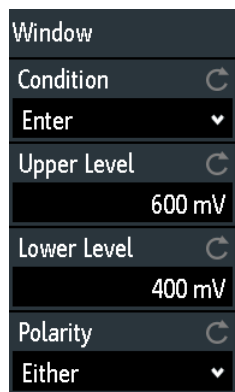

Condition

Selects how the signal runs in relation to the window. Additionally, various time limitations can be defined with "Comparison" for most window conditions.

"Enter"	The signal crosses the upper or lower level and thus enters the window made up of these two levels.
"Exit"	Searches for events when the signal leaves the window.
"Stay within"	The signal stays between the upper and lower level for a specified time.
"Stay outside"	The signal stays above the upper level or below the lower level for a specified time.
"Pass through"	The signal crosses both levels in a specified time. The time measurement starts when the signal crosses the first level.
"Not pass through"	The signal crosses one level, but does not cross the second level in a specified time.

Remote command:

[SEARCH:TRIGGER:WINDOW:RANGE](#) on page 473

Upper Level, Lower Level

Set the upper and lower voltage thresholds. When the signal crosses the first level, the window measurement starts. It stops when the signal crosses the second level. To let the instrument set the levels, tap "Find Threshold".

Remote command:

[SEARCH:TRIGGER:LEVEL:WINDOW:LOWER](#) on page 472

[SEARCH:TRIGGER:LEVEL:WINDOW:UPPER](#) on page 472

Polarity

Indicates the polarity of the pulse to be searched for.

Remote command:

[SEARCH:TRIGGER:WINDOW:POLARITY](#) on page 473

Comparison

Sets the condition how the measured pulse width is compared with the given limits.

The comparison works like the comparison of the width trigger, see [Chapter 5.6, "Width Trigger"](#), on page 79.

Remote command:

[SEARCh:TRIGger:WINDow:TIMerange](#) on page 473

7 Measurements

7.1 Quick Measurements

Quick measurement performs a set of automatic measurements on the selected input channel. The measurements cannot be configured. The results are displayed directly at the waveform (WF) or in the bottom result line (L) and are updated continuously.

If the instrument detects a period in the signal, the quick measurement measures the first cycle and displays the results. If no period is detected, it measures the complete waveform.

- Press the [QuickMeas] key to activate quick measurement.

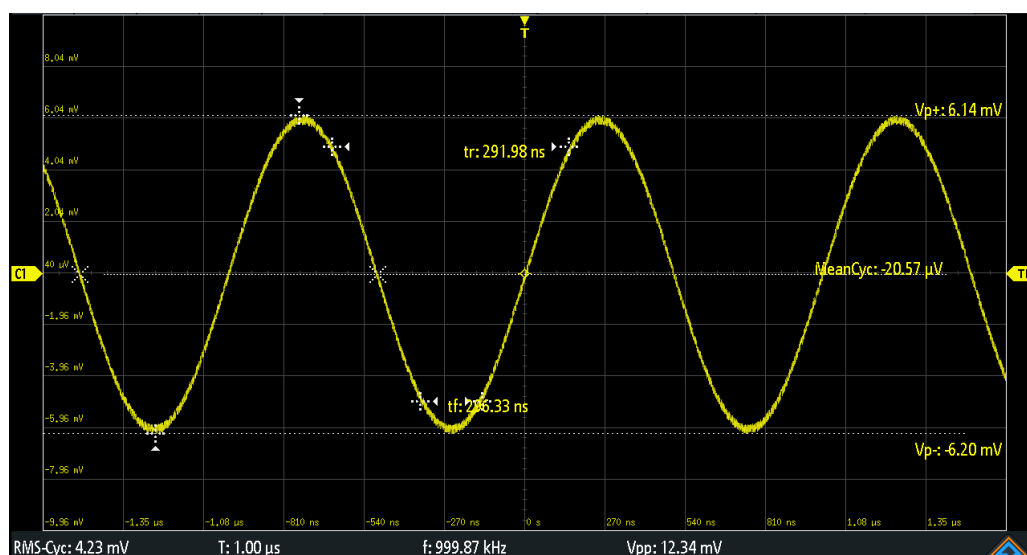

Table 7-1: Results of quick measurement

Label	Description	Display
Vp+	Positive peak value	WF
Vp-	Negative peak value	WF
tr	Rising time of the first rising edge	WF
tf	Falling time of the first falling edge	WF
MeanCyc	Mean value	WF
RMS-Cyc	RMS	L
T	Period length	L
f	Frequency	L
Vpp	Peak to peak value	L

Quick measurement is not available on math and reference waveforms. Channels other than the selected one are switched off in quick measurement mode. When quick measurement is active, cursor measurements are not possible, but you can use automatic measurements in parallel.

- ▶ Press the [QuickMeas] key again to deactivate quick measurement.
The results are deleted on the display.

Remote commands:

- [MEASurement<m>:AON](#) on page 488
- [MEASurement<m>:AOFF](#) on page 488
- [MEASurement<m>:ALL\[:STATe\]](#) on page 488
- [MEASurement<m>:AREsult?](#) on page 488

7.2 Automatic Measurements

You can perform up to 8 different measurements simultaneously.

To configure automatic measurements in the Measure menu

1. Press the [Meas] key.
2. In the menu, select the "Meas. Place", the number of the measurement that you want to configure.
3. If the measurement is off, enable "Measure <n>".
4. Select the measurement type:
 - a) Tap "Type"
 - b) Select the tab of the required measurement category.
 - c) Select the measurement type.

The measurement types are described in [Chapter 7.2.2, "Measurement Types"](#), on page 141.

5. Select the "Source".
The selection list shows all possible sources. If the waveform is not active, it is activated automatically when selected as measurement source.
6. Some measurement types require additional settings. Scroll down the menu, and adjust the additional settings if necessary.
See also: [Chapter 7.2.3, "Settings for Automatic Measurements"](#), on page 145.

7.2.1 Measurement Results

The measurement results are shown in a line below the grid.

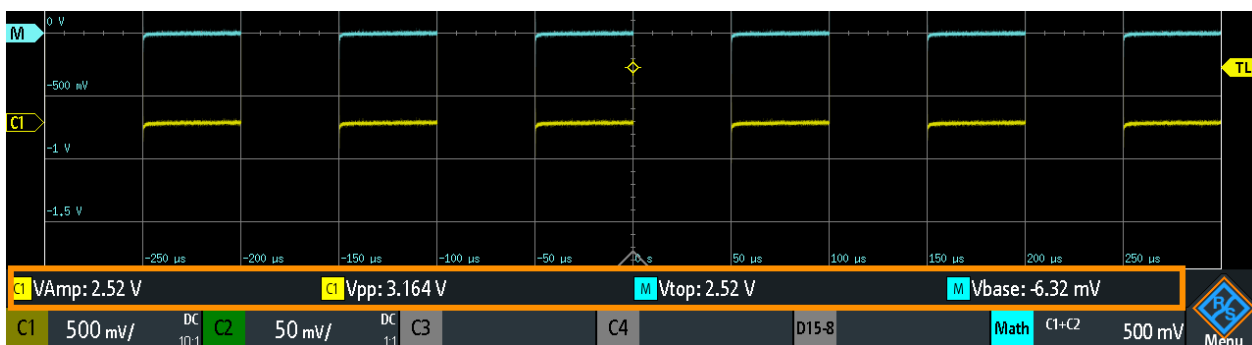

Figure 7-1: Results of four active measurements

If a result cannot be determined, "?" is displayed. Adjust the horizontal and vertical settings if the instrument cannot measure.

If the measurement result is outside the measurement range and clipping occurs, the results are marked with "clipping+" or "clipping-". Adjust the vertical scale to get valid results.

Remote commands are described in:

- [Chapter 16.7.2.2, "Measurements Results"](#), on page 492

7.2.1.1 Statistics

In addition to the current measurement results, you can enable a statistic evaluation. It returns the current, minimum and maximum measurement values, the average and standard deviation, and the number of measured waveforms. The results are shown in a separate tab below the grid. If the cursor measurement is active simultaneously, its results are shown beside the statistic results.

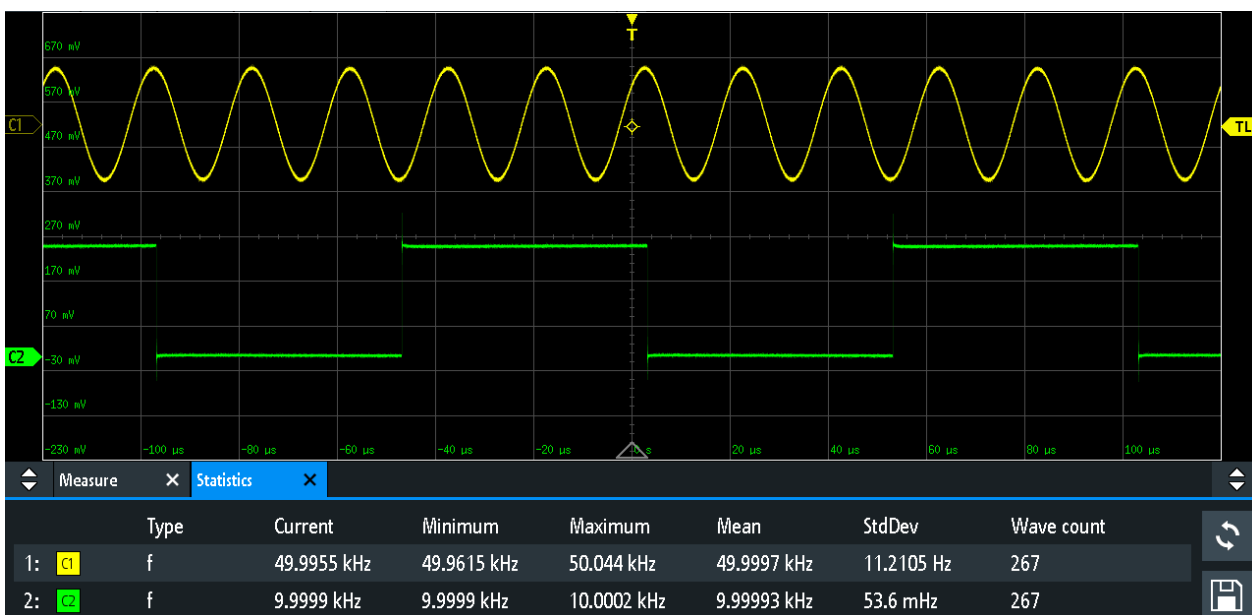

Figure 7-2: Statistic results of four active measurements

1. To delete all measurement results, and to restart statistical evaluation, tap the "Reset" button.
2. To write statistic and measurement results to CSV file, tap the "Save" button.

You can save the statistic results to CSV file for further evaluation. The file contains the statistic values shown on the screen, and also the measurement results of each measured waveform.

9	Meas. Place		1		2
10	Type		Frequency		Frequency
11	Source 1		C1		C2
12	Source 2				
13	Unit		Hz		Hz
14	Upper Level [%]		9,00E+07		9,00E+07
15	Middle Level [%]		5,00E+07		5,00E+07
16	Lower Level [%]		1,00E+07		1,00E+07
17	Wave count		267		267
18	Current		5,00E+10		1,00E+10
19	Average No.		1,00E+09		1,00E+09
20	Minimum		5,00E+10		1,00E+10
21	Maximum		5,00E+10		1,00E+10
22	Mean		5,00E+10		1,00E+10
23	StdDev		1,12E+07		5,35E+04
24	Time of first value				
25	Time of last value				
26	Long term Minimum		5,00E+10		1,00E+10
27	Long term Maximum		5,00E+10		1,00E+10
28	Long term Mean		5,00E+10		1,00E+10
29	Long term StdDev		1,12E+07		5,36E+04
30	Long term start time				
31	Long term end Time				
32					
33					
34	Index	Time Offset	Value	Time Offset	Value
35	1		5,00E+10		1,00E+10
36	2		5,00E+10		1,00E+10
37	3		5,00E+10		1,00E+10
38	4		5,00E+10		1,00E+10
39	5		5,00E+10		1,00E+10
300	...				
301	266		5,00E+10		1,00E+10
302	267		5,00E+10		1,00E+10

Figure 7-3: Exported statistic results, converted to columns with comma delimiter

7.2.2 Measurement Types

The R&S RTM3000 provides many measurement types to measure time and amplitude characteristics, and to count pulses and edges.

7.2.2.1 Horizontal Measurements (Time)

Meas. type	Symbol	Description	Graphic / formula
Frequency	f in Hz	Frequency of the signal, reciprocal value of the measured first period.	
Period	T in s	Time of the first period, measured on the 50% level. The measurement requires at least one complete period of the signal.	
Duty Cycle +	Dty+ in %	Width of the first positive pulse in relation to the period in %. The measurement requires at least one complete period of the signal.	Dty+ = $t+ / T * 100\%$
Duty Cycle -	Dty- in %	Width of the first negative pulse in relation to the period in %. The measurement requires at least one complete period of the signal.	Dty- = $t- / T * 100\%$
Rise Time	tr in s	Rise time of the first rising edge, the time it takes the signal to rise from the 10% level to the 90% level.	
Fall Time	tf in s	Fall time of the first falling edge, the time it takes the signal to fall from the 90% level to the 10% level.	
Pulse Width +	PW+ in s	Duration of the first positive pulse: time between a rising edge and the following falling edge measured on the 50% level.	
Pulse Width -	PW- in s	Duration of the first negative pulse: time between a falling edge and the following rising edge measured on the 50% level.	
Delay	Dly in s	Time difference between two slopes of the same or different waveforms, measured on the 50% level.	

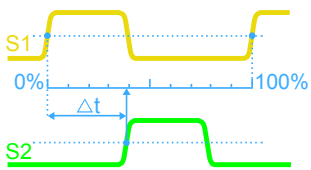
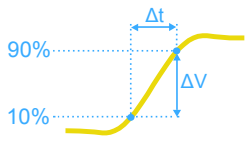
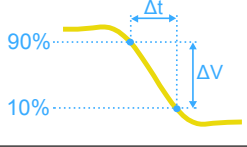
Meas. type	Symbol	Description	Graphic / formula
Phase	Phs in °	Phase difference between two waveforms, measured on the 50% level.	Phase = $\Delta t / T * 360^\circ$ 
Slew rate+	Slewr+	Steepness of the first rising edge, measured between the reference levels 10% and 90%	Slewr+ = $\Delta V / \Delta t$ 
Slew rate-	Slewr-	Steepness of the first falling edge, measured between the reference levels 90% and 10%	Slewr- = $\Delta V / \Delta t$ 
Burst Width	Bst	Duration of one burst, measured on the middle reference level from the first edge to the last edge.	

7.2.2.2 Vertical Measurements (Amplitude)

The unit of most amplitude measurement results depends on the measured source.

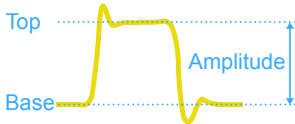
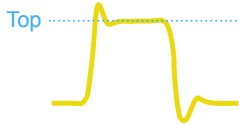
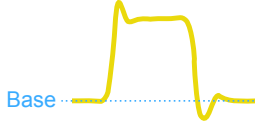
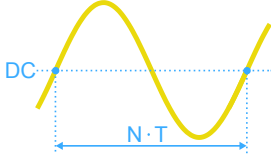
Meas. type	Symbol	Description	Graphic / formula
Amplitude	Vamp	Difference between the top level and the base level of the signal. The measurement requires at least one complete period of the signal.	
Top Level	Vtop	High level of the displayed waveform - the upper maximum of the sample distribution, or the mean value of the high level of a square wave without overshoot. The measurement requires at least one complete period of the signal.	
Base Level	Vbase	Low level of the displayed waveform - the lower maximum of the sample distribution, or the mean value of the low level of a square wave without overshoot. The measurement requires at least one complete period of the signal.	
Mean Cycle	MeanCyc in V	Mean value of the left-most signal period.	

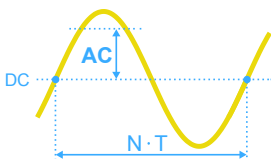
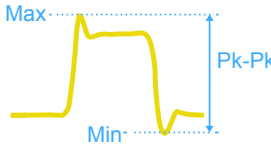
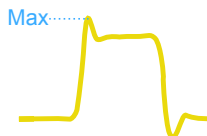
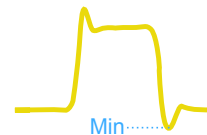
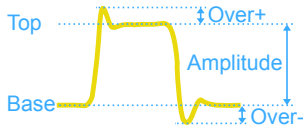
Meas. type	Symbol	Description	Graphic / formula
RMS Cycle	RMS-Cyc in V	RMS (root mean square) value of the voltage of the left-most signal period.	
Peak Peak	Vpp	Difference of maximum and minimum values.	
Peak+	Vp+	Maximum value within the displayed waveform.	
Peak-	Vp-	Minimum value within the displayed waveform.	
Pos. Overshoot Neg. Overshoot	+Ovr -Ovr in %	Overshoot of a square wave after a rising or falling edge. It is calculated from measurement values top level, base level, local maximum, local minimum, and amplitude.	$\text{Over}_+ = \frac{\text{Max}_{\text{local}} - \text{Top}}{\text{Amplitude}} \cdot 100\%$ $\text{Over}_- = \frac{\text{Base} - \text{Min}_{\text{local}}}{\text{Amplitude}} \cdot 100\%$ 
Mean Value	Mean	Arithmetic average of the complete displayed waveform.	$\text{Mean} = \frac{1}{N} \sum_{k=1}^N x_k$
RMS Value	RMS	RMS (root mean square) value of the voltage of the complete displayed waveform.	$\text{RMS} = \sqrt{\frac{1}{N} \sum_{k=1}^N x_k^2}$
σ-Std. Deviation	σ	Standard deviation of the displayed waveform.	$\sigma = \sqrt{\frac{1}{N-1} \sum_{k=1}^N (x_k - \text{Mean})^2}$

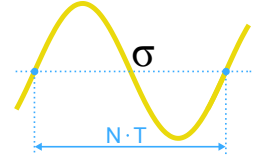
Meas. type	Symbol	Description	Graphic / formula
σ -Std. Dev. Cycle	σ -Cyc	Standard deviation of one cycle, usually of the first, left-most signal period.	
Crest Factor	Crest	The crest factor is also known as peak-to-average ratio. It is the maximum value divided by the RMS value of the displayed waveform.	$\text{Crest} = \frac{\text{Max} x_k }{\text{RMS}}$

7.2.2.3 Counting

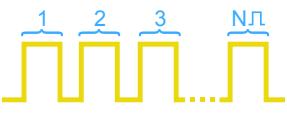
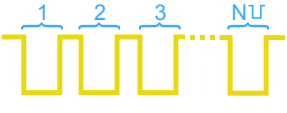
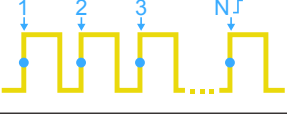
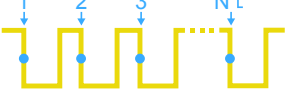
Meas. type	Symbol	Description	Graphic / formula
Positive Pulse	CntP+	Number of positive pulses on the display. The mean value of the signal is determined. If the signal passes the mean value, an edge is counted. A positive pulse is counted if a rising edge and a following falling edge are detected.	
Negative Pulse	CntP-	Number of negative pulses on the display. The mean value of the signal is determined. If the signal passes the mean value, an edge is counted. A negative pulse is counted if a falling edge and a following rising edge are detected.	
Positive Slope	CntS+	Number of rising edges on the display. The instrument determines the mean value of the signal and counts an edge every time the signal passes the mean value in the specified direction.	
Negative Slope	CntS-	Number of falling edges on the display. The instrument determines the mean value of the signal and counts an edge every time the signal passes the mean value in the specified direction.	

7.2.3 Settings for Automatic Measurements

- To open the "Measure" menu, press the [Meas] key.

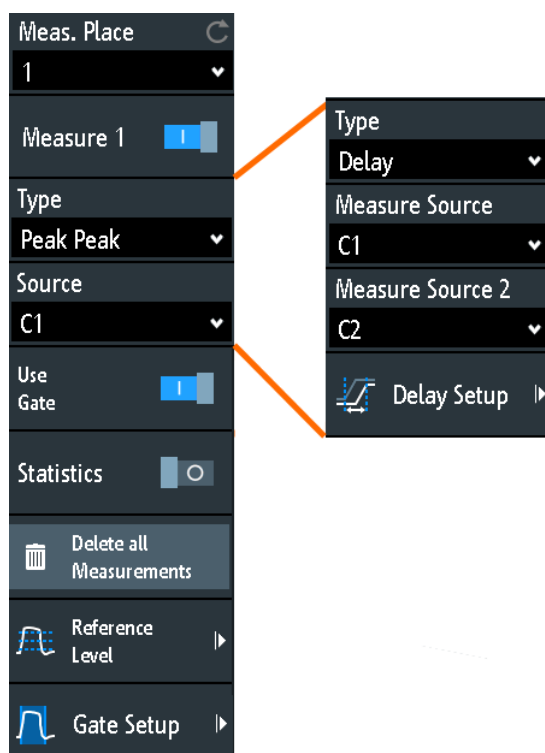

In the measurement menu, you can configure up to 8 parallel measurements (also called measurement places). Available measurement types depend on the type of the selected waveform.

Meas. Place

Selects one of the four available measurement places to be configured or activated.

Measure <n>

Activates or deactivates the selected measurement.

Remote command:

[MEASurement<m>\[:ENABLE\]](#) on page 489

Type

Defines the measurement type to be performed on the selected source. Depending on the type, different results are displayed in the result line.

Select the tab of the required measurement category, and then the measurement type. The "Basic" tab provides the most common measurements: peak to peak, period, frequency, rise time, fall time, mean cycle, and RMS cycle.

Remote command:

[MEASurement<m>:MAIN](#) on page 489

Source

Selects an analog channel, reference or math waveform as the source of the selected measurement. If MSO option R&S RTM-B1 is installed, active digital channels are available as measurement sources.

If the waveform is not active, it is activated automatically when selected as measurement source.

Remote command:

[MEASurement<m>:SOURce](#) on page 491

Measure Source, Measure Source 2

Set the source waveforms for delay and phase measurement, where two sources are required.

Remote command:

[MEASurement<m>:SOURce](#) on page 491

Delay Setup for Measure Source and Measure Source 2

Set the edges to be used for delay measurement. You can measure the delay between two rising edges, two falling edges, between rising and next falling edge, and vice versa.

Remote command:

[MEASurement<m>:DELay:SLOPe](#) on page 492

Use Gate

Activates or deactivates the measurement gate. To set the gate, scroll down and select [Gate Setup](#).

Remote command:

[MEASurement<m>:GATE](#) on page 498

Statistics

Activates or deactivates the statistical evaluation for the selected measurement.

Remote command:

[MEASurement<m>:STATistics\[:ENABLE\]](#) on page 492

Reset Statistics

Deletes the statistical results for all measurements, and starts a new statistical evaluation if the acquisition is running.

Remote command:

[MEASurement<m>:STATistics:RESet](#) on page 492

Delete all Measurements

Deactivates all active measurements.

Reference Level

Upper Level	90 %
Middle Level	50 %
Lower Level	10 %

Set the lower and upper reference levels for rise and fall time measurements. Sets also the middle reference level used for phase and delay measurements. The levels are defined as percentages of the high signal level. The settings are valid for all measurement places.

Remote command:

[REFLevel:RELative:MODE](#) on page 499

[REFLevel:RELative:LOWer](#) on page 500

[REFLevel:RELative:MIDDLE](#) on page 500

[REFLevel:RELative:UPPer](#) on page 500

Gate Setup

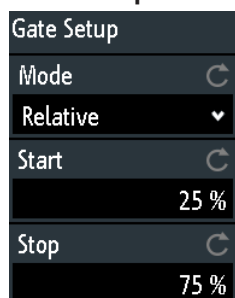

Define a gate to limit the measurement to a time range. You can set the "Start" and "Stop" time in absolute or relative values, depending on the "Mode".

Remote command:

[MEASurement<m>:GATE:MODE](#) on page 498

[MEASurement<m>:GATE:ABSolute:START](#) on page 498

[MEASurement<m>:GATE:ABSolute:STOP](#) on page 498

[MEASurement<m>:GATE:RELative:START](#) on page 499

[MEASurement<m>:GATE:RELative:STOP](#) on page 499

7.3 Cursor Measurements

The cursor measurement determines the results at the current cursor positions. You can set the cursor lines manually at fixed positions, or they can follow the waveform. Cursors are available in time and frequency domain. You can measure on one waveform, or on two different waveforms (sources) if the sources are in the same domain (time domain or frequency domain).

If the measured source is an envelope waveform, and you move the cursor slowly, the minimum and maximum values are measured alternating. Zoom and measurement on second source behave in the same way.

Available results depend on the cursor type and the type of the waveform. They are displayed below the grid.

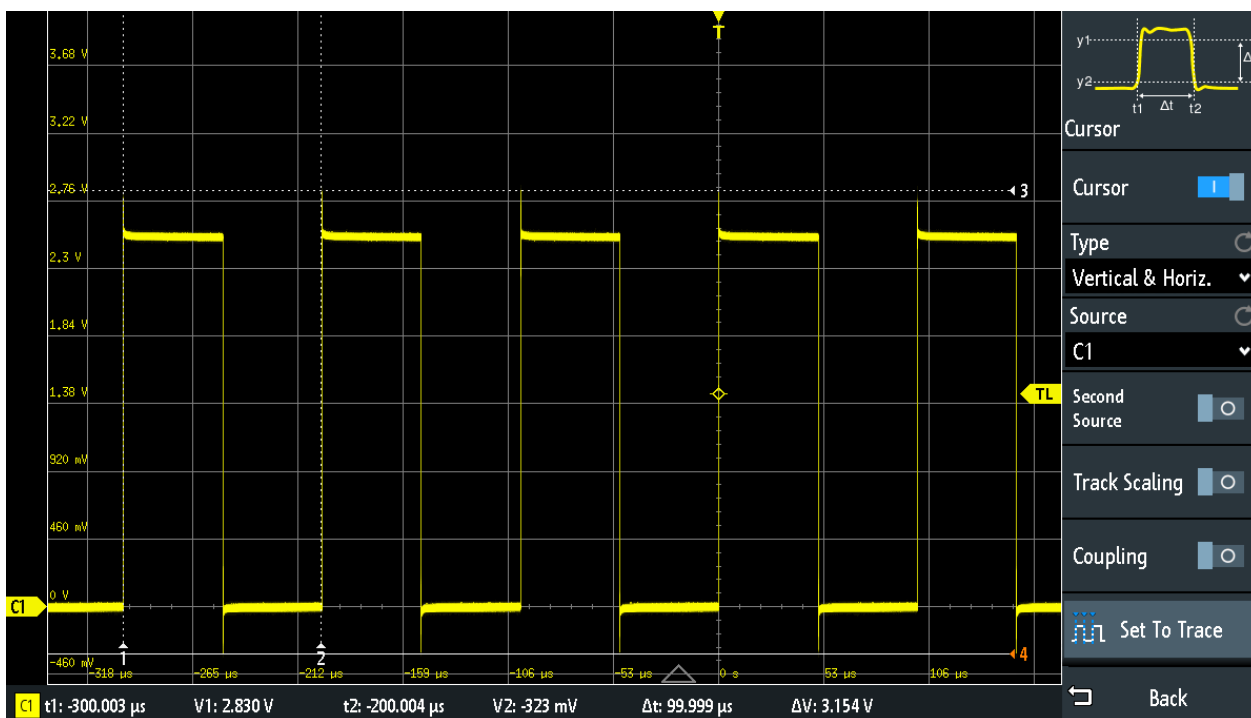

Figure 7-4: Cursor measurement with vertical and horizontal cursors and Set To Trace

Results = below the grid
 Cursor lines 1, 2, 3 = no focus
 Cursor line 4 = has focus, can be moved by turning the [Navigation] knob

To configure cursor measurements

1. Press the [Cursor] key.
The cursors are activated with the latest setting.
2. Press the [Cursor] key again.
The "Cursor" menu opens.
3. Select the cursor "Type".
4. Select the "Source", the waveform you want to measure.
5. If you want to measure different sources:
 - a) Enable "Second Source".
 - b) Select the second waveform.
6. Set additional settings if necessary: [Track Scaling](#), [Coupling](#), or [Set To Trace](#).
7. To change the position of a cursor line, you can use several methods:
 - Drag the cursor line on the screen.
 - Press the [Navigation] knob repeatedly until the required cursor line is active (marked with a solid line).
Turn the knob to move the line.
 - Tap the corresponding result value in the result line at the bottom.

The keypad opens, and you can enter an exact value.

7.3.1 Cursor Settings

- ▶ To open the "Cursor" menu:
 - a) Tap the  "Menu" icon in the lower right corner of the screen.
 - b) Scroll down. Select "Cursor".

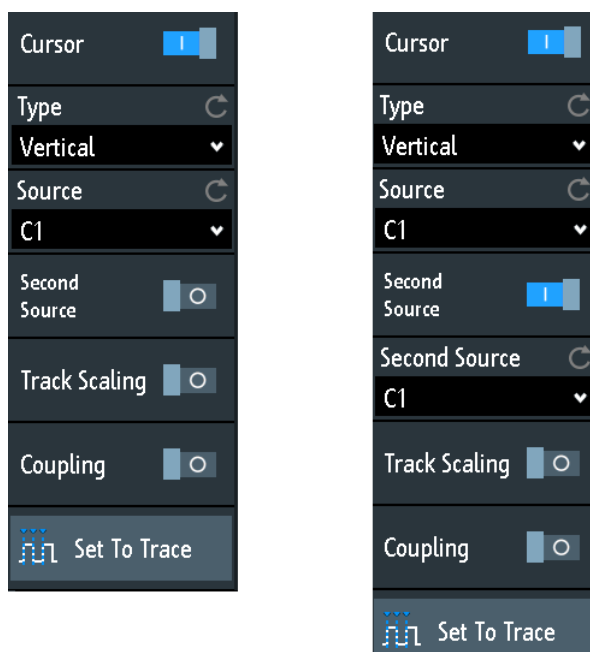

Figure 7-5: Cursor menu, cursor on one source (left), cursor on two sources (right)

Cursor

Activates or deactivates the cursor measurement.

Remote command:

`CURSor<m>:STATe` on page 501

Type

Selects the cursor type. Depending on the type, different results are displayed in the result line at the bottom of the display.

The cursor lines can be set to the required position using the "Navigation" rotary knob, or by dragging a cursor line on the screen.

"Horizontal" Sets two horizontal cursor lines and measures the voltage values at the cursor positions, and the difference between the cursor lines.
Results: V1, V2, ΔV (for current measurements: A1, A2, ΔA , for FFT measurements: L in dBm)

"Vertical"	Sets two vertical cursor lines and measures the time from the trigger point to each cursor line, the time between the cursor lines and the frequency calculated from that time. Results: t1, t2, Δt , $1/\Delta t$ (for FFT measurements: frequencies)
"Vertical & Horiz."	Combines the "Horizontal" cursor and "Vertical" cursor measurements. Two horizontal and two vertical cursor lines are set. The voltages and times are measured at the cursor positions, as well as the delta of the voltage and time values. Results: t1, t2, Δt , V1, V2, ΔV
"V-Marker"	Sets two vertical cursors and measures the values of the waveform at the crossing points of the cursor lines and the waveform. Also, the differences of the two values in x- and y-direction are displayed. Results: t1, V1, t2, V2, Δt , ΔV

Remote command:

[CURSor<m>:FUNctIon](#) on page 501

[CURSor<m>:TRACking\[:STATe\]](#) on page 503 (V-Marker)

Source

Defines the source of the cursor measurement as one of the active waveforms.

You can use cursors on analog input signals, math waveform, reference waveforms, XY-diagram, and FFT waveform.

If option R&S RTM -B1 is installed, you can use the vertical cursor to measure individual logic channels, and the V-Marker to measure pods.

Remote command:

[CURSor<m>:SOURce](#) on page 502

Second Source

Enables and selects a second source for the cursor measurements. If enabled, the second cursor measures on the second source. Using a second source, you can measure differences between two waveforms with cursors. Both sources must be in the same domain (time domain or frequency domain). In FFT, for example, you can measure the difference between min hold and max hold waveforms.



Figure 7-6: Cursor on one source



Figure 7-7: Cursor on two sources. Sources are indicated with the measurement results.

Remote command:

[CURSor<m>:USSOURce](#) on page 503

[CURSor<m>:SSOURce](#) on page 503

Track Scaling

If enabled, the cursor lines are adjusted when the vertical or horizontal scales are changed. The cursor lines keep their relative position to the waveform.

If disabled, the cursor lines remain on their position on the display if the scaling is changed.

Remote command:

[CURSor<m>:TRACking:SCALe\[:STATe\]](#) on page 504

Coupling

If enabled, the cursors lines are coupled and moved together.

Press the [Navigation] key to select whether both cursors or one cursor is moved. If coupling is disabled, pressing the [Navigation] key toggles the single cursor lines.

Remote command:

[CURSor<m>:XCoupling](#) on page 504

[CURSor<m>:YCoupling](#) on page 504

Set To Trace

Autoset for cursor lines, sets the cursor lines to typical points of the waveform depending on the selected cursor type. For example, for voltage measurement ("Horizontal"), the cursor lines are set to the upper and lower peaks of the waveform. For time measurement ("Vertical"), the cursor lines are set to the edges of two consecutive positive or two consecutive negative pulses.

Remote command:

`CURSor<m>:SWAVe` on page 504

8 Applications

All available applications are provided in the "Apps Selection" dialog.

- ▶ To select an application, press the  [Apps Selection] key.

See also: [Chapter 3.2, "Selecting the Application"](#), on page 32.

Applications are grouped on several tabs:

- Applications, see below
- Protocol
Protocol applications are described in [Chapter 12, "Serial Bus Analysis"](#), on page 230.
- Track

On the "Applications" tab, the following applications are available:

- "QuickMeas": see [Chapter 7.1, "Quick Measurements"](#), on page 138
- "Probe Adjust": see [Chapter 4.2, "Adjusting Passive Probes"](#), on page 43
- "Function Gen.": see [Chapter 15.1, "Function Generator"](#), on page 381
- "Pattern Gen.": see [Chapter 15.2, "Pattern Generator"](#), on page 394
- [Mask Testing](#)..... 155
- [FFT Analysis](#)..... 163
- [Spectrum Analysis and Spectrogram \(Option R&S RTM-K18\)](#)..... 171
- [XY-Diagram](#)..... 182
- [Digital Voltmeter](#)..... 184
- [Trigger Counter](#)..... 186
- [Bode Plot \(Option R&S RTM-K36\)](#)..... 187

8.1 Mask Testing

Masks are used to determine whether the amplitude of a signal remains within specified limits, e.g. to detect errors or test compliance of digital signals.

8.1.1 About Masks and Mask Testing

Masks

A mask is specified by an upper and a lower limit line. The signal must run inside these limit lines, otherwise a mask violation occurs.

A new mask is created from an existing signal: Mask limits are created by copying the envelope waveform, and the limits are moved and stretched. The result is a tolerance tube around the signal that is used as mask.

The mask is displayed in the color used for reference waveforms.

Once a mask has been defined, the copied envelope is kept in the instrument until the next mask is defined or loaded. If you need more than one mask, you can save the mask to internal storage and load it at a later time.

Mask testing results

The mask testing analyzes whether tested signal runs inside the mask. The overall test result is shown in the mask window:

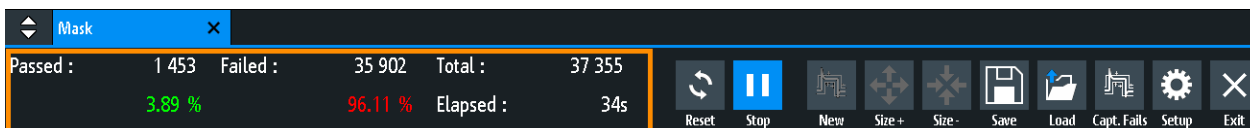

left column = absolute number and percentage of acquisitions that passed the test
middle column = absolute number and percentage of acquisitions that violated the mask
right column = number of tested acquisitions and test duration

During a mask test, various actions can be executed when mask violations occur: notification by a sound, stop of acquisition, saving a screenshot, saving the waveform data, sending a pulse.

Remote commands:

- [MASK:STATe](#) on page 507 to start the mask application
- [MASK:COUNT?](#) on page 511
- [MASK:VCOunt?](#) on page 511

File format for masks: MSK

MSK is the specific binary format for masks of the R&S RTM3000. It contains pairs of amplitude values (in divisions), their sample indexes and current instrument settings. Thus, the amplitude values are not related to time and voltage. The mask data is saved in the internal storage and can be loaded back when needed. The format is not intended for analysis outside the R&S RTM3000.

8.1.2 Using Masks

Starting the mask application

1. Press the [Apps Selection] key.
2. Tap "Mask".

You can also add the mask icon to the toolbar and start the application from the toolbar. See "[Configuring the Toolbar](#)" on page 38.

To create and set up a mask

You create a mask based on a channel waveform, then optimize it by changing its position and proportions, and save it.

1. Select and adjust the channel waveform that you want to use as basis for the mask.
2. Run continuous acquisition.
3. Start the mask application.
4. In the mask window, tap "New".

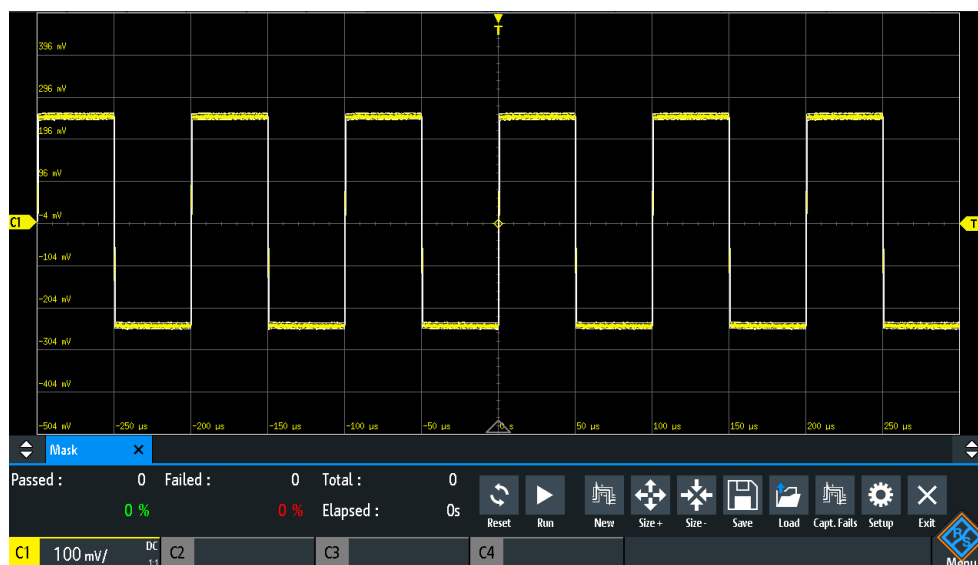

5. Adjust the size of the mask:
 - For simple setup, use "Size+" and "Size-" to change the mask dimensions in x- and y-direction.
 - For detailed setup:
 - Tap "Setup" to open the "Mask" menu.
 - Change "Width Y", "Width X" and/or "Stretch Y".

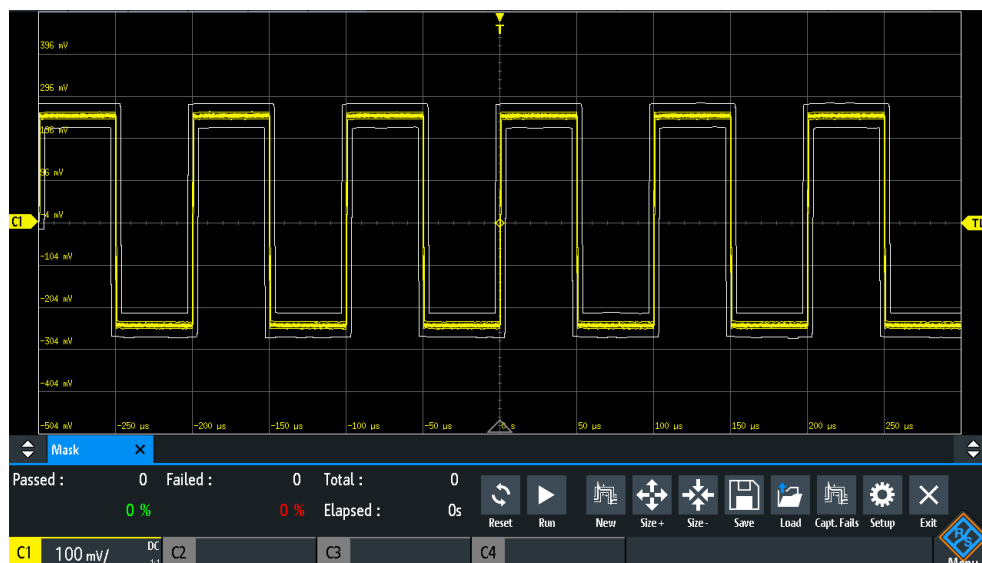

6. To save the mask for later use, tap "Save".

To load a mask

1. Press the  [Apps Selection] key.
2. Tap "Mask".
3. Tap "Load".
4. Select the mask file.
5. Tap "Load".

To perform a mask testing

1. Set up the waveform that you want to test.
2. Create or load a mask. See:
 - ["To create and set up a mask"](#) on page 157
 - ["To load a mask"](#) on page 158
3. If necessary, tap "Setup" and adjust the y-position of the mask.
4. Set the "Actions" to be performed on violation.
5. In the mask window, tap "Run".

If the mask limits are violated, the specified action is taken. The overall result is shown in the mask window.

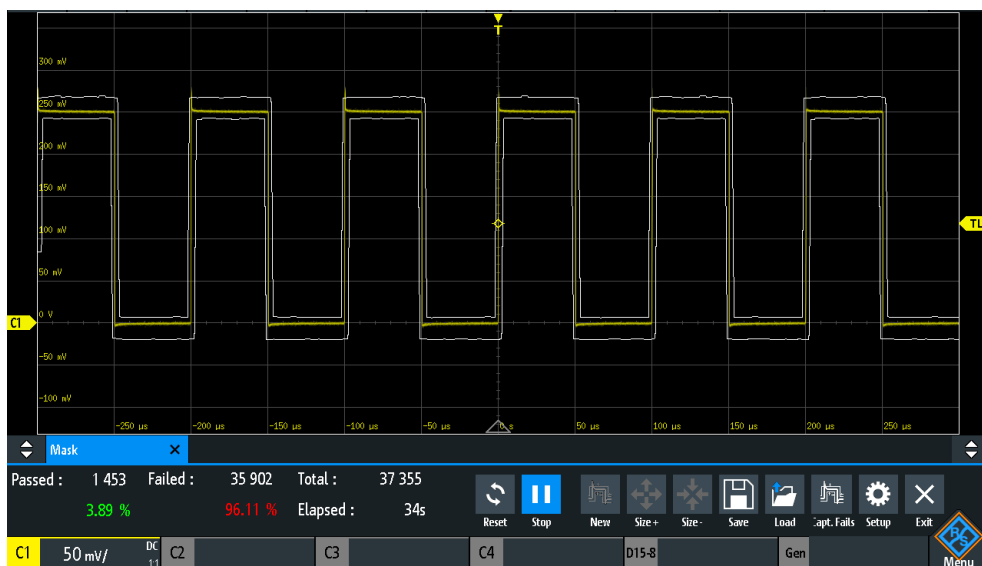

6. Tap "Reset" to delete the results.
7. To finish the test, tap "Stop".

8.1.3 Mask Window

The mask window provides the most important function to set up a mask, and to run the test.

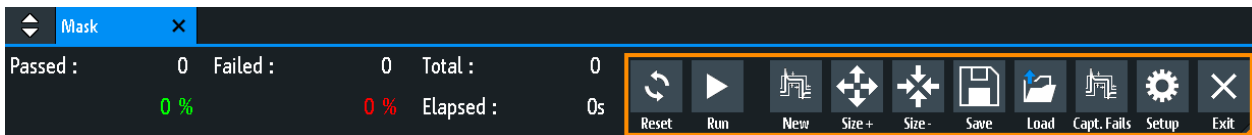

Reset

Deletes all test results.

Remote command:

[MASK:RESet:COUNter](#) on page 511

Run, Stop

Starts or finishes the mask test.

Remote command:

[MASK:TEST](#) on page 511

New

Creates a mask from the envelope of the selected channel waveform.

Remote command:

[MASK:SOURce](#) on page 507

[MASK:CHCopy](#) on page 508

Size+, Size-

Enlarges or decreases the mask in x- and y-direction.

Save, Load

Saves the created mask to file, or loads a previously saved mask. The file format is MSK.

Remote command:

[MASK:SAVE](#) on page 508

[MASK:LOAD](#) on page 509

Capt. Fails

If selected, only failed acquisitions are saved in memory segments.

Only available with history option R&S RTM-K15.

Remote command:

[MASK:CAPTURE\[:MODE\]](#) on page 512

Setup

Opens the "Setup" menu to define exact mask dimensions and the actions to be executed on violation of the mask.

8.1.4 Mask Menu

- ▶ To open the "Mask" setup menu:
 - Tap the "Setup" button in the mask window.
 - Tap the "Menu" icon. Select "Mask".



Test

Performs a mask test for the selected signal, i.e. the signal amplitudes are compared with the specified mask. If the amplitude exceeds the limits of the mask, a violation is detected.

Remote command:

[MASK:TEST](#) on page 511

Copy Channel

Creates a mask from the envelope waveform of the selected channel and stores it in the instrument.

Remote command:

[MASK:SOURce](#) on page 507

[MASK:CHCopy](#) on page 508

Y-Position

Moves the mask vertically within the display. The current position is given in divisions.

Remote command:

[MASK:YPOStion](#) on page 508

Stretch Y

Changes the vertical scaling to stretch or compress the mask in y-direction.

Remote command:

[MASK:YSCale](#) on page 508

Width X

Changes the width of the mask in horizontal direction. The specified factor in divisions is added to the positive x-values and subtracted from the negative x-values of the mask limits in relation to the mask center. Thus, the left half of the mask is pulled to the left, the right half is pulled to the right.

Remote command:

[MASK: XWIDTH](#) on page 508

Width Y

Changes the width of the mask in vertical direction. The specified number of divisions is added to the y-values of the upper mask limit and subtracted from the y-values of the lower mask limit. Thus, the upper half of the mask is pulled upwards, the lower half is pulled down, and the overall height of the mask is twice the "Width Y".

Remote command:

[MASK: YWIDTH](#) on page 508

Save

Saves the mask in an instrument-specific format (MSK). The complete mask definition - envelope waveform with width, stretch and position settings - is stored.

Remote command:

[MASK: SAVE](#) on page 508 and commands described in [Chapter 16.9.1.5, "Masks"](#), on page 547.

Load Mask

Opens a file explorer to select a previously stored mask. The selected mask is loaded and can be used for a subsequent test.

Remote command:

[MASK: LOAD](#) on page 509

Actions

Opens a submenu to select the actions to be taken when a violation against the mask limits occurs.

"Sound"	Generates a beep sound at each violation.
"Stop"	Stops the waveform acquisition. Set the number of the stop violation. Thus, you can ignore a number of violations before stop.
"Pulse"	Creates a pulse on the [Aux Out] connector. This selection sets the configuration of the [Aux Out] connector to "Mask Violation".
"Screenshot"	Saves a screenshot according to the settings in "File" > "Screenshots".
"Save Waveform"	Saves the waveform data according to the settings in "File" > "Waveforms".

Remote command:

[MASK: ACTION: SOUND: EVENT: MODE](#) on page 509

[MASK: ACTION: STOP: EVENT: MODE](#) on page 509

[MASK: ACTION: STOP: EVENT: COUNT](#) on page 510

[MASK: ACTION: PULSE: EVENT: MODE](#) on page 509

[MASK:ACTion:SCRSave:EVENT:MODE](#) on page 509

[MASK:ACTion:WFMSave:EVENT:MODE](#) on page 509

Capture Segments

Selects whether all acquisitions are stored in segments, or only failed acquisition. You can use the history to analyze the segments.

Only available with history option R&S RTM-K15.

Remote command:

[MASK:CAPTure\[:MODE\]](#) on page 512

8.2 FFT Analysis

The R&S RTM3000 provides basic FFT calculation, which is included in the firmware.

During FFT analysis, a time-based waveform is converted to a spectrum of frequencies. As a result, the magnitude of the determined frequencies is displayed: the power vs. frequency diagram (spectrum). FFT results are useful to obtain an overview of the input signal in the frequency domain and to detect unusual signal effects (such as spurs or distortions) visually.

To enable FFT analysis

- ▶ Press the [FFT] key.
Alternatively, tap the "FFT" icon in the toolbar.

The instrument adjusts the time scale of the waveform and sets appropriate center frequency and span.

To disable FFT analysis

- ▶ There are several ways to exit FFT analysis:
 - Press the [FFT] key repeatedly until FFT is off.
 - Tap the "FFT" icon in the toolbar.
 - In the short menu, tap "FFT Off".

8.2.1 FFT Display

When FFT is active, two diagrams are displayed: the signal vs. time at the top, the result of the FFT analysis at the bottom. Between the diagrams, FFT-specific parameters are shown and can be set directly.



- 1 = Enable FFT
- 2 = Signal vs. time display
- 3 = FFT parameters
- 4 = Spectrum, result of the FFT analysis
- 5 = FFT label with vertical scale (range per division). Color indicates the source waveform of FFT calculation.

Data source

FFT analysis is performed on the data captured from one of the active input channels, or one of the active math or reference waveforms. Analysis can only be performed on one channel at a time.

Timebase

FFT is generally performed on the captured data of a complete acquisition. To reduce calculation time, the instrument automatically sets the time scale and an extract of the original timebase for which the FFT is to be performed. The time gate is indicated by white lines in the time diagram.

Frequency range

The results of the FFT analysis can be restricted to a specified frequency range. Therefore, you define a center frequency and a frequency span, or the start and stop frequencies. Alternatively, you can manually set the resolution bandwidth. When you change the FFT parameters, the time gate on the waveform is adapted automatically.

Vertical position and size of the FFT waveform

To set the position and the vertical scaling, select the FFT window and use the vertical [Scale] and [Offset/Position] knobs.

Remote commands:

- `SPECTrum:FREQuency:SCALE` on page 514
- `SPECTrum:FREQuency:POSition` on page 514

Zoom

You can use the vertical zoom ("Zoom" icon on the toolbar) on the FFT waveform. If you draw the zoom area in the FFT diagram, center, span and vertical scale are adjusted, and the zoomed section of the FFT is displayed in the FFT diagram.

8.2.2 Performing FFT Analysis

1. Press the [FFT] key to start FFT analysis.
2. Press the [FFT] key again to open the FFT menu.
3. Select the "FFT Window" type according to the signal characteristics that are most relevant for your measurement task (see "FFT Window" on page 168).
4. In the "Waveform" menu, select the waveform types you want to display (see "Waveform" on page 169).
5. If you want to adjust the resolution bandwidth manually, disable "Automatic RBW".
6. On top of the FFT window, define the timebase extract for which the spectrum is calculated and displayed. The extract is defined by its width and position, or by the resolution bandwidth.
 - a) Press "W" to define the width of the timebase extract.
 - b) Press "P" to define the position of the timebase extract. The position is an offset of the center of the extract range to the 0 s reference point.
7. On top of the FFT window, define the frequency range to be displayed in the spectrum window. The range is defined as $(\text{Center} - \text{Span}/2)$ to $(\text{Center} + \text{Span}/2)$. For details, see [Span](#) and [Center](#).
 - a) Press "Span" to define the width of the frequency range.
 - b) Press "Center" to define the center frequency of the range.
8. To start and stop FFT analysis, press the [Run Stop] key.

8.2.3 FFT Setup

You can set the parameters for the FFT analysis in the spectrum window and in the FFT menu. In addition, the short menu provides frequently used settings.

8.2.3.1 Short Menu for FFT

Frequently used settings are available in the short menu. You can select the waveform type, set full span, open the comprehensive menu and disable the FFT analysis.

- ▶ To open the short menu, tap the FFT label in the bottom line of the display. The label is only available, if the FFT analysis is active.

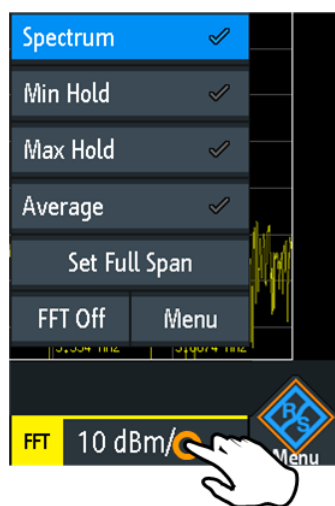

8.2.3.2 Settings in the FFT Window

Typical FFT parameters can be set directly in the FFT window, above the diagram.



- 1 = Start frequency
- 2 = Stop frequency
- 3 = Center
- 4 = Span
- 5 = Resolution bandwidth (RBW)
- 6 = Width of the timebase extract
- 7 = Position of timebase extract

Start

Defines the start frequency of the FFT waveform. The instrument adjusts the span and the center frequency, and optimizes the timebase extract.

Remote command:

[SPECTrum:FREQUENCY:START](#) on page 515

Stop

Defines the stop frequency of the displayed frequency span. The instrument adjusts the span and the center frequency, and optimizes the timebase extract.

Remote command:

[SPECTrum:FREQuency:STOP](#) on page 515

Center

Defines the frequency in the center of the displayed span. The instrument adjusts the start and stop frequencies.

To set the center frequency, you can also use the horizontal [Position] knob if the focus is on the frequency window.

Remote command:

[SPECTrum:FREQuency:CENTer](#) on page 514

Span

The span is specified in Hertz and defines the width of the displayed frequency range, which is $(\text{Center} - \text{Span}/2)$ to $(\text{Center} + \text{Span}/2)$. The instrument adjusts the start and stop frequencies.

To set the frequency span, you can also use the horizontal [Scale] knob if the focus is on the frequency window.

Remote command:

[SPECTrum:FREQuency:SPAN](#) on page 515

RBW

The resolution bandwidth (RBW) determines the resolution of the spectrum, that is: the minimum distance between two distinguishable peaks. The higher the resolution (the smaller the ratio), the more peaks are detected, but the longer the measurement requires to finish.

If "Automatic RBW" is selected, the RBW value is adjusted automatically and the value is shown for information. when you set the RBW manually, the instrument adjusts the timebase extract.

Remote command:

[SPECTrum:FREQuency:BANDwidth\[:RESolution\]\[:VALue\]](#) on page 515

[SPECTrum:FREQuency:BANDwidth\[:RESolution\]:RATio](#) on page 515

W

Shows the width of the timebase extract (gate) for which FFT is calculated.

Remote command:

[SPECTrum:TIME:RANGe](#) on page 516

P

Shows the position of timebase extract (gate) to restrict the timebase of the input signal for which FFT analysis is performed.

Remote command:

[SPECTrum:TIME:POSition](#) on page 516

8.2.3.3 FFT Menu

- ▶ Press the [FFT] key.
If the menu does not open, tap twice: Once to enable FFT, and next to open the menu.



Source

Selects the channel for which the captured data is analyzed with FFT. You can select one of the active input channels, math or reference waveforms.

Remote command:

[SPECTrum: SOURce](#) on page 513

FFT Window

Windowing helps minimize the discontinuities at the end of the measured signal interval and thus reduces the effect of spectral leakage, increasing the frequency resolution.

The R&S RTM3000 provides various window functions to suit different input signals. Each window function has specific characteristics, including some advantages and some trade-offs. Consider these characteristics to find the optimum solution for the measurement task.

- | | |
|-----------|---|
| "Hanning" | The Hanning window is bell shaped. Unlike the Hamming window, its value is zero at the borders of the measuring interval. Thus, the noise level within the spectrum is reduced and the width of the spectral lines enlarges.
Use this window to measure amplitudes of a periodical signal precisely. |
| "Hamming" | The Hamming window is bell shaped. Its value is not zero at the borders of the measuring interval. Thus, the noise level inside the spectrum is higher than Hanning or Blackman, but smaller than the rectangular window. The width of the spectral lines is thinner than the other bell-shaped functions.
Use this window to measure amplitudes of a periodical signal precisely. |

"Blackman"	<p>The Blackman window is bell shaped and has the steepest fall in its wave shape of all other available functions. Its value is zero at both borders of the measuring interval. In the Blackman window, the amplitudes can be measured very precisely. However, determining the frequency is more difficult.</p> <p>Use this window to measure signals with single frequencies to detect harmonics and accurate single-tone measurements.</p>
"Flat Top"	<p>The flat top window has low amplitude measurement errors but a poor frequency resolution.</p> <p>Use this window for accurate single-tone measurements and for measurement of amplitudes of sinusoidal frequency components.</p>
"Rectangle"	<p>The rectangular window multiplies all points by one. The result is a high frequency accuracy with thin spectral lines, but also with increased noise.</p> <p>Use this function for measurements of separation of two tones with almost equal amplitudes and a small frequency distance.</p>

Remote command:

[SPECTrum:FREQUENCY:WINDow:TYPE](#) on page 513

Automatic RBW

If enabled, the resolution bandwidth is set automatically. If disabled, you can adjust the "RBW" parameter in the FFT window.

See also: ["RBW"](#) on page 167.

Waveform

Selects the waveform type to be displayed. Several types of waveforms can be displayed in parallel, but at least one waveform type must be selected. By default, the "Spectrum" waveform is selected. From each waveform type, you can also create a reference waveform for further analysis, and perform cursor measurements.

When the waveform selection is changed, statistical evaluation is restarted.

To clear the results of previous measurements used for statistical evaluation, select "Reset".

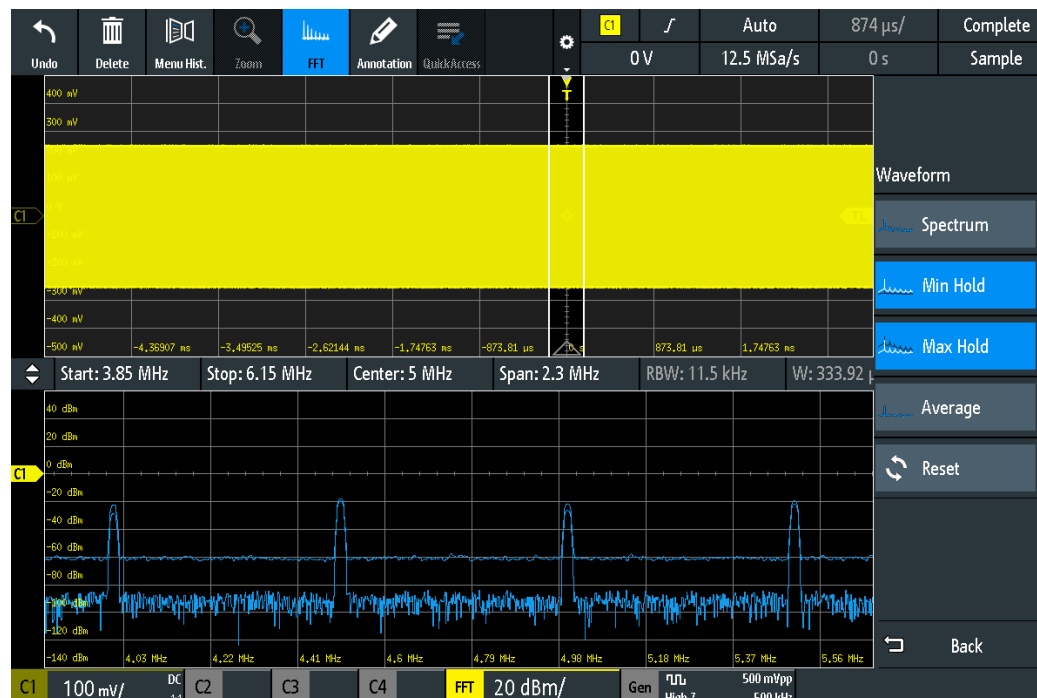

"Spectrum"

The current value for each frequency is displayed.

"Min Hold"

The minimum value for each frequency over all FFTs is displayed. Using the "Min Hold" waveform type is a good way to highlight signals within noise or suppress intermittent signals.

"Max Hold"

The maximum value for each frequency over all FFTs is displayed. Using the "Max Hold" waveform type is a good way to detect intermittent signals or the maximum values of fluctuating signals, for example.

"Average"

The average value for each frequency in the waveform over the specified "# Averages" is calculated. Averaging reduces the effects of noise, but has no effects on sine signals. Therefore, averaging is a good way to detect signals near noise.

"Reset"

Clears the selected waveforms and restarts calculation.

Remote command:

[SPECTrum:WAVEform:SPECTrum\[:ENABLE\]](#) on page 516

[SPECTrum:WAVEform:MINimum\[:ENABLE\]](#) on page 516

[SPECTrum:WAVEform:MAXimum\[:ENABLE\]](#) on page 516

[SPECTrum:WAVEform:AVERage\[:ENABLE\]](#) on page 516

[SPECTrum:FREQUENCY:AVERage:COUNT](#) on page 516

[SPECTrum:FREQUENCY:RESet](#) on page 517

Vertical Scale

Defines the scaling unit for the vertical scale.

The displayed values refer to a 50 Ohm terminating resistor. You can use an external terminating resistor parallel to the high impedance input, or the 50 Ohm input directly.

"dBm"

Logarithmic scaling; related to 1 mW

"dBV"	Logarithmic scaling; related to 1 V _{eff} .
"dB μ V"	Logarithmic scaling; related to 1 μ V _{eff} .
"V _{eff} "	Linear scaling; displays the RMS value of the voltage.

Remote command:

[SPECTrum:FREQuency:MAGNitude:SCALE](#) on page 513

8.3 Spectrum Analysis and Spectrogram (Option R&S RTM-K18)

The option R&S RTM-K18 offers additional functionalities to the basic FFT calculation:

- Spectrum mode
- Spectrogram
- Peak list and markers

Using the spectrum analysis option, you can analyze frequency-dependent events and display a spectrogram that shows the changes of the spectrum over time. Also you can define various criteria for peak search and display the results on the spectrum diagram.

The initial FFT display, usage, short menu, and FFT settings in the spectrum window are the same as in the basic FFT. These basics are described in [Chapter 8.2, "FFT Analysis"](#), on page 163.

8.3.1 FFT Menu with R&S RTM-K18

If option R&S RTM-K18 is installed, the FFT menu provides additional functions, which are described in this chapter. Basic functions are described in [Chapter 8.2.3.3, "FFT Menu"](#), on page 168.

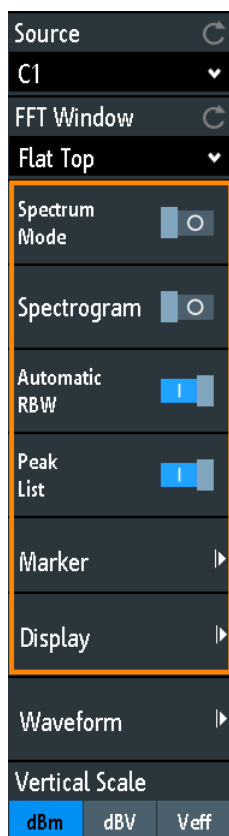

Spectrum Mode

Enables the spectrum mode.

For details, see [Chapter 8.3.2, "Spectrum Mode"](#), on page 173.

Spectrogram

Enables the spectrogram.

For details, see [Chapter 8.3.3, "Spectrogram"](#), on page 174.

Remote command:

`SPECTrum:DIAGram:SPECTrogram[:ENABLE]` on page 527

Automatic RBW

If enabled, the instrument sets an appropriate value for the resolution bandwidth. If disabled, you can set a manual value, see ["RBW"](#) on page 167.

Remote command:

`SPECTrum:FREQuency:BANDwidth[:RESolution]:AUTO` on page 526

Peak List

Enables the peak search, and displays the peak list and the markers.

For details, see [Chapter 8.3.4, "Peak List and Markers"](#), on page 175.

Remote command:

`SPECTrum:MARKer:RTABLE:ENABLE` on page 520

Marker

Opens a menu to set up the markers and the peak list. The menu is only available if "Peak List" is active.

For details, see [Chapter 8.3.4, "Peak List and Markers"](#), on page 175.

Display

Opens a menu to set up the display of the spectrum and the spectrogram.

For details, see [Chapter 8.3.5, "Display Settings for Spectrum and Spectrogram"](#), on page 181.

8.3.2 Spectrum Mode

The option R&S RTM-K18 supports a dedicated spectrum mode.

The spectrum mode increases the dynamic range and the update rate. In spectrum mode, no time-based waveform is acquired for the channel of the spectrum source. Thus, all analysis is done on the spectrum waveform.

In spectrum mode, the manual and remote operations are the same as with deactivated spectrum mode (normal FFT analysis).

- To use the spectrum mode, enable "Spectrum Mode" in the FFT menu.

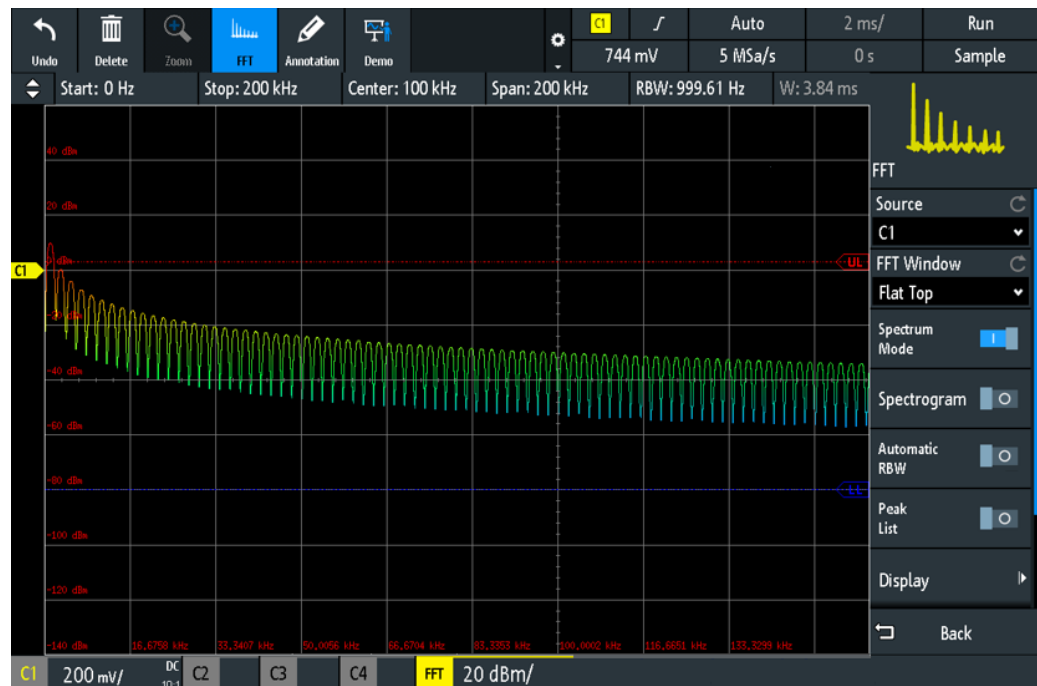

Figure 8-1: FFT display in spectrum mode

8.3.3 Spectrogram

A spectrogram shows how the spectral density of a signal varies over time. The x-axis shows the frequency, the y-axis shows the time. A third dimension, the power level, is indicated by different colors. Thus you can see how the strength of the signal varies over time for different frequencies.

The spectrogram is updated with each data acquisition. The oldest spectrum is on the top, while the most recent spectrum is the bottom line.

The spectrogram is available with and without spectrum mode.

- To use the spectrogram, enable "Spectrogram" in the FFT menu.

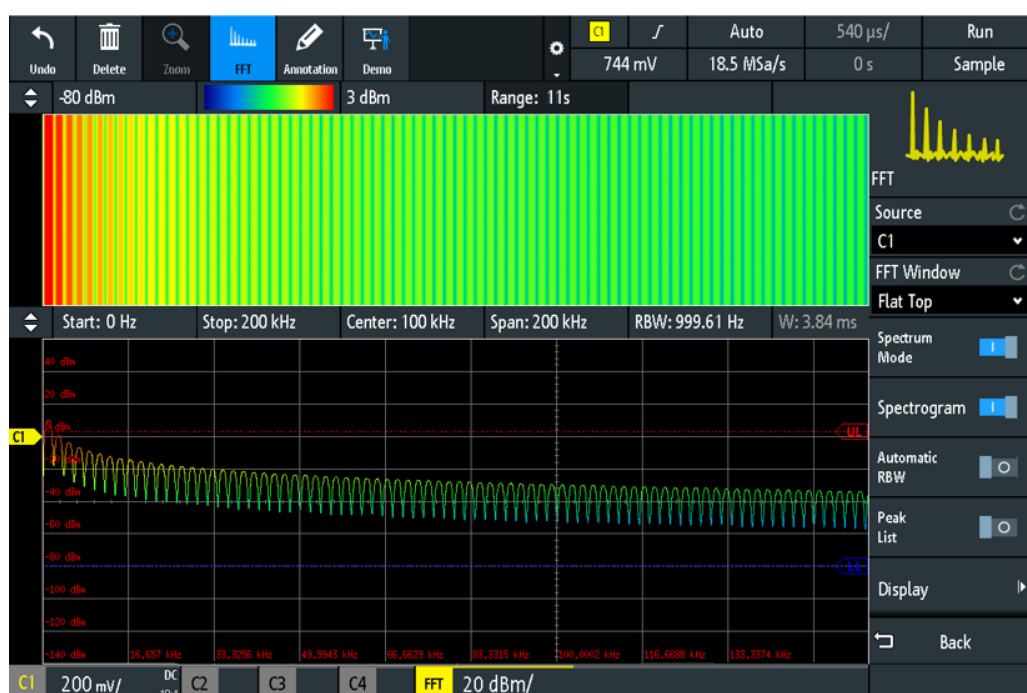

Figure 8-2: Spectrogram and spectrum windows

The spectrogram is shown in a separate window above the spectrum window. Typical spectrogram parameters are shown directly in the spectrogram window, above the diagram.



- 1 = Maximum level for color scale (setting)
- 2 = Display of color scale
- 3 = Minimum level for color scale (setting)
- 4 = Range (information)
- 5, 6, 7 = Positions of the time cursors in the spectrogram, and their time difference

Time cursors

When acquisition is stopped, you can set two time cursors in the spectrogram. Use the time cursors to identify abnormalities in the spectrogram. The time and time difference are displayed on top of the spectrogram window.

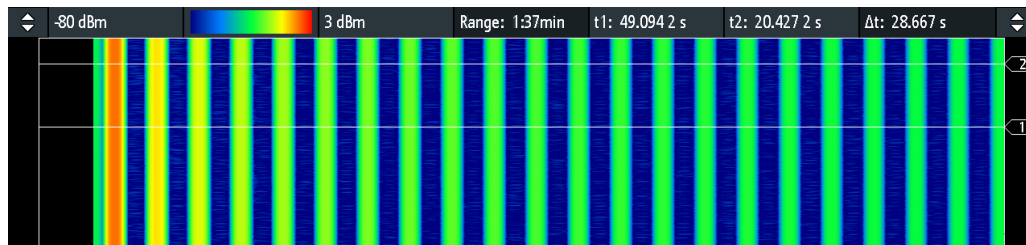

Figure 8-3: Spectrogram with time cursors

History and spectrum analysis

The history function allows you to browse the spectrums. You can display and analyze not only the current frequency waveform but also older ones. If the spectrum mode is disabled, you can also see and analyze the time-based waveform on which the selected FFT was done. The displayed spectrum is marked in the spectrogram by a white line with "Seg" label.

Using the history and segmented memory requires option R&S RTM-K15.

1. Run an FFT.
2. Enable the spectrogram.
3. Disable the spectrum mode.
4. Activate the history.
Acquisition is stopped, and the time cursors and the segment cursor are visible. If they are not visible, close all menus.
5. Select a segment:
 - Use the history player to browse and select a segment, see [Chapter 6.4.4, "Segment Table and History Player"](#), on page 116.
 - Drag the segment marker in the spectrogram.

The spectrum and time-based waveform of the selected segment are displayed.

8.3.4 Peak List and Markers

You can define various criteria for a peak search. The peaks are indicated in the frequency diagram by markers, and the measured peak frequencies and magnitudes are listed in the peak list. In addition, you can define a reference marker and get the peak results as delta values to the values of the reference marker.

Peak list and markers are available with and without spectrum mode.

Spectrum Analysis and Spectrogram (Option R&S RTM-K18)

- ▶ To save the results, or to open the "Marker" menu directly, use the icons on the right side of the peak list.

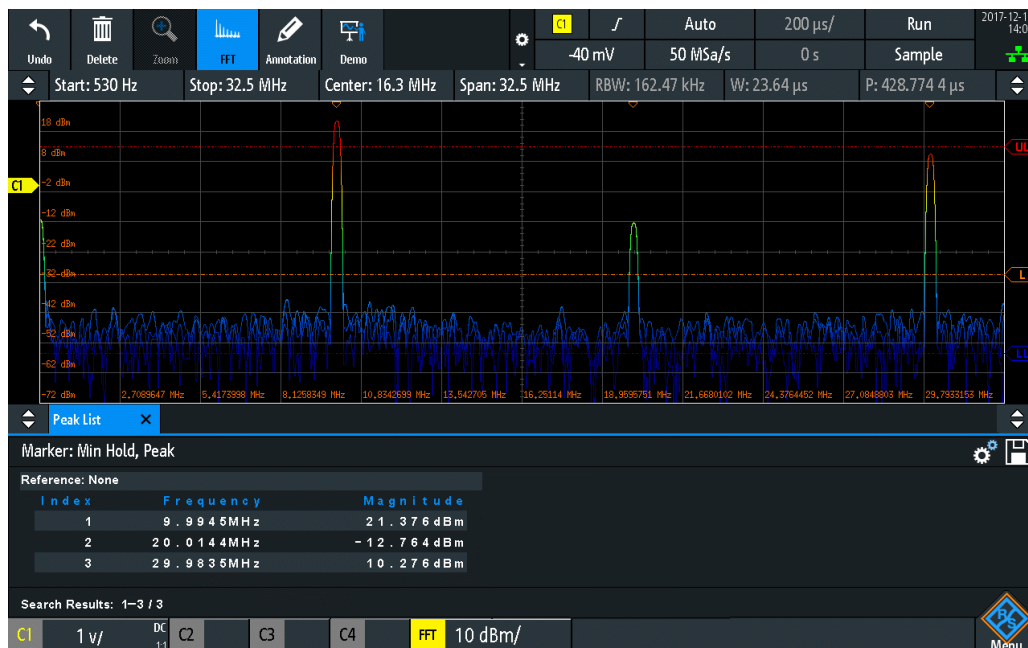

Figure 8-4: Spectrum with marked peaks and peak list. Spectrogram is off.

To set up the peak list and reference markers

1. Open the FFT menu.
2. Enable the "Peak List".
3. Tap "Marker".
4. Tap "Source".
Select the waveform type on which the peaks are searched.
5. Tap "Peak Setup".
6. Define the criteria for peak detection:
 - a) Set the "Min. Level". Magnitudes higher than this level are marked as peaks.
 - b) For a more detailed peak detection, enable the "Advanced Peak Setup".
Set the "Excursion", "Max. Width" and "Distance".
7. If necessary, set a reference marker:
 - a) Select the type of the "R-Marker".
 - b) If "R-Marker" = "Indicated", set the "Index".
 - c) If "R-Marker" = "Range", set the "Frequency" and "Span".

8.3.4.1 Marker Menu

Access: "FFT" menu > enable "Peak List" > "Marker"

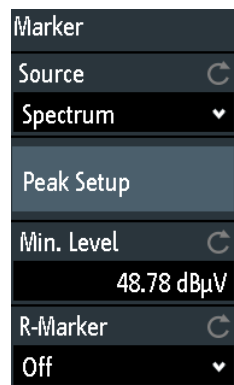
**Source**

Defines the waveform type that is searched for peaks.

Remote command:

[SPECTrum:MARKer:SOURce](#) on page 521

Peak Setup

See [Chapter 8.3.4.2, "Peak Setup"](#), on page 177.

Min. Level

Defines the minimum absolute level for peak detection. See ["Min. Level"](#) on page 178.

R-Marker

See [Chapter 8.3.4.3, "R-Marker Settings"](#), on page 179.

8.3.4.2 Peak Setup

Access: "FFT" menu > enable "Peak List" > "Marker" > "Peak Setup"

The simple peak setup needs only the setting of the minimum level for peak detection. More complex criteria can be defined in the advanced setup.

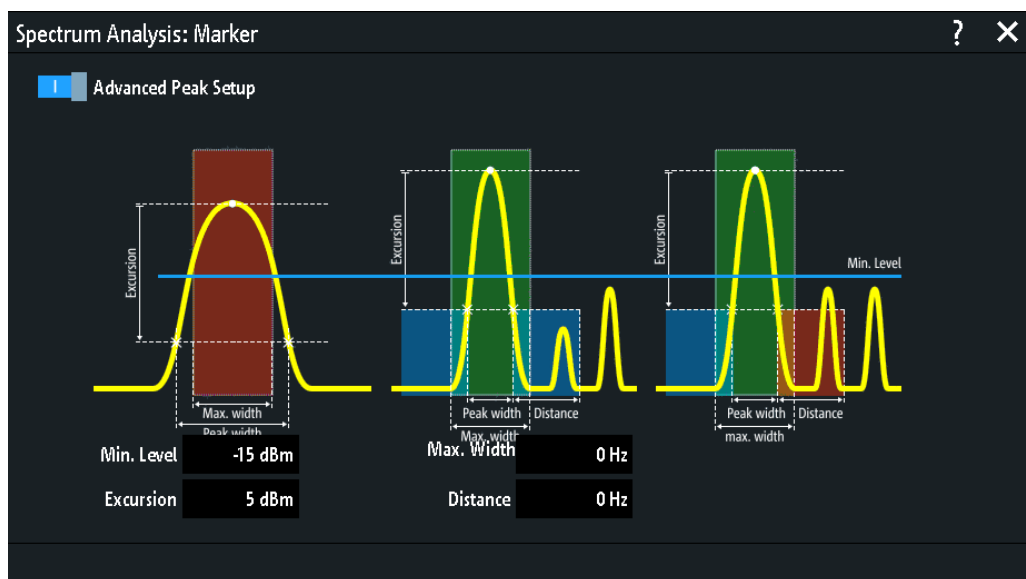

Min. Level

Defines the minimum absolute level for peak detection. Only peaks that exceed the minimum level are detected, listed in the "Peak List", and marked in the spectrum diagram.

Remote command:

[SPECTrum:MARKer:SETup:MLEvel](#) on page 521

Advanced Peak Setup

Enables a more precise peak detection.

For a peak to be detected, the [Excursion](#), [Max. Width](#) and [Distance](#) have to be within the defined limits.

Remote command:

[SPECTrum:MARKer:SETup:MMODE](#) on page 521

Max. Width

Defines the maximum width that a peak can have for it to be detected.

Remote command:

[SPECTrum:MARKer:SETup:MWIDth](#) on page 522

Excursion

Defines a minimum level difference between two subsequent peaks that has to be kept for the peak to be detected. To avoid identifying noise peaks, enter a peak excursion value that is higher than the noise levels.

Remote command:

[SPECTrum:MARKer:SETup:EXCursion](#) on page 521

Distance

Defines a distance between two subsequent peaks that has to be kept for the peak to be detected.

Remote command:

[SPECTrum:MARKer:SETup:DIStance](#) on page 521

8.3.4.3 R-Marker Settings

Access: "FFT" menu > enable "Peak List" > "Marker" > "R-Marker"

You can define a reference marker and get the peak results as delta values to the values of the reference marker. The reference marker is displayed on the waveform as a filled orange triangle.

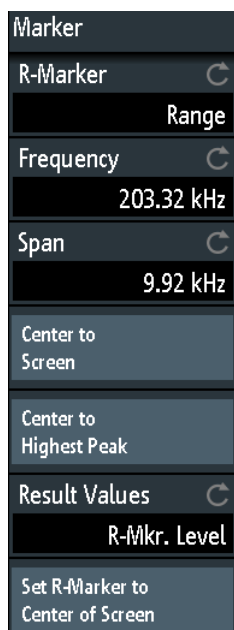

R-Marker

Defines the mode for the selection of the reference peak.

- "Off" Disables the reference marker.
- "Indicated" The reference marker is set to the peak with a specified index number.
- "Range" The peak with the highest level within the specified range is set as the reference marker.

Remote command:

[SPECTrum:MARKer:REFerence:SETup:MODE](#) on page 522

Index

Defines the number of the peak to which the reference marker is set if "R-Marker" = "Indicated"

Remote command:

[SPECTrum:MARKer:REFerence:SETup:INDEX](#) on page 522

Frequency

Defines the center frequency for the capture range if "R-Marker" = "Range".

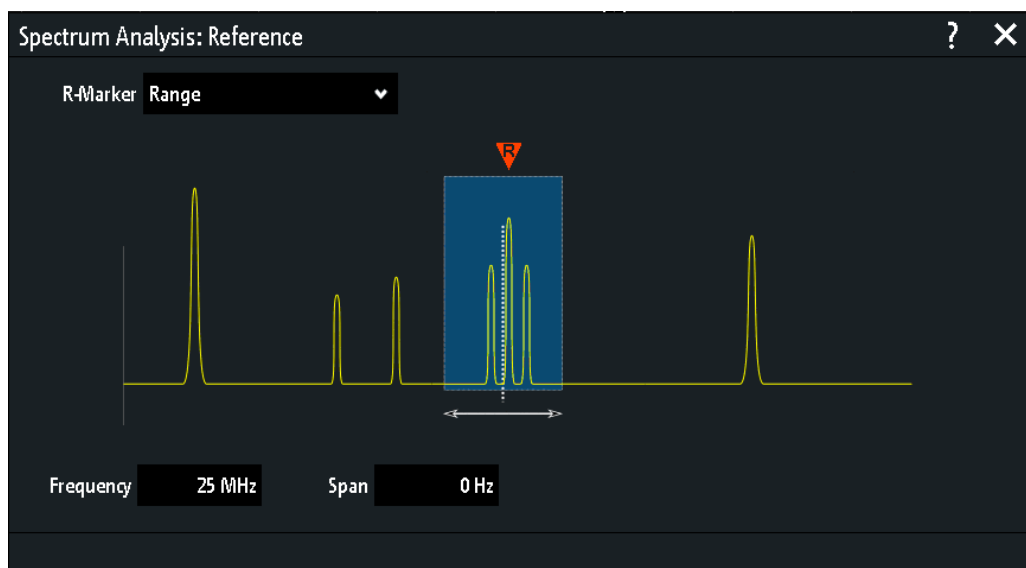

Remote command:

[SPECTrum:MARKer:REFerence:SETup:FREQuency](#) on page 523

Span

Defines frequency range around the center frequency if "R-Marker" = "Range".

Remote command:

[SPECTrum:MARKer:REFerence:SETup:SPAN](#) on page 523

Center to Screen

Sets the center frequency to the center of the display.

Remote command:

[SPECTrum:MARKer:REFerence:SETup:CSCreen](#) on page 522

Center to Highest Peak

Sets the highest detected peak to the center of the display.

Remote command:

[SPECTrum:MARKer:REFerence:SETup:CMPeak](#) on page 522

Result Values

Defines the values that are shown in the peak list. You can use absolute values, or delta values in comparison to the reference marker.

"Absolute" Frequency and magnitude in absolute values.

"R-Marker Frequency"

Frequency relative to the reference marker frequency, magnitude in absolute values.

"R-Marker Level"

Frequency in absolute values, magnitude relative to the level of the reference marker.

"R-Marker Freq. & Level"

Frequency and magnitude relative to the reference marker values.

Remote command:

[SPECTrum:MARKer:RMODE](#) on page 523

Set R-Marker to Center of Screen

Sets the reference marker to the center of the display.

8.3.5 Display Settings for Spectrum and Spectrogram

You can change the color scale of the spectrogram and of the spectrum, and the level limits of the spectrogram.

1. Open the "FFT" menu.
2. Tap "Display".

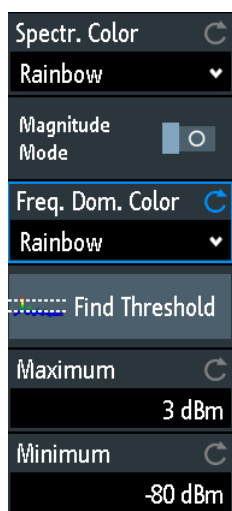

Spectr. Color and Freq.Dom.Color

Selects a color scale. Each scale comprises a set of colors, where each color represents a certain level or frequency of occurrence.

If "Magnitude Mode" is on, "Spectr. Color" sets the color scale for the spectrogram and for the spectrum. Both diagrams use the same color scale.

If "Magnitude Mode" is off, "Spectr. Color" sets the color for the spectrogram, and "Freq.Dom.Color" sets the color for the spectrum separately.

You can set the range of the color scale with [Maximum](#) and [Minimum](#).

"Rainbow"



The waveform is displayed in rainbow colors. Blue corresponds to the low-level values while red indicates high ones.

"Temp. Color"



The waveform is displayed in the temperature colors. Blue corresponds to the low-level values while white indicates high ones.

"Monochrome" 

The waveform is displayed in monochrome colors, which depend on the color of the selected source channel. Black corresponds to the low-level values while the channel color indicates for high ones.

Remote command:

[SPECTrum:DIAGram:COLor:SCHeme:SPECTrogram](#) on page 527

[SPECTrum:DIAGram:COLor:SCHeme:FDOMain](#) on page 527

Magnitude Mode

Enables the magnitude-dependent coloring of the waveform. The higher the level, the higher the color in the color scale.

When the "Magnitude Mode" is disabled, then the color depends on the frequency of occurrence of a value.

Remote command:

[SPECTrum:DIAGram:COLor:MAGNitude:MODE](#) on page 526

Find Threshold

Sets the level automatically to $0.5 * (MaxPeak - MinPeak)$. The *MinPeak* is set in the noise floor and the *MaxPeak* is the highest point of the waveform.

Maximum

Sets the level that is used as a maximum for the color scale selected with [Spectr. Color and Freq.Dom.Color](#).

All level values higher than the maximum are displayed with the maximum color.

Remote command:

[SPECTrum:DIAGram:COLor:MAXimum\[:LEVel\]](#) on page 527

Minimum

Sets the level that is used as a minimum of the color scale selected with [Spectr. Color and Freq.Dom.Color](#).

All level values lower than the minimum are displayed with the minimum color.

Remote command:

[SPECTrum:DIAGram:COLor:MINimum\[:LEVel\]](#) on page 527

8.4 XY-Diagram

XY-diagrams combine the voltage levels of two waveforms in one diagram. They use the amplitude of a second waveform as the x-axis, rather than a timebase. Thus, you can measure phase shift, for example. With harmonically related signals, the resulting XY-diagrams are Lissajous patterns. XY-diagrams can also be used to display the IQ representation of a signal.

Together with the XY-diagram, the time diagrams of the source signals are displayed in separate grids. It is also possible to define two source signals in y-direction for comparison.

1. Press the  [Apps Selection] key.
2. Select "XY".
3. Make sure that the signals, the trigger, and the acquisition are set up correctly. The required menus are available in XY-mode.

Remote command: [DISPlay:MODE](#) on page 528

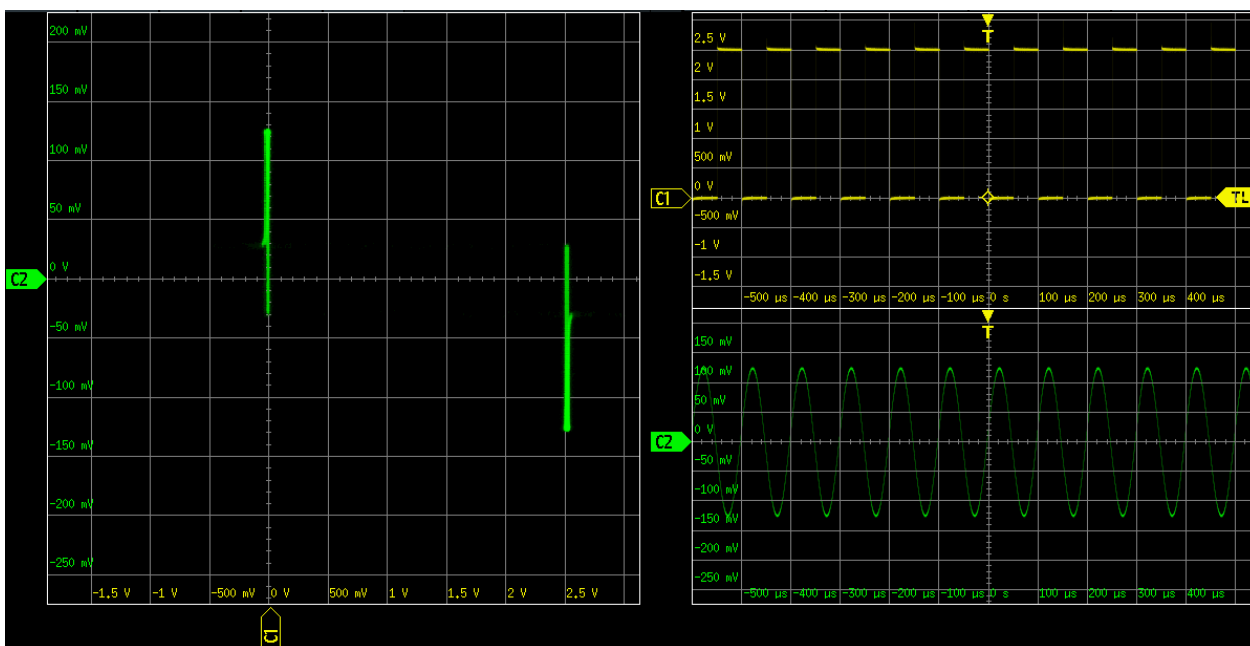

To analyze the signal in the XY-diagram, you can use cursor measurements. You can select specific cursor measurement types: "Voltage X", "Voltage Y1", "Voltage Y2" use 2 cursor lines, "Voltage X-Y1" and "Voltage X-Y2" use 4 cursor lines.

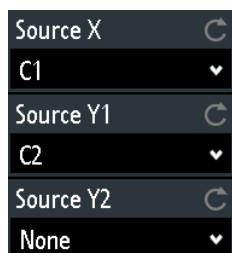

Source X

Defines the source to be displayed in x-direction in an XY-diagram, replacing the usual timebase. The source can be any of the analog channels.

Remote command:

[DISPlay:XY:XSource](#) on page 528

Source Y1

Defines the first signal to be displayed in y-direction in an XY-diagram. The source can be any of the active analog channels.

Remote command:

`DISPlay:XY:Y1Source` on page 528

Source Y2

Defines an optional second source to be displayed in y-direction in an XY-diagram. The source can be any of the analog channels. The setting is only relevant for 4-channel R&S RTM3000 instruments.

Remote command:

`DISPlay:XY:Y2Source` on page 528

8.5 Digital Voltmeter

The integrated three-digit digital voltmeter simplifies measurements, in particular for service personnel. You can measure up to four parameters on different sources at the same time and define the position of the measurement results.

The following DVM measurements are available:

- DC: mean value of the signal
- AC+DC RMS: RMS value of the signal
- AC RMS: RMS value of the signal's AC component

The digital voltmeter captures input data with the selected vertical sensitivity and the basic accuracy of the ADC. It is independent from the capture settings and the post processing. All measurements are based on a measurement interval, which ensures reliable results over the defined frequency range.

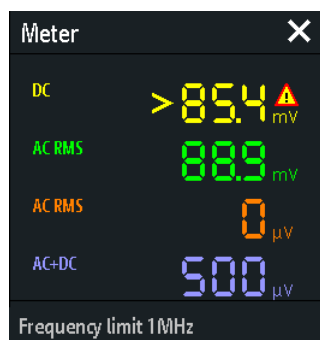

Figure 8-5: Results of 4 meter measurements. The measurement source is indicated by the channel color. The source of meter 1 is channel 1, and it is clipped.

Remote commands to read meter results:

- `DVM<m>:RESult[:ACTual]?` on page 529
- `DVM<m>:RESult[:ACTual]:STATus?` on page 530

8.5.1 Using the Meter

To activate meter measurements

► Use one of the following ways:

- Tap the "Meter" icon on the toolbar.



- Press the  [Apps Selection] key. Tap "Meter".

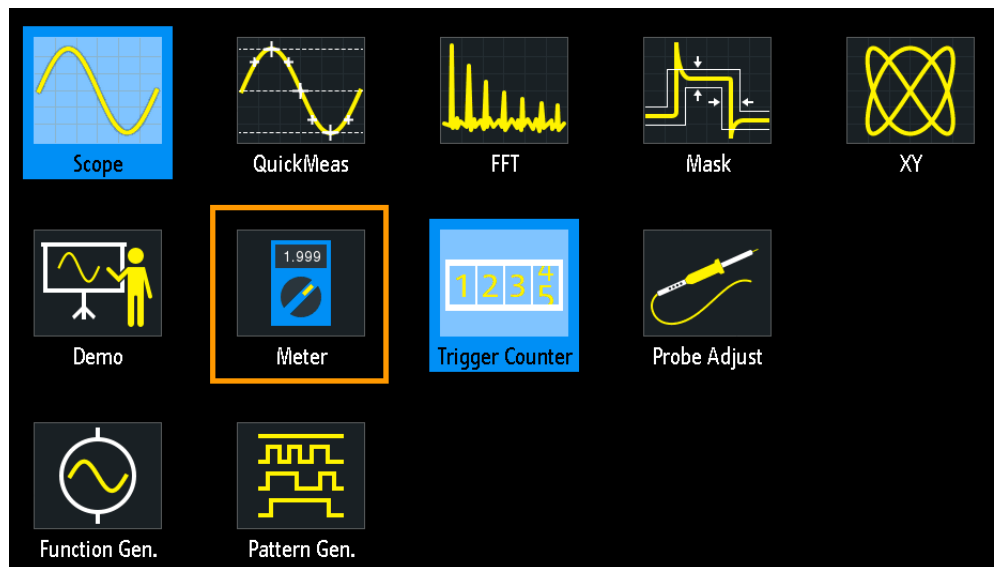

To deactivate meter measurements

► Use one of the following ways:

- Tap the "Meter" icon on the toolbar again.
- Close the "Meter" result box.

8.5.2 Meter Settings

► To open the "Meter" configuration menu, tap inside the "Meter" result box.

**Meter (on/off)**

Activates or deactivates the digital voltmeter with the last configuration. Preset deletes the voltmeter configuration.

Remote command:

[DVM<m>:ENABLe](#) on page 529

Meter

Selects one of the four available meter measurements. The configuration of the selected meter is displayed in the menu.

Source

Selects an analog channel as the source of the selected meter measurement.

Remote command:

[DVM<m>:SOURce](#) on page 529

Type

Defines the measurement type to be performed on the selected source:

- DC: mean value of the signal
- AC+DC RMS: RMS value of the signal
- AC RMS: RMS value of the signal's AC component

Select "Off" to disable the selected meter measurement.

Remote command:

[DVM<m>:TYPE](#) on page 529

8.6 Trigger Counter

The counter shows two basic parameters of the trigger source: frequency and period.

1. Press the  [Apps Selection] key.
2. Tap "Trigger Counter".

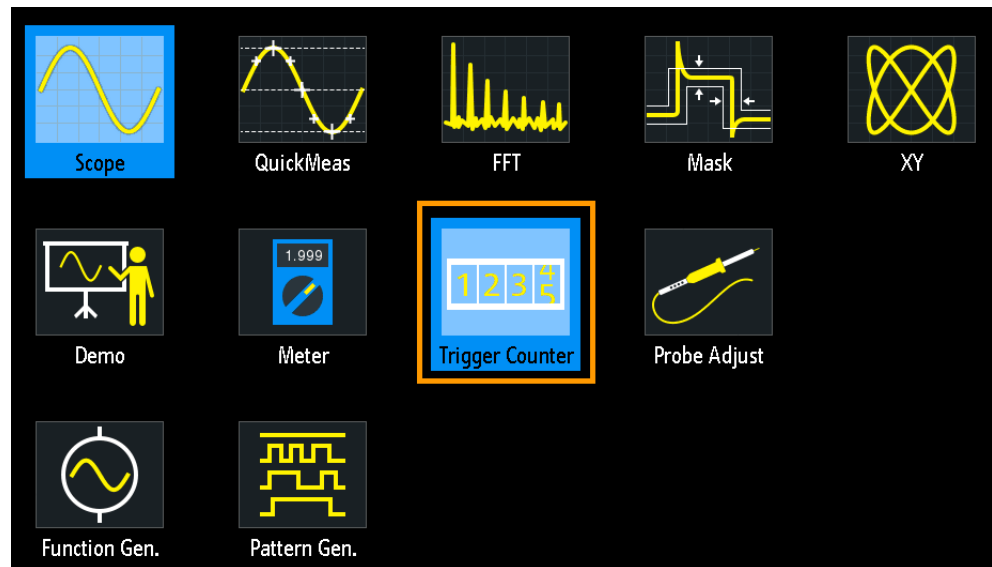

By default, the result box shows the frequency and period of the trigger source.

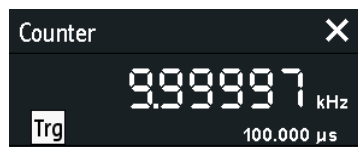

1. To toggle frequency and period results, tap inside the box.
2. To show the counter results of active waveforms, tap the source icon ("Trg") and select a waveform.
3. To move the result box to the best position, can drag the box on the screen.

Remote commands:

- [TCOUNTER:ENABLE](#) on page 531
- [TCOUNTER:SOURCE](#) on page 531
- [TCOUNTER:RESULT\[:ACTUAL\]:FREQUENCY?](#) on page 531
- [TCOUNTER:RESULT\[:ACTUAL\]:PERIOD?](#) on page 531

8.7 Bode Plot (Option R&S RTM-K36)

A Bode plot displays the frequency response of an electrical system. It is divided in two parts, a magnitude plot and a phase shift plot.

8.7.1 About the Bode Plot

Bode Plot Display

The Bode plot display is divided into several sections, see [fig. 8-6](#).



Figure 8-6: Bode plot display

- 1 = Bode plot parameters
- 2 = Bode plot diagram, gain: blue color; phase: orange color
- 3 = Save
- 4 = Bode result table
- 5 = Marker value table
- 6 = Bode plot window controls
- 7 = Vertical settings of active analog channels
- 8 = Vertical settings of gain waveform
- 9 = Vertical settings of phase waveform

Bode plot diagram

The Bode plot diagram has the frequency presented on the x-axis. The gain (blue color waveform) and phase (orange color waveform) scales are on the y-axis. The magnitude plot represents the gain of a system between input and output. The phase plot shows the phase shift between input and output.

Bode plot result table

In the Bode plot result table, all sample points are displayed with the respective value for the frequency, gain, phase and amplitude. If you select a sample in the table, the respective points in the Bode plot are highlighted by a white line on the gain and the phase curve.

Marker value table

There are two markers available for the Bode plot. They are highlighted on the Bode plot diagram by a white line and the respective marker number 1 or 2. You can move the markers as needed.

In the marker table you can see the frequency, gain and phase values for both of them and also the delta values between the two markers.

Remote commands:

- `BPLot:MARKer<m>:DIFFerence:FREQ?` on page 537
- `BPLot:MARKer<m>:DIFFerence:GAIN?` on page 537
- `BPLot:MARKer<m>:DIFFerence:PHASe?` on page 537
- `BPLot:MARKer<m>:FREQuency` on page 538
- `BPLot:MARKer<m>:GAIN?` on page 538
- `BPLot:MARKer<m>:INDex` on page 538
- `BPLot:MARKer<m>:PHASe?` on page 538
- `BPLot:MARKer<m>:SSCReen` on page 539

Vertical position and size of the waveforms

To set the position and the vertical scaling of the gain, phase or amplitude waveforms, select the waveform and use the vertical [Scale] and [Offset/Position] (upper knob) knobs.

Remote commands:

- `BPLot:AMPLitude:SCALE` on page 537
- `BPLot:AMPLitude:POSition` on page 536
- `BPLot:GAIN:SCALE` on page 535
- `BPLot:GAIN:POSition` on page 535
- `BPLot:PHASe:SCALE?` on page 536
- `BPLot:PHASe:POSition?` on page 536

8.7.2 Using a Bode Plot

To run a Bode plot measurement

1. Prepare the measurement setup. See "[Connecting the test setup](#)" on page 190
2. Start the Bode plot option. See "[Starting the Bode plot](#)" on page 190
3. Set the required parameters. See "[Setting up the Bode plot](#)" on page 190.

Connecting the test setup

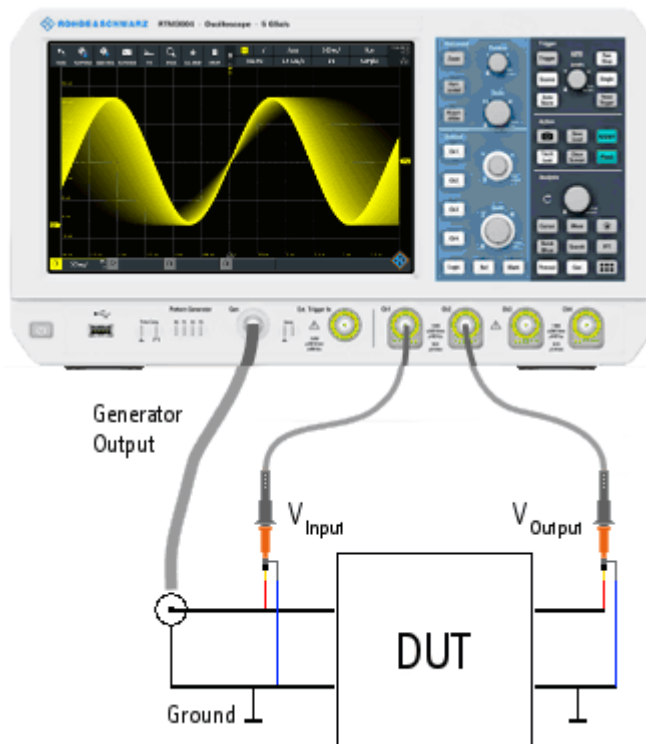

Figure 8-7: Bode Plot Test Setup

1. Connect the DUT input to the generator output of the oscilloscope.
2. Connect the input of your DUT to a channel input of the oscilloscope.
3. Connect the output of your DUT to another channel input of the oscilloscope.
4. Align the probes.



To avoid measurement uncertainties, make sure that the cables connecting the input and the output of your DUT to the oscilloscope are from similar length.

Starting the Bode plot

1. Press the  [Apps Selection] key.
2. Tap "Bode Plot" .

The Bode plot window opens.

Setting up the Bode plot

1. In the Bode window, select the channels for the "Input" and "Output" signal.
2. Set the "Start" and "Stop" frequency for the frequency sweep range.
3. Select the number of "Points" to be shown per decade.

4. Set the amplitude for the measurement.
5. If necessary, open the "Setup" dialog to refine the settings:
 - a) Set an "Amplitude Profile" for systems with sensitive circuits.
 - b) Set the "Maximum Phase" of the system.
 - c) Set a "Meas. Delay" for systems that need more time to adapt to a new frequency.
6. Press "Run" to start the measurement.
7. If necessary, press "Save" to save the measurement results to a file.

8.7.3 Bode Plot Window Controls

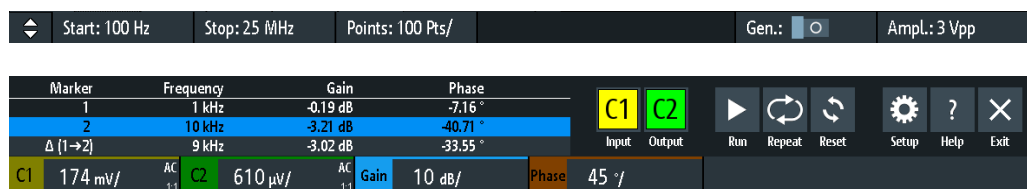

The Bode plot window provides the most important function to set up the plot and to run the test.

Start

Sets the start frequency of the sweep for the Bode plot.

Remote command:

[BPLot:FREQUENCY:START](#) on page 533

Stop

Sets the stop frequency of the sweep for the Bode plot.

Remote command:

[BPLot:FREQUENCY:STOP](#) on page 533

Points

Selects the number of points per decade that are measured from a predefined list. You can also set a different value from the predefined ones in the "Setup" menu.

Gen

Enables the in-built generator. This allows you to start a frequency sweep for a defined frequency range.

Ampl.

Sets a fixed amplitude.

Input

Selects the channel for the input signal of the DUT.

Remote command:

[BPLot:INPut\[:SOURCE\]](#) on page 533

Output

Selects the channel for the output signal of the DUT.

Remote command:

[BPLot:OUTPut\[:SOURce\]](#) on page 534

Gain

Enables the gain waveform for the Bode plot.

Remote command:

[BPLot:GAIN:ENABle](#) on page 535

Phase

Enables the phase waveform for the Bode plot.

Remote command:

[BPLot:PHASe:ENABle?](#) on page 536

Run

Starts the Bode plot measurement.

Remote command:

[BPLot:STATe](#) on page 534

Repeat

Repeats the measurement, using the same parameters.

Remote command:

[BPLot:REPeat](#) on page 534

Reset

Deletes all test results.

Remote command:

[BPLot:RESet](#) on page 534

Setup

Opens the "Setup" menu to define the Bode plot settings.

Save

Saves the created Bode plot to a file. The file format is CSV.

You can find the "Save" icon in the upper right corner of the Bode plot result table, see [Figure 8-6](#).

Remote command:

[BPLot:EXPort:NAME](#) on page 486

[BPLot:EXPort:SAVE](#) on page 487

8.7.4 Bode Plot Settings

- ▶ To open the "Bode Plot" configuration menu, tap "Setup" inside the "Bode Plot" result box.

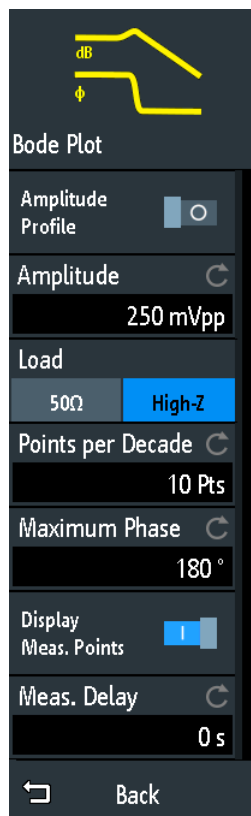

Amplitude Profile

Enables the amplitude profile. You can then define different amplitudes for different frequency in the "Configuration" dialog. This is useful when testing sensitive circuits, where the amplitude gets too high. In this case distortion might occur.

If this function is enabled, a diagram of the amplitudes for the different frequencies can be displayed on the screen. To do that, press at the bottom of the Bode plot window. You can configure the value curve through the touchscreen.



Remote command:

[BPLot:AMPLitude:MODE](#) on page 532

[BPLot:AMPLitude:ENABLE](#) on page 536

Configuration

Opens a dialog to set the amplitude profile. For each point, you can set an amplitude and frequency pairs.

Remote command:

[BPLot:AMPLitude:PROFile:POINT<n>:AMPLitude](#) on page 532

[BPLot:AMPLitude:PROFile:POINT<n>:FREQuency](#) on page 532

Ampl.

Sets a fixed amplitude.

Points

If the "Amplitude Profile" is enabled, select the number of different points that you can define for the amplitude profile.

Remote command:

[BPLot:AMPLitude:PROFile:COUNT](#) on page 532

Load

Selects the generator voltage display for 50Ω or high impedance load.

Points per Decade

Sets the number of points per decade that are measured.

Remote command:

[BPLot:POINTs:LOGarithmic](#) on page 534

Maximum Phase

Sets the upper boundary of the vertical phase window.

The lower boundary is given by "Maximum Phase" - 360°. By default, the "Maximum Phase" is set to 180° for a phase window ranging from -180° to 180° accordingly.

Display Meas. Points

Enables the display of the measurement points in the bode plot.

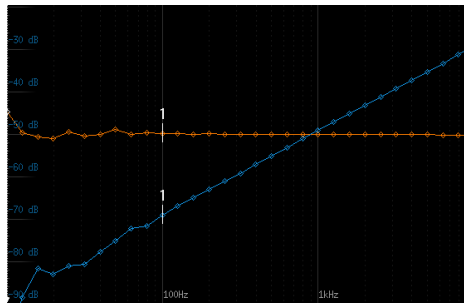

"Display Meas. Points" > On

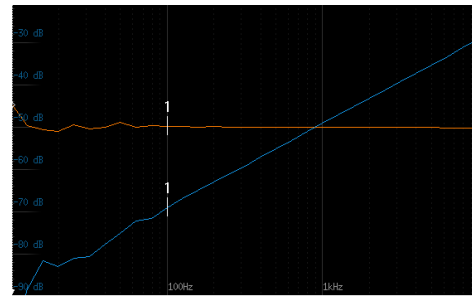

"Display Meas. Points" > Off

Remote command:

[BPLot:MEASurement:POINT\[:DISPLAY\]](#) on page 533

Meas. Delay

Sets a time delay, that the system waits before measuring the next point of the bode plot. This is helpful in systems that need more time to adapt to the new frequency, for example if filters with significant time group delays are present.

Remote command:

[BPLot:MEASurement:DELAy](#) on page 533

9 Documenting Results

The R&S RTM3000 can store various data to files for further usage, analysis and reporting:

- Instrument settings: [Chapter 9.1, "Saving and Loading Instrument Settings"](#), on page 197
- Waveforms: [Chapter 9.2, "Saving Waveform Data"](#), on page 198
- Screenshots: [Chapter 9.4, "Screenshots"](#), on page 203
- Reference waveforms
 - [Chapter 6.3, "Reference Waveforms"](#), on page 107
 - Export and import: [Chapter 9.6, "Export and Import"](#), on page 206
- Measurement statistics: [Chapter 7.2.1.1, "Statistics"](#), on page 140
- Equation sets (formularies): [Chapter 6.2.7, "Saving and Loading Formularies"](#), on page 107
- Search results: ["To save search results"](#) on page 123
- Bus table with decode results: ["To save the bus table"](#) on page 235

You can also combine these data and save it to a compressed file using the  key, see [Chapter 9.5, "Quick Save with OneTouch"](#), on page 205

- ▶ To save and load data, press the [Save Load] key.

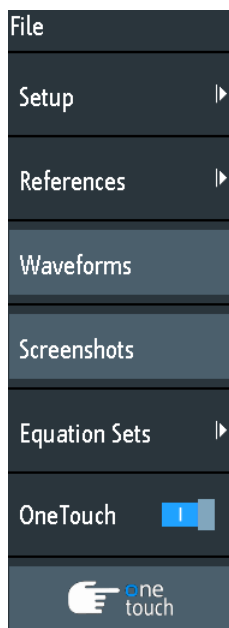

Storage locations

Waveform data, screenshots and results, which are intended for analysis outside the oscilloscope, are always saved to a USB flash drive. The USB flash drive is the exter-

nal storage location (USB_FRONT). This location is only available if the USB flash drive is connected. Using a USB hub is not supported.

Reference waveforms and instrument settings, which are intended for further use on the instrument, are usually saved to the internal storage (/INT). You can also store them to the external storage, or move them to the other location using the export and import function.

The supported file system in all storage locations is FAT.

9.1 Saving and Loading Instrument Settings

To repeat measurements or tests at different times or perform similar measurements with different test data, you can save the used configuration settings. Furthermore, it can be helpful to refer to the configuration settings of a particular measurement when analyzing the results. Therefore, you can easily save the complete measurement configuration including the display settings. The settings are saved together with a small screenshot of the display for better identification of the setup files.

By default, instrument settings are saved to the internal storage /INT/SETTINGS, but you can also save them to USB flash drive.

If you often save and load instrument settings, try the following shortcuts:

- The "Save Setup" toolbar icon saves the current settings to a file according to the settings in "File" menu > "Setup". The "Load Setup" toolbar icon opens a dialog to select and load a setup. See also "[Configuring the Toolbar](#)" on page 38.
- Configure OneTouch to save instrument settings. See [Chapter 9.5, "Quick Save with OneTouch"](#), on page 205.

To save, load, reset, export and import instrument settings

1. Press the [Save Load] key.
2. Select "Setup"
3. Select the required function.

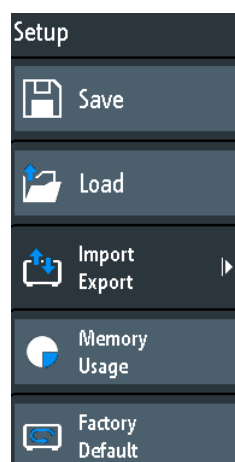

Save

Opens a dialog box to save the current instrument setup to file.

To change the storage location, select "Destination" > "Location".

Change the filename if the auto name does not fit. The file extension SET is set automatically. You can enter an optional comment that describes the setup.

Tap "Save" to start writing the data.

Remote command:

[MMEMoRY:STORe:STATe](#) on page 560

Load

Opens a file explorer to select an instrument setup file to be loaded to the instrument.

To change the storage location, select "Destination" > "Location".

Tap "Load" to change the settings.

Remote command:

[MMEMoRY:LOAD:STATe](#) on page 560

Import Export

Opens a menu to copy data between the instrument's internal storage "/INT/SETTINGS" and a USB flash drive.

Make sure that the USB flash drive is connected.

See [Chapter 9.6, "Export and Import"](#), on page 206 for a procedure description.

Memory Usage

Shows free memory space (absolute and relative) in the instrument's internal storage "/INT" and used space per subdirectory in kbyte.

If a USB flash drive is detected, the free memory space in this device is also shown.

Factory Default

Resets the instrument to the factory settings.

Remote command:

[SYSTEM:PRESet](#)

9.2 Saving Waveform Data

Waveform data is always saved to USB flash drive. The waveform export provides the following possibilities:

- Store either one waveform or all active waveforms.
- Option R&S RTM-K15: Save history data.
- Option R&S RTM-B1: Save logic channels.

To save waveforms:

1. Activate the waveforms that you want to export.

2. Press the [Save Load] key.
3. Select "Waveforms".
4. Adjust the settings in the dialog box.
5. Tap "Save".

9.2.1 Waveform Export Settings

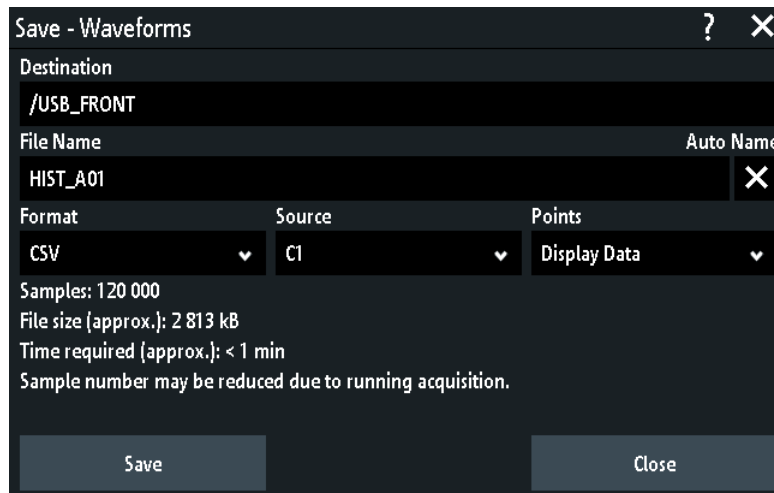

Destination

The destination `/USB_FRONT` is only active, if a USB flash drive is connected to the front USB port.

Tap and select the target folder. Tap "Accept Dir." to confirm selection. Existing files in the selected folder are listed and can be deleted here.

Remote command:

[EXPort:WAVeform:NAME](#) on page 551

File Name

Specifies the name of the file to be saved. The default is `TRACE01` or a higher number, depending on existing files in the target directory.

Remote command:

[EXPort:WAVeform:NAME](#) on page 551

Format

Selects the file format.

- "BIN - MSB": Binary data, most significant byte first
- "BIN - LSB": Binary data, least significant byte first
- "FLT - MSB": Floating point format, most significant byte first
- "FLT - LSB": Floating point format, least significant byte first
- "CSV": Comma-separated values (= default)
- "TXT": Text file format

To reload waveform data as a reference waveform, it must be stored in TRF or CSV format.

For a description of the file formats, see [Chapter 9.2.2, "Waveform File Formats"](#), on page 200.

Source

Select the channels to be saved: either one active channel, or all active channels together.

Remote command:

[EXPort:WAVeform:SOURce](#) on page 551

Points

Selects the number of data points to be saved in the waveform file.

- "Display Data": Saves all currently displayed waveform samples.
- "Acq. Memory": Saves all data samples that are stored in the acquisition memory. This setting takes effect only for stopped acquisitions. For running acquisitions, only always display data can be saved.
- "History Data": Saves the waveform data of the history segments. See also [Chapter 6.4.5, "Exporting History Data"](#), on page 118.

Remote command:

[CHANnel<m>:DATA:POINTs](#) on page 542

Save

Saves the data to the selected storage directory. The used path and filename are displayed when the storage is completed.

Saving is not possible if "Points" is set to "Acq. Memory" or "History Data" and the acquisition is running.

Remote command:

[EXPort:WAVeform:SAVE](#) on page 551

9.2.2 Waveform File Formats

Data of all waveforms is saved as a succession of values or pairs of values. Pairs of values are written as two consecutive single values. Depending on the file format, only amplitude values are stored, or the amplitude values are stored together with their time value, or frequency value in FFT mode.

With export/import, you can change the target file format and convert the data.



To reload waveform data as a reference waveform, it must be stored in TRF or CSV format.

9.2.2.1 CSV Format

In a Comma Separated Values text file, the waveform is stored in a two-columned table. Columns are separated by a comma, and the lines are separated by line breaks `\r\n` (0x0D 0x0A). Values are listed in scientific notation.

The first column contains the time values of the samples in relation to the trigger point, and the second column contains the associated amplitude values. The first line indicates the units of the values in each column, and the name of the waveform. Pairs of values are listed as two single values with the same time value (minimum and maximum).

The data can be loaded back to the instrument for further use.

Example CSV1: Waveform of channel 1, single values

```
in s,CH1 in V
-1.1996E-02,1.000E-02
-1.1992E-02,1.000E-02
-1.1988E-02,1.000E-02
-1.1984E-02,1.000E-02
```

Example CSV2: Waveform of channel 1, pairs of values

```
in s,CH1 in V
-2.9980E+00,2.000E-05
-2.9980E+00,1.400E-04
-2.9960E+00,-1.800E-04
-2.9960E+00,1.400E-04
-2.9940E+00,-1.800E-04
-2.9940E+00,1.400E-04
```

Example CSV3: FFT

```
in Hz,FFT in dBm
0.000000E+00,1.03746E+01
1.525879E+02,7.49460E+00
3.051758E+02,-1.19854E+01
4.577637E+02,-1.56854E+01
```

Import of CSV files: If you import a CSV file as reference waveform from a USB flash drive to the instrument, the import converts the data to TRF format. The instrument reads the first and the last time value and calculates the total time of the waveform, and it counts the number of values. Then all amplitude values are read one by one and written with an equidistant time distribution to the TRF file. If the first two time values are identical, the waveform is considered to consist of pairs of values.

9.2.2.2 TXT Format

TXT files are ASCII files that contain only amplitude values but no time values. Amplitude values are separated by commas. Pairs of values are listed as two subsequent single values, without any identification. Amplitude values are given in scientific notation. There is no comma at the end of the file.

Amplitude values are given in scientific notation.

Example: TXT file

```
1.000E-02,1.000E-02,1.000E-02,1.000E-02,3.000E-02
```

9.2.2.3 BIN Format

BIN files contain only binary amplitude values but no time values. Each value has a word size of 8, or 16, or 32 bit, the word size is the same throughout the file.

You can set the word order: BIN MSBF saves data in Big Endian order - beginning with the MSB (Most Significant Byte) and ending with the LSB (Least Significant Byte). BIN LSBF saves data beginning with the LSB and ending with the MSB. Pairs of values are listed as two subsequent single values, without any identification.

9.2.2.4 FLT Format

FLT files contain amplitude values in float format, where a 32-bit float value is saved in 4 successive bytes.

You can set the word order: FLT MSBF saves data in big endian order - beginning with the MSB (most significant byte) and ending with the LSB (least significant byte). FLT LSBF saves data beginning with the LSB and ending with the MSB.

9.2.2.5 TRF Format

TRF is the specific binary format for reference waveforms of the R&S RTM3000. It contains the amplitude value of each sample that is displayed on the screen (8 bit or 16 bit long). For peak-detect waveforms, 2 values per sample are saved. The file contains also time information (time of the first sample and the sample interval) and current instrument settings.

The data can be loaded as reference waveform for further use on the instrument. It is not intended for analysis outside the R&S RTM3000.

9.3 Annotations

Using the annotation tool, you can mark important places in the diagram and add text. Then you can save the annotated diagram in a screenshot.

To create annotations

1. Tap the "Annotation" icon in the toolbar.
2. Use the annotation tools to draw and write on the screen.

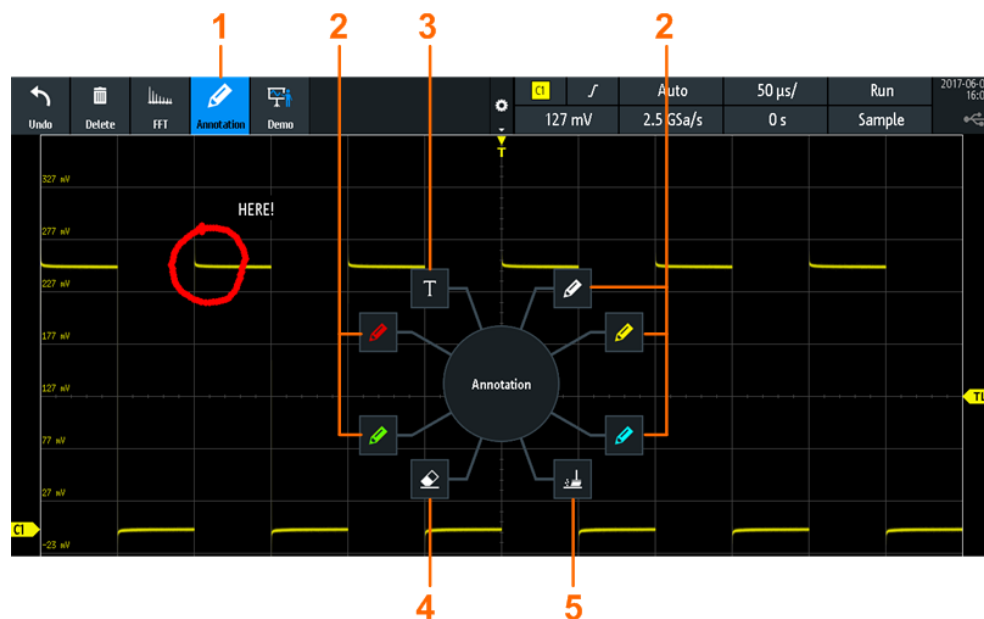

- 1 = Annotations on / off
- 2 = Drawing tools
- 3 = Text tool
- 4 = Eraser to delete single lines
- 5 = Remover to delete all annotations

3. To finish, tap the "Annotation" icon in the toolbar.
To change the tool, switch the "Annotation" tool off and on again.

9.4 Screenshots

You can create and save screenshots of the current display of your waveforms and measurement results. The R&S RTM3000 saves screenshots to USB flash drive. To save screenshots quickly, you can use the "Screenshot" toolbar icon or the [Camera] key.



You can configure the [Camera] key to save screenshots by a single keypress. See also [Chapter 9.5, "Quick Save with OneTouch"](#), on page 205.



The "Screenshot" toolbar icon saves the current display to a file according to the settings in "File" menu > "Screenshots". See also ["Configuring the Toolbar"](#) on page 38.

To save screenshots:

1. Press the [Save Load] key.
2. Disable "OneTouch"
3. Press the  key each time when you want to save a screenshot.
Alternatively, tap the "Screenshot" toolbar icon. To see the icon, add it to the toolbar.

To configure screenshots:

1. Press the [Save Load] key.
2. Select "Screenshots".
3. Adjust the target directory ("Destination"), filename, format, and color mode.

You can save the current display with "Save", or close the dialog box. The screenshot settings are saved and applied when you create screenshots with the  key.

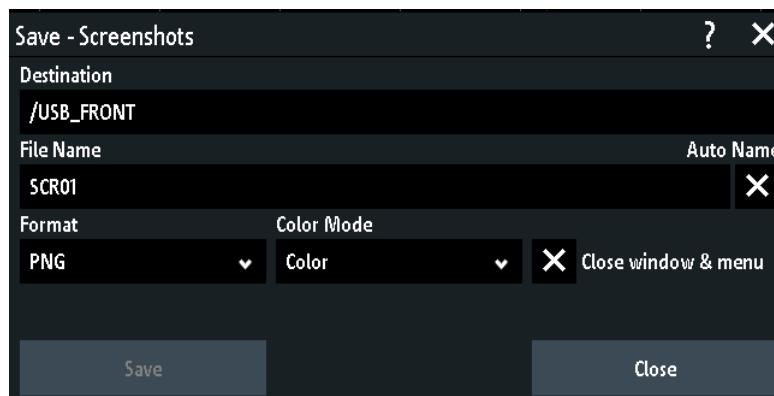

Destination

The destination `/USB_FRONT` is only active, if a USB flash drive is connected to the front USB port.

Tap and select the target folder. Tap "Accept Dir." to confirm selection. Existing files in the selected folder are listed and can be deleted here.

Remote command:

[MMEMemory:CDIRectory](#) on page 555

File Name

Specifies the name of the file to be saved. The default is `SCR01` or a higher number, depending on existing files in the target directory.

Remote command:

[MMEMemory:NAME](#) on page 552

Format

Selects the file format.

- "BMP": Bitmap is an uncompressed format, files are large and saving can take some time.
- "PNG": Portable Network Graphics is a graphic format with lossless data compression.

Remote command:

[HCOPY:FORMat](#) on page 553

Color Mode

Selects the color settings for the screenshot to be saved.

- "Grayscale": Converts the display colors to a monochrome image

- "Color": Keeps the original display colors in the screenshot.
- "Inverted": Inverts the colors of the output, so that a dark waveform is printed on a white background.
- "Inverted (gray)": Inverts the colors of the output, and converts to a monochrome image.

Remote command:

[HCOPY:COLor:SCHeme](#) on page 553

Close window & menu

If enabled, open dialog boxes and menus are closed before the screenshot is saved. Thus, the waveforms and results are always visible on the screenshot.

Remote command:

[HCOPY:CWINDow](#) on page 552

Save

Saves the screenshot to the specified file. The used path and filename are displayed when the storage is completed.

Remote command:

[HCOPY\[:IMMediate\]](#) on page 552

9.5 Quick Save with OneTouch

The  key initiates one or more assigned saving actions. By default, the key saves a screenshot.

If OneTouch is enabled, you can assign the following actions to the  key:

- Save instrument settings.
- Save a screenshot using the settings in [Save Load] > "Screenshots".
- Save waveforms using the settings in [Save Load] > "Waveforms". If "History Data" is selected under "Points", this setting is ignored, and the acquired data of the newest segment is saved.
- Save reference waveforms.
- Save search results.
- Decoded bus data ("Bus Table", requires at least one protocol option for serial bus).
- Statistical results. OneTouch is the only way to save statistical results.

All data is saved to a ZIP file on the connected USB flash drive.

To configure and use OneTouch:

1. Connect the USB flash drive.
2. Press the [Save Load] key.
3. Enable "OneTouch".
4. Tap "onetouch".

5. Select the target directory ("Destination"), filename, and data you want to save.



6. To save the data now, tap "Save".
7. Close the dialog.
8. Press the  key each time when you want to save the data.

9.6 Export and Import

To copy reference waveforms, formularies (equation sets), and instrument settings from the internal storage to USB flash drive or vice versa, the "Import Export" functions are used.

The name of the target file can be changed, so you can copy and rename in one operation. For reference waveforms, you can also change the target file format and convert the data during export/import.

1. Connect the USB flash drive.
2. Press the [Save Load] key.
3. To copy setup files, select "Setup" > "Import Export".
To copy reference waveforms, select "References".

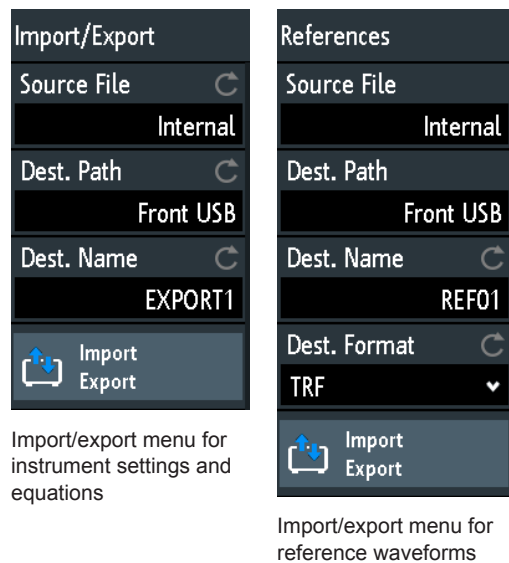

4. Define the source file for the copy operation:
 - a) Tap "Source File".
 - b) If necessary, change the storage location with "Location".
 - c) Select the folder that contains the source file.
 - d) Select the file. A small screenshot helps to identify the file.
 - e) Tap "Load".

The source file is selected, but not loaded to the R&S RTM3000.

5. Define the target directory.
 - a) Tap "Dest. Path".
 - b) If necessary, change the storage location with "Location".
 - c) Select the target folder. You can also create a folder here.
 - d) Tap "Accept Dir."
6. If necessary, change the name of the target file in "Dest. Name".

Note: If a file with the same filename already exists in the destination directory, it will be overwritten without notification.
7. For reference waveforms, you can change the file format in "Dest. Format".
8. Tap "Import Export".

The source file is copied to the destination directory with the specified name and format.

10 General Instrument Setup

The general instrument settings are available in all operating modes.

10.1 Instrument Settings



► To open the "Setup" menu:

a) Tap the "Menu" rhomb icon in the lower right corner of the screen.



b) Scroll down. Select "Setup".

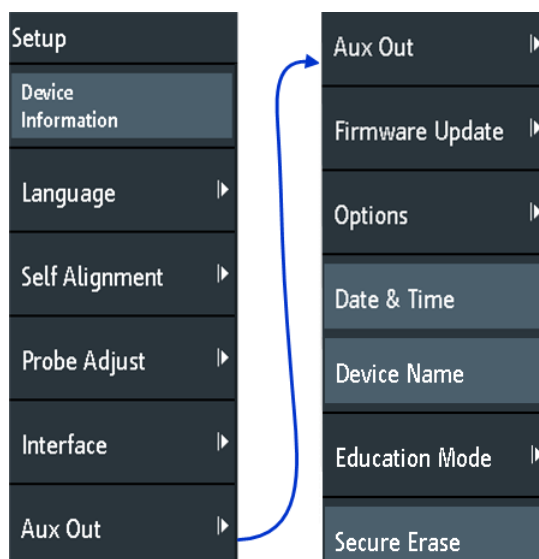

Device Information

Displays information on the instrument, such as its serial number, the installed firmware version and hardware information. This information is required if you have a support request. The dialog also contains a link to the "Open Source Acknowledgment".

Language

See [Chapter 10.6, "Setting the Data, Time and Language"](#), on page 216.

Self Alignment

See [Chapter 10.5, "Performing a Self-Alignment"](#), on page 215.

Probe Adjust

Opens the wizard for probe compensation. You can find this function also when you press the [Apps Selection] key.

See: [Chapter 4.2, "Adjusting Passive Probes"](#), on page 43.

Interface

Activates or deactivates additional instrument interfaces. Use these interfaces to communicate with the instrument, for example to read out data or automate the measuring station. USB and Ethernet (LAN) interfaces are installed in the rear panel. After selecting an interface, tap "Parameter" to define additional parameters.

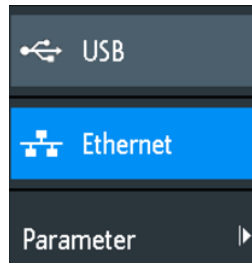

USB ← Interface

Activates the type B USB interface on the rear panel for remote control. This USB interface provides a simple way to connect the instrument to a PC. The USB 2.0 standard is supported. Use a connection cable that is suitable for a type B USB interface.

See also: [Chapter 11.2, "USB Connection"](#), on page 223.

Ethernet ← Interface

Activates the Ethernet interface on the rear panel, which allows connecting the instrument to various other devices. Access to the instrument is controlled via its IP address.

By default, the instrument is set to use DHCP. If the instrument cannot find a DHCP server, it takes about two minutes until the Ethernet parameters are available.

See also: [Chapter 11.1, "LAN Connection"](#), on page 220.

Parameter ← Interface

Opens a dialog to configure Ethernet parameters, or to select the USB connection depending on the selected interface.

Aux Out

Opens the "Aux Out" menu to define which signals are generated at the [Aux Out] connector.



"Off" Disables the auxiliary output.

"Trigger Out" Outputs a pulse when the instrument triggers.

"10 MHz" Outputs a 10 MHz reference frequency.

"Mask Violation"

Outputs a pulse when a mask is violated.

This setting is only available if the "Mask" application is selected in the "Apps Selection" dialog.

Remote command:

`TRIGger:OUT:MODE` on page 572

Firmware Update

See [Chapter 10.8, "Updating the Firmware"](#), on page 218.

Options

See [Chapter 10.7, "Options"](#), on page 217.

Date & Time

See [Chapter 10.6, "Setting the Data, Time and Language"](#), on page 216.

Device Name

Sets a name of the instrument to simplify the instrument identification. The name is shown, for example, on screenshots and in the device information.

Education Mode

Disables several functions for educational purposes or enables these functions for normal usage.

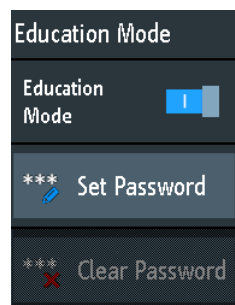

"Education Mode"

If enabled, the autoset, quick measurement and automatic measurement are disabled and not available. The active education mode is indicated in the upper right corner by a doctoral cap icon.



"Set Password"

You can enter a password to prevent unauthorized activation or deactivation of the education mode.

"Clear Password"

Deletes the password and allows all users enabling or disabling the education mode. You have to enter the password first before you can delete it.

Using the remote command, you can clear the education mode password without using the password.

Remote command:

`SYSTem:EDUCation:PRESet` on page 569

Secure Erase

Deletes current instrument configuration data and user data from the internal storage (for example, reference files, equation sets, masks). Calibration data remains in the storage.

Use this function before you send the instrument to the service. If the instrument is used in a secured environment, the function ensures that all sensitive data is removed before the instrument leaves the secured area.

Unintended "Secure Erase" is prevented by a notification that explains what happens if you proceed. To start "Secure Erase", select "Yes", otherwise select "No". Do not turn off the instrument before the erasing process has been completed.

10.2 Display Settings

- ▶ To delete all waveforms and measurement results from the display, press the [Clear Screen] key.

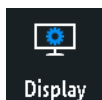

- ▶ To open the "Display" menu:
 - a) Tap the "Menu" icon in the lower right corner of the screen.
 - b) Scroll down. Select "Display".

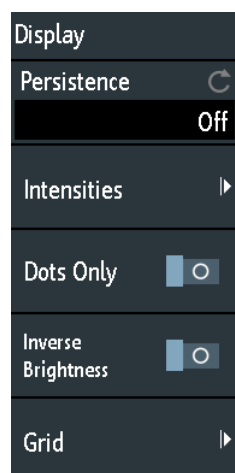

- ▶ To remove all waveforms and results from the display, press the [Clear Screen] key at the front panel.

Persistence

Defines the persistence (afterglow effect) of the waveform on the display.

"Off"	Deactivates persistence.
"Manual"	User-defined persistence according to "Time" setting.
"Infinite"	Activates persistence with infinite duration. Each new data point remains on the screen infinitely until this setting is changed or the persistence is cleared

Remote command:

[DISPlay:PERStence:TYPE](#) on page 562

Time ← Persistence

Specifies the afterglow duration if "Persistence" is set to "Manual". Each new data point remains on the screen for the time defined here. Values range from 50 ms (= default) to 12.8 s.

Remote command:

[DISPlay:PERStence:TIME](#) on page 562

Intensities

Provides functions to define the brightness (relative luminous intensity) of display elements and control LEDs.

You can also open this menu directly using the [Intensity] key.

Intensities	
Waveform	50 %
Grid	50 %
LED Brightness	75 %

Waveform ← Intensities

Defines the brightness of the waveform lines in the diagram. Enter a percentage between 0 (barely visible) and 100% or turn the [Navigation] knob to adjust the waveform brightness directly. The default value is 50%.

Remote command:

[DISPlay:INTensity:WAVEform](#) on page 564

Grid ← Intensities

Defines the brightness of the grid lines in the diagram. Enter a percentage between 0 (barely visible) and 100% or turn the [Navigation] knob to adjust the grid brightness directly. The default value is 50%.

Remote command:

[DISPlay:INTensity:GRID](#) on page 564

LED Brightness ← Intensities

Defines the intensity of illuminated front panel keys and rotary knobs in percent.

Remote command:

[DISPlay:INTensity:BACKlight](#) on page 564

Dots Only

If activated, only the individual data points are displayed. If deactivated, the individual data points are connected by a line.

Remote command:

[DISPlay:STYLE](#) on page 565

Inverse Brightness

Inverts the brightness level of the signals. Normally, values that occur frequently are brighter than rare values. This setting inverts this behavior: Rare values are brighter than frequent values. Use this setting in combination with persistence to detect rare values within the waveform.

Remote command:

[DISPlay:PALETTE](#) on page 564

Grid

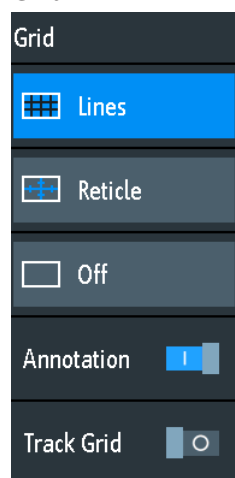

Defines how the grid is displayed.

"Lines" Displays the grid as horizontal and vertical lines.

"Reticle" Displays crosshairs instead of a grid.

"Off" Removes the grid from the display.

Remote command:

[DISPlay:GRID:STYLE](#) on page 563

Annotation ← Grid

Enables or disables the display of scale values and units for the x-axis and y-axis at the grid lines. Per default, grid labels are enabled.

Remote command:

`DISPlay:GRID:ANNotation[:ENABle]` on page 565

Track Grid ← Grid

If enabled, the grid moves with the waveforms if you change the waveform's position in horizontal or vertical direction.

If disabled (= default), the grid remains centered on the display if you change the waveform's position.

Remote command:

`DISPlay:GRID:ANNotation:TRACk` on page 565

10.3 Reset

Reset is helpful if the instrument is in undefined condition and cannot be operated.

To reset all waveform and measurement settings:

- ▶ Press [Preset].

Preset does not change the display settings, for example, intensities and brightness.

To reset these settings, restore the factory settings.

To restore the factory settings:

1. Press [Save Load].
2. Tap "Setup".
3. Tap "Factory Default".

If it is not possible to reset the instrument using the keys and the touchscreen, proceed as follows:

1. Shut down the instrument: press the [Standby] key.
2. Start the instrument: press the [Standby] key.
3. As soon as the message "Press Autoreset to restore English language" is shown on the start screen: Press and hold the Preset key until the "Update firmware" dialog is shown.
4. Tap "Exit" to close the dialog box.

All instrument settings are reset to factory defaults, and you can use the instrument as usual.

10.4 Locking the Touchscreen

The Touch Lock key locks the touchscreen to prevent unintended use. When the touchscreen is off, the key is illuminated. Press again to unlock the touchscreen.

10.5 Performing a Self-Alignment

The self-alignment aligns the data from several input channels vertically and horizontally to synchronize the timebases, amplitudes and positions.

Recommendation on performing the self-alignment:

- When putting the instrument into operation for the first time
- After a firmware update
- Once a week
- When major temperature changes occur (> 5°)

NOTICE

Preparing the instrument for self-alignment

Make sure that the instrument has been running and warming up before you start the self-alignment. The minimum warm-up time is indicated in the data sheet.

Before the self-alignment, remove all probes, leads, and other connected lines from the instrument input.

1. Remove all probes, leads, and other connected lines from the instrument inputs.
2. Open the "Setup" menu.
3. Tap "Self Alignment"
4. Tap "Start".

The alignment can take up to 15 minutes. You can stop the process with "Abort".

5. When finished, tap "OK" to close the message box.
6. Tap "Exit".

Description of settings

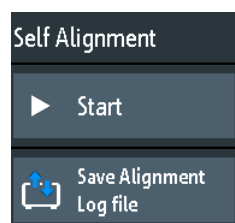

Start

Starts the internal self-calibration of the instrument. Status information is displayed on the screen.

Remote command:

[CALibration](#) on page 566

Save Alignment Log file

The log file records the results of the self-alignment. You save the log file.

Remote command:

[CALibration:STATe?](#) on page 566

10.6 Setting the Data, Time and Language

The instrument has a date and time clock. You can adjust the clock to the local time, and you can select the display language. Supported languages are listed in the data sheet. The help is provided in English. A reboot of the instrument is not necessary.

To set date and time

1. Open the "Setup" menu.
2. Scroll down the menu. Tap "Date & Time".
3. Select the date: Scroll the year, month, and day columns until the required date is displayed.
4. Select the time: Scroll the hour and minute columns until the required time is displayed.

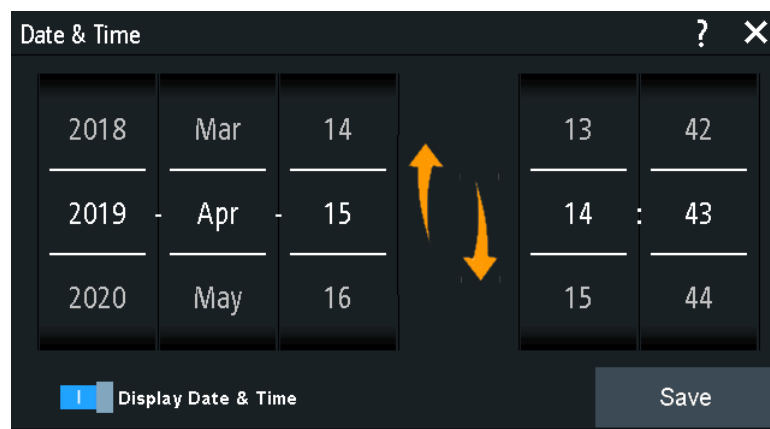

5. If you do not want to see date and time on the display, disable "Display Date & Time".
6. Tap "Save".

To set the language

1. Open the "Setup" menu.

2. Tap "Language".
3. Select the language.
The language is changed immediately.

Description of settings

Language

Selects the language in which the button labels and other screen information is displayed. The help is available only in English.

Remote command:

`DISPlay:LANGuage` on page 561

Date & Time

Provides a dialog to set the current date and time in the instrument.

Remote command:

`SYSTem:DATE` on page 566

`SYSTem:TIME` on page 567

Display Date & Time

Switches the date and time display in the upper right corner of the screen on or off.

Remote command:

`DISPlay:DTIME` on page 561

10.7 Options

All options are activated by license keys. No additional installation or hardware change is required.



Unregistered licenses

Unregistered licenses are not assigned to a particular instrument. The instrument accepts only registered licenses. If your license is delivered unregistered, use the online tool R&S License Manager to register the license for your instrument. The registration of a permanent license is irreversible, so ensure that you register it for the correct instrument. The address of the tool is <https://extranet.rohde-schwarz.com/service>.

The "Active Options" tab provides information on installed software options. Here you can install new options or deactivate existing options using license keys.

The "Inactive Options" tab lists all deactivated and expired options.

The "Deactivated Options" tab shows all deactivated options with their deactivation information and provides a function to export the deactivation response. The response is required by the R&S License Manager.

10.7.1 Activating Options

Consult your sales representative and provide the material number, serial number, and the device ID of your instrument to get a license key. You find this information in "Setup" menu > "Device Information".

The license key is provided in written form or in a file. Unregistered licenses must be registered in the R&S License Manager before they can be activated on the instrument.

1. If you received the option key in a file, save the file to a USB flash drive.
2. Connect the drive to the R&S RTM3000.
3. Tap the "Menu" icon in the lower right corner of the screen.



4. Scroll down the menu. Tap "Setup".
5. Select "Options".
6. If you received a key in written form, tap "Input option key manually". Enter the key. If you received a key in digital form as a file, tap "Read option key from file". Select path /USB_FRONT and the option key file.

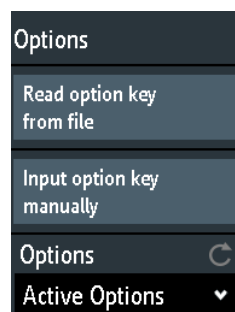

7. If you want to activate several options, repeat step 5 for each option.
8. Restart the instrument.

10.8 Updating the Firmware

Your instrument is delivered with the latest firmware version. Firmware updates are provided on the Internet at

www.rohde-schwarz.com/firmware/rtm3000.

Along with the firmware file, you find the Release Notes describing the improvements and modifications.

Make sure to update the firmware if a new version is available.

1. Download the firmware installation file *.fwu to a USB flash drive.
2. Connect the USB flash drive to the USB connector at the front of the instrument.
3. Tap the "Menu" icon in the lower right corner of the screen.



4. Scroll down the menu. Tap "Setup".
5. Select "Firmware Update"
Now you can see an info window with information about the installed and new firmware and front controller firmware. If you have no newer firmware than the installed one, a message appears.
6. Tap "Execute" to start the firmware update.
Wait until the update has finished. After installation, the instrument restarts automatically.

11 Network Connections and Remote Operation

11.1 LAN Connection

The R&S RTM3000 is equipped with a network interface and can be connected to an Ethernet LAN (local area network). A LAN connection is necessary for remote control of the instrument, and for access from a computer using a web browser.

Connecting the instrument to the LAN

1. Connect the LAN cable to the LAN connector at the rear panel of the instrument.
2. Open the "Setup" menu.
3. Tap "Interface".

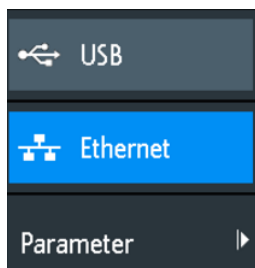

If the menu items are grayed, the connection failed. Check the connection of the LAN cable and the network availability.

4. Tap "Ethernet" to select LAN connection.
5. Tap "Parameter".

You see all connection details on the display, and you can save them to a file.

Ethernet Setup	
IP Mode	DHCP/Auto IP
IP	10.124.2.66
Subnet mask	255.255.252.0
Gateway	10.124.0.1
DNS Server	10.0.23.153
IP Port	5025
Transfer	Auto
VXI-11 Port	1024
Link	Yes
MAC	00-90-b8-1f-e4-c1
VISA	TCP/IP::10.124.2.66::INSTR
Status	DHCP, IP address received
Host name	
Password	

Figure 11-1: Example of the Ethernet setup dialog and menu

Description of settings

IP Mode

Selects the Internet protocol mode:

- "Manual": To be used if the network does not support dynamic host configuration protocol (DHCP). The addresses must be set manually.
- "DHCP/Auto IP" enables DHCP for automatic network parameter distribution and shows the values of these parameters. By default, the instrument is configured to use dynamic configuration and obtain all address information automatically. Thus, it is safe to establish a physical connection to the LAN without any previous instrument configuration.

Note that refreshing the values (for example after disconnecting the LAN cable and reconnecting it) may take a while, depending on the network responsiveness.

Remote command:

[SYSTem:COMMunicate:INTerface:ETHernet:DHCP](#) on page 570

IP, Subnet mask, Gateway, DNS Server

Show or specify:

- The instrument's IP address.
- The IP subnet mask used by the instrument.
- The IP gateway used by the instrument.
- The address of the domain name server.

Remote command:

[SYSTem:COMMunicate:INTerface:ETHernet:IPAdDress](#) on page 570

[SYSTem:COMMunicate:INTerface:ETHernet:SUBNet](#) on page 570

[SYSTem:COMMunicate:INTerface:ETHernet:GATeway](#) on page 570

IP Port, VXI-11 Port

Specify the IP port number (default = 5025) and the VXI-11 port number (default = 1024).

Remote command:

`SYSTem:COMMunicate:INTerface:ETHernet:IPPort` on page 570

`SYSTem:COMMunicate:INTerface:ETHernet:VXIPort` on page 570

Link

"Yes", if the instrument is connected to a local area network via the LAN interface on the rear panel.

"No", if no LAN connection is detected.

Transfer

Enables automatic transfer speed selection and shows the currently selected value.

Alternatively, you can select one of the predefined settings that corresponds to your network data rate.

Remote command:

`SYSTem:COMMunicate:INTerface:ETHernet:TRANsfer` on page 571

MAC, VISA

Show the instrument's media access control address, and the virtual instrument software architecture (VISA) address that is used to address the instrument in remote control.

Remote command:

`SYSTem:COMMunicate:INTerface:ETHernet:MACaddress?` on page 571

Host name

Shows or specifies the name of the instrument, which the instrument can use to connect to the DHCP server.

Status

Shows the connection status, for example "Allocating network address" or "DHCP, IP address received".

Password

Specifies an optional password for remote access to the instrument.

Reset

Deletes all IP address settings, and removes the address from the VISA string. All other settings are set to default values.

Save

Retrieves a DHCP address from the DHCP server or checks the manual IP address, updates the VISA string, checks connection and saves all settings in the instrument.

11.2 USB Connection

In addition to a LAN connection, you can use the USB connector at the rear panel to access the instrument via USB.

Connecting the instrument using USB

1. Connect the USB cable to the USB type B connector at the rear panel of the instrument, and to the computer.
2. Open the "Setup" menu.
3. Tap "Interface".

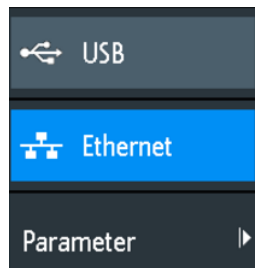

4. Tap "USB" to select USB connection.
5. Tap "Parameter".
6. Select the USB mode.
 - USB TMC (Test & Measurement Class)
 - USB VCP (Virtual Com Port)
 - USB MTP (Media Transfer Protocol)

11.2.1 USB TMC

USB TMC means USB Test & Measurement Class. You can use this interface for remote control of the instrument using SCPI commands. USB TMC does not need a driver installation but requires a VISA installation on the controlling computer. VISA is used to access the instrument, to send remote commands, and to read status information.

Rohde & Schwarz provides the standardized I/O software library R&S VISA for communication via TCP/IP (LAN: HiSlip, VXI-11) or USB (USBTMC) interfaces. R&S VISA is available for download at the Rohde & Schwarz website www.rohde-schwarz.com/rsvisa.

11.2.2 USB VCP

USB VCP uses the virtual COM port (VCP) to communicate with the measuring instrument. You can use any terminal program to send SCPI commands. USB VCP requires a USB VCP driver on the controlling computer. If the computer requests a driver installation, you can download the driver at the Rohde & Schwarz website (www.rohde-schwarz.com/de/treiber/hmo/, HO732). You need administrator rights to install the driver.

11.2.3 USB MTP

USB MTP is the USB media transfer protocol. It is a solution to load data from the oscilloscope to the computer. Remote control using SCPI commands is not possible.

USB MTP does not need a driver installation. If the instrument and the computer are connected with a USB cable and USB MTP is selected as interface, you can access the oscilloscope data from the computer. You see the oscilloscope in the computer's Device Manager and in the file explorer as portable instrument.

11.3 Remote Access Using a Web Browser

The R&S RTM3000 firmware contains a web server. If a LAN connection is established, you can access the instrument remotely using a web browser on the control computer.

The browser access allows you to:

- Check instrument data
- Save and print screenshots
- Send remote commands
- Save waveform and instrument data
- Check network settings
- Change the password
- See a live view of the display
- Control the instrument remotely

11.3.1 Accessing the Instrument Using a Web Browser

To access the R&S RTM3000, you need a LAN connection and the IP address of the instrument.

1. Obtain the IP address of the R&S RTM3000:
 - Tap the green network icon in the top right corner of the screen.

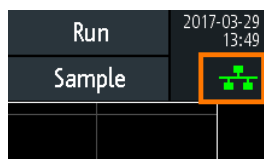

- "Setup" menu > "Interface" > "Ethernet" > "Parameter" > "IP".
2. Open an Internet browser on the control computer.
 3. Enter the IP address of the R&S RTM3000 in the address line: *http://xxx.yyy.zzz.xxx*.
The "Instrument Home" page opens.

If already another user is using the instrument via web access, connection is not possible, and you get an information about that.

11.3.2 Instrument Home

The "Instrument Home" page provides information on the instrument and the LAN connection.

Instrument Home
[Print view](#)

<ul style="list-style-type: none"> Instrument Home Screenshot SCPI Device Control Save/Load Network Settings Change Password Livescreen Remote Front Panel 	<p> Manufacturer: Rohde&Schwarz Device Class: Oscilloscope Device Type: RTB2004 Serial Number: 1333.1005k04/101136 Firmware Version: 02.000 </p>	<p> Ethernet Port Description: Rohde&Schwarz RTB2004 - 101136 Host name: R-RTB2004-01136.local. MAC-Address: 00-90-B8-1F-19-00 IP Mode: Automatic IP Address: 10.124.1.15 Subnet mask: 255.255.252.0 Default Gateway: 10.124.0.1 DNS Server: 10.0.23.153 IP Port: 5025 Transfer: 100 Mbps - Full Duplex VISA Resource String: TCPIP::10.124.1.15::INSTR Device Identification: <input type="radio"/> On <input checked="" type="radio"/> Off </p> <p> USB Device Port Vendor ID: 0AA4 (hex) Product ID: 01D7 (hex) </p>
--	--	---

11.3.3 Screenshot

The "Screenshot" page shows a copy of the instrument's display. It also provides instrument control functions and screenshot settings.

Instrument control

- "Run" and "Stop" = start and stop continuous acquisition, same as [Run Stop] key on the instrument.
- "Single" = Single key on the instrument
- "Autoset" = [Autoset] key on the instrument

- "Preset" = [Preset] key on the instrument

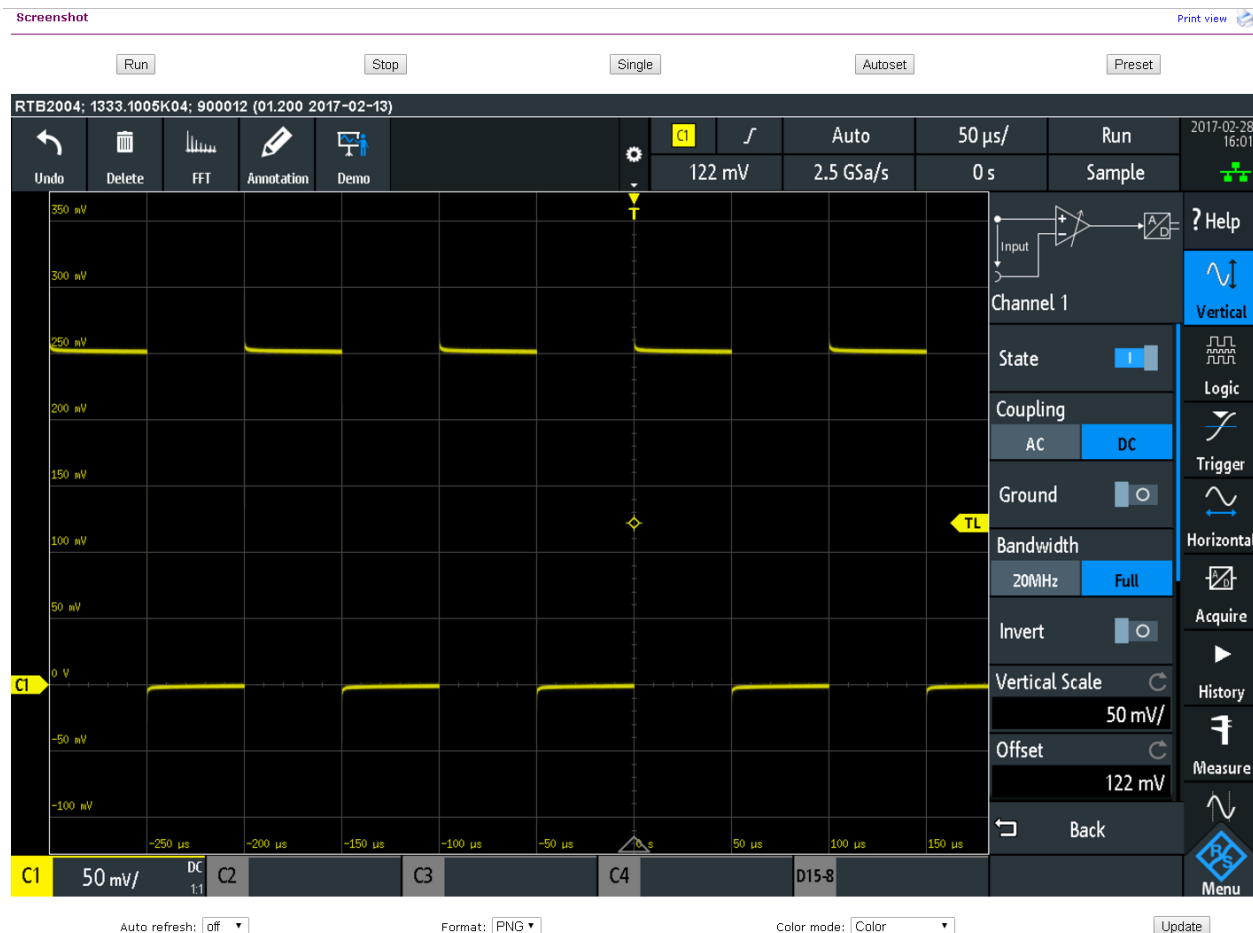

Screenshots

- "Auto refresh" and "Update"
Get the current screen content from the instrument. With "Auto refresh", you can set the interval of automatic updates.
- "Format" and "Color mode":
Set the file format and color mode of the screenshot.
- ▶ To save the screenshot, *right-click the picture* and select "Save image as".

11.3.4 SCPI Device Control

On the "SCPI Device Control" page, you can check how the transfer of remote commands is working.

You can enter a single command, for example; *IDN?, and transmit it with "Send". Do not press the [Enter] key.

If the sent command has an error, an error message is created in the background, and you do not get any response. You can see the error messages using "Last Error Message" and "All Error Messages"

SCPI Device Control

The device may be controlled with special commands (SCPI - **S**tandard **C**ommands for **P**rogrammable **I**nstruments). Please take the respectively valid instruction set from the documentation delivered with the device. If you type a wrong command or use a wrong syntax, the device creates an error message which is not send immediately, complying with the standard, but can be requested separately. In this case you will **not** get a response. An easy way to request the error messages is to use the two buttons.

Command:

Response:

Rohde&Schwarz,RTB2004,1333.1005k04/900012,01.200

11.3.5 Save/Load

On the "Save/Load" page, you can save waveform data and instrument settings to a file - either on the computer (local host) or on the instrument. On the computer, the default storage directory is the download folder, but you can change the directory using the download functions of your browser. On the instrument, the files are saved in the internal storage.

You can also load reference waveforms and instrument settings from file to the instrument ("Load from local host").

To save data to a file on the computer

1. Under "Save to local file", select the waveform or the device settings in the "Source" list.
2. Select the file "Format".

See also:

- [Chapter 9.2.2, "Waveform File Formats"](#), on page 200
- [Chapter 6.3, "Reference Waveforms"](#), on page 107

3. For analog and digital channels, select whether you want to read out the display memory ("Display Data") or the entire acquisition memory ("Acq. Memory").

- Click "Save".

Save/Load

If you want to save a waveform to a file, you first have to select the waveform, format and data. The number of samples and the file size will be indicated below. To download the waveform file, use the "Save" button.

Save to local host

Source: Format: Points:

Source: Channel 1
 Samples: 100000
 File size (approx.): 1123 kB
 Sample number may be reduced due to running acquisition.

Load from local host (max. 256 kB)

Destination: Source File:

Save to file on instrument

Source: Dest. File:

Load from file on instrument

Destination: Source File:

11.3.6 Network Settings

On the "Network Setting" page, you can change the port settings, switch off DHCP address and enter an IP address in a more comfortable way than directly on the instrument. To take effect of the changes, "Submit" them to the instrument.

"Reset" removes all modified values that were not yet sent to the instrument.

Network Settings[Print view](#) 

Warning: Changing the network settings may result in loss of connection!

Host name	<input type="text" value="R-RTB2004-01136"/>
Description	<input type="text" value="Rohde&Schwarz RTB2004 - 101136"/>
IP Mode	<input checked="" type="radio"/> Automatic <input type="radio"/> Manual
IP Address	<input type="text" value="10"/> . <input type="text" value="124"/> . <input type="text" value="1"/> . <input type="text" value="15"/>
Subnet mask	<input type="text" value="255"/> . <input type="text" value="255"/> . <input type="text" value="252"/> . <input type="text" value="0"/>
Default Gateway	<input type="text" value="10"/> . <input type="text" value="124"/> . <input type="text" value="0"/> . <input type="text" value="1"/>
DNS Server	<input type="text" value="10"/> . <input type="text" value="0"/> . <input type="text" value="23"/> . <input type="text" value="153"/>
IP Port	<input type="text" value="5025"/>
Transfer	<input type="text" value="Auto"/> ▼
	<input type="button" value="Submit"/> <input type="button" value="Reset"/>

11.3.7 Change Password

On the "Change Password" page, you can change or remove the password to protect remote access to the instrument. Alternatively, you can change the password in the Ethernet settings dialog on the instrument.

11.3.8 Livescreen

You see a live view of the instrument's display. Controlling the instrument is not possible, and only one remote connection to the livescreen is allowed at a time. Use this page for demo purposes, for example.

To close the livescreen, select "Instrument Home".

11.3.9 Remote Front Panel

On the "Remote Front Panel" page, you can remotely operate the instrument using the emulated front panel. A live view of the instrument's front panel is shown. You can use the keys, the knobs and the menus in the same way as directly on the instrument. Only one remote connection to the remote front panel is allowed at a time.

To close the "Remote Front Panel", select "Instrument Home".

12 Serial Bus Analysis

Using the R&S RTM3000 and additional options, you can analyze the following serial protocols:

- SPI no CS (Serial Peripheral Interface with 2 lines) and SPI with CS (Serial Peripheral Interface with 3 lines) - requires option R&S RTM-K1
See [Chapter 12.2, "SPI Bus \(Option R&S RTM-K1\)"](#), on page 240.
- I²C (Inter-Integrated Circuit bus) - requires option R&S RTM-K1
See [Chapter 12.3, "I²C \(Option R&S RTM-K1\)"](#), on page 248.
- UART/RS232 (EIA-232 serial interface) - requires option R&S RTM-K2
See [Chapter 12.4, "UART / RS232 \(Option R&S RTM-K2\)"](#), on page 258.
- CAN (Controller Area Network) - requires option R&S RTM-K3
See [Chapter 12.5, "CAN \(Option R&S RTM-K3\)"](#), on page 264.
- LIN (Local Interconnect Network) - requires option R&S RTM-K3
See [Chapter 12.6, "LIN \(Option R&S RTM-K3\)"](#), on page 278.
- Audio Signals - requires option R&S RTM
See [Chapter 12.7, "Audio Signals \(Option R&S RTM-K5\)"](#), on page 291.
- MIL-1553 - requires option R&S RTM
See [Chapter 12.8, "MIL-STD-1553 \(Option R&S RTM-K6\)"](#), on page 300.
- ARINC 429 - requires option R&S RTM
See [Chapter 12.9, "ARINC 429 \(Option R&S RTM-K7\)"](#), on page 311.

To analyze parallel buses, you need MSO option R&S RTM-B1 to get the logic channels. See [Chapter 14, "Logic Analyzer \(Option R&S RTM-B1, MSO\)"](#), on page 372.

12.1 Basics of Protocol Analysis

The analysis of serial data consists of the following main steps:

- Protocol configuration:
Select the protocol type, configure the input lines and the protocol-specific settings.
- Decoding:
Select the display format of the decoded data. The digitized signal is displayed on the screen together with the decoded content of the messages in combs. You can scale the signal display and zoom into it to see it in more detail.
You can also list the decoded results in tabular form in the bus table.
- Triggering:
You can trigger on various events that are typical for the configured bus type. For example, trigger on start or stop of messages, or on serial patterns.
- Search:
On CAN and LIN buses, you can search for events. The search events are similar to the trigger events. The search finds all matching events in an acquisition, while the trigger finds only the trigger event.

Analysis can be performed on analog and digital input channels. Digital channels require if MSO option R&S RTM-B1.

You can configure 4 protocol buses and select one of the configured buses for analysis.

- [Protocol - Common Settings](#)..... 231
- [Displaying Decode Results](#)..... 233
- [Bus Table: Decode Results](#)..... 234
- [Bus Labels](#)..... 236
- [Label List](#)..... 237

12.1.1 Protocol - Common Settings

- ▶ To open the protocol setup, press the [Protocol] key.

The common settings in the "Protocol" menu define the bus type and open further menus to adjust the display of the decoded bus signal.

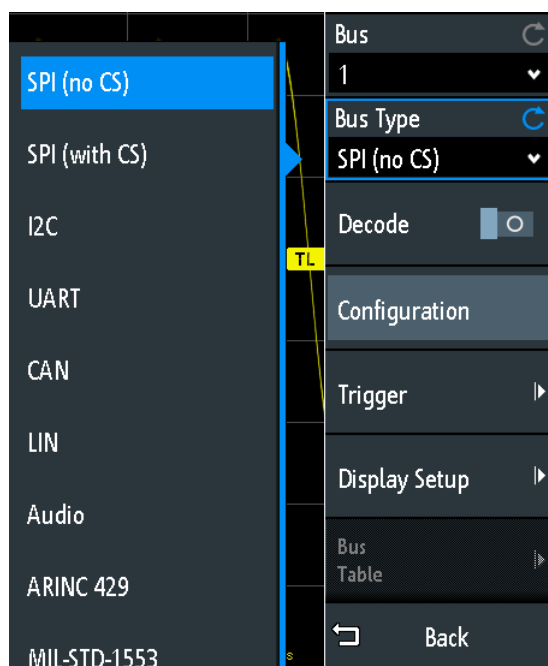

Figure 12-1: Protocol menu with bus types expanded

Bus

Selects the bus to be configured and analyzed.

Bus Type

Defines the bus or interface type for analysis. Available buses depend on the installed options.

Remote command:

[BUS:TYPE](#) on page 574

Decode

Enables protocol decoding for the selected bus.

Remote command:

[BUS:STATe](#) on page 574

Configuration

Opens or closes the dialog box with configuration settings of the selected bus.

The following chapters describe manual protocol configuration:

- [Chapter 14.5, "Parallel Buses"](#), on page 377
- [Chapter 12.2.2, "SPI Configuration"](#), on page 241
- [Chapter 12.3.2, "I²C Configuration"](#), on page 250
- [Chapter 12.4.2, "UART Configuration"](#), on page 258
- [Chapter 12.5.2, "CAN Configuration"](#), on page 266
- [Chapter 12.6.2, "LIN Configuration"](#), on page 280
- [Chapter 12.7.2, "Audio Configuration"](#), on page 293
- [Chapter 12.8.2, "MIL-STD-1553 Configuration"](#), on page 303
- [Chapter 12.9.2, "ARINC 429 Configuration"](#), on page 312

Trigger

Opens the trigger setup for the selected protocol.

The following chapters describe protocol triggering:

- [Chapter 12.2.3, "SPI Trigger"](#), on page 244
- [Chapter 12.3.3, "I²C Trigger"](#), on page 252
- [Chapter 12.4.3, "UART Trigger"](#), on page 261
- [Chapter 12.5.3, "CAN Trigger"](#), on page 268
- [Chapter 12.6.3, "LIN Trigger"](#), on page 282
- [Chapter 12.7.2, "Audio Configuration"](#), on page 293
- [Chapter 12.8.3, "MIL-STD-1553 Trigger"](#), on page 305
- [Chapter 12.9.3, "ARINC 429 Trigger"](#), on page 314

Triggering on parallel buses is not possible.

Note: Selecting "Trigger" in the protocol menu automatically enables protocol decoding.

Display Setup

Opens a menu to define display settings, e.g. data formats. Display settings are valid for all protocol types.

See [Chapter 12.1.2, "Displaying Decode Results"](#), on page 233.

Label List

Opens a menu to load and apply a list with symbolic names of addresses or identifiers. Only available for CAN and LIN.

See [Chapter 12.1.5, "Label List"](#), on page 237.

Bus Table

Opens a menu to define bus table settings for the decoded frames of the acquisition.

See [Chapter 12.1.3, "Bus Table: Decode Results"](#), on page 234.

Label

Opens a menu to define a label for the selected bus.

See [Chapter 12.1.4, "Bus Labels"](#), on page 236.

12.1.2 Displaying Decode Results

When the configuration of a serial bus is complete, the instrument can decode the signal. The decode results are displayed in two ways:

- Bus signal with combs, time-correlated to the input signals. The combs show the values of the frames or words.
- Bus table. The table lists data values and time information of the frames or words. For details, see [Chapter 12.1.3, "Bus Table: Decode Results"](#), on page 234.

To decode a serial bus

- ▶ In the "Bus" menu, enable "Decode".

The bus signal with combs is shown. The colors of the combs are protocol-specific and described in the "Decode Results" chapters of the protocol description.

To adjust scaling and position of the decoded bus signal

1. The horizontal size of the combs is defined by the horizontal time scale, which is the same for input signals and the bus signal. Turn the horizontal [Scale] knob to change the time scale.
2. To adjust the trigger position, turn the horizontal [Position] knob.
3. The vertical size and position are specific for the selected bus signal.
 - a) Tap the bus signal to set the focus to it.
 - b) Turn the vertical [Scale] knob to set the height of the combs.
 - c) Turn the upper knob in the Vertical section to move the bus signal vertically on the screen.
 - d) To set the signal to the center of the display, press the upper knob in the Vertical section.

Remote commands

- [BUS:DSIZE](#) on page 575
- [BUS:POSition](#) on page 576

To set the data format and bit display

1. Press the [Protocol] key.
2. Select "Display Setup".

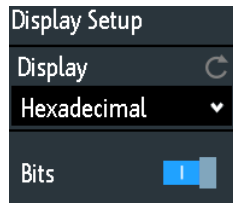

Display

Selects the decoding format of the data: binary, hexadecimal, decimal, octal or ASCII. The setting applies to the data in the combs of the decoded bus line, and to the bus table.

Remote command:

[BUS:FORMat](#) on page 575

Bits

Enables the display of the individual bit lines above the decoded bus line.

Remote command:

[BUS:DSIGnals](#) on page 575

12.1.3 Bus Table: Decode Results

The bus table shows the detailed decoded data for each frame of the acquisition. At running acquisition, the table results are updated continuously. In stop mode, you can access the individual frames and analyze them. If the data of a frame is long, several lines per frame are shown. Scrolling and selecting is frame-based, i.e. scroll from frame to frame, and you select always a frame, not a single line of the frame.

You can also save the results to CSV file.

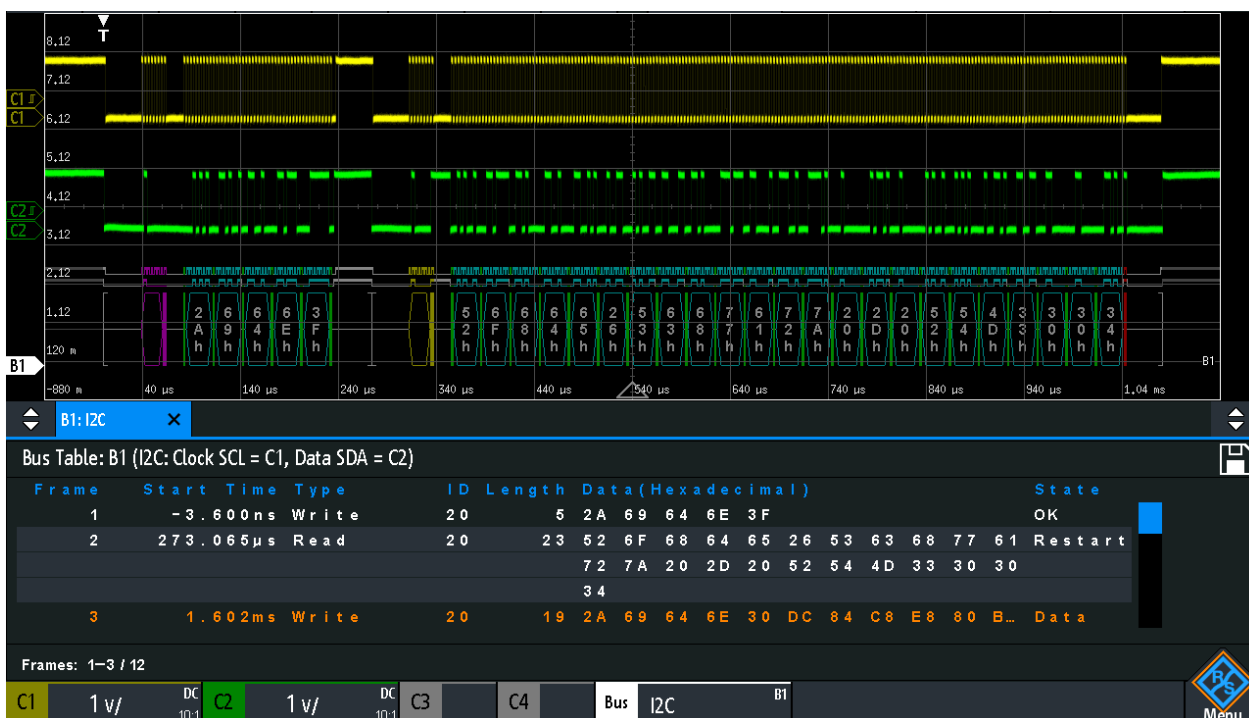

Figure 12-2: Example of a bus table: decode results of an I2C bus

To open the bus table

1. In the "Bus" menu, select "Bus Table".
2. Select "Bus Table".

The menu entry gets highlighted, and the bus table is shown below the diagram.

To navigate in the bus table

1. To adjust the table size, drag up or down one of the arrow buttons on the left or right.
2. Stop the acquisition.
3. In the "Bus Table" menu, select "Track Frame".
4. Tap a frame in the bus table.

The start of the selected frame is marked by a line and a rhomb. This marker is moved to the center of the diagram, followed by the decoded data.

To save the bus table

1. If you want to save the data outside the instrument, connect a USB flash drive.
2. Tap the "Save" symbol in the upper right corner of the bus table.
3. Select the correct "Destination" and the path.

You can also store the data on the instrument. Therefore, select the "Destination" "/INT/BUSTABLE".

4. If necessary, change the filename and enter a comment.
5. Tap "Save".

The data is saved to a CSV file.

Bus table menu

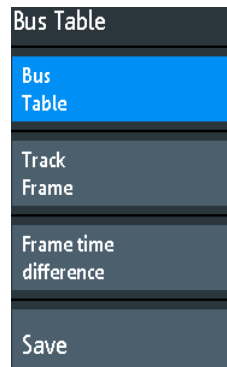

Bus Table

Displays or hides a table of decoded signal data.

Remote command:

[BUS:RESuLt](#) on page 576

Track Frame

If enabled, the selected frame in the bus table is automatically synchronized with the waveform display.

The function is only available if the acquisition has been stopped.

Frame time difference

If selected, the time column in the bus table shows the frame's time difference to the previous frame. The column is indicated with "Time diff.". If the setting is disabled, the absolute time in relation to the trigger point is shown in the "Start Time" column.

Save

Opens the "Save" menu to save the decoded data in a CSV file (comma-separated list).

12.1.4 Bus Labels

A bus label is a name of a bus. The bus label is shown on the right side of the display at the bus signal, and in the bus table.

Do not confuse "Label" and "Label List". The "Label" names the bus, while the "Label List" contains the names of bus nodes identified by addresses or identifiers.

Access: [Protocol] > "Label"



Label

Displays or hides the bus label. The bus label is shown on the right side of the display at the bus signal, and in the bus table. The bus and its label are only visible, if "Decode" is enabled.

You can enter a label text in several ways:

- Select a string from the library list with "Predefined Label".
- Enter a user-defined text using "Edit Label".

Remote command:

[BUS:LABel:STATe](#) on page 575

Predefined Label

Selects a predefined label text. You can edit the text with "Edit Label".

Edit Label

Opens on-screen keypad to enter a label text. If you previously have selected a predefined label, it is already written in the entry line, and you can modify it.

The maximum name length is 8 characters, and only ASCII characters provided on the on-screen keypad can be used.

Remote command:

[BUS:LABel](#) on page 575

12.1.5 Label List

For all protocols using ID or address identification, it is possible to create label lists containing addresses or IDs, a symbolic name for each node (symbolic label), and some protocol-specific information.

You can also use the label list to trigger on an identifier or address. Instead of entering the value, you select the name, which is defined in the label list.

The format of label list files is PTT.

Label lists are protocol-specific. They are described in the corresponding protocol chapters:

- [Chapter 12.5.6, "CAN Label List"](#), on page 276
- [Chapter 12.6.6, "LIN Label List"](#), on page 289

12.1.5.1 Using Label Lists

To load a label list and display the labels

1. Save the label list file on a USB flash drive.
2. Press the [Protocol] key.
3. Configure the protocol.
4. In the "Bus" menu, select "Label List".

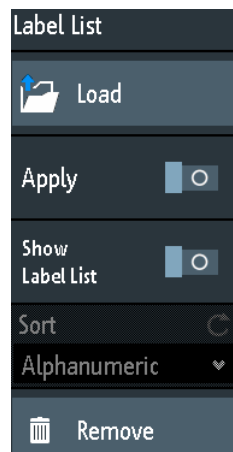

5. Select "Load".
6. Navigate to the label list file, select it, and tap "Load".
7. To read the label list, tap "Show Label List".
8. To see the node labels in the display of the decoded data, tap "Apply".

To trigger on an identifier or address using the label

Prerequisites: The bus is configured, decoding is enabled, and a decoded signal is visible.

1. Open the "Bus" menu.
2. Select "Trigger".
3. Set the following trigger settings:
 - a) "<Protocol> Trigger" = "Identifier", or "Identifier + Data", or "Address", or "Address and Data".
 - b) Tap "Symbolic ID".
 - c) Select the label. The list provides all symbolic names that are defined in the loaded file.
4. Close the dialog.
5. Set the trigger mode to "Normal".

12.1.5.2 Content and Format of the PTT File

Label lists are stored as PTT (protocol translation table) files. The PTT file format is an extension of the CSV format (comma-separated values). You can edit it with standard editors, for example, with MS Excel or a text editor.

The PTT file has three types of lines:

- Comment lines begin with a hash character #. A hash character at any other position in the line is treated like a standard character.
- Command lines begin with a commercial at character @. An @ character at any other position in the line is treated like a standard character.
- Standard lines are the lines that not qualify as comment or command lines. They build the core of the label list.

Command lines

Command lines define the version of the PTT file and the protocol name:

- @FILE_VERSION: must appear exactly once in the file
- @PROTOCOL_NAME: must appear at least once in the file. Thus, one file can contain several label lists for different protocols.

```
# --- Start of PTT file
@FILE_VERSION = 1.0
@PROTOCOL_NAME = i2c
[... Label list for I2C]
@PROTOCOL_NAME = can
[... Label list for CAN]
# --- End of PTT file
```

Standard lines

Standard lines define the contents of the label list. The rules for standard lines follow the csv convention, they are:

- Values are separated by commas
- Space characters following a delimiter are ignored
- Values with a special character (comma, newline, or double quote) must be enclosed in double quotes
- Text in double quotes must be escaped by double quote characters

The format of the numeric value is indicated by a suffix. The following formats are supported:

Format	Suffix	Example
Decimal	<empty> d	106, DeviceName 106d, DeviceName
Hexadecimal	h	6Ah, DeviceName or prefix: 0x6A, DeviceName

Format	Suffix	Example
Octal	o	152o, DeviceName
Binary	b	01101010b, DeviceName

The maximum supported word size for (unsigned) integers is 64 bits.

```
# --- Start of PTT file
@FILE_VERSION = 1.0
@PROTOCOL_NAME = i2c
#   Following two lines are equal:
7,01h, Temperature
7,01h, Temperature
#   A comma must be enclosed in double quotes:
7,01h, "Temperature, Pressure, and Volume"
#   A double quote must also be enclosed in double quotes:
7,7Fh, "Highspeed ""Master"" 01"
#   Following lines yield the same result:
7d,0x11, Pressure
7h,11h, Pressure
0x7,17d, Pressure
7,17, Pressure
```

12.2 SPI Bus (Option R&S RTM-K1)

- [The SPI Protocol](#).....240
- [SPI Configuration](#).....241
- [SPI Trigger](#).....244
- [SPI Decode Results](#)247

12.2.1 The SPI Protocol

A 4-channel instrument is required for full support of the SPI protocol, or the MSO option R&S RTM-B1.

The Serial Peripheral Interface SPI is used for communication with slow peripheral devices, in particular, for transmission of data streams.

Main characteristics of SPI are:

- Master-slave communication
- No device addressing; The slave is accessed by a chip select, or slave select line.
- No acknowledgement mechanism to confirm receipt of data
- Duplex capability

Most SPI buses have four lines, two data and two control lines:

- Clock line to all slaves (SCLK)

- Slave Select or Chip Select line (SS or CS)
- Master data output, slave data input (MOSI or SDI)
- Master data input, slave data output (MISO or SDO)

When the master generates a clock and selects a slave device, data may be transferred in either or both directions simultaneously.

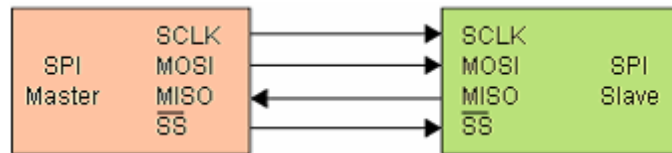

Figure 12-3: Simple configuration of SPI bus

The data bits of a message are grouped by following criteria:

- A word contains a number of successive bits. The word length is defined in the protocol configuration.
- A frame contains a number of successive words, at least one word.

For SPI buses, the R&S RTM3000 provides the following trigger possibilities:

- On frame start
- On frame end
- On a specified bit in the message
- On a serial pattern at a specified position

12.2.2 SPI Configuration

The correct setup of the protocol parameters and the threshold is the condition for decoding the signal.

To set up and decode an SPI signal (with or without CS)

1. Press the [Protocol] key in the Analysis area of the front panel.
2. Select the bus that you want to use: B1, B2, B3 or B4.
3. Select the "Bus Type" = "SPI (no CS)" or "SPI (with CS)".
4. Select "Configuration".
5. Select the sources of the signal lines, the channels to which the lines are connected.
6. Set the threshold. Use one of the following methods:
 - Tap "Find Threshold". The instrument evaluates the signal and sets the threshold.
 - Enter the threshold value in the numeric field.
7. Set the other signal parameters according to the signal characteristics. All settings are described below.

8. In the "Bus" menu, enable "Decode".

SPI configuration settings

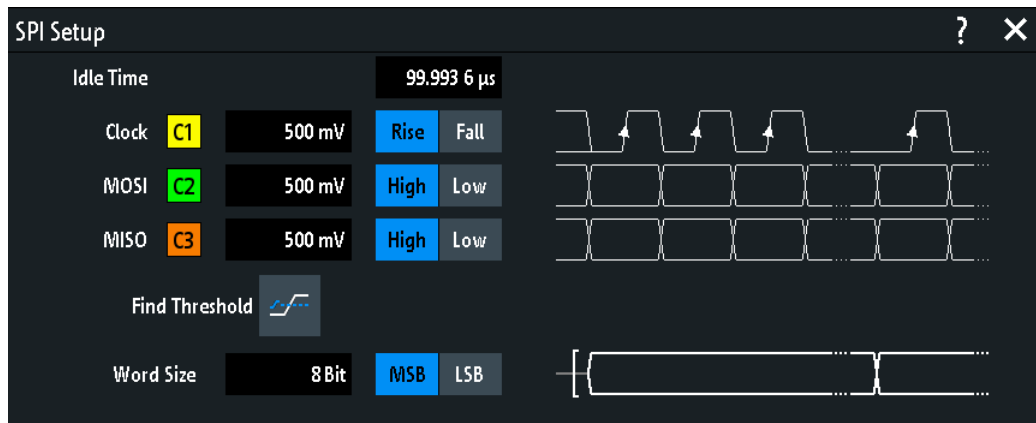

Figure 12-4: SPI (no CS) setup

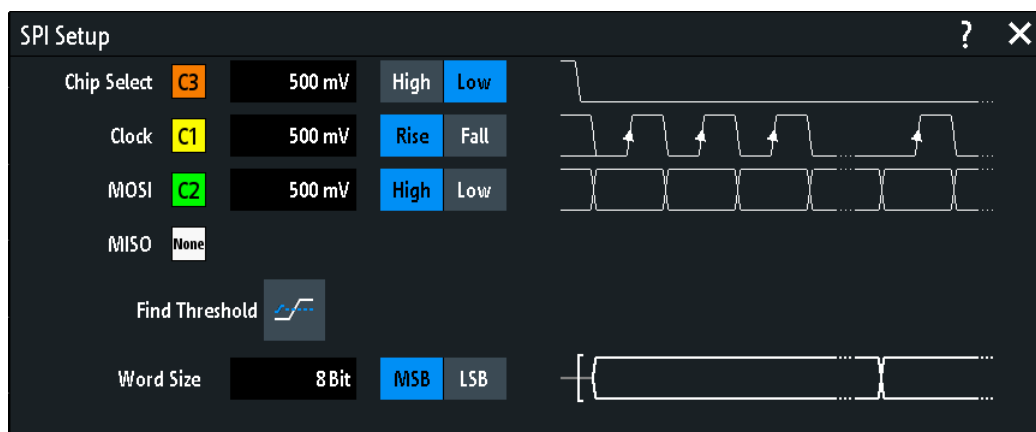

Figure 12-5: SPI (with CS) setup

Chip Select.....	242
Clock.....	243
Slope.....	243
MOSI / MISO / Data.....	243
Polarity.....	243
Threshold, Find Threshold.....	243
Word Size.....	244
Idle Time.....	244

Chip Select

Selects the input channel of the chip select (CS) line. Only available in the "SPI (with CS)" setup.

If the MSO option R&S RTM-B1 is installed, you can use logic channels as source.

Remote command:

`BUS : SPI : CS : SOURce` on page 577

Clock

Selects the input channel of the clock line.

If the MSO option R&S RTM-B1 is installed, you can use logic channels as source.

Remote command:

[BUS:SPI:CLOCK:SOURce](#) on page 577

[BUS:SSPI:CLOCK:SOURce](#) on page 580

Slope

Selects if data is sampled on the rising or falling slope of the clock. The clock slope marks the begin of a new bit.

Remote command:

[BUS:SPI:CLOCK:POLarity](#) on page 578

[BUS:SSPI:CLOCK:POLarity](#) on page 580

MOSI / MISO / Data

Select the input channel of the data lines. MOSI is mandatory, the MISO line is optional.

If the MSO option R&S RTM-B1 is installed, you can use logic channels as source.

Note: MISO is available only on bus 1 and bus 3. On bus 2 and bus 4, you can set only one "Data" line. The MISO line occupies a second bus line. Thus, if MISO is used on bus 1 or bus 3, bus 2 or bus 4 is not available respectively.

Remote command:

[BUS:SPI:MOSI:SOURce = BUS:SPI:DATA:SOURce](#) on page 578

[BUS:SPI:MISO:SOURce](#) on page 578

[BUS:SSPI:MOSI:SOURce = BUS:SSPI:DATA:SOURce](#) on page 581

[BUS:SSPI:MISO:SOURce](#) on page 581

Polarity

Selects if the transmitted signal is high active (high = 1) or low active (low = 1).

For CS, the default is low active.

For MOSI / MISO, the default is high active.

For data, the default is high active.

Remote command:

[BUS:SPI:MOSI:POLarity = BUS:SPI:DATA:POLarity](#) on page 578

[BUS:SPI:MISO:POLarity](#) on page 579

[BUS:SSPI:MOSI:POLarity = BUS:SSPI:DATA:POLarity](#) on page 581

[BUS:SSPI:MISO:POLarity](#) on page 582

Threshold, Find Threshold

Set the signal threshold for the source channel. Enter a value, or use "Find Threshold" to set the threshold to the middle reference level of the measured amplitude.

For analog channels, you can find the value also in the "Vertical" menu > "Channel <n>" > "Threshold"

For logic channels, you can find the value also in the "Logic" menu > "Technology".

Remote command:

[CHANnel<m>:THReshold](#) on page 421

[CHANnel<m>:THReshold:FINDlevel](#) on page 422

[DIGital<m>:THReshold](#) on page 739

Word Size

Sets the word length (or symbol size), which is the number of bits in a message. The maximum word length is 32 bit.

You can also define the bit order, which determines if the data of the messages starts with "MSB" (most significant bit) or "LSB" (least significant bit).

Remote command:

[BUS:SPI:SSIZe](#) on page 579

[BUS:SSPI:SSIZe](#) on page 582

[BUS:SPI:BORDer](#) on page 579

[BUS:SSPI:BORDer](#) on page 582

Idle Time

Sets the burst idle time, during which the data and clock lines are low. Only available in the "SPI (no CS)" setup.

A new frame begins when the idle time has expired and the clock line has been inactive during that time. If the time interval between the data words is shorter than the idle time, the words are part of the same frame.

Remote command:

[BUS:SSPI:BITime](#) on page 582

12.2.3 SPI Trigger

Before you set up the trigger, make sure that the bus is configured correctly. See [Chapter 12.2.2, "SPI Configuration"](#), on page 241.

To trigger on SPI signals:

1. Press the [Protocol] key in the Analysis area of the front panel.
2. Select the bus that is configured for SPI.
3. Select "Trigger".

This selection has several effects:

- Enables decoding, if necessary.
- Sets the "Trigger Type" to "Serial Bus" and the trigger source to the selected bus.
- Displays the "SPI Trigger" condition in the dialog box, below the protocol setup.

4. Check the "Source" and change it if necessary.
5. At "SPI Trigger", select the required trigger type:
 - "Frame Start": beginning of the message
 - "Frame End": end of the message

- "Bit <x>": a specified bit inside the message
 - "Serial Pattern": a bit pattern in the message
6. If "Serial Pattern" is selected, the SPI trigger setup dialog expands to define the serial pattern.

SPI trigger settings

The trigger settings are shown in the dialog below the bus configuration settings. In the trigger menu, you select the trigger source, and open or close the setup dialog box.

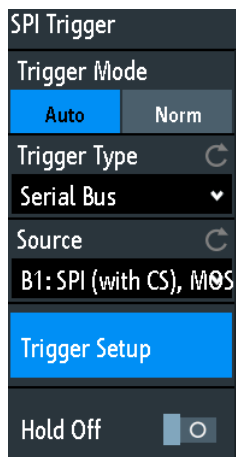

Figure 12-6: SPI trigger menu

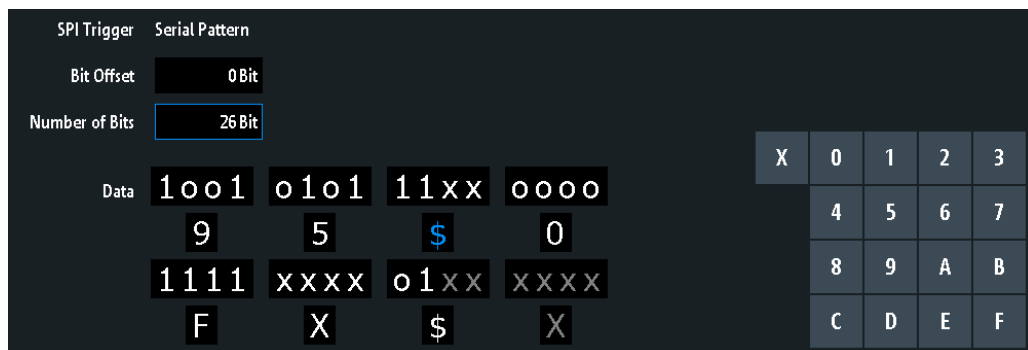

Figure 12-7: SPI trigger settings with an example of an SPI serial pattern

- 9 = Hex value of the 1st nibble, with the binary value 1001
- \$ (blue) = Hex value of the 3rd nibble, which includes some "X" bits. The blue color indicates that the keypad is active for this nibble.
- X (white) = The 6th nibble is a "don't care" nibble, as it consists of "X" bits, only
- \$ (white) = The 7th nibble is only half contained in the specified pattern length of 26 bits
- X (gray) = The 8th nibble is not contained in the specified pattern

Source.....246

SPI Trigger.....246

Bit Offset.....246

Number of Bits.....246

Data.....247

Source

If both MOSI and MISO lines are configured for analysis, select which line is the trigger source.

Remote command:

[TRIGger:A:SOURce:SPI](#) on page 583

SPI Trigger

Selects the trigger condition.

- "Frame Start" Sets the trigger to the start of the message:
- For SPI with CS, the frame starts when the chip select signal CS changes to the active state.
 - For SPI without CS, the frame starts when the idle time has expired.
- "Frame End" Sets the trigger to the end of the message.
- For SPI with CS, the frame ends when the chip select signal CS changes to the inactive state.
 - For SPI without CS, the frame ends when the idle time has expired after the last clock and no new clock appeared during that time.
- "Bit <x>" Sets the trigger to the bit number specified with ["Bit Offset"](#) on page 246.
- "Serial Pattern" Expands the trigger setup dialog to configure the bit pattern to be triggered at. Set ["Number of Bits"](#) on page 246 and ["Data"](#) on page 247 to define the pattern, and ["Bit Offset"](#) on page 246 to define the pattern position.

Remote command:

[TRIGger:A:SPI:MODE](#) on page 583

Bit Offset

Specifies the number of bits before the first bit of the pattern. These bits are ignored. The first bit after frame start is Bit 1. For example, with bit offset = 2, Bit 1 and Bit 2 are ignored, and the pattern starts with Bit 3.

If "SPI Trigger" is set to "Bit <x>", the trigger is set to the next bit that follows the offset bits. For example, if the bit offset is 4, the instrument triggers on the start of the 5th bit.

Remote command:

[TRIGger:A:SPI:POFFset](#) on page 584

Number of Bits

Defines the length of the serial pattern in bits.

Note: Entering data bits beyond the specified length of the pattern automatically adjusts the "Number of Bits" to include all entered bits.

Remote command:

[TRIGger:A:SPI:PLENght](#) on page 584

Data

Specifies the data pattern if "SPI Trigger" is set to "Serial Pattern". When the instrument detects the specified data pattern, it sets the trigger to the first bit of this pattern.

An example of pattern definition is shown in [Figure 12-7](#).

To enter the binary value of any bit, tap this bit. To enter the hexadecimal value, tap one of the nibbles (half byte) in the lower data line.

If a nibble (half byte) contains 1, 2 or 3 "X" bits (don't care), the nibble value is represented by the character "\$". If all 4 bits of a nibble are "X", the nibble itself is "don't care", represented by the character "X".

Remote command:

[TRIGger:A:SPI:PATtern](#) on page 584

12.2.4 SPI Decode Results

When the configuration of the serial bus is complete, the signal can be decoded:

1. In the "Bus" menu, enable "Decode".
2. In the "Display" menu, select the result display settings.
See [Chapter 12.1.2, "Displaying Decode Results"](#), on page 233.
3. In the "Bus Table" menu, enable the "Bus Table". Adjust the table settings.
See also: [Chapter 12.1.3, "Bus Table: Decode Results"](#), on page 234

The instrument captures and decodes the signal according to the protocol definition and the configuration settings.

The color-coding of the various protocol sections and errors simplifies the interpretation of the visual display. The decode information condenses or expands, depending on the horizontal scale. Various data formats are available to show the result values.

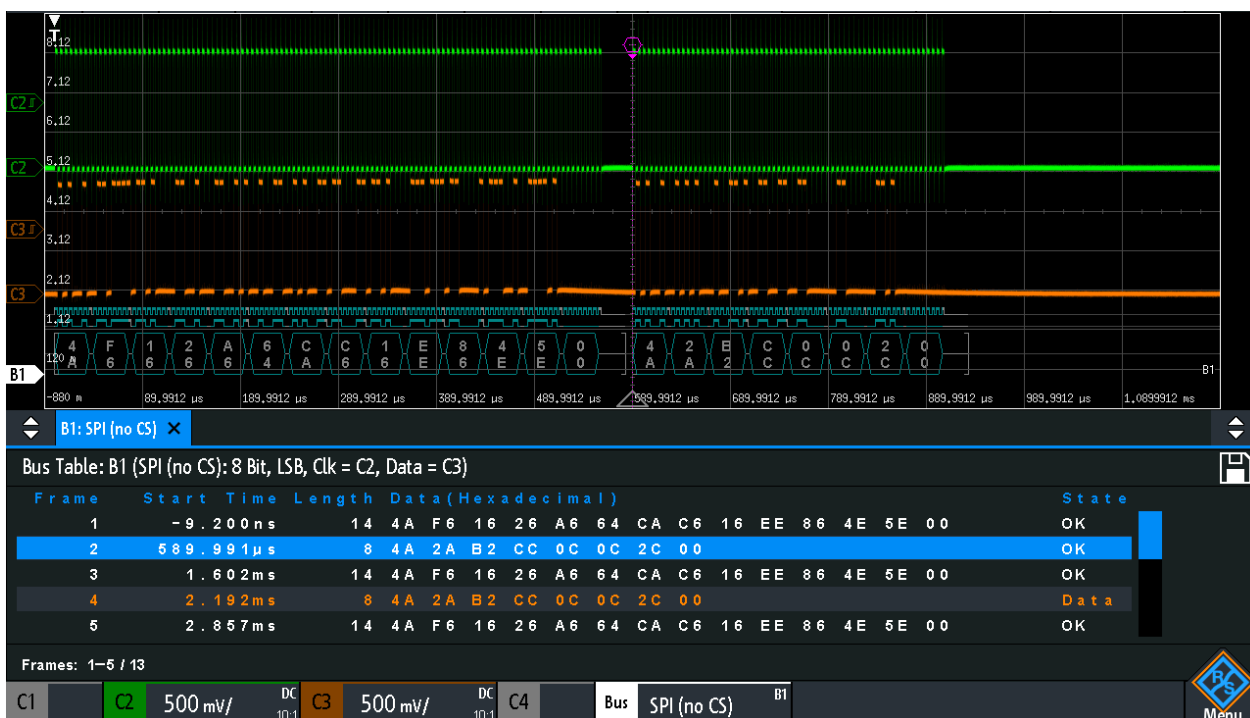

Figure 12-8: Decoded SPI (no CS) signal with Bus Table. The first frame has fourteen words and the second eight words.

Table 12-1: Content of the SPI bus table

Column	Description
Start time	Time of the frame start in relation to the trigger point
Length	Number of words in the frame
Data	Hexadecimal values of the data words
State	Overall state of the frame

Remote commands are described in [Chapter 16.11.2.4, "SPI - Decode Results"](#), on page 585.

12.3 I²C (Option R&S RTM-K1)

The Inter-Integrated Circuit is a simple, low-bandwidth, low-speed protocol used for communication between on-board devices, for example, in LCD and LED drivers, RAM, EEPROM, and others.

- [The I²C Protocol](#).....249
- [I²C Configuration](#).....250
- [I²C Trigger](#).....252
- [I²C Decode Results](#)255
- [I²C Label List](#).....256

12.3.1 The I²C Protocol

This chapter provides an overview of protocol characteristics, data format, address types and trigger possibilities. For detailed information, read the "I²C-bus specification and user manual" available on the NXP manuals web page at <http://www.nxp.com/>.

I²C characteristics

Main characteristics of I²C are:

- Two-wire design: serial clock (SCL) and serial data (SDA) lines
- Master-slave communication: the master generates the clock and addresses the slaves. Slaves receive the address and the clock. Both master and slaves can transmit and receive data.
- Addressing scheme: each slave device is addressable by a unique address. Multiple slave devices can be linked together and can be addressed by the same master.
- Read/write bit: specifies if the master reads (=1) or writes (=0) the data.
- Acknowledge: takes place after every byte. The receiver of the address or data sends the acknowledge bit to the transmitter.

The R&S RTM3000 supports all operating speed modes: high-speed, fast mode plus, fast mode, and standard mode.

Data transfer

The format of a simple I²C message (frame) with 7-bit addressing consists of the following parts:

- Start condition: a falling slope on SDA while SCL is high
- 7-bit address of the slave device that either is written to or read from
- R/W bit: specifies if the data is written to or read from the slave
- ACKnowledge bits: is issued by the receiver of the previous byte if the transfer was successful
Exception: At read access, the master terminates the data transmission with a NACK bit after the last byte.
- Data: several data bytes with an ACK bit after every byte
- Stop condition: a rising slope on SDA while SCL is high

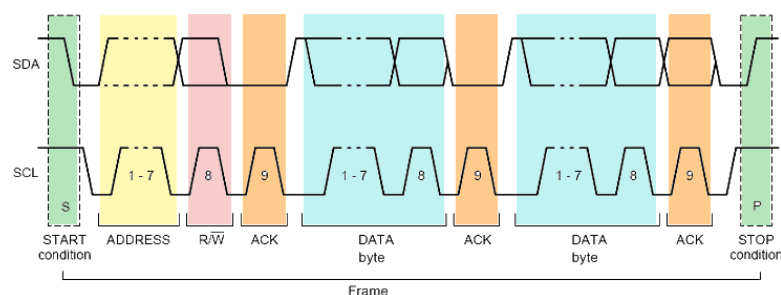

Figure 12-9: I²C writes access with 7-bit address

Address types: 7-bit and 10-bit

Slave addresses can be 7 bits or 10 bits long. A 7-bit address requires 1 byte, 7 bits for the address followed by the R/W bit.

A 10-bit address for write access requires 2 bytes: the first byte starts with the reserved sequence 11110, followed by the two MSB of the address and the write bit. The second byte contains the remaining 8 LSB of the address. The slave acknowledges each address byte.

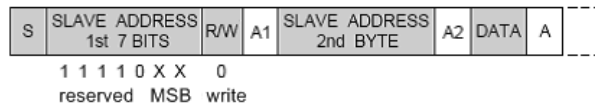

Figure 12-10: 10-bit address, write access

A 10-bit address for read access requires 3 bytes. The first 2 bytes are identical to the write access address. The third byte repeats the address bits of the first byte and sets the read bit.

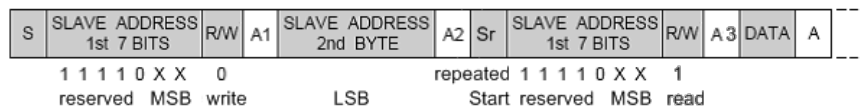

Figure 12-11: 10-bit address, read access

Trigger

The R&S RTM3000 can trigger on various parts of I²C messages. The data and clock lines must be connected to the input channels, triggering on math and reference waveforms is not possible.

You can trigger on:

- Start or stop condition
- Repeated start condition
- Transfer direction (read or write)
- Bytes with missing acknowledge bit
- Specific slave address
- Specific data pattern in the message

12.3.2 I²C Configuration

The correct setup of the protocol parameters and the threshold is the condition for decoding the signal.

To set up and decode an I²C signal

1. Press the [Protocol] key in the Analysis area of the front panel.
2. Select the bus that you want to use: B1, B2, B3 or B4.

3. Select the "Bus Type" = I2C.
4. Select "Configuration".
5. Select the "SCL", the channel to which the clock line is connected.
6. Select the "SDA", the channel to which the data line is connected.
7. Set the threshold. Use one of these methods:
 - Tap "Find Threshold". The instrument evaluates the signal and sets the threshold.
 - Enter the threshold value in the numeric field.
8. In the "Bus" menu, enable "Decode".

I²C configuration settings

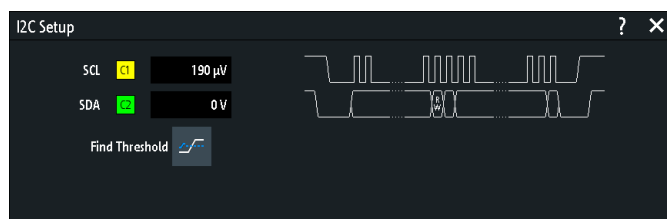

Figure 12-12: I2C setup dialog

SCL.....	251
SDA.....	251
Threshold, Find Threshold.....	251

SCL

Selects the source channel to which the clock line is connected.

If the MSO option R&S RTM-B1 is installed, you can use logic channels as source.

Remote command:

[BUS : I2C : CLOck : SOURce](#) on page 589

SDA

Selects the source channel to which the data line is connected.

If the MSO option R&S RTM-B1 is installed, you can use logic channels as source.

Remote command:

[BUS : I2C : DATA : SOURce](#) on page 589

Threshold, Find Threshold

Set the signal threshold for the source channel. Enter a value, or use "Find Threshold" to set the threshold to the middle reference level of the measured amplitude.

For analog channels, you can find the value also in the "Vertical" menu > "Channel <n>" > "Threshold"

For logic channels, you can find the value also in the "Logic" menu > "Technology".

Remote command:

[CHANnel<m>:THReshold](#) on page 421

[CHANnel<m>:THReshold:FINDlevel](#) on page 422

[DIGital<m>:THReshold](#) on page 739

12.3.3 I²C Trigger

Before you set up the trigger, make sure that the bus is configured correctly. See [Chapter 12.3.2, "I²C Configuration"](#), on page 250.

To trigger on I²C signals:

1. Press the [Protocol] key in the Analysis area of the front panel.
2. Select the bus that is configured for I2C.
3. Select "Trigger".

This selection has several effects:

 - Enables decoding, if necessary.
 - Sets the "Trigger Type" to "Serial Bus" and the trigger source to the selected bus.
 - Displays the trigger conditions in the dialog box, below the protocol setup.
4. At "I2C Trigger", select the required trigger type:
 - "Start": beginning of the message
 - "Stop": end of the message
 - "Restart": repeated start condition
 - "No Ack (Missing Ack)": transfer of data bits is not acknowledged
 - "Address and Data": address pattern and/or up to 3 data bytes
5. If "Identifier" or "Identifier and Data" is selected, the CAN trigger setup dialog expands to define the serial pattern.
6. If "Address and Data" is selected, the I²C trigger setup dialog expands to define the serial patterns.

I2C trigger settings

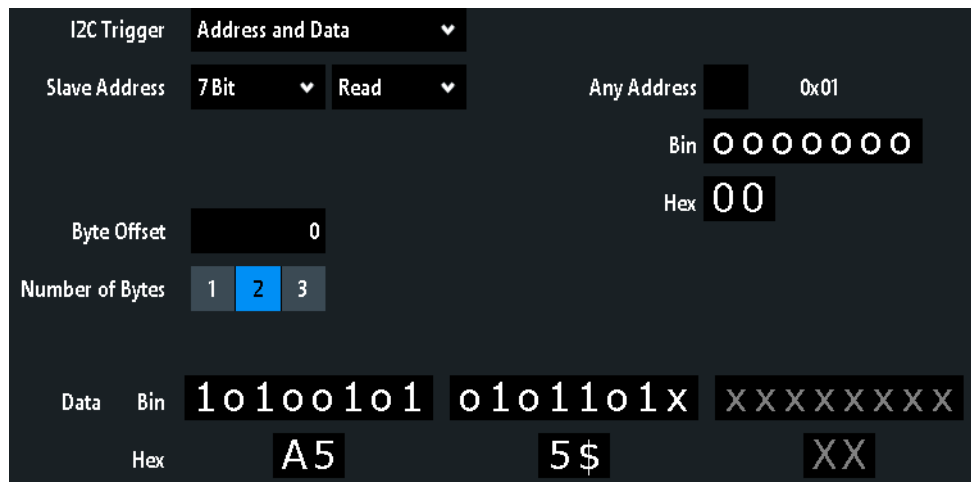

Figure 12-13: Trigger setup dialog to trigger on a combination of address and data

- A5 = Hex value of the 1st byte, with the binary value 10100101
- 5\$ = Hex value of the 2nd byte, where the 1st nibble has the binary value 0101 and the 2nd nibble is represented by the "\$" character, as it includes one "X" bit (don't care)
- XX (gray) = The 3rd byte is not contained in the specified pattern

I2C Trigger..... 253

Slave Address..... 254

Symbolic ID..... 254

Data condition..... 254

- └ Byte Offset..... 254
- └ Number of Bytes..... 254
- └ Data: Bin / Hex pattern..... 255

I2C Trigger

Selects the trigger condition.

- "Start" Sets the trigger to the start of the message. The start condition is a falling slope on SDA while SCL is high.
- "Stop" Sets the trigger to the end of the message. The stop condition is a rising slope on SDA while SCL is high.
- "Restart" Sets the trigger to a repeated start - when the start condition occurs without previous stop condition. This can happen when a master sends multiple messages without releasing the bus.
- "No Ack (Missing Ack)" Missing acknowledgement: the instrument triggers, if the slave does not send the acknowledge bit. Acknowledging takes place after every byte. If the transfer failed, at the moment of the acknowledge bit, the SDA line is on high level during the high period of the clock pulse.
- "Address and Data" Sets the trigger to an address or data pattern, or a combination of both.
See "Slave Address" on page 254 and "Data condition" on page 254.

Remote command:

[TRIGger:A:I2C:MODE](#) on page 590

Slave Address

Sets the slave address to be triggered on. If you want to trigger only on a data pattern and the address is not relevant, enable "Any Address".

To specify the slave address, set the following properties:

- Set the length of the slave address: "7Bit" or "10Bit".
- Toggle the trigger condition between "Read" and "Write" access of the master. The read/write bit is the 8th bit of the first address byte of a frame.
- Set the address of the slave device: enter the binary or hexadecimal address value. You need an exact address, "X" bits (don't care) are not allowed.

Remote command:

[TRIGger:A:I2C:AMODE](#) on page 591

[TRIGger:A:I2C:ACCess](#) on page 590

[TRIGger:A:I2C:ADDRess](#) on page 591

Symbolic ID

If a label list with symbolic names was loaded and applied in the bus configuration, you can select a symbolic name from the list instead of specifying the address. When you select a name, the address fields are update with its address value.

Data condition

The data condition consists of the following settings:

- Byte offset (position of the data pattern)
- Length of the data pattern
- Data pattern, see "[Bin / Hex pattern](#)" on page 272

If you want to trigger only on an address, and the data is not relevant, set all data bits to "X".

Byte Offset ← Data condition

Sets the number of offset bytes to be ignored after the end of the address bytes. The first byte of interest is the first byte after the offset bytes.

The minimum offset is 0 Bytes, the maximum offset is 4,095 Bytes.

Remote command:

[TRIGger:A:I2C:POFFset](#) on page 592

Number of Bytes ← Data condition

Sets the number of full bytes you want to trigger on. Maximum 3 bytes are possible.

Note: Entering data bits beyond the specified length of the pattern automatically adjusts the "Number of Bytes" to include defined bytes.

Remote command:

[TRIGger:A:I2C:PLENght](#) on page 592

Data: Bin / Hex pattern ← Data condition

Defines the data pattern in binary and hexadecimal format. To set an individual binary bit or hex nibble (half byte), tap it and enter the value on the on-screen keypad. The maximum pattern length is 3 bytes.

Remote command:

[TRIGger:A:I2C:PATtern](#) on page 591

12.3.4 I²C Decode Results

When the configuration of the serial bus is complete, the signal can be decoded:

1. In the "Bus" menu, enable "Decode".
2. In the "Display" menu, select the result display settings.
See [Chapter 12.1.2, "Displaying Decode Results"](#), on page 233.
3. In the "Bus Table" menu, enable the "Bus Table". Adjust the table settings.
See also: [Chapter 12.1.3, "Bus Table: Decode Results"](#), on page 234

The instrument captures and decodes the signal according to the protocol definition and the configuration settings.

The color-coding of the various protocol sections and errors simplifies the interpretation of the visual display. The decode information condenses or expands, depending on the horizontal scale. Various data formats are available to show the result values.

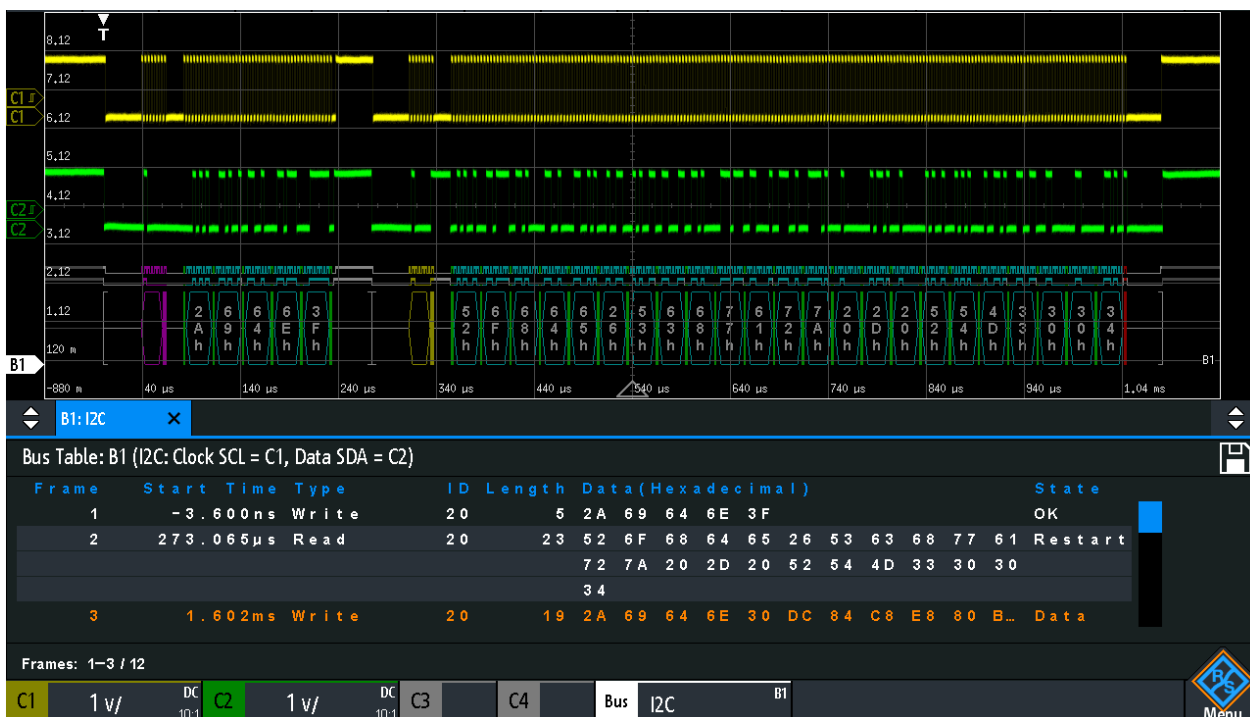

Figure 12-14: Decoded I²C signal with bus table, trigger on frame start

Gray brackets = start and end of the frame
 Violet = address
 Blue = correct data words
 Green = acknowledge bit, ok

Table 12-2: Content of the I²C frame table

Column	Description
Start time	Time of the frame start in relation to the trigger point
Type	Value of the R/W bit, read or write access
ID	Hexadecimal value of the address
Length	Number of words in the frame
Data	Hexadecimal values of the data words
State	Overall state of the frame

Remote commands are described in [Chapter 16.11.3.3, "I²C - Decode Results"](#), on page 592.

12.3.5 I²C Label List

Label lists are protocol-specific. Label lists for I²C are available in CSV and PTT format.

An I²C label file contains three values for each address:

- Address type, 7-bit or 10-bit long
- Address value
- Symbolic label: name of the address, specifying its function in the bus network.

Example: I²C PTT file

```
# -----
@FILE_VERSION = 1.00
@PROTOCOL_NAME = i2c
# -----
# Labels for I2C protocol
# Column order: Identifier type, Identifier value, Label
# -----
7,0x1E,Voltage
7,38h,Pressure
7,2Ah,Temperature
7,16h,Speed
7,118,Acceleration
7,07h,HighSpeed_Master_0x3
7,51h,EEPROM
10,3A2h,DeviceSetup
10,1A3h,GatewayStatus
10,06Eh,LeftSensor
# -----
```

For general information on label lists, see [Chapter 12.1.5, "Label List"](#), on page 237.

Label List: I2C (Imported on: 2017-03-30; 16:27)

Symbolic Label	ID / Addr
Acceleration	0 x 7 6
DeviceSetup	0 x 3 A 2
EEPROM	0 x 5 1
GatewayStatus	0 x 1 A 3
HighSpeed_Master_0x3	0 x 0 7
LeftSensor	0 x 0 6 E
Pressure	0 x 3 8
Speed	0 x 1 6
Temperature	0 x 2 A
Voltage	0 x 1 E

Figure 12-15: Label list for I2C

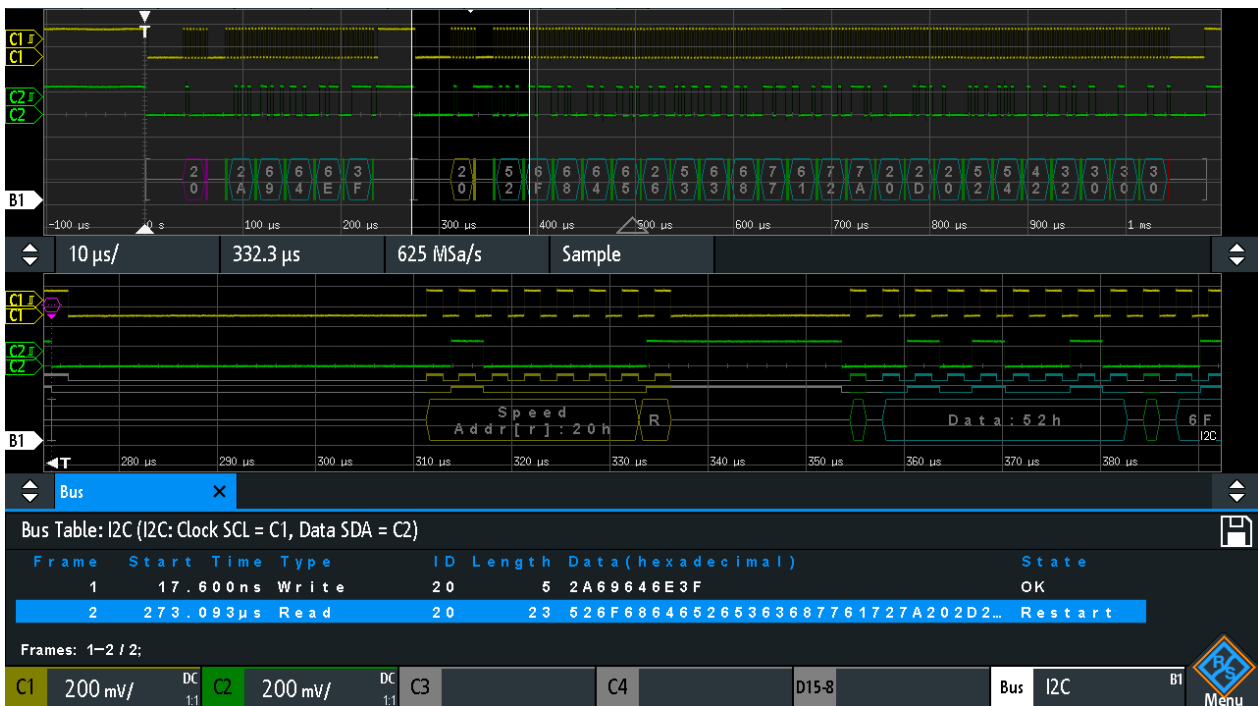

Figure 12-16: Decoded I2C signal with applied label list and zoom on second frame

12.4 UART / RS232 (Option R&S RTM-K2)

- [The UART / RS232 Interface](#)..... 258
- [UART Configuration](#)..... 258
- [UART Trigger](#)..... 261
- [UART Decode Results](#) 263

12.4.1 The UART / RS232 Interface

The Universal Asynchronous Receiver/Transmitter UART converts a word of data into serial data, and vice versa. It is the base of many serial protocols like of RS-232. The UART uses only one line, or two lines for transmitter and receiver.

Data transfer

The data is transmitted in symbols, also referred to as words or characters. Each symbol consists of a start bit, several data bits, an optional parity bit, and one or more stop bits. Several symbols can form a frame, or package. The end of a frame is marked by a pause between two symbols.



Figure 12-17: Bit order in a UART word (symbol)

- The start bit is a logic 0.
- The stop bits and the idle state are always logic 1.

The UART protocol has no clock for synchronization. The receiver synchronizes by means of the start and stop bits, and the bit rate that must be known to the receiver.

Trigger

The R&S RTM3000 can trigger on specified parts of UART serial signals:

- Start bit
- Frame start
- A specified symbol
- Parity errors, and breaks
- Frame errors
- A serial pattern at any or a specified position

12.4.2 UART Configuration

The correct setup of the protocol parameters and the threshold is the condition for decoding the signal.

To set up and decode a UART signal

1. Press the [Protocol] key in the Analysis area of the front panel.
2. Select the bus that you want to use: B1, B2, B3 or B4.
3. Select the "Bus Type" = UART.
4. Select "Configuration".
5. Select the "TX / RX / Source", the channel to which the input signal is connected.
6. Set the threshold. Use one of the following methods:
 - Tap "Find Threshold". The instrument evaluates the signal and sets the threshold.
 - Enter the threshold value in the numeric field.
7. Set the other signal parameters according to the signal characteristics.
8. In the "Bus" menu, enable "Decode".

UART configuration settings

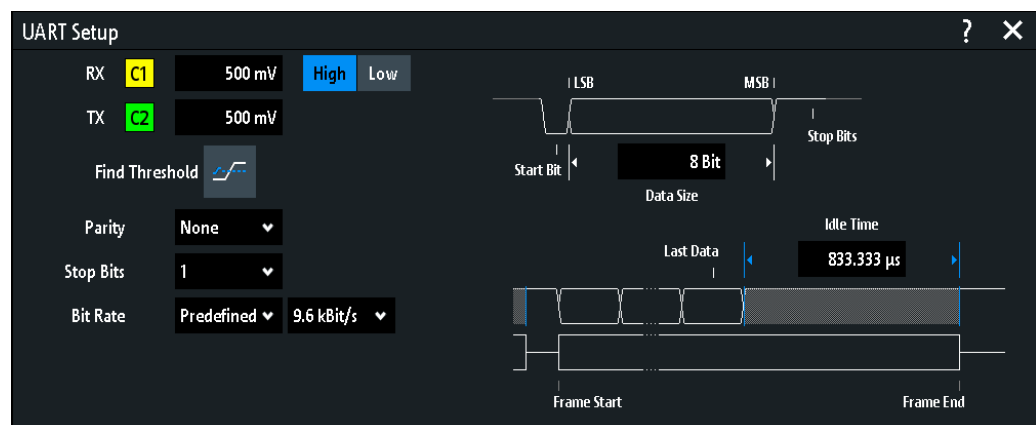

Figure 12-18: UART setup dialog

TX / RX / Source	259
Polarity	260
Threshold, Find Threshold	260
Parity	260
Stop Bits	260
Bit Rate	260
Data Size	261
Idle Time	261

TX / RX / Source

Select the input channel of the UART lines. Input channels are the receive line (RX), and the optional transmit line (TX).

If the MSO option R&S RTM-B1 is installed, you can use logic channels as source.

Note: TX is available only on bus 1 and bus 3. On bus 2 and bus 4, you can set only one "Source" line. The TX line occupies a second bus line. Thus, if TX is used on bus 1 or bus 3, bus 2 or bus 4 is not available respectively.

Remote command:

[BUS:UART:RX:SOURce = BUS:UART:DATA:SOURce](#) on page 600

[BUS:UART:TX:SOURce](#) on page 600

Polarity

Selects if the transmitted data is high active (high = 1) or low active (low = 1). The setting affects both lines.

High active is used, for example, for control signals, while low active is defined for data lines (RS-232).

Remote command:

[BUS:UART:DATA:POLarity](#) on page 600

[BUS:UART:POLarity](#) on page 600

Threshold, Find Threshold

Set the signal threshold for the source channel. Enter a value, or use "Find Threshold" to set the threshold to the middle reference level of the measured amplitude.

For analog channels, you can find the value also in the "Vertical" menu > "Channel <n>" > "Threshold"

For logic channels, you can find the value also in the "Logic" menu > "Technology".

Remote command:

[CHANnel<m>:THReshold](#) on page 421

[CHANnel<m>:THReshold:FINDlevel](#) on page 422

[DIGital<m>:THReshold](#) on page 739

Parity

Defines the optional parity bit that is used for error detection.

"None" No parity bit is used.

"Even" The parity bit is set to "1" if the number of data bits set to "1" is odd. Adding the parity bit makes the data word's parity even.

"Odd" The parity bit is set to "1" if the number of data bits set to "1" is even. Adding the parity bit makes the data word's parity odd.

Remote command:

[BUS:UART:PARity](#) on page 601

Stop Bits

Sets the number of stop bits: 1 or 1.5 or 2 stop bits are possible.

Remote command:

[BUS:UART:SBIT](#) on page 601

Bit Rate

Sets the number of transmitted bits per second.

"Predefined" Selects from a list of predefined bit rates between 300 Bit/s and 1 MBit/s.

"User" Specifies an individual bit rate with values between 150 and 39,062,500.

Remote command:

[BUS:UART:BAUDrate](#) on page 601

Data Size

Sets the number of data bits of a word in a range from 5 bits to 9 bits.

Remote command:

[BUS:UART:SSIZE](#) on page 601

Idle Time

Sets the minimal time between two data frames (packets), that is, between the last stop bit and the start bit of the next frame.

Remote command:

[BUS:UART:BITime](#) on page 602

12.4.3 UART Trigger

Before you set up the trigger, make sure that the bus is configured correctly. See [Chapter 12.4.2, "UART Configuration"](#), on page 258.

To trigger on UART signals:

1. Press the [Protocol] key in the Analysis area of the front panel.
2. Select the bus that is configured for UART.
3. Select "Trigger".

This selection has several effects:

- Enables decoding, if necessary.
- Sets the "Trigger Type" to "Serial Bus" and the trigger source to the selected bus.
- Displays the "UART Trigger" condition in the dialog box, below the protocol setup.

4. In the menu, select the "Source".
5. At "UART Trigger", select the required trigger condition:
 - "Start Bit" or "Frame Start": next start bit or first start bit after idle time
 - "Frame Start"
 - "Frame Error"
 - "Symbol <n>": frame number in a data stream
 - "Break": a start bit not followed by a stop bit
 - "Parity Error"
 - "Pattern": serial pattern of 1, 2, 3 or 4 symbols at a defined position in the data stream
 - "Any Symbol": pattern of data bits anywhere in a data stream

- If "Pattern" or "Any Symbol" is selected, the UART trigger setup dialog expands to define the serial pattern or the symbol.

UART trigger settings

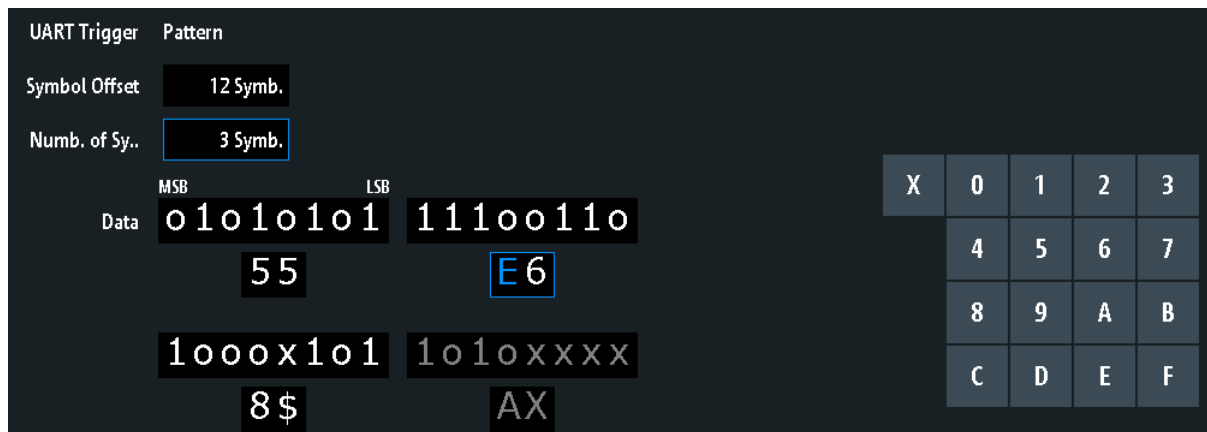

Figure 12-19: Trigger setup dialog with an example of a UART serial pattern

- 55 = Hex value of the 1st symbol, with the binary value 01010101
- E6 = Hex value of the 2nd symbol, with the binary value 11100110
- E (blue) = Selected nibble in the 2nd symbol. The blue color indicates that the keypad is active for this nibble.
- 8\$ = Hex value of the 3rd symbol, where the 1st nibble has the binary value 1000 and the 2nd nibble is represented by the "\$" character, as it includes one "X" bit (don't care)
- AX (gray) = The 4th symbol is not contained in the specified pattern

Source.....262

UART Trigger..... 262

Symbol Offset.....263

Numb. of Symb..... 263

Data.....263

Source

Selects the transmitter or receiver line as trigger source.

Remote command:

[TRIGger:A:SOURce:UART](#) on page 602

UART Trigger

Selects the trigger condition.

- "Start Bit" Sets the trigger to the start bit. The start bit is the first logical 0 after a stop bit.
- "Frame Start" Sets the trigger to the beginning of a frame. The frame start is the first start bit after the idle time.
- "Frame Error" The instrument triggers, if a frame error occurs.
- "Symbol <n>" Sets the trigger to the specified symbol - the n-th word - in a frame (package). Specify the "Symbol Offset" on page 263.
- "Break" Triggers if a start bit is not followed by a stop bit, the data line remains at logic 0 for longer than a UART word.

"Parity Error"	Triggers on a parity error indicating a transmission error.
"Pattern"	Triggers on a data pattern at a specified position. The pattern setup consists of the " Symbol Offset " on page 263, the " Numb. of Symb. " on page 263, and the " Data " on page 263.
"Any Symbol"	Triggers on a pattern that occurs in one symbol at any position in a frame. See " Data " on page 263.

Remote command:

[TRIGger:A:UART:MODE](#) on page 602

Symbol Offset

Sets the number of symbols at the beginning of the package to be ignored before the serial pattern. The first symbol of interest is the first byte after the offset symbols.

The minimum offset is 0 symbols, the maximum offset is 4,095 symbols.

Remote command:

[TRIGger:A:UART:POFFset](#) on page 603

Numb. of Symb.

Sets the number of symbols (full bytes) you want to trigger on. The minimum is 1 symbol, a maximum of 4 symbols is possible.

Note: Entering data bits beyond the specified length of the pattern automatically adjusts the "Number of Bytes" to include all specified bytes.

Remote command:

[TRIGger:A:UART:PLENght](#) on page 603

Data

Specifies the data pattern if "UART Trigger" is set to "Pattern" or "Any Symbol".

An example of pattern definition is shown in [Figure 12-19](#).

To enter the binary value of any bit, tap this bit. To enter the hexadecimal value, tap one of the nibbles (half byte) in the lower data line.

If a nibble (half byte) contains 1, 2 or 3 "X" bits (don't care), the nibble value is represented by the character "\$". If all 4 bits of a nibble are "X", the nibble itself is "don't care", represented by the character "X".

Remote command:

[TRIGger:A:UART:PATTern](#) on page 603

12.4.4 UART Decode Results

When the configuration of the serial bus is complete, the signal can be decoded:

1. In the "Bus" menu, enable "Decode".
2. In the "Display" menu, select the result display settings.
See [Chapter 12.1.2, "Displaying Decode Results"](#), on page 233.
3. In the "Bus Table" menu, enable the "Bus Table". Adjust the table settings.

See also: [Chapter 12.1.3, "Bus Table: Decode Results"](#), on page 234

The instrument captures and decodes the signal according to the protocol definition and the configuration settings.

The color-coding of the various protocol sections and errors simplifies the interpretation of the visual display. The decode information condenses or expands, depending on the horizontal scale. Various data formats are available to show the result values.

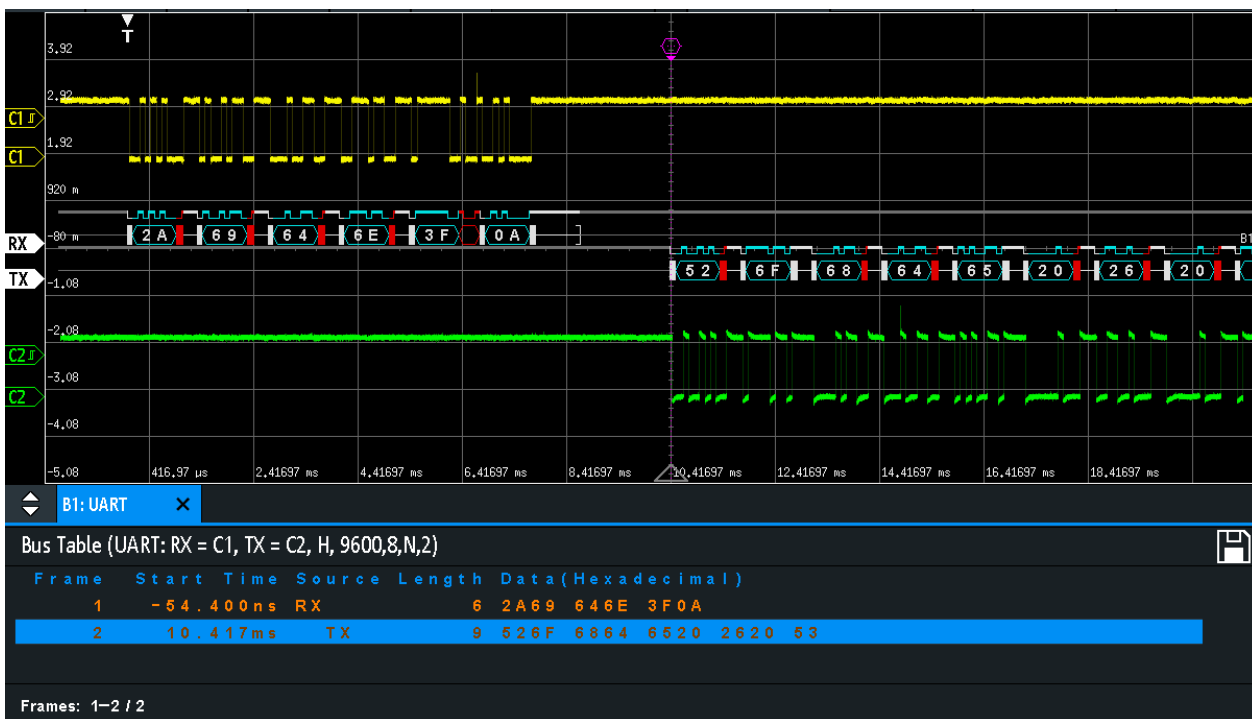

Figure 12-20: Decoded UART signal

The figure above shows six frames of a UART signal and the "Bus Table".

Table 12-3: Content of the UART frame table

Column	Description
Start time	Time of the frame start in relation to the trigger point
Data	Hexadecimal values of the data words
State	Overall state of the frame

Remote commands are described in [Chapter 16.11.4.3, "UART - Decode Results"](#), on page 604.

12.5 CAN (Option R&S RTM-K3)

CAN is the Controller Area Network, a bus system designed by Bosch for use within automotive network architecture, for example, for brake, power train and engine man-

agement. Today, it is also used in many other systems, for example, in industrial machines, aerospace, subsea, merchant marine.

• The CAN Protocol	265
• CAN Configuration	266
• CAN Trigger	268
• CAN Decode Results	272
• Search on Decoded CAN Data	274
• CAN Label List	276

12.5.1 The CAN Protocol

This chapter provides an overview of the protocol characteristics, frame types, information transfer and message formats.

The CAN 2.0 specification defines two formats: the base CAN (version 2.0A) with an 11-bit identifier and the extended CAN (version 2.0B) with a 29-bit identifier. Based on these specifications the CAN standard ISO 11898-1 was released, in 1993.

CAN characteristics

Main characteristics of CAN are:

- Differential signaling.
- Transmission over two wires, high and low.
- Multi-master, which means that any node can begin to transmit a message, when a bus is free.
- Bitwise arbitration.

Arbitration

Information transfer is done by carrier sense multiple access/bitwise arbitration (CSMA/BA). Each node waits for a certain inactive period before it tries to send a message. Collisions are resolved through a bitwise arbitration that is non-destructive.

Each message has a priority which is implied in the identifier value - the lower the value, the higher the priority. A dominant bit from the message with highest priority overwrites the recessive bits on the bus. If a node detects that the bus is already receiving a message that has a higher priority, it stops the transmission and waits for the current transmission to end before retransmitting.

Frame types

The CAN protocol defines the following types of frames:

- Data: used for information transmission.
- Remote: used for information request. The destination node sends this frame to the source to request data. This type of frame is only used by CAN.
- Error: indicates that a bus node has detected transmission error.
- Overload: used from a bus node to request a transmission delay.

CAN data message format

The CAN protocol defines two formats for the data frame: the base frame format and the extended frame format. The data frames are built as follows:

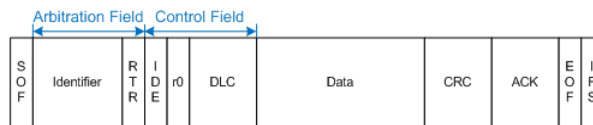

Figure 12-21: CAN basic frame

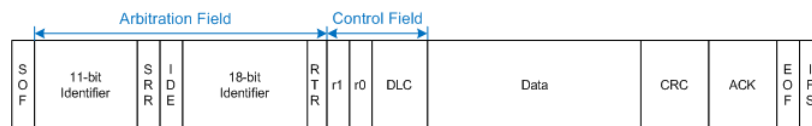

Figure 12-22: CAN extended frame

The following fields, compose the base/extended frame format:

- **SOF**: start of frame. 1 dominant bit that marks the beginning of the message.
- **Identifier**: 11/18-bit identifier. Contains information about the priority of the message. CAN base frames have an 11-bit identifier while CAN extended frames have a total of 29 bits identifier.
- **RTR**: remote transmission request bit. Differentiates between base and extended frames. It is dominant for base data frames and recessive for extended data frames.
- **SRR**: substitute remote request. Only present in extended CAN frames at the position of the RTR bit in base frames.
- **IDE**: identifier extension bit. It helps to distinguish between a base and extended data frame. It is dominant for data frames and recessive for remote frames
- **r0/r1**: reserved bits for possible future use.
- **DLC**: data length code. Defines how many bytes of data follow.
- **Data**: up to 8 bytes of data can be transmitted for CAN.
- **CRC**: cyclic redundancy check. Checks the integrity of the frame contents.
- **ACK**: acknowledgement. This is a recessive bit that is overwritten by the node, if the message was transmitted correctly.
- **EOF**: end-of-frame: marks the end of the message.
- **IFS**: interframe space. Separates a data or remote frame from the preceding frames.

12.5.2 CAN Configuration

The correct setup of the protocol parameters and the threshold is the condition for decoding the signal.

To set up and decode a CAN signal

1. Press the [Protocol] key in the Analysis area of the front panel.
2. Select the bus that you want to use: B1, B2, B3 or B4.
3. Select the "Bus Type" = CAN.
4. Select "Configuration".
5. Select the "Source", the channel to which the input signal is connected.
6. Set the threshold. Use one of the following methods:
 - Tap "Find Threshold". The instrument evaluates the signal and sets the threshold.
 - Enter the threshold value in the numeric field.
7. Set the other signal parameters according to the signal characteristics. All settings are described below.
8. In the "Bus" menu, enable "Decode".

CAN configuration settings

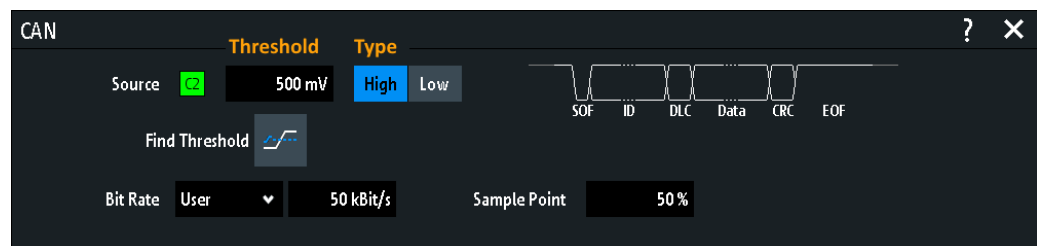

Source.....	267
Threshold, Find Threshold.....	267
Type.....	268
Bit Rate.....	268
Sample Point.....	268

Source

Sets the source of the data line. All channel waveforms can be used.

If the MSO option R&S RTM-B1 is installed, you can use logic channels as source.

Remote command:

[BUS : CAN : DATA : SOURce](#) on page 609

Threshold, Find Threshold

Set the signal threshold for the source channel. Enter a value, or use "Find Threshold" to set the threshold to the middle reference level of the measured amplitude.

For analog channels, you can find the value also in the "Vertical" menu > "Channel <n>" >"Threshold"

For logic channels, you can find the value also in the "Logic" menu > "Technology".

Remote command:

[CHANnel<m>:THReshold](#) on page 421

[CHANnel<m>:THReshold:FINDlevel](#) on page 422

[DIGital<m>:THReshold](#) on page 739

Type

Selects the CAN-High or CAN-Low line. CAN uses both lines for differential signal transmission.

If you measure with a differential probe, connect the probe to both CAN-H and CAN-L lines and select "High".

If you use a single-ended probe, connect the probe to either CAN_L or CAN_H and select "High" or "Low" accordingly.

Remote command:

[BUS:CAN:TYPE](#) on page 609

Bit Rate

Sets the number of transmitted bits per second. The maximum bit rate for High Speed CAN is 1 Mbit/s. The bit rate is uniform and fixed for a given CAN bus.

"Predefined" To select a bit rate from the list of predefined values, set "Bit rate" to "Predefined" and select a value from the list.

"User" To set another value, set "Bit rate" to "User" and enter a bit/s value.

Remote command:

[BUS:CAN:BITRate](#) on page 610

Sample Point

Sets the position of the sample point within the bit in percent of the nominal bit time. The sample point divides the nominal bit period into two distinct time segments, which are used for resynchronization of the clock.

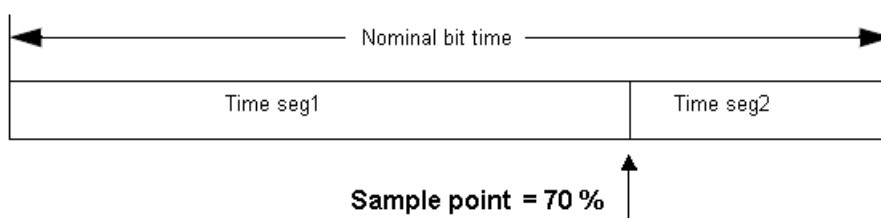

The CAN bus interface uses an asynchronous transmission scheme. The standard specifies a set of rules to resynchronize the local clock of a CAN node to the message.

Remote command:

[BUS:CAN:SAMPlepoint](#) on page 610

12.5.3 CAN Trigger

Before you set up the trigger, make sure that the bus is configured correctly. See [Chapter 12.5.2, "CAN Configuration"](#), on page 266.

To trigger on CAN signals:

1. Press the [Protocol] key in the Analysis area of the front panel.
2. Select the bus that is configured for CAN.
3. Select "Trigger".

This selection has several effects:

- Enables decoding, if necessary.
- Sets the "Trigger Type" to "Serial Bus" and the trigger source to the selected bus.
- Displays the "CAN Trigger" condition in the dialog box, below the protocol setup.

4. At "CAN Trigger", select the required trigger type:
 - "Start of Frame": first edge of synchronization bit
 - "End of Frame": frame number in a data stream
 - "Frame": error, overload, data or remote frame
 - "Error": stuff bit, form, acknowledgment, CRC
 - "Identifier": specific message identifier or identifier range
 - "Identifier and Data": combination of identifier and data condition
5. If "Identifier" or "Identifier and Data" is selected, the CAN trigger setup dialog expands to define the serial pattern.

CAN trigger settings

The screenshot shows the CAN Trigger setup dialog with the following settings:

- CAN Trigger:** Identifier and Data
- Frame Type:** Remote
- ID Type:** 29Bit
- Compare:** Greater Than
- Identifier:** Bin: 0100101011000101100000111111; Hex: 0958583F
- Data:** 6Byte
- Compare:** Equal
- Data Pattern Grid:**

X	0	1	2	3
4	5	6	7	
8	9	A	B	
C	D	E	F	

Figure 12-23: Trigger setup dialog with an example of CAN identifier and data patterns

"CAN Trigger" = trigger on "Identifier and Data"

"Identifier" = trigger on 29-bit identifiers greater than the specified identifier

"Data" = trigger on the specified 6-byte data pattern

0 (blue) = Selected nibble in the 2ndbyte of the data pattern, where the blue color indicates that the keypad is active for this nibble

CAN Trigger

Selects the trigger mode.

"Start of Frame" Triggers on the first edge of the dominant SOF bit (synchronization bit).

"End of Frame"	Triggers on the end of the frame (7 recessive bits).
"Frame"	Triggers on the frame type that is selected with "Frame" See: "Frame" on page 270.
"Error"	Triggers on a frame error. An error frame is sent by a node that has detected an error. See: "Error" on page 270.
"Identifier"	Triggers on a specific message identifier or an identifier range. If a label list with node names was loaded and applied in the bus configuration, you can select simply the "Symbolic ID" instead of entering the numeric identifier. See: "Identifier condition" on page 271.
"Identifier and Data"	Triggers on a combination of identifier and data condition. The instrument triggers at the end of the last byte of the specified data pattern. See: "Identifier condition" on page 271 and "Data condition" on page 272.

Remote command:

[TRIGger:A:CAN:TYPE](#) on page 611

Frame

Select the frame type to be triggered on.

"Data"	Frame for data transmission. The identifier format ("ID Type") is also considered.
"Remote"	A remote frame initiates the transmission of data by another node. The frame format is the same as of data frames, but without the data field. The identifier format ("ID Type") is also considered.
"Data or Remote"	Triggers on remote frames and on data frames. The identifier format ("ID Type") is also considered.
"Error"	Triggers on any error frame.
"Overload"	An overload frame is sent by a node that needs a delay between data and/or remote frames.

Remote command:

[TRIGger:A:CAN:FTYPE](#) on page 611

ID Type

Selects the length of the identifier: 11 bit for CAN base frames or 29 bits for CAN extended frames. Select "Any" if the identifier type is not relevant.

Remote command:

[TRIGger:A:CAN:ITYPe](#) on page 611

Error

Identifies various errors in the frame. You can select one or more error types as trigger condition.

Remote command:

[TRIGger:A:CAN:TYPE](#) on page 611

Stuff Bit ← Error

The following frame segments are coded by the bit stuffing method:

- Start of frame
- Arbitration field
- Control field
- Data field
- CRC sequence

The transmitter automatically inserts a complementary bit into the bitstream when it detects five consecutive bits of identical value in the bitstream to be transmitted. A stuff error occurs when the 6th consecutive equal bit level in the mentioned fields is detected.

Remote command:

[TRIGger:A:CAN:BITSterror](#) on page 613

Form ← Error

A form error occurs when a fixed-form bit field contains one or more illegal bits.

Remote command:

[TRIGger:A:CAN:FORMerror](#) on page 614

Acknowledge ← Error

An acknowledgment error occurs when the transmitter does not receive an acknowledgment - a dominant bit during the "Ack" slot.

Remote command:

[TRIGger:A:CAN:ACKerror](#) on page 613

CRC ← Error

CAN uses the Cyclic Redundancy Check (CRC), which is a complex checksum calculation method. The transmitter calculates the CRC and sends the result in the CRC sequence. The receiver calculates the CRC in the same way. A CRC error occurs when the calculated result differs from the received value in the CRC sequence.

Remote command:

[TRIGger:A:CAN:CRCErrror](#) on page 613

Identifier condition

The identifier condition consists of the following settings:

- [ID Type](#)
- Comparison
- Identifier value

Compare ← Identifier condition

Sets the identifier comparison condition: If the identifier pattern contains at least one X (do not care), you can trigger on values equal or not equal to the specified value. If the pattern contains only 0 and 1, you can also trigger on a range greater than or lower than the specified value.

Remote command:

[TRIGger:A:CAN:ICONdition](#) on page 612

Bin / Hex pattern ← Identifier condition

Defines the identifier or data pattern in binary and hexadecimal format. To set an individual binary bit or hex nibble (half byte), tap it and enter it via the on-screen keypad.

"Bin"	String containing the binary pattern with a maximum of 64 bits. Characters 0, 1 and X are allowed.
"Hex"	String containing the hexadecimal pattern with a maximum of 8 bytes. Characters 0 to F and X are allowed.

Remote command:

[TRIGger:A:CAN:IDENTifier](#) on page 612

[TRIGger:A:CAN:DATA](#) on page 613

Symbolic ID ← Identifier condition

If a label list with symbolic names was loaded and applied in the bus configuration, you can select a symbolic name from the list instead of entering the numeric identifier. The instrument triggers on the identifier of the selected node.

Data condition

The data condition consists of the following settings:

- Length of the data pattern
- Comparison
- Data pattern, see ["Bin / Hex pattern"](#) on page 272

Data ← Data condition

Defines the length of the data pattern - the number of bytes in the pattern.

Remote command:

[TRIGger:A:CAN:DLC](#) on page 612

Compare ← Data condition

Sets the data comparison condition. If the pattern contains at least one X (do not care), you can trigger on values equal or not equal to the specified value. If the pattern contains only 0 and 1, you can also trigger on a range greater than or lower than the specified value.

Remote command:

[TRIGger:A:CAN:DCondition](#) on page 612

12.5.4 CAN Decode Results

When the configuration of the serial bus is complete, the signal can be decoded:

1. In the "Bus" menu, enable "Decode".
2. In the "Display" menu, select the result display settings.
See [Chapter 12.1.2, "Displaying Decode Results"](#), on page 233.
3. In the "Bus Table" menu, enable the "Bus Table". Adjust the table settings.
See also: [Chapter 12.1.3, "Bus Table: Decode Results"](#), on page 234

The instrument captures and decodes the signal according to the protocol definition and the configuration settings.

The color-coding of the various protocol sections and errors simplifies the interpretation of the visual display. The decode information condenses or expands, depending on the horizontal scale. Various data formats are available to show the result values.

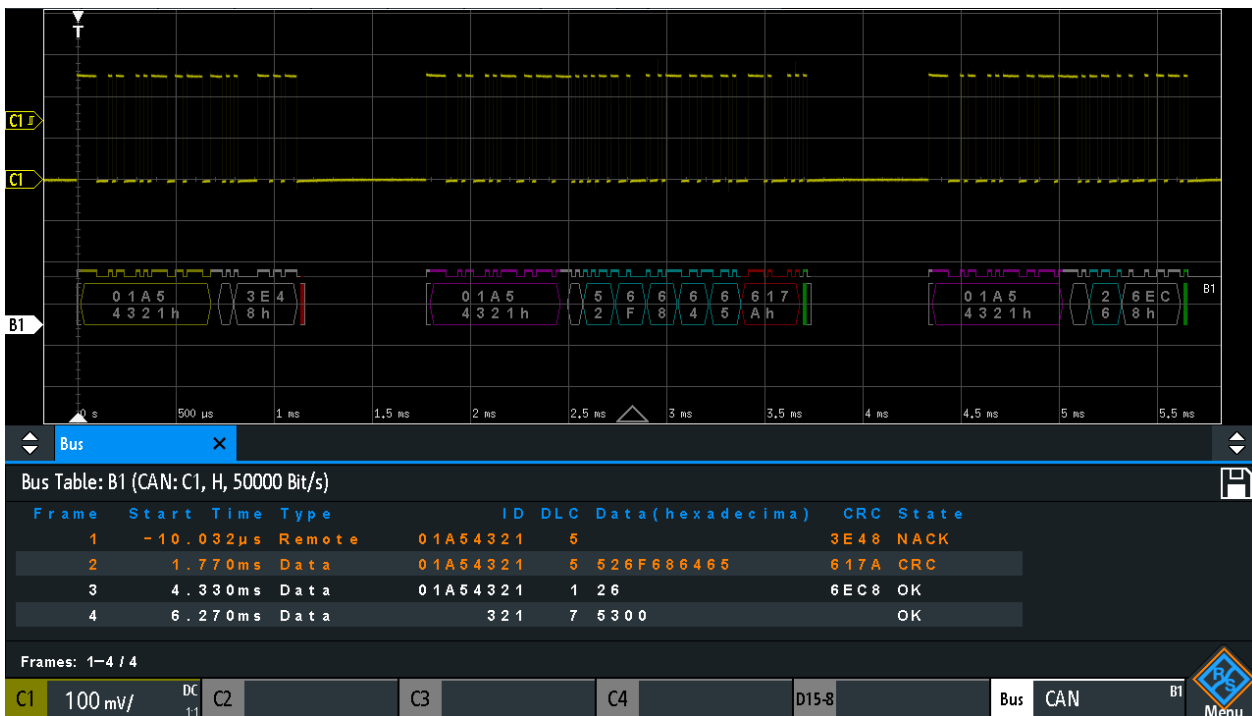

Figure 12-24: Decoded CAN signal with bus table, trigger on frame start

- violet = identifier
- gray = DLC, data length code
- blue = data words
- red = error occurred, error frame

The figure above shows a decoded CAN signal and the "Bus Table".

Table 12-4: Content of the CAN frame table

Column	Description
Time Diff.	Time of frame start in relation to the trigger point
Type	Frame type: Data, Remote, Error, or Overload
ID	Identifier value, hexadecimal value
DLC	Data length code, number of data bytes
Data	Hexadecimal values of the data bytes
CRC	Hexadecimal value of the Cyclic Redundance Check (checksum)
State	Overall state of the frame.

Remote commands are described in [Chapter 16.11.5.3, "CAN - Decode Results"](#), on page 614.

12.5.5 Search on Decoded CAN Data

Using the search functionality, you can find the same events in the decoded data which you also can trigger on. Unlike trigger, the search finds all events in an acquisition that fulfill the search condition. The results are listed in a table and can be saved to file.

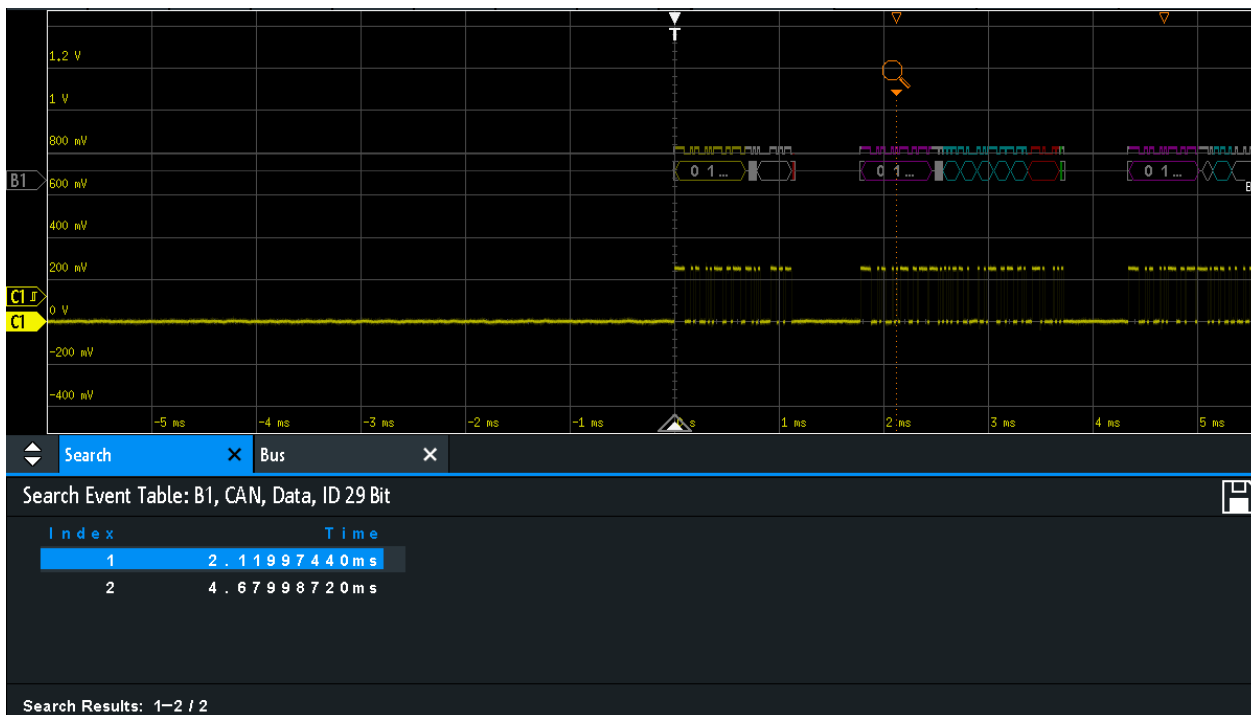

Figure 12-25: Search on a CAN bus for data frames with 29-bit ID

To search for events in a CAN signal

1. Configure and decode the bus correctly.
2. Acquire decoded data.
3. Press the Search key.
4. Select the "Search Type" = "Protocol".
5. Select the "Source": the bus that is configured for CAN protocol.
6. Select the "Event" you want to search for.
7. Enter additional settings, depending on the event.

CAN search settings

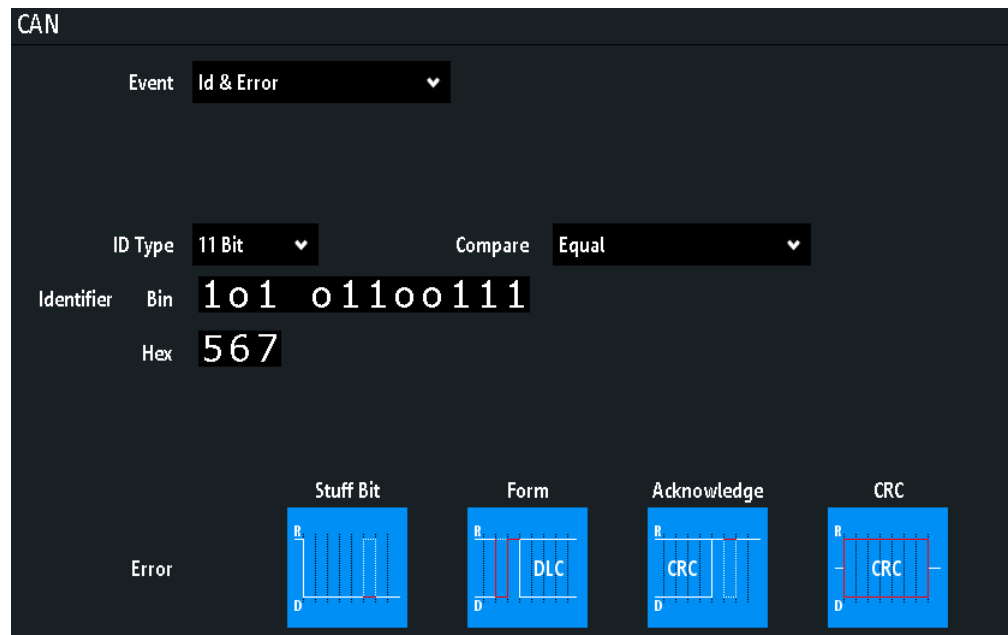

Figure 12-26: Settings for search on CAN bus for frames with identifier 567 (hex) that have an error

Event

Sets the event or combination of events to be searched for. For example, you can search for frames, errors, data, or IDs. Depending on the selected event, additional settings are displayed.

Remote command:

[SEARCH:PROTOCOL:CAN:CONDITION](#) on page 620

Frame Setup

Selects the frame type to be searched for.

If you search for remote or data frames, the search considers also the ID type, the length of the identifier. The setting is only available if "Event" = "Frame" is selected.

Remote command:

[SEARCH:PROTOCOL:CAN:FRAME](#) on page 621

Error

Selects the error type to be searched for. You can select one or more error types as search condition. The error types are the same as in the CAN trigger setup, see [Chapter 12.5.3, "CAN Trigger"](#), on page 268.

The setting is only available if "Event" = "Error" or "Error & ID" is selected.

Remote command:

[SEARCH:PROTOCOL:CAN:ACKERROR](#) on page 621

[SEARCH:PROTOCOL:CAN:BITSTERROR](#) on page 622

[SEARCH:PROTOCOL:CAN:CRCEERROR](#) on page 622

[SEARCH:PROTOCOL:CAN:FORMERROR](#) on page 622

Frame Type

Selects the frame type to be searched for, if "Event" = "Identifier" is selected. You can search for data and/or remote frames.

Remote command:

[SEARCH:PROTOCOL:CAN:FTYPE](#) on page 622

Identifier condition

Settings to define the identifier pattern, if "Event" = "Identifier" or "Id & Error" or "Id & Data" is selected.

After setting the "ID Type" and the "Compare" condition, you can enter the identifier value by setting the state high, low, or X (do not care) for each single bit. Alternatively, you can enter a hexadecimal value for each half byte. The settings are the same as for the setup of the identifier trigger, see also "[Identifier condition](#)" on page 271.

If a label list with node names was loaded and applied in the bus configuration, you can select the node name from the list instead of entering the numeric identifier. The instrument triggers on the identifier of the selected node.

Remote command:

[SEARCH:PROTOCOL:CAN:ITYPE](#) on page 622

[SEARCH:PROTOCOL:CAN:ICONDITION](#) on page 623

[SEARCH:PROTOCOL:CAN:IDENTIFIER](#) on page 623

Data condition

Settings to define the data pattern to be searched, if "Event" = "Id & Error" is selected.

After setting the "Data" length and the "Compare" condition, you can enter the data value by setting the state high, low, or X (do not care) for each single bit. Alternatively, you can enter a hexadecimal value for each half byte. The settings are the same as for the setup of the data trigger, see also "[Data condition](#)" on page 272.

Remote command:

[SEARCH:PROTOCOL:CAN:DLENGTH](#) on page 623

[SEARCH:PROTOCOL:CAN:DCONDITION](#) on page 623

[SEARCH:PROTOCOL:CAN:DATA](#) on page 624

12.5.6 CAN Label List

For general information on label lists and how to trigger on symbolic IDs, see [Chapter 12.1.5, "Label List"](#), on page 237.

Label list files are protocol-specific. A PTT label file for CAN protocols contains three values for each identifier:

- Identifier type, 11-bit or 29-bit long
- Identifier value
- Label, symbolic name of the identifier, specifying its function in the bus network.

Example: CAN PTT file

```
# -----
@FILE_VERSION = 1.00
```



```

@PROTOCOL_NAME = can
# -----
# Labels for CAN protocol
#   Column order: Identifier type, Identifier value, Label
# -----
11,064h,Diag_Response
11,1E5h,EngineData
11,0A2h,Ignition_Info
11,1BCh,TP_Console
11,333h,ABSdata
11,313h,Door_Left
11,314h,Door_Right
29,01A54321h,Throttle
29,13A00FA2h,LightState
29,0630ABCDh,Engine_Status
29,03B1C002h,Airbag_Status
29,01234ABCh,NM_Gateway
# -----

```

Label List: CAN (Imported on: 2017-03-30; 15:10)

Symbolic Label	ID / Addr
ABSdata	0x333
Airbag_Status	0x03B1 C002
Diag_Response	0x064
Door_Left	0x313
Door_Right	0x314
Engine_Status	0x0630 ABCD
EngineData	0x1E5
Ignition_Info	0x0A2
LightState	0x13A0 0FA2
NM_Gateway	0x0123 4ABC
Throttle	0x01A5 4321

Figure 12-27: Label list for CAN

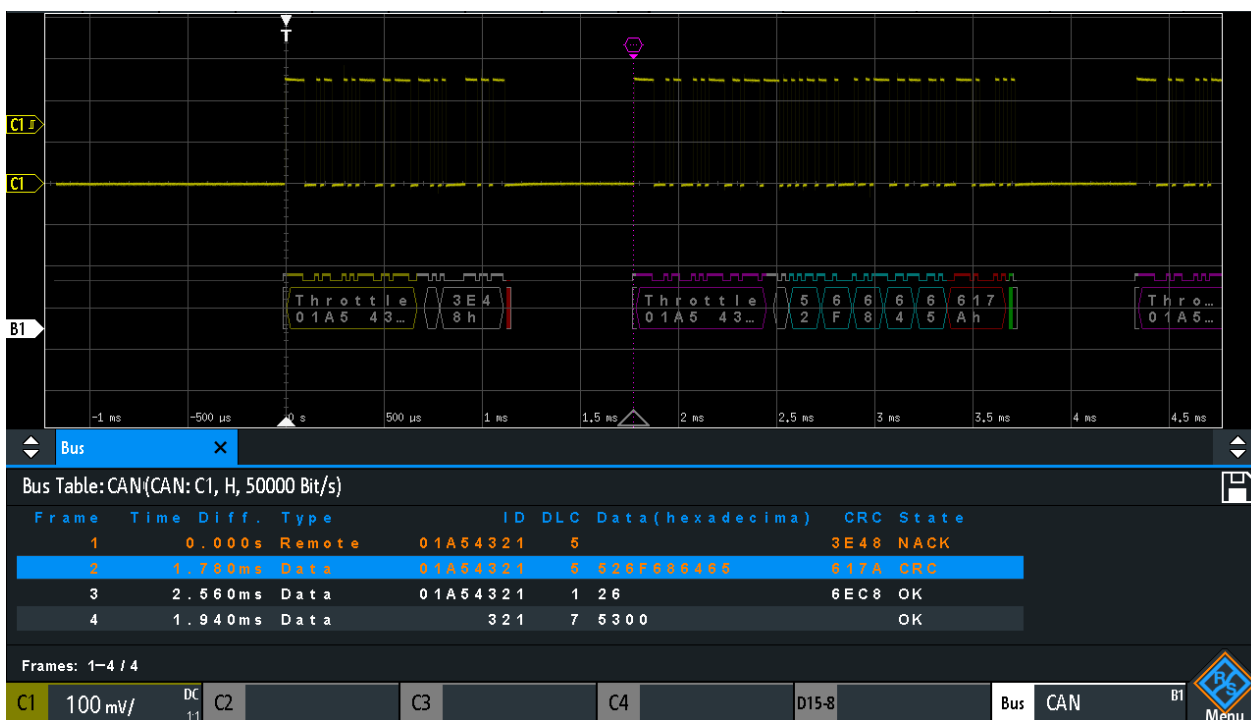

Figure 12-28: Decoded CAN signal with bus table and applied label list

12.6 LIN (Option R&S RTM-K3)

The Local Interconnect Network (LIN) is a simple, low-cost bus system used within automotive network architectures. LIN is usually a sub-network of a CAN bus. The primary purpose of LIN is the integration of uncritical sensors and actuators with low bandwidth requirements. Common applications in a motor vehicle are the control of doors, windows, wing mirrors, and wipers.

- [The LIN Protocol](#)..... 278
- [LIN Configuration](#)..... 280
- [LIN Trigger](#)..... 282
- [LIN Decode Results](#) 285
- [Search on Decoded LIN Data](#)..... 286
- [LIN Label List](#)..... 289

12.6.1 The LIN Protocol

This chapter provides an overview of protocol characteristics, frame format, identifiers and trigger possibilities. For detailed information, order the LIN specification on <http://www.lin-subbus.org/> (free of charge).

LIN characteristics

Main characteristics of LIN are:

- Single-wire serial communications protocol, based on the UART byte-word interface
- Single master, multiple slaves - usually up to 12 nodes
- Master-controlled communication: master coordinates communication with the LIN schedule and sends identifier to the slaves
- Synchronization mechanism for clock recovery by slave nodes without crystal or ceramics resonator

The R&S RTM3000 supports several versions of the LIN standard: v1.3, v2.0, v2.1 and the American SAE J2602.

Data transfer

Basic communication concept of LIN:

- Communication in an active LIN network is always initiated by the master.
- Master sends a message header including the synchronization break, the synchronization byte, and the message identifier.
- The identified node sends the message response: one to eight data bytes and one checksum byte.
- Header and response form the message frame.

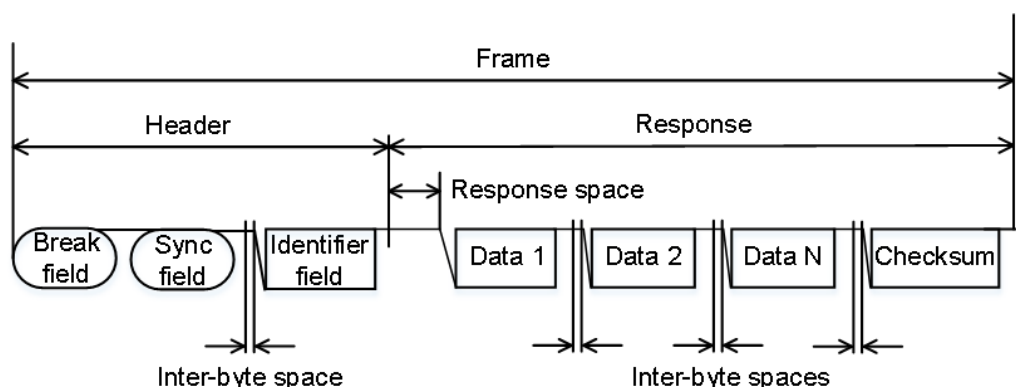

Figure 12-29: LIN frame with header and response

The data is transmitted in bytes using the UART byte-word interface without the parity bit. Each byte consists of a start bit, 8 bits and a stop bit.

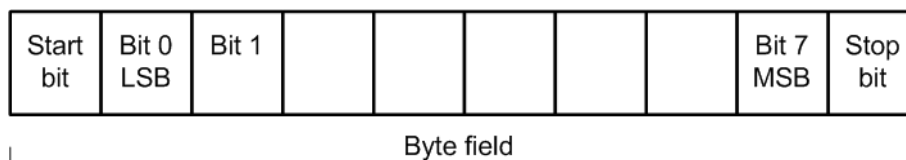

Figure 12-30: Structure of a byte field

Data bytes are transmitted LSB first.

The identifier byte consists of 6 bits for the frame identifier and two parity bits. This combination is known as protected identifier.

Trigger

The R&S RTM3000 can trigger on various parts of LIN frames. The data line must be connected to an input channel, triggering on math and reference waveforms is not possible.

You can trigger on:

- Frame start (synchronization field)
- Specific slave identifier or identifier range
- Data pattern in the message
- Wake up signal
- Checksum error (error in data), parity error (error in identifier)

12.6.2 LIN Configuration

The correct setup of the protocol parameters and the threshold is the condition for decoding the signal.

To set up and decode a LIN signal

1. Press the [Protocol] key in the Analysis area of the front panel.
2. Select the bus that you want to use: B1, B2, B3 or B4.
3. Select the "Bus Type" = LIN.
4. Select "Configuration".
5. Select the "Source", the channel to which the input signal is connected.
6. Set the threshold:
 - Tap "Find Threshold". The instrument evaluates the signal and sets the threshold.
 - Enter the threshold value in the numeric field.
7. Set the other signal parameters according to the signal characteristics. All settings are described below.
8. In the "Bus" menu, enable "Decode".

LIN Configuration Settings

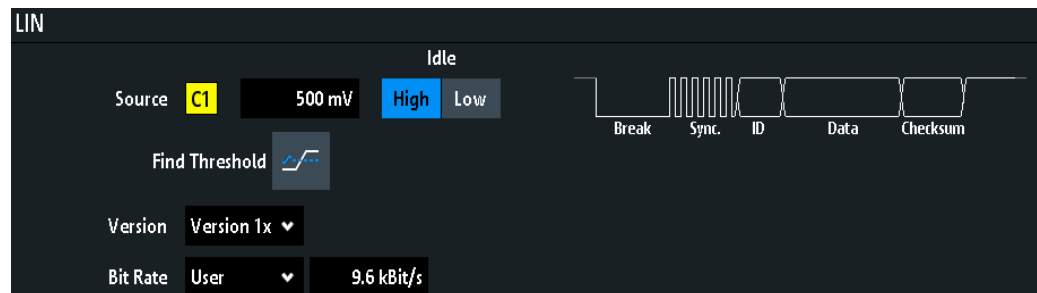

Figure 12-31: LIN setup dialog

Source.....	281
Idle.....	281
Threshold, Find Threshold.....	281
Version.....	281
Bit Rate.....	282

Source

Sets the source of the data line. All channel waveforms can be used.

If the MSO option R&S RTM-B1 is installed, you can use logic channels as source.

Remote command:

[BUS:LIN:DATA:SOURce](#) on page 624

Idle

Defines the idle state of the bus. The idle state is the recessive state and corresponds to a logic 1.

Remote command:

[BUS:LIN:POLarity](#) on page 625

Threshold, Find Threshold

Set the signal threshold for the source channel. Enter a value, or use "Find Threshold" to set the threshold to the middle reference level of the measured amplitude.

For analog channels, you can find the value also in the "Vertical" menu > "Channel <n>" > "Threshold"

For logic channels, you can find the value also in the "Logic" menu > "Technology".

Remote command:

[CHANnel<m>:THReshold](#) on page 421

[CHANnel<m>:THReshold:FINDlevel](#) on page 422

[DIGital<m>:THReshold](#) on page 739

Version

Selects the version of the LIN standard that is used in the DUT. The setting mainly defines the checksum version used during decoding.

The most common version is LIN 2.x. For mixed networks, or if the standard is unknown, set the LIN standard to "Any".

Remote command:

[BUS:LIN:STANdard](#) on page 625

Bit Rate

Sets the number of transmitted bits per second. The LIN standard defines a maximum bit rate of 20 kbit/s.

"Predefined" To select a bit rate from the list of predefined values, set "Bit Rate" to "Predefined" and select a value from the list.

"User" To set another value, set "Bit Rate" to "User" and enter a bit/s value.

Remote command:

[BUS:LIN:BITRate](#) on page 625

12.6.3 LIN Trigger

Before you set up the trigger, make sure that the bus is configured correctly. See [Chapter 12.6.2, "LIN Configuration"](#), on page 280.

To trigger on LIN signals:

1. Press the [Protocol] key in the Analysis area of the front panel.
2. Select the bus that is configured for LIN.
3. Select "Trigger".

This selection has several effects:

- Enables decoding, if necessary.
- Sets the "Trigger Type" to "Serial Bus" and the trigger source to the selected bus.
- Displays the "LIN Trigger" condition in the dialog box, below the protocol setup.

4. At "LIN Trigger", select the required trigger type:
 - "Start of Frame": stop bit of the sync field
 - "Wake Up": after a wakeup frame
 - "Error": checksum, parity or synchronization
 - "Identifier": specific message identifier or identifier range
 - "Identifier and Data": combination of identifier and data condition
5. If "Identifier" or "Identifier and Data" is selected, the LIN trigger setup dialog expands to define the serial pattern.

LIN Trigger Settings

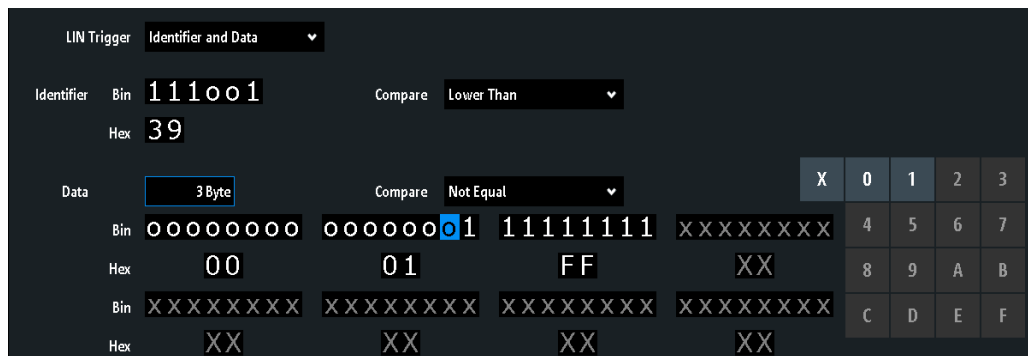

Figure 12-32: Trigger setup to trigger on identifier and data patterns

o (blue) = Selected bit in the 2nd byte of the data pattern, where the blue color indicates that the keypad is active for this bit

LIN Trigger..... 283

Error..... 284

 L Checksum..... 284

 L Parity..... 284

 L Synchronization..... 284

Identifier condition..... 284

 L Identifier..... 284

 L Compare..... 284

 L Symbolic ID..... 285

Data condition..... 285

 L Data..... 285

 L Compare..... 285

 L Bin / Hex..... 285

LIN Trigger

Selects the trigger mode.

- "Start of Frame" Triggers on the stop bit of the synchronization field.
- "Wake Up" Triggers after a wakeup frame.
- "Error" Identifies various errors in the frame. You can select one or more error types as trigger condition. See "Error" on page 284.
- "Identifier" Sets the trigger to a specific message identifier or an identifier range. Only the 6 bit identifier without parity bits is considered, not the protected identifier. See "Identifier condition" on page 284.
- "Identifier and Data" Triggers on a combination of identifier and data condition. The instrument triggers at the end of the last byte of the specified data pattern. An example is shown in Figure 12-32. See "Identifier condition" on page 284 and "Data condition" on page 285.

Remote command:

[TRIGger:A:LIN:TYPE](#) on page 626

Error

Select one or more error types as trigger condition.

Checksum ← Error

Checksum error. The checksum verifies the correct data transmission. It is the last byte of the frame response. The checksum includes not only the data but also the protected identifier (PID).

Remote command:

[TRIGger:A:LIN:CHKSError](#) on page 626

Parity ← Error

Parity error. Parity bits are the bits 6 and 7 of the identifier. They verify the correct transmission of the identifier.

Remote command:

[TRIGger:A:LIN:IPERror](#) on page 627

Synchronization ← Error

Error during synchronization.

Remote command:

[TRIGger:A:LIN:SYERror](#) on page 627

Identifier condition

The identifier condition consists of the following settings:

- Identifier value
- Comparison

Identifier ← Identifier condition

Defines the identifier pattern in binary and hexadecimal format. To set an individual binary bit or hex nibble (half byte), tap it and enter it via the on-screen keypad.

"Bin" String containing the binary pattern with a maximum of 64 bits. Characters 0, 1 and X are allowed.

"Hex" String containing the hexadecimal pattern with a maximum of 8 bytes. Characters 0 to F and X are allowed.

Remote command:

[TRIGger:A:LIN:IDENTifier](#) on page 627

Compare ← Identifier condition

Sets the identifier comparison condition: If the identifier pattern contains at least one X (don't care), you can trigger on values equal or not equal to the specified value. If the pattern contains only 0 and 1, you can also trigger on a range greater than or lower than the specified value.

Remote command:

[TRIGger:A:LIN:ICONdition](#) on page 627

Symbolic ID ← Identifier condition

If a label list with symbolic names was loaded and applied in the bus configuration, you can select a symbolic name from the list instead of entering the numeric identifier. The instrument triggers on the identifier of the selected node.

Data condition

The data condition consists of the following settings:

- Length of the data pattern
- Comparison
- Data pattern

Data ← Data condition

Defines the length of the data pattern - the number of bytes in the pattern.

Remote command:

[TRIGger:A:LIN:DLENgth](#) on page 628

Compare ← Data condition

Sets the comparison condition: If the pattern contains at least one X (don't care), you can trigger on values equal or not equal to the specified value. If the pattern contains only 0 and 1, you can also trigger on a range greater than or lower than the specified value.

Remote command:

[TRIGger:A:LIN:DCONdition](#) on page 628

Bin / Hex ← Data condition

Specifies the data pattern to be triggered. To set an individual binary bit or hexadecimal nibble (half byte), tap it and enter it via the on-screen keypad. Make sure to specify complete bytes.

"Bin" String containing the binary pattern with a maximum of 64 bits. Characters 0, 1 and X are allowed.

"Hex" String containing the hexadecimal pattern with a maximum of 8 bytes. Characters 0 to F and X are allowed.

Remote command:

[TRIGger:A:LIN:DATA](#) on page 627

12.6.4 LIN Decode Results

When the configuration of the serial bus is complete, the signal can be decoded:

1. In the "Bus" menu, enable "Decode".
2. In the "Display" menu, select the result display settings.
See [Chapter 12.1.2, "Displaying Decode Results"](#), on page 233.
3. In the "Bus Table" menu, enable the "Bus Table". Adjust the table settings.
See also: [Chapter 12.1.3, "Bus Table: Decode Results"](#), on page 234

The instrument captures and decodes the signal according to the protocol definition and the configuration settings.

The color-coding of the various protocol sections and errors simplifies the interpretation of the visual display. The decode information condenses or expands, depending on the horizontal scale. Various data formats are available to show the result values.

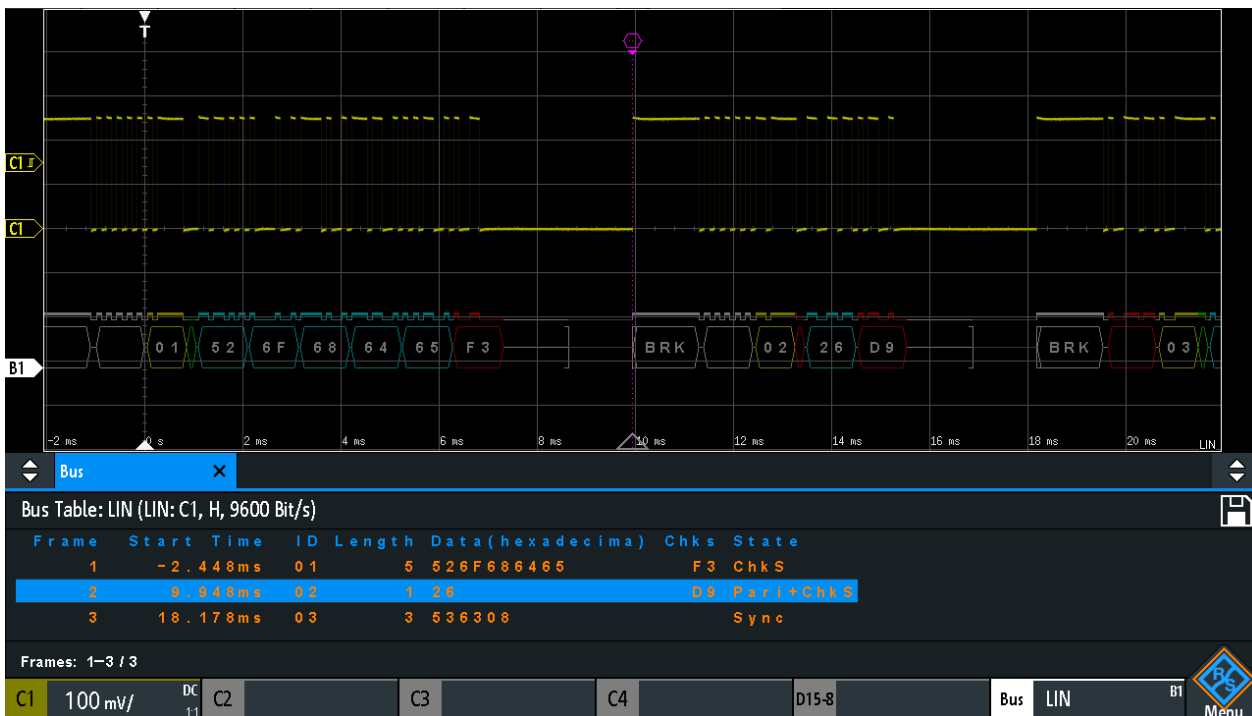

Figure 12-33: Decoded LIN signal with bus table, trigger on frame start

Table 12-5: Content of the LIN frame table

Column	Description
Start time	Time of frame start in relation to the trigger point
ID	Identifier value, hexadecimal value
Length	Number of data bytes
Data	Hexadecimal values of the data bytes
Chks	Checksum value
State	Overall state of the frame.

Remote commands are described in [Chapter 16.11.6.3, "LIN - Decode Results"](#), on page 628.

12.6.5 Search on Decoded LIN Data

Using the search functionality, you can find the same events in the decoded data which you also can trigger on. Unlike trigger, the search finds all events in an acquisition that fulfill the search condition. The results are listed in a table and can be saved to file.

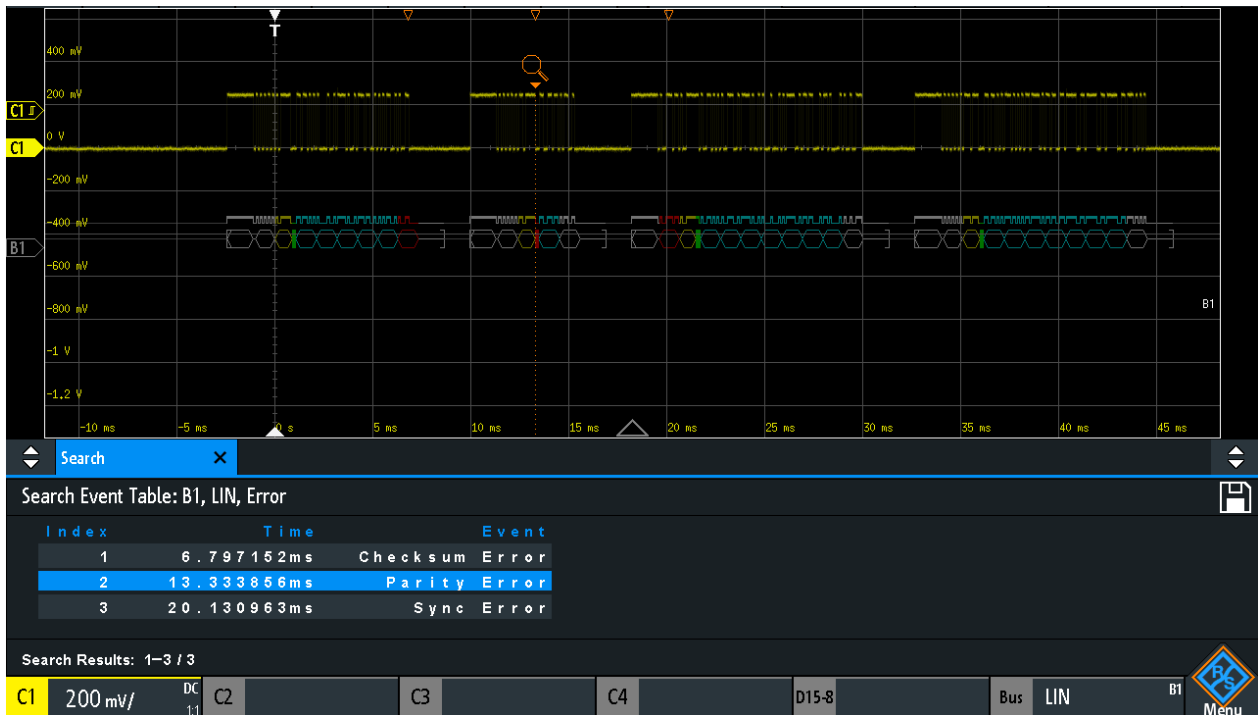

Figure 12-34: Search on a LIN bus for errors

To search for events in a LIN signal

1. Configure and decode the bus correctly.
2. Acquire decoded data.
3. Press the Search key.
4. Select the "Search Type" = "Protocol".
5. Select the "Source": the bus that is configured for LIN protocol.
6. Select the "Event" you want to search for.
7. Enter additional settings, depending on the event.

LIN Search Settings

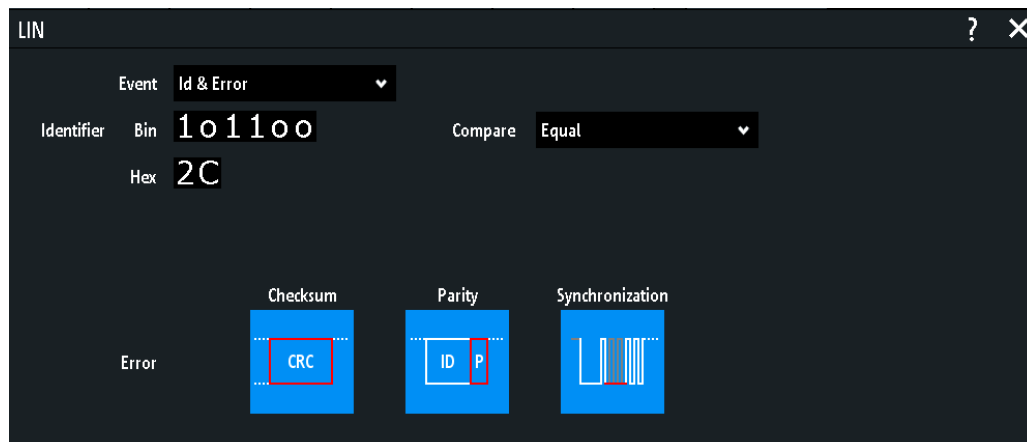

Figure 12-35: Search on LIN bus for frames with identifier 2C (hex) that have an error

Event.....	288
Frame Setup.....	288
Error.....	288
Identifier condition.....	288
Data condition.....	289

Event

Sets the event or combination of events to be searched for. Depending on the selected event, additional settings are displayed.

Remote command:

[SEARCH:PROTOCOL:LIN:CONDition](#) on page 634

Frame Setup

Selects the frame type to be searched for.

Remote command:

[SEARCH:PROTOCOL:CAN:FRAME](#) on page 621

Error

Selects the error type to be searched for. You can select one or more error types as search condition. The error types are the same as in the LIN trigger setup.

See also "Error" on page 284.

The setting is only available if "Event" = "Error" or "ID & Error" is selected.

Remote command:

[SEARCH:PROTOCOL:LIN:CHKSError](#) on page 635

[SEARCH:PROTOCOL:LIN:IPERror](#) on page 635

[SEARCH:PROTOCOL:LIN:SYERror](#) on page 635

Identifier condition

Settings to define the identifier pattern, if "Event" = "Identifier" or "Id & Error" or "Id & Data" is selected.

After setting the "Compare" condition, you can enter the identifier value by setting the state high, low, or X (do not care) for each single bit. Alternatively, you can enter a hexadecimal value for each half byte.

The settings are the same as for the setup of the identifier trigger, see also "[Identifier condition](#)" on page 284.

If a label list with node names was loaded and applied in the bus configuration, you can select the node name from the list instead of entering the numeric identifier. The instrument triggers on the identifier of the selected node.

Remote command:

`SEARCH:PROTOCOL:LIN:ICONdition` on page 635

`SEARCH:PROTOCOL:LIN:IDENTifier` on page 636

Data condition

Settings to define the data pattern to be searched, if "Event" = "Id & Error" is selected.

After setting the "Data" length and the "Compare" condition, you can enter the data value by setting the state high, low, or X (do not care) for each single bit. Alternatively, you can enter a hexadecimal value for each half byte.

The settings are the same as for the setup of the data trigger, see also "[Data condition](#)" on page 285.

Remote command:

`SEARCH:PROTOCOL:LIN:DLENGTH` on page 636

`SEARCH:PROTOCOL:LIN:DCONDITION` on page 636

`SEARCH:PROTOCOL:LIN:DATA` on page 636

12.6.6 LIN Label List

For general information on label lists, see [Chapter 12.1.5, "Label List"](#), on page 237.

Label lists are protocol-specific. Label lists for LIN are available in CSV and PTT format.

A LIN label file contains two values for each identifier:

- Identifier value
- Symbolic name for the identifier

Example of a LIN PTT file

```
# -----
@FILE_VERSION = 1.0
@PROTOCOL_NAME = lin
# -----
# Labels for LIN protocol
#   Column order: Identifier, Label
# -----
# Labels for standard addresses
0x3F, Temperature
1Ch, Left brake
20h, Right brake
```

```
# Following ID is provided as integer
33,Mirror
0x37,Indoor lights
# Labels for reserved addresses
0x3C,Master_Request_Frame
0x3D,Slave_Response_Frame
# -----
```

Label List: LIN (Imported on: 2017-03-30; 16:50)

Symbolic Label	ID / Addr
Dashboard	0x03
Door controller	0x2E
Gateway	0x02
Indoor lights	0x37
Master_Request_Frame	0x3C
Mirror	0x01
Reserved_Frame	0x3F
Slave_Response_Frame	0x3D
Temperature	0x04
User_Defined_Frame	0x3E

Figure 12-36: Label list for LIN

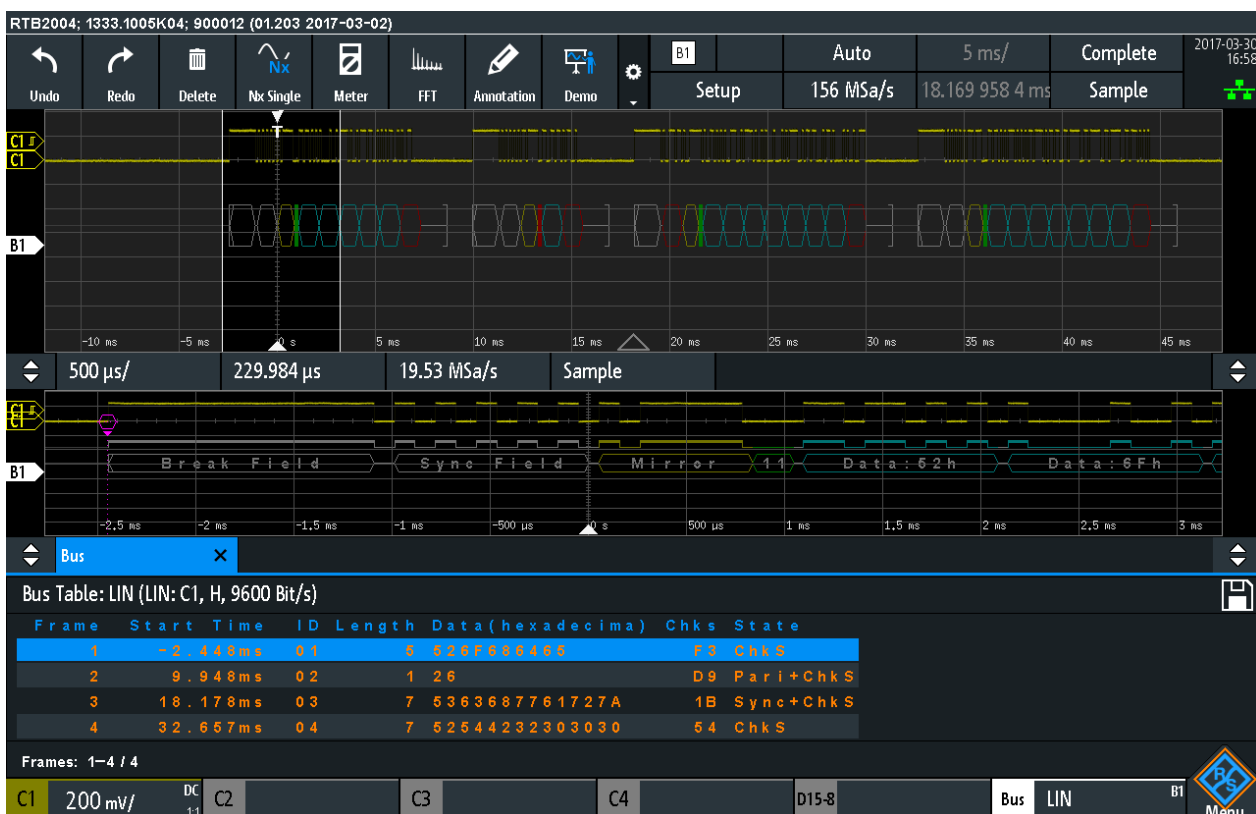

Figure 12-37: Decoded LIN signal with frame table and applied label list

gray = synchronization break, synchronization byte, correct checksum
 yellow = identifier
 green = parity bits
 blue = data words (UART words)

12.7 Audio Signals (Option R&S RTM-K5)

The R&S RTM3000 can analyze several standard and de-facto industry standard signals: I²S Inter-IC Sound standard audio format, left justified and right justified data formats and Time Division Multiplexed (TDM) audio format.

12.7.1 Audio Protocols

All audio protocols use 3 lines:

- The clock line generates the bit clock.
- The word select line (WS, also known as word clock) defines the frame start and the maximum length of the data word.
 For pulse code modulated signals (I²S standard, left and right justified data formats), the level of the WS signal assigns the data words to the left and right channels.

TDM uses frame synchronization pulses on the WS line to identify the beginning of a frame.

- The data line transmits the audio data in time-multiplexed data channels.

12.7.1.1 I²S Standard

I²S standard interfaces transmit two PCM coded audio channels. The WS line selects the channel being transmitted - left or right channel. Usually, 32 bits are transmitted on each channel. The data word can be shorter than the channel length, and the receiver ignores the remaining bits. The first byte of the audio word is delayed one clock period from the leading edge of the word select pulse. The R&S RTM3000 can decode I²S standard signals with MSBF and LSBF bit order.

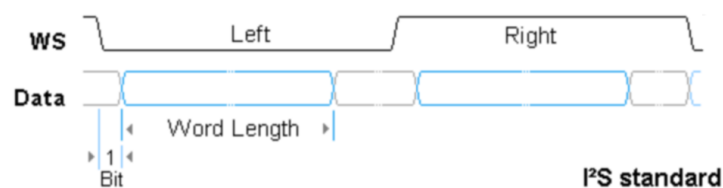

12.7.1.2 Left Justified Data Format

The left justified data format is very similar to the I²S standard, but the first byte of the audio word is aligned with the leading edge of the word select pulse. Thus the audio word is left justified within the frame. The data word can be shorter than the channel length.

In addition to the standard configuration, the R&S RTM3000 can analyze also left justified data formats which send the data word with offset to the WS edge. The bit order can be MSBF or LSBF.

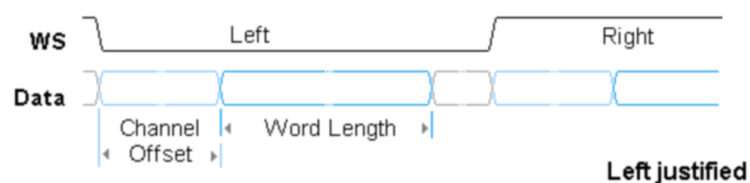

12.7.1.3 Right Justified Data Format

The right-justified data format is similar to the left-justified, but the last byte of the word in the frame is aligned with the trailing edge of the word select pulse. Thus the audio word is right-aligned within the frame.

12.7.1.4 TDM

The Time Division Multiplexed (TDM) audio format is not standardized and provides high flexibility for transfer of more than two audio data channels on one line. On the word select line, it uses frame synchronization pulses to identify the beginning of a

frame. On the data line, channel blocks of a defined length are transmitted. Each block contains an audio word that can be shorter than the channel length.

Channel length, channel offset and word length are dependent values:

$$\text{Channel length} \geq \text{Word length} + \text{Channel offset}$$

12.7.2 Audio Configuration

The correct setup of the protocol parameters and the threshold is the condition for decoding the signal.

To set up and decode an audio signal

1. Press the [Protocol] key in the Analysis area of the front panel.
2. Select the bus that you want to use: B1, B2, B3 or B4.
3. Select the "Bus Type" = Audio.
4. Select "Configuration".
5. Select the "Word Select", "Clock" and "Data" channel sources.
6. Set the threshold. Use one of these methods:
 - Tap "Find Threshold". The instrument evaluates the signal and sets the threshold.
 - Enter the threshold value in the numeric field.
7. Set the other signal parameters according to the signal characteristics. All settings are described below.
8. In the "Bus" menu, enable "Decode".

Audio configuration settings

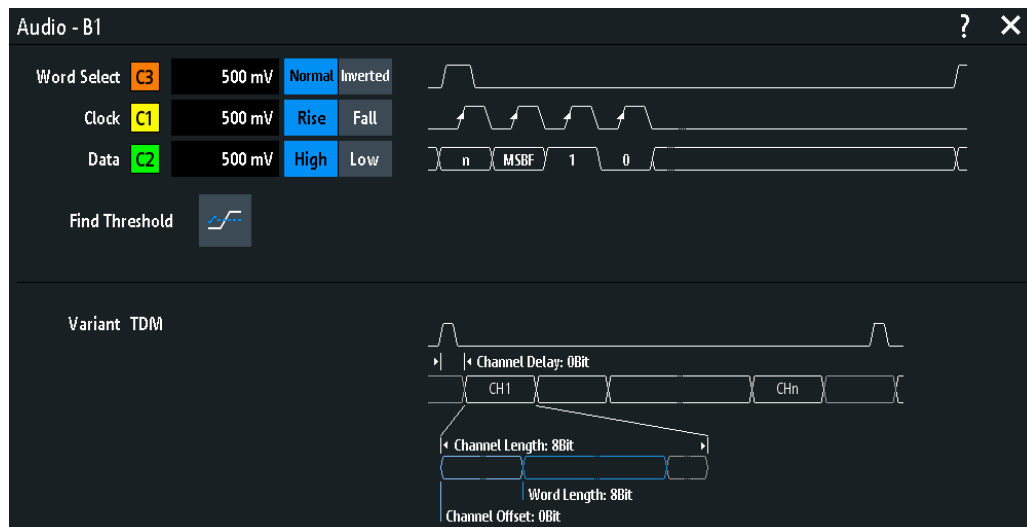

Figure 12-38: Audio setup dialog

Source

Selects the audio line that you want to configure in the menu.

Word Select

Selects the source of the word select line.

If the MSO option R&S RTM-B1 is installed, you can use logic channels as source.

Remote command:

[BUS:I2S:WSElect:SOURce](#) on page 642

Polarity

For I²S, LJ and RJ signals, the polarity defines the word select values assigned to the left and right channels.

- "Normal": 0 indicates the left channel, and 1 indicates the right channel. This is the usual setting.
- "Inverted": 0 indicates the right channel, and 1 the left channel.

For TDM signals, the polarity defines the edge of the frame synchronization pulse that identifies the beginning of a frame. The frame starts at the next clock edge following the selected FSYNC edge.

- "Normal": the frame begins with a rising edge. This is the usual setting.
- "Inverted": the frame begins with a falling edge.

Remote command:

[BUS:I2S:WSElect:POLarity](#) on page 641

Threshold, Find Threshold

Set the signal threshold for the source channel. Enter a value, or use "Find Threshold" to set the threshold to the middle reference level of the measured amplitude.

For analog channels, you can find the value also in the "Vertical" menu > "Channel <n>" > "Threshold"

For logic channels, you can find the value also in the "Logic" menu > "Technology".

Remote command:

[CHANnel<m>:THReshold](#) on page 421

[CHANnel<m>:THReshold:FINDlevel](#) on page 422

[DIGital<m>:THReshold](#) on page 739

Clock

Selects the source of the clock line.

If the MSO option R&S RTM-B1 is installed, you can use logic channels as source.

Remote command:

[BUS:I2S:CLOCK:SOURce](#) on page 639

Slope

Sets the clock edge at which the instrument samples the data on the data line. Usually, the rising edge is used. The R&S RTM3000 can also analyze the converse setup.

Remote command:

[BUS:I2S:CLOCK:POLarity](#) on page 639

Data

Selects the source of the data line.

If the MSO option R&S RTM-B1 is installed, you can use logic channels as source.

Remote command:

[BUS:I2S:DATA:SOURce](#) on page 640

Active

Defines the interpretation of high and low signal states.

- "Active high": HIGH (signal level above the threshold level) = 1 and LOW (signal level below the threshold level) = 0
- "Active low": HIGH = 0 and LOW = 1

Remote command:

[BUS:I2S:DATA:POLarity](#) on page 639

Variant

Selects the protocol variant of the audio signal. The configuration possibilities in R&S RTM3000 exceed the definitions of the standards.

- | | |
|-------------------|--|
| "I2S Standard" | Inter-IC Sound standard audio format. The first byte of the audio word is delayed one clock period from the leading edge of the word select pulse. |
| "Left justified" | The left justified data format is similar to the I ² S standard. The first byte of the audio word is aligned with the leading edge of the word select pulse. Thus the audio word is left justified within the frame. In R&S RTM3000, an additional offset of the audio word can be set. |
| "Right justified" | In right justified data, the last byte of the word in the frame is aligned with the trailing edge of the word select pulse. Thus the audio word is right-aligned within the frame. In R&S RTM3000, an additional offset of the audio word can be set. |

"TDM" The Time Division Multiplexed audio format can transfer of up to 8 audio data channels on one line. On the word select line, it uses frame synchronization pulses to identify the beginning of a frame. On the data line, channel blocks of a defined length are transmitted. Each block contains an audio word.

Remote command:

`BUS:I2S:AVARiant` on page 637

12.7.3 Setup of Audio Variants

Depending on the selected audio variant, different settings are available.



Figure 12-39: Setup menu Audio Left Justified Variant

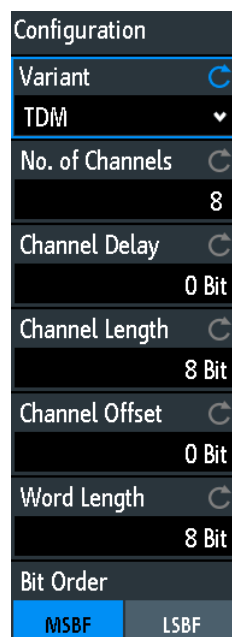

Figure 12-40: Setup menu Audio TDM Variant

First Channel

Defines if the left or the right channel is the first channel in the frame.

The setting is available for I²S standard, left and right justified audio signals.

Remote command:

`BUS:I2S:CHANnel:ORDer` on page 638

No. of Channels

Sets the number of channels transmitted on the TDM audio line.

Remote command:

`BUS:I2S:CHANnel:TDMCount` on page 638

Channel Delay

Sets a delay of the channel blocks after the frame start (word select edge). Thus, all channels are shifted.

The setting is available only for TDM signals.

Remote command:

`BUS:I2S:FOFFset` on page 641

Channel Length

Sets the number of bits in a channel block for TDM audio signals (transmitter length).

The setting is available only for TDM signals.

Remote command:

`BUS:I2S:CHANnel:LENGth` on page 638

Channel Offset

Sets the number of bits between the channel start and the start of the audio word. The setting is available for left justified data format and TDM audio signals.

For TDM, possible values depend on the channel length and the word length. The maximum offset is *Channel length - Word length*. If you change the channel length or the word length, the channel offset is adjusted automatically.

Remote command:

`BUS:I2S:CHANnel:OFFSet` on page 638

Word Length

Defines the number of bits in an audio data word (receiver length). The minimum length is 1 bit, the maximum length is the channel length.

Remote command:

`BUS:I2S:WLENgth` on page 641

Bit Order

Sets the bit order in the audio data words. Usually, the MSB is transmitted first.

Remote command:

`BUS:I2S:BORDer` on page 637

12.7.4 Audio Trigger

Before you set up the trigger, make sure that the bus is configured correctly. See [Chapter 12.7.2, "Audio Configuration"](#), on page 293.

To trigger on Audio signals:

1. Press the [Protocol] key in the Analysis area of the front panel.
2. Select the bus that is configured for Audio.
3. Select "Trigger".

This selection has several effects:

- Enables decoding, if necessary.
- Sets the "Trigger Type" to "Serial Bus" and the trigger source to the selected bus.
- Displays the trigger conditions in the dialog box, below the protocol setup.

4. At "Audio Trigger", select the required trigger type:
 - "Data"
 - "Window"
 - "Word Select"
 - "Error"
5. Set the other trigger parameters according to the signal characteristics. The available settings depend on the selected trigger type. All settings are described below.

Audio trigger settings

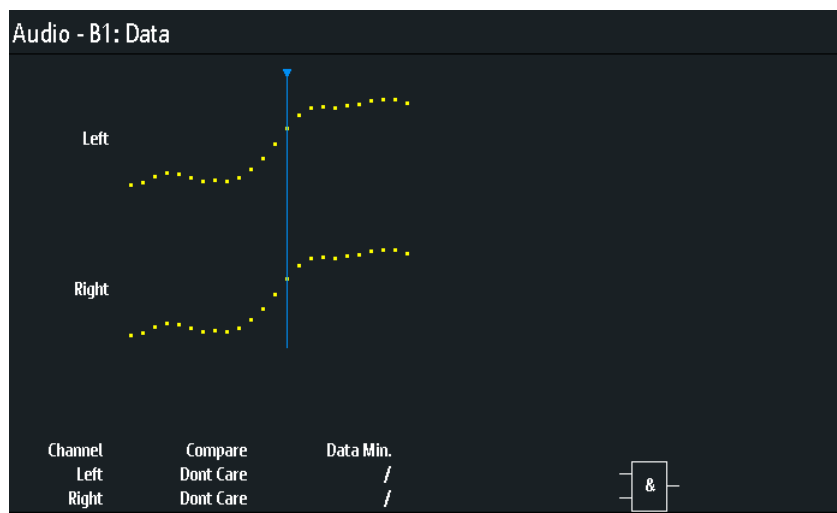

Channel

Selects the audio channel on which the instrument looks for the specified data condition. The setting is relevant for trigger types data and window.

Compare

Defines the operator for comparison of the decoded data word with the specified data word.

The following operators can be set: equal, not equal, greater than, lower than, in range and out of range.

If the data on the selected channel is not relevant for the trigger condition, select "Don't care".

The setting is relevant for data and window trigger types.

Remote command:

[TRIGger:A:I2S:CHANnel:LEFT:CONDition](#) on page 643

[TRIGger:A:I2S:CHANnel:RIGHT:CONDition](#) on page 644

[TRIGger:A:I2S:CHANnel:TDM<n>:CONDition](#) on page 644

Data / Data Min. / Data Max.

Define the data words to be compared with the decoded data word. The data format is decimal. The maximum value is limited by the word length. Consider that audio words are signed numbers in 2's complement format. For example, an 8-bit data word has a value range from -128 to 127.

The setting is relevant for trigger types data and window.

Remote command:

[TRIGger:A:I2S:CHANnel:LEFT:DMAX](#) on page 643

[TRIGger:A:I2S:CHANnel:LEFT:DMIN](#) on page 643

[TRIGger:A:I2S:CHANnel:RIGHT:DMAX](#) on page 644

[TRIGger:A:I2S:CHANnel:RIGHT:DMIN](#) on page 644

[TRIGger:A:I2S:CHANnel:TDM<n>:DMAX](#) on page 645

[TRIGger:A:I2S:CHANnel:TDM<n>:DMIN](#) on page 645

Combination

Sets the logical combination to trigger on data words on different channels. The instrument triggers if all conditions are met inside one frame.

"And": the instrument triggers if the data conditions on all selected channels are fulfilled.

"Or": The instrument triggers if one of the specified data conditions is fulfilled.

The setting is relevant for trigger types data and window.

Remote command:

[TRIGger:A:I2S:FUNCTion](#) on page 645

Window Length

Sets the number of subsequent frames (audio samples) for which the data conditions are fulfilled.

Remote command:

[TRIGger:A:I2S:WINDow:LENGth](#) on page 646

Word Select

Sets the rising ("Positive") or falling ("Negative") edge of the word select signal as trigger condition.

Consider your "Word Select" > "Polarity" setting in the audio configuration menu.

Remote command:

[TRIGger:A:I2S:WSSlope](#) on page 646

12.7.5 Audio Decode Results

When the configuration of the serial bus is complete, the signal can be decoded:

1. In the "Bus" menu, enable "Decode".
2. In the "Display" menu, select the result display settings.
See [Chapter 12.1.2, "Displaying Decode Results"](#), on page 233.
3. In the "Bus Table" menu, enable the "Bus Table". Adjust the table settings.
See also: [Chapter 12.1.3, "Bus Table: Decode Results"](#), on page 234

The instrument captures and decodes the signal according to the protocol definition and the configuration settings.

The color-coding of the various protocol sections and errors simplifies the interpretation of the visual display. The decode information condenses or expands, depending on the horizontal scale. Various data formats are available to show the result values.

The figure above shows a decoded Audio signal and the "Bus Table".

Table 12-6: Content of the audio frame table

Column	Description
Frame	Frame number
Start time	Time of frame start in relation to the trigger point
Time Diff.	Time difference of the frame in relation to the previous frame
Left, Right (I ² S, LJ, RJ) CH1, CH2,...CH8 (TDM)	Hexadecimal values of the audio words

Remote commands are described in [Chapter 16.11.7.3, "Audio Decode Results"](#), on page 646.

12.8 MIL-STD-1553 (Option R&S RTM-K6)

- [The MIL-STD-1553](#) 301
- [MIL-STD-1553 Configuration](#)..... 303
- [MIL-STD-1553 Trigger](#)..... 305
- [MIL-STD-1553 Decode Results](#)..... 310
- [MIL-STD-1553 Label List](#)..... 311

12.8.1 The MIL-STD-1553

The MIL-STD-1553 specification defines the characteristics of a serial data bus originally designed for use in the military avionics. Nowadays it is also used in spacecraft on-board data handling.

The bus is a 2-wire bus that uses differential signals.

A MIL-STD-1553 system consists of the following components:

- Bus Controller (BC): initiates and coordinates the data flow in the system.
- Remote Terminal (RT): interfaces various subsystems with the data bus. A system consists of up to 31 RTs and each RT can have 31 subaddresses. The subaddresses 0 and 31 refer to a mode code command.
- Bus Monitor (BM) (optional): listens to all messages and can record selected data for real-time or off-line analysis.

The information is transmitted over the bus in defined series of words using Manchester code, where each bit is transmitted as high-low for a logical 1 or a low-high for a logical 0. There are three types of words: command, data and status.

Command Word

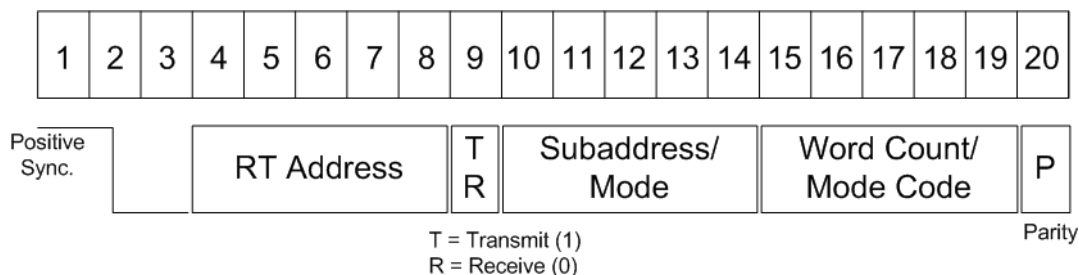
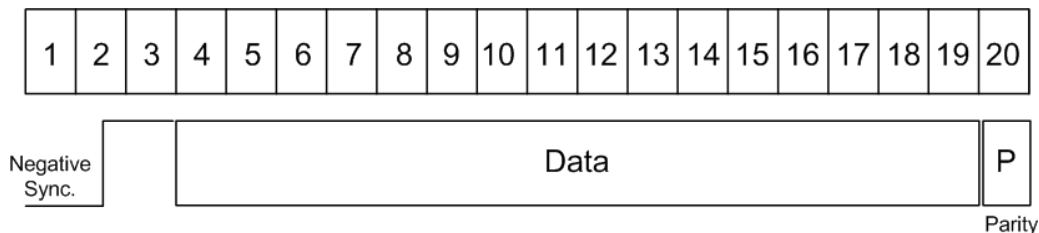

Figure 12-41: Structure of a command word

The format of a command word consists of the following parts (see [Figure 12-41](#)):

- Sync: an invalid Manchester waveform.
- Remote Terminal (RT) Address: the unique address of the corresponding RT.
- Transmit/Receive (T/R): indicates the action required from the RT.
- Subaddress/Mode Code: indicates the RT subaddress. The subaddresses 0 and 31 signalize the transmission of a mode code.
- Data Word Count /Mode Code: indicates the number of words that are sent/received by the RT. A maximum of 32 words is allowed. This field may be used for the transmission of the mode code value.
- Parity: checks if there are bit errors during the transmission. The total number of logic 1 bits for the word (sync bits not included) shall be odd.

Data Word**Figure 12-42: Structure of a data word**

The format of a data word consists of the following parts (see [Figure 12-42](#)):

- Sync: an invalid Manchester waveform.
- Data: the transferred information (16 bit).
- Parity: checks if there are bit errors during the transmission. The total number of logic 1 bits for the word (sync bits not included) shall be odd.

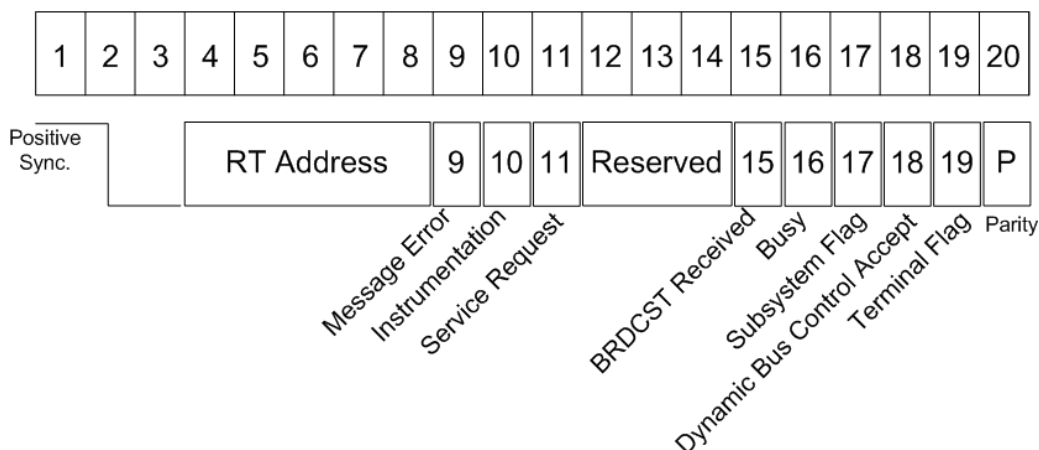
Status Word**Figure 12-43: Structure of a status word**

The format of a status word consists of the following parts (see [Figure 12-43](#)):

- Sync: an invalid Manchester waveform.
- Remote Terminal (RT) Address: the unique address of the corresponding RT.
- Message error: indicates an error in the command/data word transmission from the BC. A logic 1 indicates presence of a message error and a logic 0 indicates its absence.
- Instrumentation: helps to distinguish between a status word and a command word. The logic state of this bit shall be 0.
- Service Request: indicates that the RT requires service. A logic 1 indicates a presence of a service request and logic 0 indicates its absence.
- Reserved: bits reserved for future uses.
- Broadcast Command: a logic 1 indicates that the preceding valid command word was a broadcast command and a logic 0 that it was not.

- **Busy:** a busy state indicates that the RT or the subsystem is not able to transfer data. A logic 1 indicates a presence of a busy condition and logic 0 indicates its absence.
- **Subsystem Flag:** flags a subsystem fault. A logic 1 indicates a presence of a flag and logic 0 indicates its absence.
- **Dynamic Bus Control Acceptance:** a logic 1 indicates acceptance of a dynamic bus control and a logic 0 a rejection.
- **Terminal Flag:** flags an RT fault condition. A logic 1 indicates a presence of a flag and logic 0 indicates its absence.
- **Parity:** checks if there are bit errors during the transmission. The total number of logic 1 bits for the word (sync bits not included) shall be odd.

For comfortable analysis, you can load an editable label list, to interpret transferred numeric values as meaningful text labels.

12.8.2 MIL-STD-1553 Configuration

The correct setup of the protocol parameters and the threshold is the condition for decoding the signal.

To set up and decode an MIL-STD-1553 signal

1. Press the [Protocol] key in the Analysis area of the front panel.
2. Select the bus that you want to use: B1, B2, B3 or B4.
3. Select the "Bus Type" = MIL-STD-1553.
4. Select "Configuration".
5. Select the "Source", the channel to which the input signal is connected.
6. Set the "Threshold High" and "Threshold Low".
7. Set the other signal parameters according to the signal characteristics. All settings are described below.
8. In the "Bus" menu, enable "Decode".

MIL-STD-1553 Configuration Settings

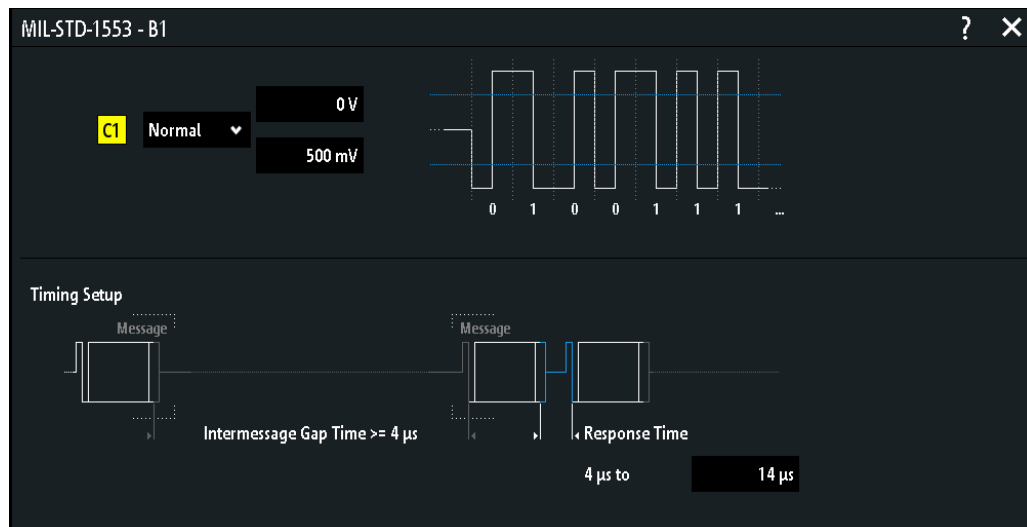

Figure 12-44: MIL-STD-1553 setup dialog

Configuration

Opens a dialog box to configure the MIL signal.

Source

Sets the channel for the signal source.

Remote command:

[BUS:MILStd:SOURce](#) on page 651

Polarity

Sets the polarity of the bus.

Remote command:

[BUS:MILStd:POLarity](#) on page 650

Threshold, Find Threshold

Set the signal threshold for the source channel. Enter a value, or use "Find Threshold" to set the threshold to the middle reference level of the measured amplitude.

For analog channels, you can find the value also in the "Vertical" menu > "Channel <n>" > "Threshold"

For logic channels, you can find the value also in the "Logic" menu > "Technology".

Remote command:

[CHANnel<m>:THReshold](#) on page 421

[CHANnel<m>:THReshold:FINDlevel](#) on page 422

[DIGital<m>:THReshold](#) on page 739

Threshold High

Sets the high threshold level.

Remote command:

`BUS:MILStd:THReshold:HIGH` on page 651

Threshold Low

Sets the low threshold level.

Remote command:

`BUS:MILStd:THReshold:LOW` on page 651

Response Max

Sets the range for the response time.

Remote command:

`BUS:MILStd:RESPonsetime:INFinite` on page 650

`BUS:MILStd:RESPonsetime:MAXimum` on page 651

`BUS:MILStd:RESPonsetime:MINimum` on page 651

IMG Time

Sets the range of the inter message gap time.

Remote command:

`BUS:MILStd:IMGTime:INFinite` on page 650

`BUS:MILStd:IMGTime:MAXimum` on page 650

`BUS:MILStd:IMGTime:MINimum` on page 650

12.8.3 MIL-STD-1553 Trigger

Before you set up the trigger, make sure that the bus is configured correctly. See [Chapter 12.8.2, "MIL-STD-1553 Configuration"](#), on page 303.

To trigger on MIL-STD-1553 signals:

1. Press the [Protocol] key in the Analysis area of the front panel.
2. Select the bus that is configured for LIN.
3. Select "Trigger".

This selection has several effects:

 - Enables decoding, if necessary.
 - Sets the "Trigger Type" to "Serial Bus" and the trigger source to the selected bus.
 - Displays the "MIL Trigger" condition in the dialog box, below the protocol setup.
4. At "MIL Trigger", select the required trigger type:
 - "Error": combination of protocol errors
 - "Command": on a defined command
 - "Status": on a defined status
 - "Cmd. and data": on a defined command and data
5. Set the other trigger parameters according to the signal characteristics. All settings are described below.

MIL-STD-1553 Trigger Settings

MIL-STD-1553 - B1

Trigger On : Command

Bit Times 1 2 3 4 5 6 7 8 9 10 11 12 13 14 15 16 17 18 19 20

Command RT Address D Sub Address Word Count P

Symbolic ID : User defined

RT Address : Equal 0xFF xxxxx

Data Direction : Either

Sub Address : Equal 0xFF xxxxx

Word Count : Greater Equal 0

Figure 12-45: Trigger setup to trigger on identifier and data patterns

Synchronization

Triggers on a sync impulse. You can select to trigger on "C/S" (Commando/Status), on "Data" or on "All" sync pulses.

Remote command:

[TRIGger:A:MILStd:SYNC](#) on page 658

Word

Selects the word type to be triggered on. The selected word type is indicated in the softkey name.

Remote command:

[TRIGger:A:MILStd:WORD](#) on page 659

Error

Triggers on any combination of protocol errors. You can enable triggering on a specific type of error in the submenu.

Synchronization ← Error

Triggers if a sync impulse does not fulfill the technical requirements or when the transmission is not valid.

Remote command:

[TRIGger:A:MILStd:ERRor:SYNC](#) on page 654

Parity ← Error

Checks the parity of every word and triggers if the parity is even.

Remote command:

[TRIGger:A:MILStd:ERRor:PARity](#) on page 654

Manchester ← Error

Triggers if there is an error in the Manchester coding of the signal.

Remote command:

[TRIGger:A:MILStd:ERRor:MANChester](#) on page 653

Timeout ← Error

Triggers if the timeout is out of the set range. The range can be set in the "Bus type" = "MIL-STD-1553" > "Configuration" > "Timing setup" menu.

Remote command:

[TRIGger:A:MILStd:ERRor:TIMEout](#) on page 654

Command

Triggers on a command word that is specified in the submenu.

Cmd. Type ← Command

Selects the command type.

Symbolic ID ← Command

If a label list with node names was loaded and applied in the bus configuration, you can select simply the node name from the list instead of entering the numeric identifier.

The instrument triggers on the identifier of the selected node.

RT Address ← Command

Opens a submenu to set the RT address.

Compare ← RT Address ← Command

Sets the condition how the decoded value is compared with the defined range.

Remote command:

[TRIGger:A:MILStd:RTADdress:CONDition](#) on page 655

Edit Minimum/Edit Maximum ← RT Address ← Command

Opens the "Edit Minimum"/"Edit Maximum" submenu.

After setting the "Compare" condition, you can enter the value bit-by-bit by setting the state high, low, or do not care for each single bit. Alternatively, you can enter a hexadecimal value.

Remote command:

[TRIGger:A:MILStd:RTADdress:MAXimum](#) on page 655

[TRIGger:A:MILStd:RTADdress:MINimum](#) on page 655

Data Direction ← Command

Toggles the data direction of the selected command: T (transmit), R (receive), or X (either).

Remote command:

[TRIGger:A:MILStd:TRMode](#) on page 658

Sub Address ← Command

Sets the subaddress.

Compare ← Sub Address ← Command

Sets the condition how the decoded value is compared with the defined range.

Remote command:

[TRIGger:A:MILStd:SADdress:CONDition](#) on page 656

Edit Minimum/Edit Maximum ← Sub Address ← Command

Opens the "Edit Minimum"/"Edit Maximum" submenu.

After setting the "Compare" condition, you can enter the value bit-by-bit by setting the state high, low or do not care for each single bit. Alternatively, you can enter a hexadecimal value.

Remote command:

[TRIGger:A:MILStd:SADdress:MAXimum](#) on page 656

[TRIGger:A:MILStd:SADdress:MINimum](#) on page 656

Word Count ← Command

Sets the word count.

Compare ← Word Count ← Command

Sets the condition how the decoded value is compared with the defined range.

Remote command:

[TRIGger:A:MILStd:WCOUNT:CONDition](#) on page 658

Minimum ← Word Count ← Command

Sets the minimum of the word count range.

Remote command:

[TRIGger:A:MILStd:WCOUNT:MINimum](#) on page 659

Maximum ← Word Count ← Command

Sets the maximum of the word count range.

Remote command:

[TRIGger:A:MILStd:WCOUNT:MAXimum](#) on page 659

Sub Address ← Command

When "Cmd. Type" > "Mode Code" is selected, the subaddress selection is restricted to "0", "31" or "0 | 31"

Remote command:

[TRIGger:A:MILStd:SADdress:MCADdress](#) on page 656

Mode Code ← Command

Selects the type of mode code when "Command Type" > "Mode Code" is selected.

Remote command:

[TRIGger:A:MILStd:MCODE:CODE](#) on page 654

Status

Triggers on a status word that is specified.

See also [RT Address](#).

Status ← Status

Selects a status bit. For each bit, you can select the "State" to be triggered on.

See also: ["Status Word"](#) on page 302

Remote command:

[TRIGger:A:MILStd:STATus:BCReceived](#) on page 656

[TRIGger:A:MILStd:STATus:BUSY](#) on page 656

[TRIGger:A:MILStd:STATus:DBCaccept](#) on page 657

[TRIGger:A:MILStd:STATus:INSTRument](#) on page 657

[TRIGger:A:MILStd:STATus:MERRor](#) on page 657

[TRIGger:A:MILStd:STATus:SREquest](#) on page 657

[TRIGger:A:MILStd:STATus:SUBSystem](#) on page 657

[TRIGger:A:MILStd:STATus:TERMinal](#) on page 657

State ← Status

Toggles the logic state of the selected bit: 0 (low), 1 (high), or X (do not care).

Cmd. and data

Triggers on specified command and data.

Transmission ← Cmd. and data

Sets the transmission type: "BC-RT" (bus controller to remote terminal); "RT - BC" (remote terminal to bus controller), "RT - RT" (remote terminal to remote terminal), "Mode Code" with data.

Remote command:

[TRIGger:A:MILStd:TTYPe](#) on page 658

Data ← Cmd. and data

Triggers on a specified data.

Offset Compare ← Data ← Cmd. and data

Sets the condition how the decoded value is compared with the defined offset.

Remote command:

[TRIGger:A:MILStd:DATA:OFFSet:CONDition](#) on page 653

Offset ← Data ← Cmd. and data

Sets a word offset.

Remote command:

[TRIGger:A:MILStd:DATA:OFFSet](#) on page 653

Data Words ← Data ← Cmd. and data

Sets the number of words. Up to four words can be set.

Remote command:

[TRIGger:A:MILStd:DATA:WORDs](#) on page 653

Data Compare ← Data ← Cmd. and data

Sets the condition how the decoded value is compared with the defined range.

Remote command:

[TRIGger:A:MILStd:DATA:CONDition](#) on page 653

Minimum/Maximum ← Data ← Cmd. and data

Opens the "Minimum"/"Maximum" submenu.

After setting the "Compare" condition, you can enter the value bit-by-bit by setting the state high, low or do not care for each single bit. Alternatively, you can enter a hexadecimal value.

Remote command:

[TRIGger:A:MILStd:DATA:MAXimum](#) on page 653

[TRIGger:A:MILStd:DATA:MINimum](#) on page 653

12.8.4 MIL-STD-1553 Decode Results

When the configuration of the serial bus is complete, the signal can be decoded:

1. In the "Bus" menu, enable "Decode".
2. In the "Display" menu, select the result display settings.
See [Chapter 12.1.2, "Displaying Decode Results"](#), on page 233.
3. In the "Bus Table" menu, enable the "Bus Table". Adjust the table settings.
See also: [Chapter 12.1.3, "Bus Table: Decode Results"](#), on page 234

The instrument captures and decodes the signal according to the protocol definition and the configuration settings.

The color-coding of the various protocol sections and errors simplifies the interpretation of the visual display. The decode information condenses or expands, depending on the horizontal scale. Various data formats are available to show the result values.

Table 12-7: Content of the MIL-STD-1553 frame table

Column	Description
Start time	Time of word start in relation to the trigger point
Type	Word Type
RTA	RT address
Label	Symbolic label, available if a label list was loaded and applied
T/R	Data direction, transmit or receive
Sub	Subaddress
Length	Number of data bytes
Data	Hexadecimal values of the data bytes
RT/IMG	Response time/intermessage gap time
State	Overall state of the word

Remote commands are described in [Chapter 16.11.8.3, "MIL-1553 Decode Results"](#), on page 659.

12.8.5 MIL-STD-1553 Label List

Label lists are protocol-specific. A MIL-STD-1553 file contains three values for each identifier:

- "Symbolic label": symbolic name of addressed device, or the label of the sub address. The Labels are sorted in alphabetic order.
- "RT Addr.": hexadecimal remote terminal address value
- "Sub Addr": hexadecimal sub address value

Example: MIL PTT file

```
# -----
# Labels for MIL.1553 protocol
# Column order: RT address, RT label, Subaddress, Subaddress Label
# -----
@PROTOCOL_NAME = mil1553
0Ah,Engine,01h,Thrust
03h,Main panel,07h,Altimeter
03h,Main panel,01h,Speed
0Eh,Only RTA
```

12.9 ARINC 429 (Option R&S RTM-K7)

- [ARINC 429 Basics](#).....311
- [ARINC 429 Configuration](#).....312
- [ARINC 429 Trigger](#).....314
- [ARINC 429 Decode Results](#).....318
- [Search on Decoded ARINC 429 Data](#).....319
- [ARINC 429 Label List](#).....321

12.9.1 ARINC 429 Basics

The ARINC 429 is a specification that defines the characteristics of an avionic data bus used on commercial and transport aircraft.

In an ARINC 429 system, a single transmitter/source is connected to 1 to 20 receivers/sinks on one twisted wire pair. The bus uses differential signals. The ARINC 429 standard uses a simplex communication - data may be transmitted in only one direction. The information is transmitted over the bus in defined series of words.

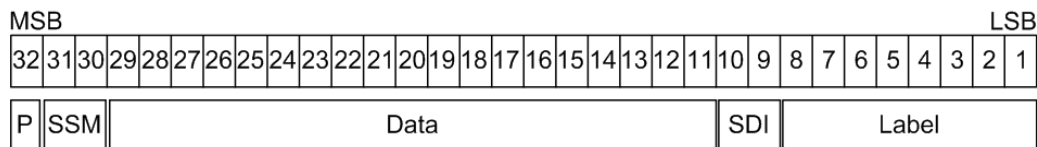
Word Format*Figure 12-46: Structure of an ARINC 429 word*

An ARINC 429 word is 32-bits and consists of the following parts (see [Figure 12-46](#)):

- Parity: the most significant bit (MSB). Checks if there are bit errors during the transmission. The total number of logic 1 bits for the word shall be odd.
- Sign/Status Matrix (SSM): the value of these bits depends on the data type. It may be used to report the status of hardware equipment.
- Data:
 - Binary (BNR): stores the data as a binary number.
 - Binary Coded Decimal (BCD): uses 4 data field bits to represent a decimal digit.
 - Discrete data: a combination of BNR and/ or BCD or individual bits that express specific equipment conditions.
 - Maintenance data and acknowledgment
 - Williamsburg / Buckhorn protocol: a bit-oriented protocol that is used for file transfer.
- Source/Destination Identifier (SDI): indicates the intended receiver or the transmitting subsystem.
- Label: gives information about the word's data type.

For comfortable analysis, you can load an editable label list, to interpret transferred numeric values as meaningful text labels.

12.9.2 ARINC 429 Configuration

The correct setup of the protocol parameters and the threshold is the condition for decoding the signal.

To set up and decode a ARINC 429 signal

1. Press the [Protocol] key in the Analysis area of the front panel.
2. Select the bus that you want to use: B1, B2, B3 or B4.
3. Select the "Bus Type" = ARINC 429.
4. Select "Configuration".
5. Select the "Source", the channel to which the input signal is connected.
6. Set the threshold:

- Tap "Find Threshold". The instrument evaluates the signal and sets the threshold.
 - Enter the threshold value in the numeric field.
7. Set the other signal parameters according to the signal characteristics. All settings are described below.
 8. In the "Bus" menu, enable "Decode".

ARINC 429 Configuration Settings

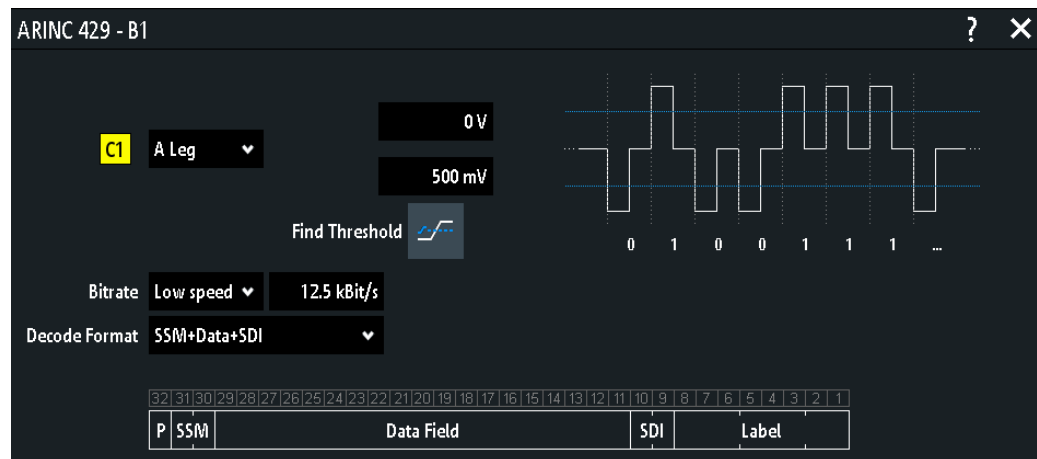

Figure 12-47: ARINC 429 setup dialog

Source

Sets the channel for the signal source.

Remote command:

[BUS:ARINC:SOURce](#) on page 672

Polarity

Sets the polarity of the bus.

Remote command:

[BUS:ARINC:POLarity](#) on page 672

Threshold, Find Threshold

Set the signal threshold for the source channel. Enter a value, or use "Find Threshold" to set the threshold to the middle reference level of the measured amplitude.

For analog channels, you can find the value also in the "Vertical" menu > "Channel <n>" > "Threshold"

For logic channels, you can find the value also in the "Logic" menu > "Technology".

Remote command:

[CHANnel<m>:THReshold](#) on page 421

[CHANnel<m>:THReshold:FINDlevel](#) on page 422

[DIGital<m>:THReshold](#) on page 739

Threshold High

Sets the upper threshold.

Remote command:

[BUS:ARINC:THReshold:HIGH](#) on page 673

Threshold Low

Sets the lower threshold.

Remote command:

[BUS:ARINC:THReshold:LOW](#) on page 673

Bit Rate

Sets the bit rate mode to high speed (100 kBit/s), low speed (12.5 kBit/s) or a user defined value.

Remote command:

[BUS:ARINC:BRMode](#) on page 672

[BUS:ARINC:BRValue](#) on page 672

Decode Format

Sets the decoding data format for the ARINC 429 bus: Data, SSM+Data, SSM+Data+SDI, Data+SDI.

Remote command:

[BUS:ARINC:DATA:FORMat](#) on page 677

12.9.3 ARINC 429 Trigger

Before you set up the trigger, make sure that the bus is configured correctly. See [Chapter 12.9.2, "ARINC 429 Configuration"](#), on page 312.

To trigger on ARINC 429 signals:

1. Press the [Protocol] key in the Analysis area of the front panel.
2. Select the bus that is configured for ARINC 429.
3. Select "Trigger".

This selection has several effects:

- Enables decoding, if necessary.
- Sets the "Trigger Type" to "Serial Bus" and the trigger source to the selected bus.
- Displays the "ARINC Trigger" condition in the dialog box, below the protocol setup.

4. At "ARINC Trigger", select the required trigger type:

- "Word": word start or word stop
- "Error": combination of protocol errors
- "Label": on a specified label.
- "Label and Data": combination of data and label condition

- "Transmission": on a transmission.
5. Set the other trigger parameters according to the signal characteristics. All settings are described below.

ARINC 429 Trigger Settings

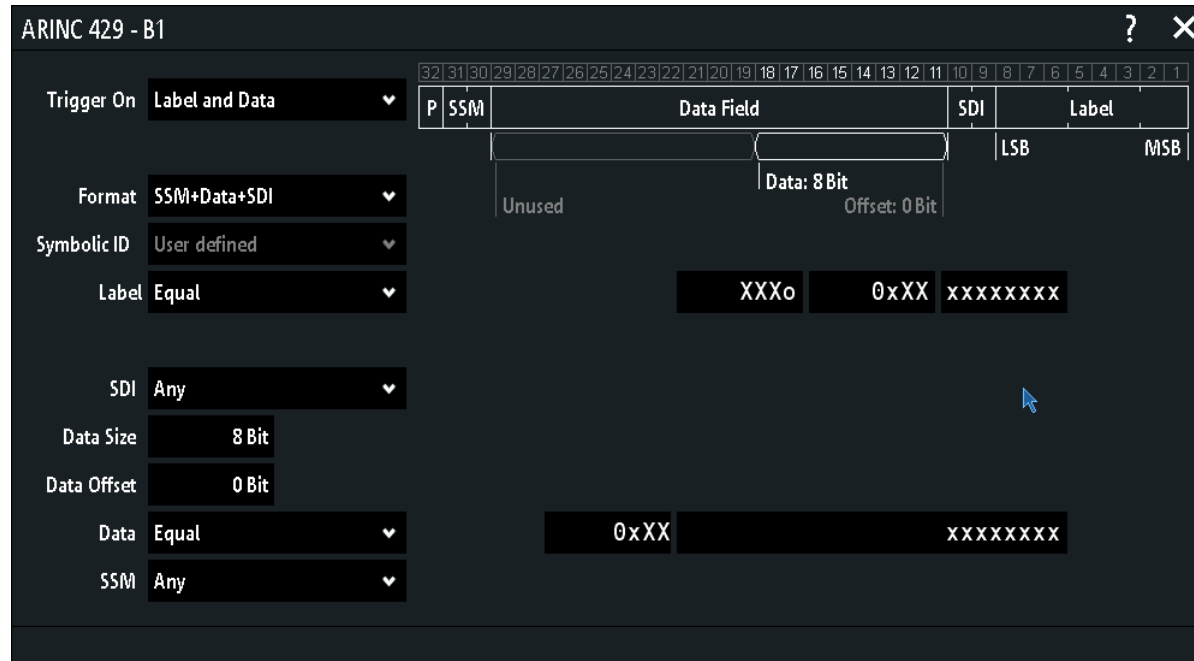

Figure 12-48: Trigger setup to trigger on label and data patterns

Word

Triggers on a word start or word stop.

Remote command:

[TRIGger:A:ARINC:WORD:TYPE](#) on page 677

Error

Triggers on any combination of protocol errors. Enable the error types that you want to trigger on.

"Parity" Checks the parity and triggers if the parity is even.

"Gap Error" Triggers on a gap error. The gap is calculated automatically from the set sample rate.

"Coding Error" Triggers on a coding error.

Remote command:

[TRIGger:A:ARINC:ERROR:PARity](#) on page 675

[TRIGger:A:ARINC:ERROR:GAP](#) on page 675

[TRIGger:A:ARINC:ERROR:CODing](#) on page 674

Label

Set the label settings to be triggered on.

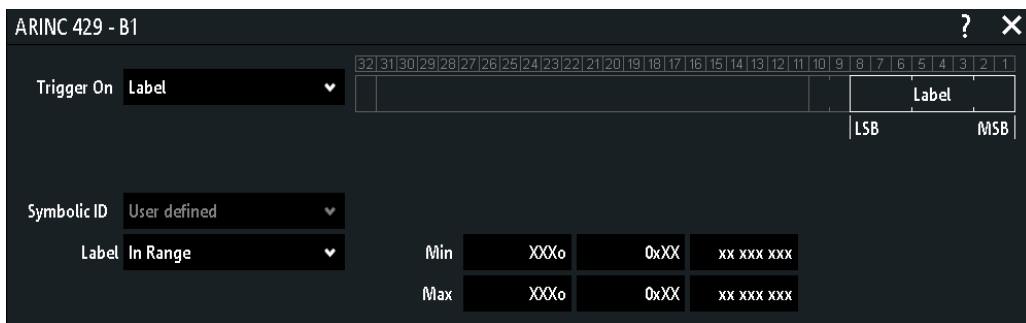

Symbolic ID ← Label

If a label list with node names was loaded and applied in the bus configuration, you can select simply the node name from the list instead of entering the numeric identifier. The instrument triggers on the identifier of the selected node.

Label and Data

Set the label and data settings to be triggered on. See also: [Symbolic ID](#)

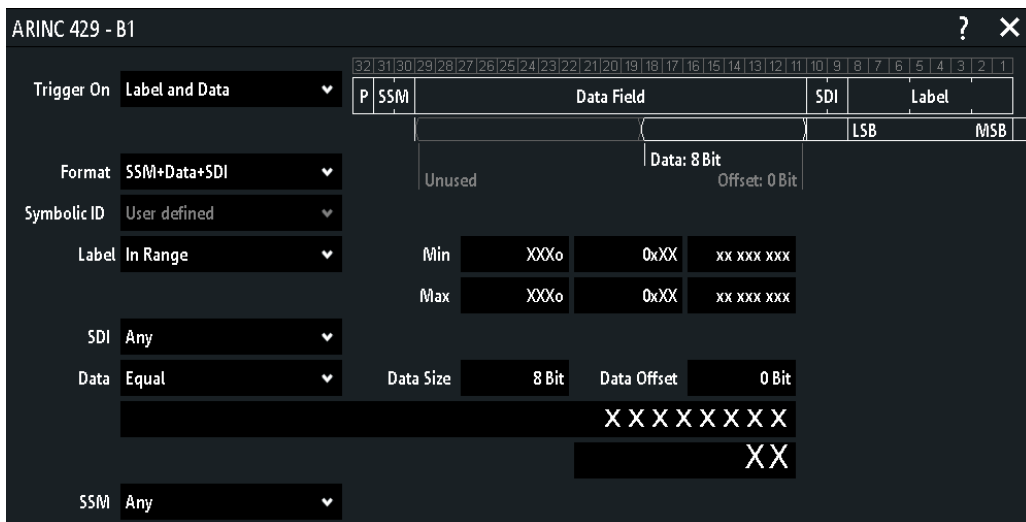

SSM ← Label and Data

Sets the values for the sign/status matrix (SSM) bits.

Remote command:

[TRIGger:A:ARINC:SSM](#) on page 676

SDI ← Label and Data

Sets the values for the source/destination identifier (SDI) bits.

Remote command:

[TRIGger:A:ARINC:SDI](#) on page 676

Data ← Label and Data

Triggers on a data, that is specified in the submenu.

Data Offset ← Data ← Label and Data

Sets a data offset.

Remote command:

[TRIGger:A:ARINc:DATA:OFFSet](#) on page 674

Data Size ← Data ← Label and Data

Sets the data size.

Remote command:

[TRIGger:A:ARINc:DATA:SIZE](#) on page 674

Compare ← Data ← Label and Data

Sets the condition how the decoded value is compared with the defined range.

Remote command:

[TRIGger:A:ARINc:DATA:CONDition](#) on page 673

Data ← Data ← Label and Data

After setting the "Compare" condition, you can enter the value bit-by-bit by setting the state high, low, or don't care for each single bit. Alternatively, you can enter a hexadecimal value for each byte.

Remote command:

[TRIGger:A:ARINc:DATA:MAXimum](#) on page 674

[TRIGger:A:ARINc:DATA:MINimum](#) on page 674

Transmission

Set a transmission conditions to be triggered on.

See also:

- ["Symbolic ID"](#) on page 316
- ["Label"](#) on page 315
- ["Data"](#) on page 316

Interval ← Transmission

Sets the condition how the decoded value is compared with the defined range.

Remote command:

[TRIGger:A:ARINc:TTIME:CONDition](#) on page 676

Minimum Time ← Transmission

Sets the minimum of the transmission time range.

Remote command:

[TRIGger:A:ARINc:TTime:MINimum](#) on page 676

Maximum Time ← Transmission

Sets the maximum of the transmission time range.

Remote command:

[TRIGger:A:ARINc:TTime:MAXimum](#) on page 676

12.9.4 ARINC 429 Decode Results

When the configuration of the serial bus is complete, the signal can be decoded:

1. In the "Bus" menu, enable "Decode".
2. In the "Display" menu, select the result display settings.
See [Chapter 12.1.2, "Displaying Decode Results"](#), on page 233.
3. In the "Bus Table" menu, enable the "Bus Table". Adjust the table settings.
See also: [Chapter 12.1.3, "Bus Table: Decode Results"](#), on page 234

The instrument captures and decodes the signal according to the protocol definition and the configuration settings.

The color-coding of the various protocol sections and errors simplifies the interpretation of the visual display. The decode information condenses or expands, depending on the horizontal scale. Various data formats are available to show the result values.

Table 12-8: Content of the ARINC 429 table

Column	Description
Start time	Time of word start in relation to the trigger point
Stop time	Time of word stop in relation to the trigger point
Label name	Symbolic label, available if a label list was loaded and applied
Label	The value of the label bytes
SDI	The state of the SDI bits
SSM	The state of the SSM bits
Data	The value of the data bytes
State	Overall state of the frame

Remote commands are described in [Chapter 16.11.9.3, "ARINC 429 Decode Results"](#), on page 677.

12.9.5 Search on Decoded ARINC 429 Data

Using the search functionality, you can find the same events in the decoded data which you also can trigger on. Unlike trigger, the search finds all events in an acquisition that fulfill the search condition. The results are listed in a table and can be saved to file.

To search for events in a ARINC 429 signal

1. Configure and decode the bus correctly.
2. Acquire decoded data.
3. Press the Search key.
4. Select the "Search Type" = "Protocol".
5. Select the "Source": the bus that is configured for ARINC 429 protocol.
6. Select the "Event" you want to search for.
7. Enter additional settings, depending on the event.

ARINC 429 search settings



Figure 12-49: Settings for search on ARINC 429 bus

Word

Searches for a word start or word stop.

Remote command:

[SEARCH:PROTOCOL:ARINC:WORD\[:TYPE\]](#) on page 684

Error

Searches for a protocol error.

"Parity" Checks the parity and triggers if the parity is even.

"Gap Error" Searches for a gap error. The gap is calculated automatically from the set sample rate.

"Coding Error" Searches for a coding error.

Remote command:

[SEARCH:PROTOCOL:ARINC:ERROR](#) on page 682

Label

Set the label settings to be searched for.

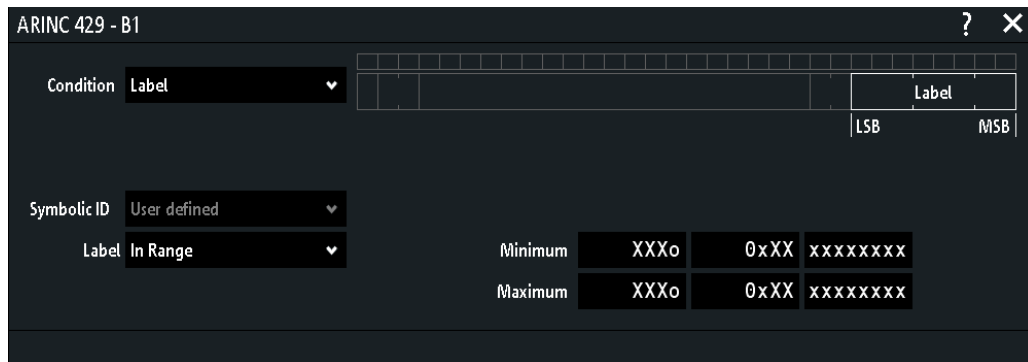

Symbolic ID ← Label

If a label list with node names was loaded and applied in the bus configuration, you can select simply the node name from the list instead of entering the numeric identifier.

The instrument searches for the identifier of the selected node.

Label and Data

Set the label and data settings to be searched for. See also: [Symbolic ID](#)

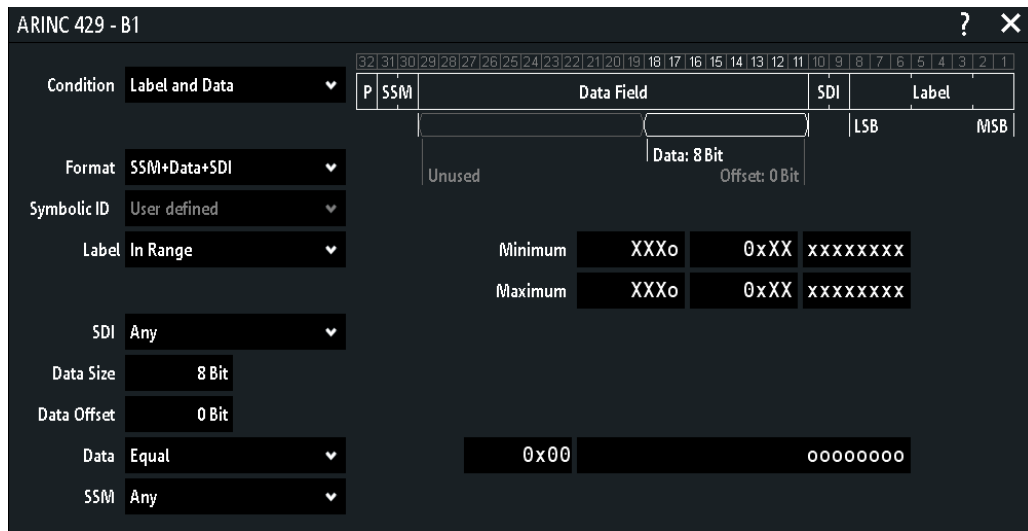

SSM ← Label and Data

Sets the values for the sign/status matrix (SSM) bits.

Remote command:

[SEARCH:PROTOCOL:ARINC:SSM](#) on page 683

SDI ← Label and Data

Sets the values for the source/destination identifier (SDI) bits.

Remote command:

[SEARCH:PROTOCOL:ARINC:SDI](#) on page 683

Data ← Label and Data

Searches for a data, that is specified in the submenu.

Data Offset ← Data ← Label and Data

Sets a data offset.

Remote command:

[SEARCH:PROTOCOL:ARINC:DATA:OFFSET](#) on page 682

Data Size ← Data ← Label and Data

Sets the data size.

Remote command:

[SEARCH:PROTOCOL:ARINC:DATA:SIZE](#) on page 682

Compare ← Data ← Label and Data

Sets the condition how the decoded value is compared with the defined range.

Remote command:

[SEARCH:PROTOCOL:ARINC:DATA:CONDITION](#) on page 681

Data ← Data ← Label and Data

After setting the "Compare" condition, you can enter the value bit-by-bit by setting the state high, low, or don't care for each single bit. Alternatively, you can enter a hexadecimal value for each byte.

Remote command:

[SEARCH:PROTOCOL:ARINC:DATA:MAXIMUM](#) on page 681

[SEARCH:PROTOCOL:ARINC:DATA:MINIMUM](#) on page 682

12.9.6 ARINC 429 Label List

Label lists are protocol-specific. An ARINC 429 file contains three values for each identifier:

- "Arinc Label": the Arinc 429 label value, that identifies the data type and the parameters associated with it.
- "Symbolic label": symbolic name of the label, specifying the device function.
- "Word Format": an optional parameter to describe the composition of the ARINC 429 word. It can be provided as integer value or mnemonic.

Word format definition

0 or DATA	= <P><	Data	><Label>
1 or DATA_SDI	= <P><	Data	><SDI><Label>
2 or DATA_SSM	= <P><SSM><	Data	><Label>

3 or DATA_SDI_SSM = <P><SSM>< Data ><SDI><Label>
 >3 or SYSTEM_DEFAULT or empty = Default format as defined in scope.

Example: ARINC 429 PTT file

```
# -----
@FILE_VERSION = 1.0
@PROTOCOL_NAME = arinc429
# -----
# Labels for ARINC protocol
# Column order: Numeric address (Label), Symbolic label, Word format
# -----
# ----Definition----
@PROTOCOL_NAME = arinc429
101o, Distance to Go, 0
102o, Time to Go, DATA_SDI
103o, Engine Discrete, DATA_SSM
104o, Latitude, 3
105o, Ground Speed, 4
106o, Magnetic heading
# -----
```

13 Power Analysis (Option R&S RTM-K31)

With the R&S RTM3000 and option R&S RTM-K31 you can perform power analysis measurements.

• Probe Adjustment.....	323
• Report Settings.....	324
• Statistic Menu Settings.....	325
• Input Power Measurements.....	326
• Output Power Measurements.....	339
• Switching Power Measurements.....	347
• Power Path Power Measurements.....	355

13.1 Probe Adjustment

13.1.1 Deskewing the Probes

Some power measurements require a current and a voltage probe. Before you start one of these measurements, you need to deskew the probes to get correct measurement results. The settings menu of the corresponding measurements contain the "Probe" function to adjust the probes.

Required equipment:

- R&S RT-ZF20 power deskew fixture
- Rohde & Schwarz voltage probe
- Rohde & Schwarz current probe

1. Connect the differential voltage probe and the current probe to the oscilloscope.
2. Press the Apps Selection key. Tap "Power Analysis".
3. Select a measurement.
4. In the configuration menu, select the correct channels for the "Current" and the "Voltage" sources.
5. Select the "Probe" menu.
6. Connect the probes to the R&S RT-ZF20 power deskew fixture.
7. "Deskew" the probes and adjust the "Zero Offset".
8. Disconnect the probes from the R&S RT-ZF20 power deskew fixture.

13.1.2 Probe Settings for Power Measurements

- ▶ To open the "Probe" settings menu:
 - a) Press the Apps Selection key. Tap "Power Analysis".
 - b) Select a measurement.
 - c) Close the "Power Analysis".
 - d) Tap the  menu icon in the lower right corner of the screen.
 - e) Scroll down. Select "Power".
 - f) In the "Power" menu, select "Probe".

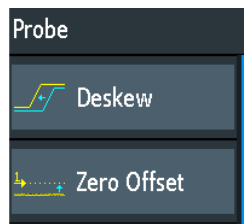

Deskew

Use the R&S RT-ZF20 power deskew fixture to deskew the probes.

Starts the automatic deskew procedure to align the waveforms of all visible channels. It is necessary to deskew if a current and a voltage probe is used in the measurement.

Remote command:

`POWER:DESKew[:EXECute]` on page 686

Zero Offset

Differences in DUT and oscilloscope ground levels may cause larger zero errors affecting the waveform. If the DUT is ground-referenced, the "Zero Offset" corrects the zero error of the probe to optimize measurement results at small signal levels.

Short the signal pin and the ground pin together and connect them to the ground of the DUT. Then press "Zero Offset".

Remote command:

`POWER:ZOFFset[:EXECute]` on page 686

13.2 Report Settings

In the "Report" menu you can describe your device under test (DUT) and the test conditions. This information can be used on the title page for a report generated from the "Power Analysis" measurements.

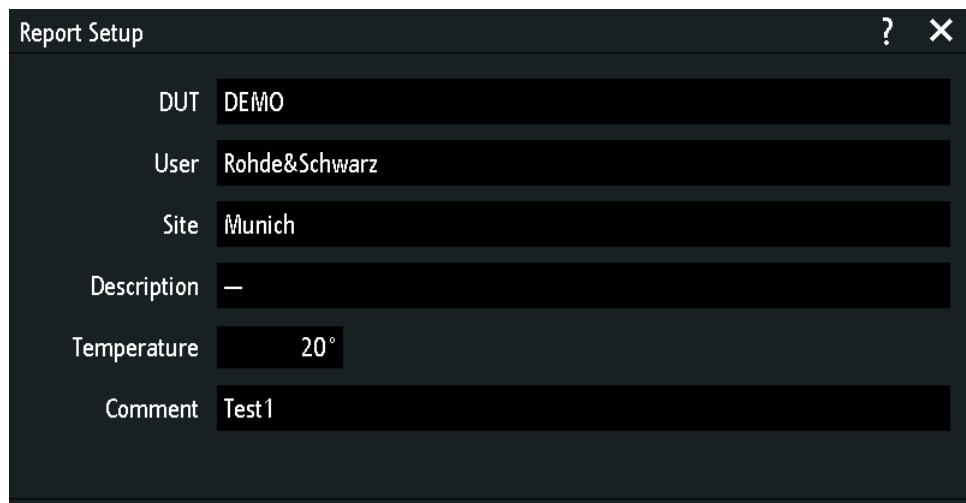

DUT	DEMO
User	Rohde&Schwarz
Site	Munich
Description	—
Temperature	20°
Comment	Test1

Report

Opens the "Report" menu to enter DUT and test information and start the result export.

"Device under test (DUT)" Enter a name for your DUT.

"User" Enter a user name.

"Site" Enter the site.

"Temperature" Enter the test temperature.

"Description" Enter a description for the test.

"Save" Opens the "Save" menu where you set the storage settings and save the report to the USB flash drive. The file name is assigned automatically.

Remote command:

[POWer:REPort:DUT](#) on page 687

[POWer:REPort:USER](#) on page 688

[POWer:REPort:SITE](#) on page 687

[POWer:REPort:TEMPerature](#) on page 687

[POWer:REPort:DESCRiption](#) on page 687

[POWer:REPort:OUTPut](#) on page 687

13.3 Statistic Menu Settings

In the statistic menu you can enable and configure statistic measurements. It is available only for some power measurements.

- ▶ To open the "Statistics" settings menu:
 - a) Press the Apps Selection key. Tap "Power Analysis".
 - b) Select a measurement.
 - c) Close the "Power Analysis".
 - d) Tap the  menu icon in the lower right corner of the screen.

- e) Scroll down. Select "Power".
- f) In the "Power" menu, select "Statistics".

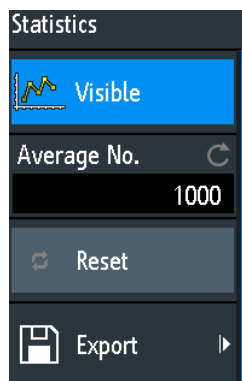
**Visible**

Activates or deactivates the statistical evaluation of the measurement.

Remote command:

[POWER:STATistics:VISible](#) on page 686

Average No.

Sets the number of measured waveforms used for calculation of average and standard deviation. The maximum number is 1000.

Reset

Deletes the statistical results for the current measurement or all measurements, respectively, and starts a new statistical evaluation if the acquisition is running.

Remote command:

[POWER:STATistics:RESet](#) on page 686

Export

Opens the "Export" menu to save the measurement results to a CSV file.

13.4 Input Power Measurements

Input line analysis is used to measure the characteristics of the input power and the effects the power supply exudes to the input line.

13.4.1 Quality

The power quality analysis measures the input voltage and current and the resulting power. The results characterize the quality of the input AC line.

13.4.1.1 Quality Results

The results of "Quality" measurements are:

- The voltage waveform
- The current waveform
- The power waveform that is the product of the current and voltage waveforms
- Numeric measurement results

Also, for each measurement result you can enable a statistic evaluation of the measurement results. It returns the current, minimum and maximum measurement values, the average and standard deviation, and the number of measured waveforms.

Voltage and current results

The voltage and current results are defined as follows:

Result	Description
RMS	Square root of the mean of the square of the current or voltage averaged over N cycles
Crest, crest factor	Peak value / RMS value
f, frequency	Frequency of the signal

Power results

The power in a system is described by several physical quantities: real power, reactive power, apparent power, and phase angle. In [Power diagram for sinusoidal signals](#) you can see how these quantities are related if the voltage and the current are sinusoidal signals. $||S||$ stands for the vector norm value of the vector S .

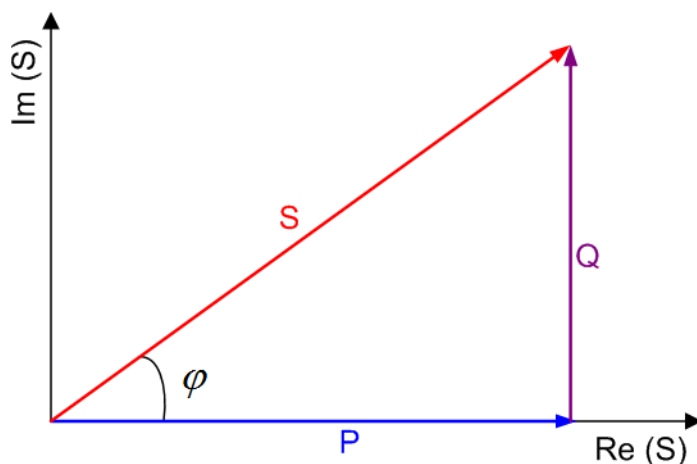

Figure 13-1: Power diagram for sinusoidal signals

P = real power [W]

Q = reactive power [VAR]

$||S||$ = apparent power [VA]

φ = phase angle between the current and the voltage sine waves [°]

The power results are defined as follows (see [Table 13-1](#)):

Table 13-1: Power results

Result	Name, Unit	Formula	Description
Apparent	Apparent power S (VA)	$ S = V_{RMS} \cdot I_{RMS}$ (averaged over N cycles)	S is the magnitude of the vector sum of real and reactive power.
Active	Real power P (W)	$P = V_{INSTANTENEOUS} \cdot I_{INSTANTENEOUS}$ (averaged over N cycles)	Energy of the system that can be used to do work.
Reactive	Reactive power Q (VAR, Volt-Ampere reactive)	$Q = S \sin \varphi$	Power flow that is temporarily stored in a system because of the inductive and capacitive elements.
Factor	Power factor P_{Factor}	$P_{Factor} = P / S $	Measure of the system efficiency. The value varies between -1 and 1.
Angle	Phase angle φ (°)	$\varphi = \arccos(P_{Factor})$	Phase angle between the current and the voltage sine waves.

Remote commands are described in [Chapter 16.12.11, "Quality"](#), on page 705.

13.4.1.2 Configuring Power Quality Measurements

For details of the configuration settings, see [Chapter 13.4.1.3, "Quality Settings"](#), on page 329.

1. Press the Apps Selection key. Tap "Power Analysis".
2. In the "Input" tab, select "Consumption".
3. Connect the differential voltage probe and the current probe to the oscilloscope. It is recommended that you use a high-voltage differential probe for measurements at the DUT power input.
4. Demagnetize the current probe. For details, see the user manual of your current probe.
5. Select the "Tools" tab.
6. Connect the probes to the R&S RT-ZF20 power deskew fixture.
7. "Deskew" the probes and adjust the "Zero Offset".
8. Disconnect the probes from the R&S RT-ZF20 power deskew fixture.
9. Connect the probes to the DUT as shown in the "Quality" dialog:
 - Connect the positive (+) signal socket of the differential voltage probe to the line of the AC input.
 - Connect the negative (-) signal socket of the differential voltage probe to the neutral of the AC input. Make sure that you use a common ground.

- Connect the current probe in flow direction of the current to the line of the AC input.
10. Close the "Power Analysis".
 11. Press the "Menu" button and scroll to the "Power" menu.
 12. Select the correct channels for the "Current" and the "Voltage" sources.
 13. To enable statistic evaluation of the measurement results, select "Statistics" > "Visible".
 14. Press the Autoset button to adjust the display scales automatically or adjust them manually.

On the screen, you can see the measurement waveforms of the current, the voltage and the power. Also, the numeric measurement results are shown in the lower left corner. For details, see [Chapter 13.4.1, "Quality"](#), on page 326.

13.4.1.3 Quality Settings

- ▶ To open the "Quality" settings menu:
 - a) Press the Apps Selection key. Tap "Power Analysis".
 - b) Select "Quality".

The screenshot shows the "Quality" settings menu in the Power Analysis application. The interface includes a top navigation bar with "Input", "Output", "Switching", "Power Path", and "Tools". The main area is titled "Quality" and features a central circuit diagram of a power supply. To the left, there are three menu items: "Quality" (with a waveform icon), "Consumption" (with a kWh meter icon showing "000123"), and "Inrush Current" (with a spike waveform icon). To the right, there are three more menu items: "Quality" (with a waveform icon), "Consumption" (with a kWh meter icon), and "Harmonics" (with a bar chart icon). Below the circuit diagram, there is a text description and three bullet points for connection instructions.

The power quality analysis measures the input voltage and current and the resulting power. The results characterize the quality of the input AC line.

- Connect the positive (+) signal socket of the differential voltage probe to the line of the AC input.
- Connect the negative (-) signal socket of the differential voltage probe to the neutral of the AC input. Make sure that you use a common ground.
- Connect the current probe in flow direction of the current to the line of the AC input.

- c) Close the "Power Analysis".
- d) Tap the  menu icon in the lower right corner of the screen.

e) Scroll down. Select "Power".

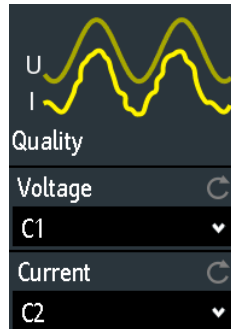

To adjust the probes, open the "Probe" menu. For details, see [Chapter 13.1.2, "Probe Settings for Power Measurements"](#), on page 324.

Voltage

Sets the channel for the voltage source input. It is recommended that you use a high-voltage differential probe for measurements at the DUT power input.

Remote command:

[POWer : SOURce : VOLTage<n>](#) on page 686

Current

Sets the channel for the current source. Connect the current probe in flow direction of the current.

Remote command:

[POWer : SOURce : CURRent<n>](#) on page 685

13.4.2 Consumption

The consumption analysis measures the input voltage, input current, and the resulting power. Using these values, it calculates the energy that is consumed over time. The consumption analysis is best suited for non periodical measurements, e.g. measuring the consumption of a device in a stand-by mode.

13.4.2.1 Consumption Results

The results of "Consumption" measurements are:

- the voltage waveform
- the current waveform
- the power waveform that is the product of the current and voltage waveforms
- numeric measurement results

For a definition of the numeric consumption results, see ["Power results"](#) on page 327.

Remote commands are described in [Chapter 16.12.4, "Consumption"](#), on page 688.

13.4.2.2 Configuring Consumption Measurements

For details of the configuration settings, see [Chapter 13.4.2.3, "Consumption Settings"](#), on page 331.

1. Press the Apps Selection key. Tap "Power Analysis".
2. In the "Input" tab, tap "Consumption".
3. Connect the differential voltage probe and the current probe to the oscilloscope. It is recommended that you use a high-voltage differential probe for measurements at the DUT power input.
4. Demagnetize the current probe. For details, see the user manual of your current probe.
5. Select the "Tools" tab.
6. Connect the probes to the R&S RT-ZF20 power deskew fixture.
7. "Deskew" the probes and adjust the "Zero Offset".
8. Disconnect the probes from the R&S RT-ZF20 power deskew fixture.
9. Connect the probes to the DUT:
 - Connect the positive (+) signal socket of the differential voltage probe to the line of the AC input.
 - Connect the negative (-) signal socket of the differential voltage probe to the neutral of the AC input. Make sure that you use a common ground.
 - Connect the current probe in flow direction of the current to the line of the AC input.
10. Close the "Power Analysis".
11. Press the "Menu" button and scroll to the "Power" menu.
12. Select the correct channels for the "Current" and the "Voltage" sources.
13. Press the Autoset button to adjust the display scales automatically or adjust them manually.

On the screen you can see the measurement waveforms of the current, the voltage and the power. Also, the numeric measurement results are shown in the lower left corner. For details, see [Chapter 13.4.2, "Consumption"](#), on page 330.

13.4.2.3 Consumption Settings

Required probes:

- Differential voltage probe
 - Current probe
- To open the "Consumption" settings menu:
- a) Press the Apps Selection key. Tap "Power Analysis".

b) In the "Input" tab, select "Consumption".

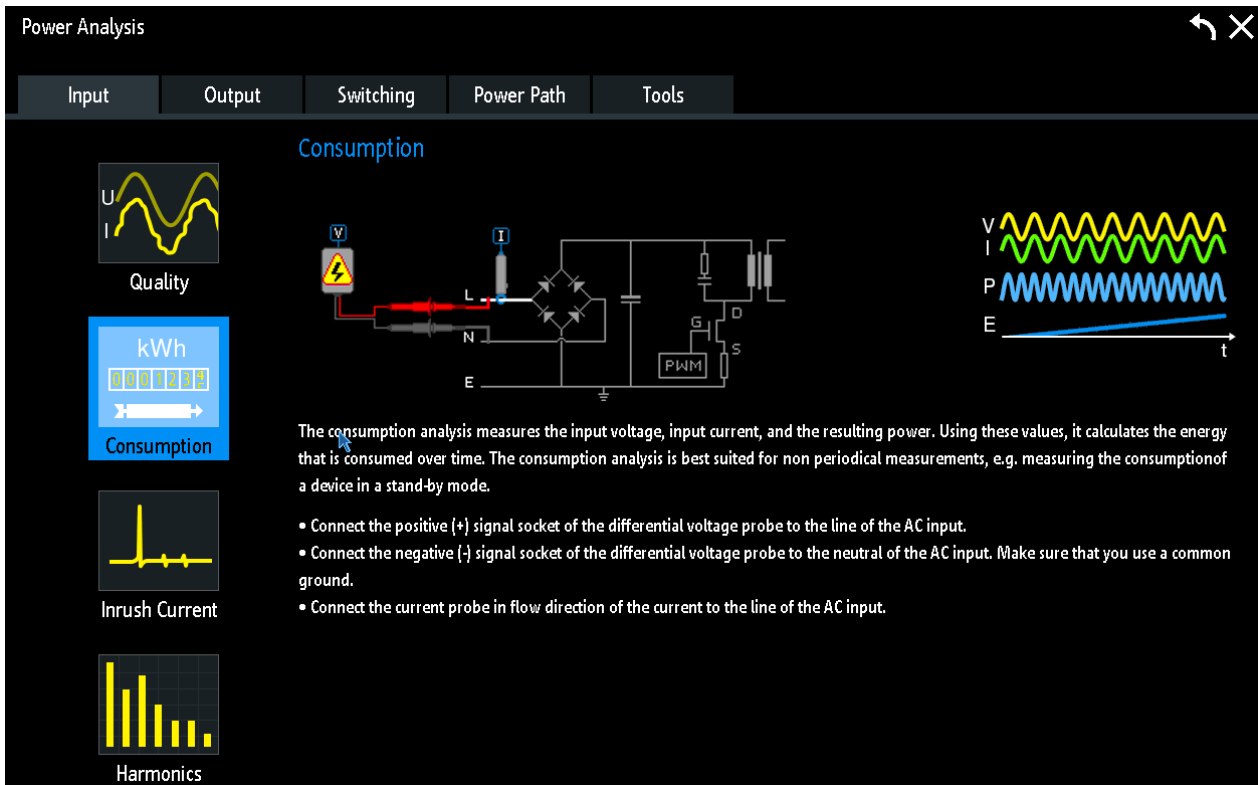

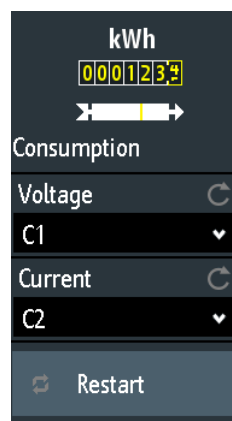

Figure 13-2: Setup of consumption analysis

- Close the "Power Analysis".
- Tap the  menu icon in the lower right corner of the screen.
- Scroll down. Select "Power".



To adjust the probes, open the "Probe" menu. For details, see [Chapter 13.1.2, "Probe Settings for Power Measurements"](#), on page 324.

The settings for the voltage and current sources are the same as for quality analysis, see ["Voltage"](#) on page 330 and ["Current"](#) on page 330.

Restart

Restarts the consumption measurement.

Remote command:

`POWer:CONSumption:REStart` on page 688

13.4.3 Harmonics

Current harmonics analysis measures the amplitude of frequency components that can be injected back into the AC lines. Therefore, FFT analysis with flat top window is performed. Current harmonics analysis also performs pre-compliance testing according to standards EN 61000-3-2 A / B / C / D.

13.4.3.1 Harmonics Results

The results of "Harmonics" measurements are:

- The voltage waveform
- The current waveform
- Numeric measurement results
- A bar that displays the measured value of the harmonics related to the value defined in the standard

You can export the results to file.

Table 13-2: Harmonics results

Result Table	Description
Order	The harmonic order
Frequency	The frequency value of the signal
Level	The level of the harmonic
Minimum	The minimum measured value
Maximum	The maximum measured value
Average	The average level of the harmonic
Limit bar chart	The value defined in the standard (white bar) and the measured value of the harmonics (green: value within the standard's defined limit; red: value out of the standard's defined limit)
Limit	The limit for the harmonic

Remote commands are described in [Chapter 16.12.7, "Current Harmonic"](#), on page 693.

13.4.3.2 Configuring Harmonics Measurements

For details of the configuration settings, see [Chapter 13.4.3.3, "Harmonics Settings"](#), on page 334.

1. Press the Apps Selection key. Tap "Power Analysis".
2. In the "Input" tab, tap "Harmonics".
3. Connect the differential voltage probe and the current probe to the oscilloscope. It is recommended that you use a high-voltage differential probe for measurements at the DUT power input.
4. If necessary, demagnetize the current probe. For details, see the user manual of your current probe.
5. Connect the probes to the DUT:
 - Connect the positive (+) signal socket of the differential voltage probe to the line of the AC input.
 - Connect the negative (-) signal socket of the differential voltage probe to the neutral of the AC input. Make sure that you use a common ground.
 - Connect the current probe in flow direction of the current to the line of the AC input.
6. Select the correct channels for the "Current" and the "Voltage" sources.
7. Select the "Standard".
8. Select the "Fundamental".
9. Press the Autoset button to adjust the display scales automatically or adjust them manually.

On the screen you can see the measurement waveforms of the current, the voltage and the power. Also, the numeric measurement results are shown in the result table. For details, see [Chapter 13.4.3.3, "Harmonics Settings"](#), on page 334.

13.4.3.3 Harmonics Settings

Required probes:

- Differential voltage probe
 - Current probe
- To open the "Harmonics" settings menu:
- a) Press the Apps Selection key. Tap "Power Analysis".

- b) In the "Input" tab, select "Harmonics".

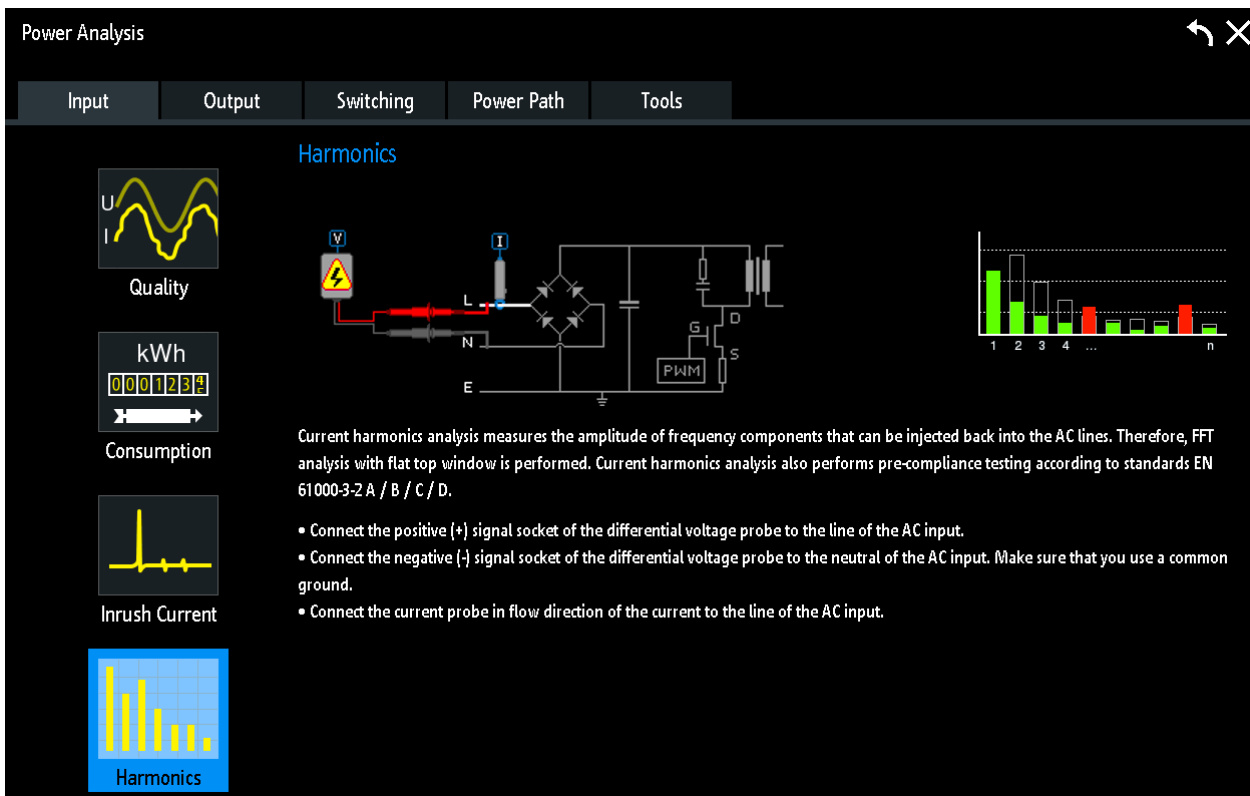

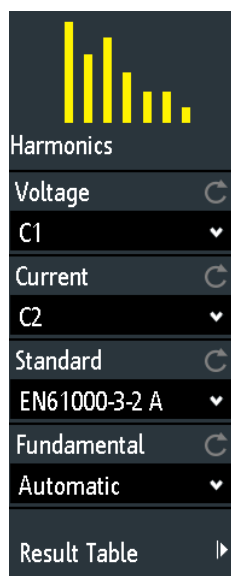

Figure 13-3: Setup of harmonics analysis

- c) Close the "Power Analysis".
- d) Tap the  menu icon in the lower right corner of the screen.
- e) Scroll down. Select "Power".



To adjust the probes, open the "Probe" menu. For details, see [Chapter 13.1.2, "Probe Settings for Power Measurements"](#), on page 324.

The settings for the voltage and current sources are the same as for quality analysis, see ["Voltage"](#) on page 330 and ["Current"](#) on page 330.

Standard

Selects the standard for pre-compliance testing.

"EN 61000-3-2 Class A"

Balanced 3-phase equipment, household appliances (excluding equipment identified as class D), tools (excluding portable tools), dimmers for incandescent lamps, audio equipment

"EN 61000-3-2 Class B"

Portable tools, not professional arc welding equipment

"EN 61000-3-2 Class C"

Lighting equipment

"EN 61000-3-2 Class D"

PC, PC monitors, radio, or TV receivers with an input power less than or equal to 600W

"MIL-STD-1399"

Military shipboard user equipment

"RTCA DO-160"

Environmental tests of avionics hardware

Remote command:

[POWER:HARMonics:STANdard](#) on page 698

Fundamental

Selects the frequency of the input signal. If "Automatic" is set, the instrument analyses the signal and sets the fundamental frequency accordingly. Available values depend on the selected "Standard".

Remote command:

[POWER:HARMonics:DOFRequency](#) on page 694

[POWER:HARMonics:ENFRequency](#) on page 694

[POWER:HARMonics:MIFRequency](#) on page 696

Export

"Export" opens the export menu to save the measurement results. You can set the target directory, file name, and a comment. The file format is CSV.

Remote command:

[EXPort:POWer:NAME](#) on page 699

[EXPort:POWer:SAVE](#) on page 699

13.4.4 Inrush Current

The inrush current analysis measures the peak of the input current that is drawn by the device, when the device is turned on.

13.4.4.1 Inrush Current Results

The results of "Inrush Current" measurements are:

- The current waveform
- Numeric measurement results:
 - "Peak1": the inrush current (maximum current) for the gate
 - " $\int y(x) \cdot x$ ": the area of the gate

Remote commands are described in [Chapter 16.12.8, "Inrush Current"](#), on page 699.

13.4.4.2 Configuring Inrush Current Measurements

For details of the configuration settings, see [Chapter 13.4.4.3, "Inrush Current Settings"](#), on page 337.

1. Press the Apps Selection key. Tap "Power Analysis".
2. In the "Input" tab, select "Inrush Current".
3. Connect the current probe to the oscilloscope.
4. Demagnetize and zero the current probe. For details, see the user manual of your current probe.
5. Connect the current probe in flow direction of the current to the line of the AC input of the DUT.
6. Select the correct channel for the "Current" source.
7. Set the "Gate Count".

On the screen, you can see the measurement waveform of the current. Also, the numeric measurement results are shown in the lower left corner. For details, see [Chapter 13.4.4.1, "Inrush Current Results"](#), on page 337.

13.4.4.3 Inrush Current Settings

- ▶ To open the "Inrush Current" settings menu:
 - a) Press the Apps Selection key. Tap "Power Analysis".

- b) In the "Input" tab, select "Inrush Current".

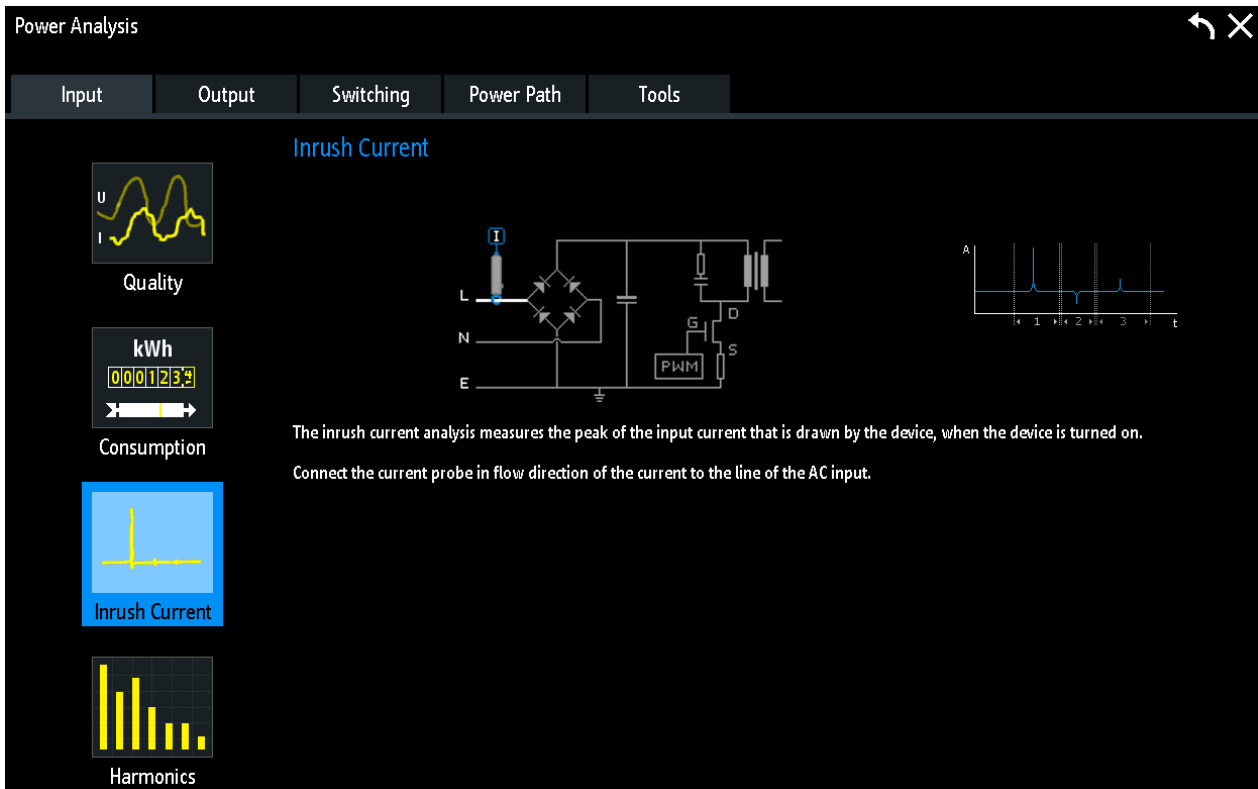

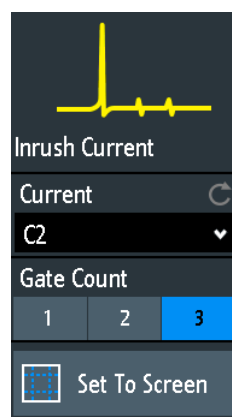

Figure 13-4: Setup of inrush current analysis

- c) Close the "Power Analysis".
 d) Tap the  menu icon in the lower right corner of the screen.
 e) Scroll down. Select "Power".



To adjust the probes, open the "Probe" menu. For details, see [Chapter 13.1.2, "Probe Settings for Power Measurements"](#), on page 324.

The settings for the current sources are the same as for quality analysis, see ["Current"](#) on page 330.

Gate Count

Sets the number of inrush current gates. You can select up to three gates.

Remote command:

`POWer:INRushcurrent:GCOunt` on page 700

`POWer:INRushcurrent:GATE<n>:START` on page 699

`POWer:INRushcurrent:GATE<n>:STOP` on page 699

Set to Screen

Resets the cursors to their initial positions. This is helpful if the cursors have disappeared from the display or need to be moved for a larger distance.

13.5 Output Power Measurements

Output analysis is used to measure the characteristics of the output voltage.

- [Ripple](#)..... 339
- [Spectrum](#)..... 342
- [Transient Response](#)..... 345

13.5.1 Ripple

The "Ripple" analysis measures the ripple of the device output. In this measurement the peak-to-peak extremes of the output DC signal are of interest. The measurement also includes the AC-RMS of the output DC signal, that is calculated as a standard derivation.

13.5.1.1 Ripple Results

The results of "Ripple" measurements are:

- The voltage waveform
- Numeric measurement results

Also, for each measurement result you can enable a statistic evaluation of the measurement results. It returns the current, minimum and maximum measurement values, the average and standard deviation, and the number of measured waveforms.

The numeric measurement results are defined as follows:

Table 13-3: Properties output ripple

Meas. type	Sym- bol	Description/Result
Peak +	Vp+	Maximum value within the displayed section of the waveform.
Peak -	Vp-	Minimum value within the displayed section of the waveform.
Peak peak	Vpp	Peak-to-peak value of the waveform: the difference of maximum and minimum values. $X_{Ampl} = X_{Max} - X_{Min}$

Meas. type	Sym- bol	Description/Result
Mean	<i>Mean</i>	Mean value of the complete displayed waveform.
σ	σ	Standard deviation of the waveform samples.
Period	<i>T</i>	The length of the left-most signal period within the displayed section of the waveform.
Frequency	<i>f</i>	Frequency of the signal. The result is based on the length of the left-most signal period within the displayed section of the waveform.
Pos. duty cycle	<i>Dty+</i>	Positive duty cycle: Width of a positive pulse in relation to the period in %. The measurement requires at least one complete period of a triggered signal.
Neg. duty cycle	<i>Dty-</i>	Negative duty cycle: Width of a negative pulse in relation to the period in %. The measurement requires at least one complete period of a triggered signal.

Remote commands are described in [Chapter 16.12.12, "Ripple"](#), on page 709.

13.5.1.2 Configuring Ripple Measurements

For details of the configuration settings, see [Chapter 13.5.1.3, "Ripple Settings"](#), on page 341.

1. Press the Apps Selection key. Tap "Power Analysis".
2. In the "Output" tab, tap "Ripple".
3. Connect the differential voltage probe and the current probe to the oscilloscope. It is recommended that you use a high-voltage differential probe for measurements at the DUT power input.
4. Demagnetize the current probe. For details, see the user manual of your current probe.
5. Select the "Tools" tab.
6. Connect the probes to the R&S RT-ZF20 power deskew fixture.
7. "Deskew" the probes and adjust the "Zero Offset".
8. Disconnect the probes from the R&S RT-ZF20 power deskew fixture.
9. Connect the probes to the DUT:
 - Connect the voltage probe to the output stage of the DUT.
 - Connect the current probe in flow direction of the current to the output stage of the DUT.
10. Close the "Power Analysis".
11. Press the "Menu" button and scroll to the "Power" menu.
12. Select the correct channels for the "Source".

13. Press the Autoset button to adjust the display scales automatically or adjust them manually.

On the screen you can see the measurement waveforms of the current, the voltage and the power. Also, the numeric measurement results are shown in the lower left corner. For details, see [Chapter 13.5.1.1, "Ripple Results"](#), on page 339.

13.5.1.3 Ripple Settings

Required probes:

- Voltage probe
- (Optional) Current probe

► To open the "Ripple" settings menu:

- a) Press the Apps Selection key. Tap "Power Analysis".
- b) In the "Output" tab, select "Ripple".

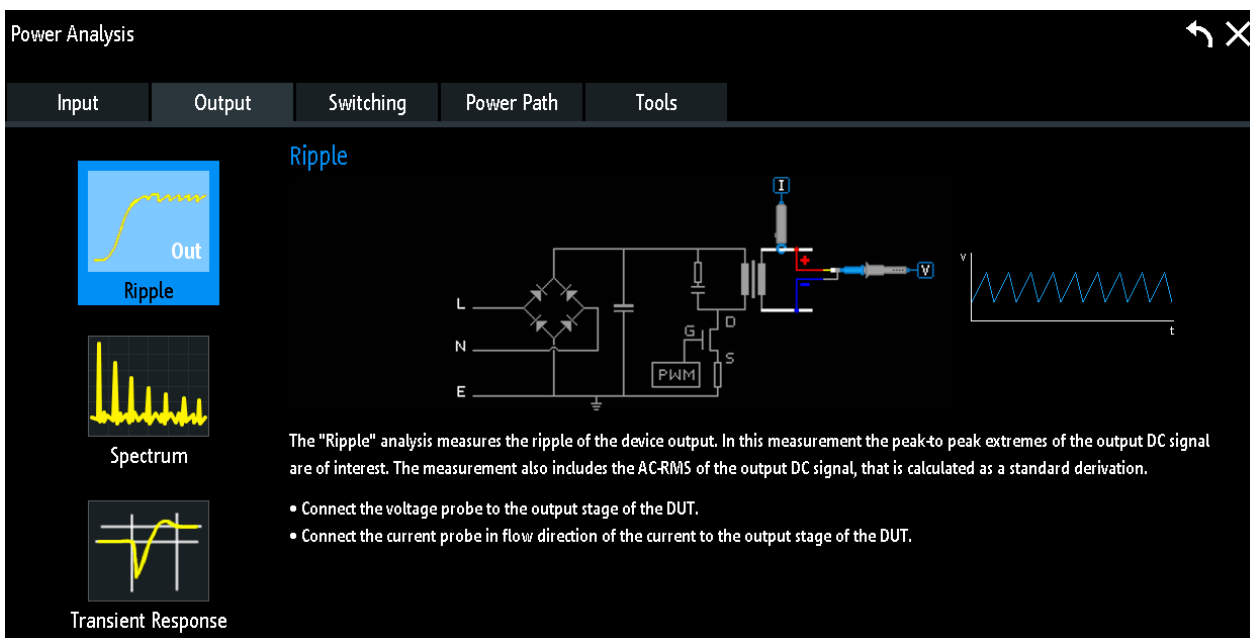

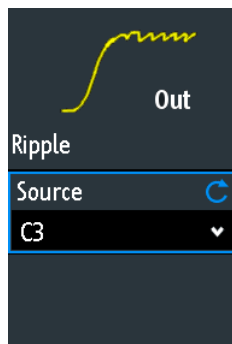

Figure 13-5: Setup of ripple analysis

- c) Close the "Power Analysis".
- d) Tap the  menu icon in the lower right corner of the screen.

e) Scroll down. Select "Power".



Source

Sets the channel for the source input. This can be either a current or a voltage source.

13.5.2 Spectrum

The spectrum analysis measures the spectrum of the output voltage. The results can be applied to see typical side effect problems of the switched-mode power supply (SMPS) application, such as switching frequency components of internal SMPS.

13.5.2.1 Spectrum Results

The results of "Spectrum" measurements are:

- Voltage waveform
- Spectrum
- Numeric measurement results

For a detailed description of the numeric parameters, see [Table 13-2](#).

Remote commands are described in [Chapter 16.12.15, "Spectrum"](#), on page 728.

13.5.2.2 Configuring Spectrum Measurements

For details of the configuration settings, see [Chapter 13.5.2.3, "Spectrum Settings"](#), on page 343.

1. Press the Apps Selection key. Tap "Power Analysis".
2. In the "Output" tab, tap "Spectrum".
3. Connect the differential voltage probe and the current probe to the oscilloscope. It is recommended that you use a high-voltage differential probe for measurements at the DUT power input.
4. Demagnetize the current probe. For details, see the user manual of your current probe.
5. Select the "Tools" tab.

6. Connect the probes to the R&S RT-ZF20 power deskew fixture.
7. "Deskew" the probes and adjust the "Zero Offset".
8. Disconnect the probes from the R&S RT-ZF20 power deskew fixture.
9. Connect the probes to the DUT:
 - Connect the voltage probe to the output stage of the DUT.
 - Connect the current probe in flow direction of the current to the output stage of the DUT.
10. Close the "Power Analysis".
11. Press the "Menu" button and scroll to the "Power" menu.
12. Select the correct channels for the "Source".
13. Press the Autoset button to adjust the display scales automatically or adjust them manually.

On the screen you can see the measurement waveforms of the current, the voltage and the spectrum. Also, the numeric measurement results are shown in the lower left corner. For details, see [Chapter 13.5.2.1, "Spectrum Results"](#), on page 342.

13.5.2.3 Spectrum Settings

Required probes:

- Differential voltage probe
 - Current probe
- To open the "Spectrum" settings menu:
- a) Press the Apps Selection key. Tap "Power Analysis".

b) In the "Output" tab, select "Spectrum".

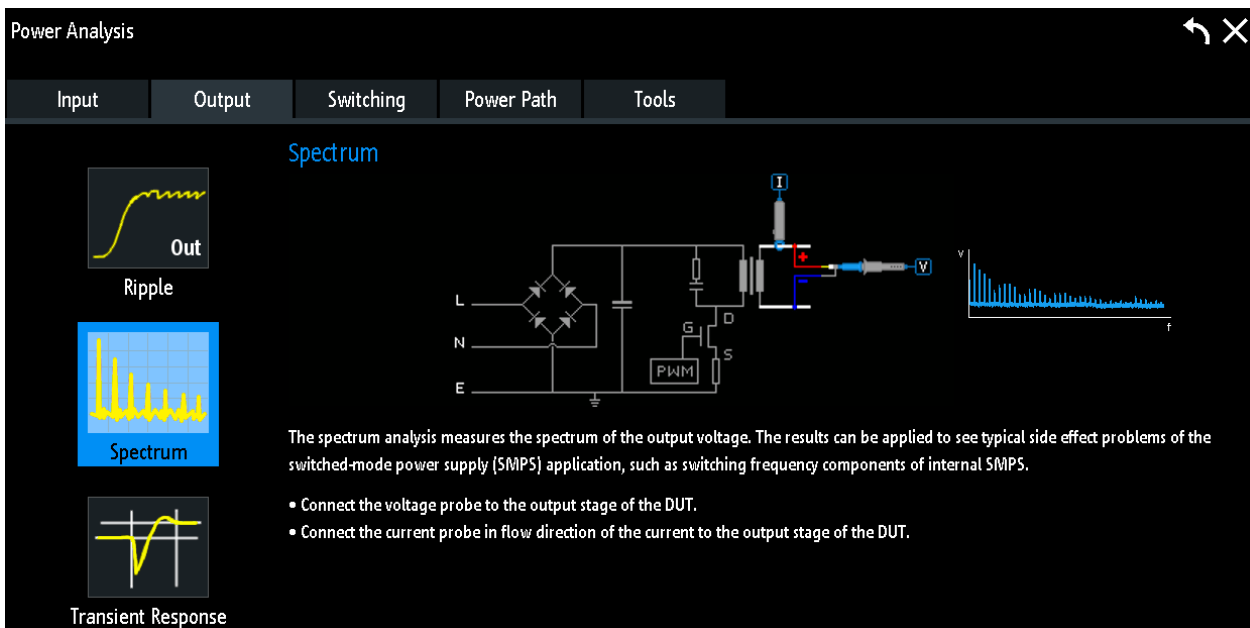

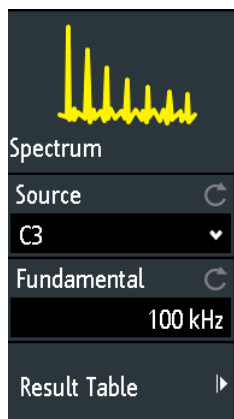

Figure 13-6: Setup of spectrum analysis

- c) Close the "Power Analysis".
- d) Tap the  menu icon in the lower right corner of the screen.
- e) Select "Power".



Source

Sets the channel for the source input. This can be either a current or a voltage source.

Fundamental

Sets the switching frequency of the device.

Remote command:

[POWER:SPECTrum:FREQUENCY](#) on page 728

Export

"Export" opens the export menu to save the measurement results. You can set the target directory, file name, and a comment. The file format is CSV.

Remote command:

`EXPort:POWer:NAME` on page 699

`EXPort:POWer:SAVE` on page 699

13.5.3 Transient Response

The transient response analysis measures the response of a system to a change from equilibrium. This response is described by different properties like the overshoot, the settling time, the peak time and the delay time.

13.5.3.1 Transient Response Results

The results of "Transient Response" measurements are:

- Voltage waveform
- Numeric measurement results

The transient response results are defined as follows:

Table 13-4: Transient response

Result	Symbol	Description
Rise time	tr	The time needed for the signal to change from 10% to 90% of the specified top level.
Overshoot level	Ovr	The maximum swing level above the top level.
Settling time	Sett.	The time period between cursor 1 and cursor 2.
Peak time	tPeak	The time needed for the response to reach the first peak of the overshoot.
Peak	Peak	The peak value of the signal
Delay time	Delay	The time needed for the response to reach half of the top level value, after the trigger event.

Remote commands are described in [Chapter 16.12.17, "Transient Response"](#), on page 735.

13.5.3.2 Configuring Transient Response Measurements

For details of the configuration settings, see [Chapter 13.5.3.3, "Transient Response Settings"](#), on page 346.

1. Press the Apps Selection key. Tap "Power Analysis".
2. In the "Output" tab, tap "Transient Response".
3. Close the "Power Analysis".

4. Connect the voltage probe to the oscilloscope.
5. Connect the voltage probe to the output stage of the DUT.
6. Press the "Menu" button and scroll to the "Power" menu.
7. Select the correct channels for the "Source".
8. Set the "Top Level" and the "Base Level".
9. Press the Autoset button to adjust the display scales automatically or adjust them manually.

On the screen, you can see the measurement waveforms of the voltage. Also, the numeric measurement results are shown in the lower left corner. For details, see [Chapter 13.5.3, "Transient Response"](#), on page 345.

13.5.3.3 Transient Response Settings

Required probes:

- Differential voltage probe
- To open the "Transient Response" settings menu:
- a) Press the Apps Selection key. Tap "Power Analysis".
 - b) In the "Output" tab, select "Transient Response".

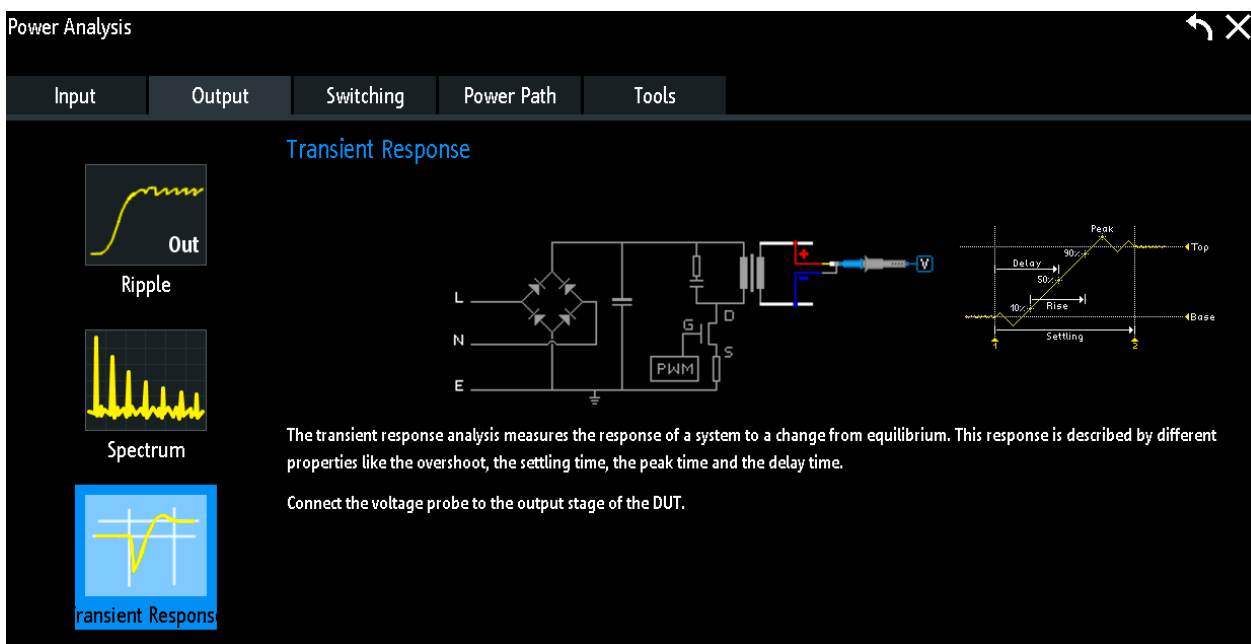

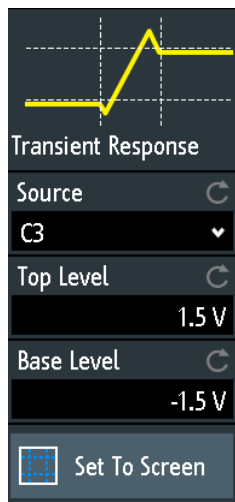

Figure 13-7: Setup of transient response analysis

- c) Close the "Power Analysis".
- d) Tap the  menu icon in the lower right corner of the screen.

e) Scroll down. Select "Power".



To adjust the probes, open the "Probe" menu. For details, see [Chapter 13.1.2, "Probe Settings for Power Measurements"](#), on page 324.

The settings for the sources is the same as for ripple analysis, see ["Source"](#) on page 342.

Top Level

Sets the expected signal high voltage value.

Remote command:

[POWER:TRANsient:SIGHigh](#) on page 736

Base Level

Sets the expected signal low voltage value.

Remote command:

[POWER:TRANsient:SIGLow](#) on page 736

Set to Screen

Resets the cursors to their initial positions. This is helpful if the cursors have disappeared from the display or need to be moved for a larger distance.

13.6 Switching Power Measurements

Switching and control loop analysis is used to measure the internal characteristics of a switching device and the operational reliability of the components.

- [Slew Rate](#).....348
- [Modulation](#).....350
- [Dynamic On Resistance](#).....353

13.6.1 Slew Rate

The slew rate analysis measures the rate of change of the voltage or current waveform during the switching of a switching transistor.

13.6.1.1 Slew Rate Results

The results of "Slew Rate" measurements are:

- the voltage waveform or the current waveform
- a waveform of the derivative of voltage and current
- numeric measurement results

For a detailed description of the numeric results, see [Chapter 13.5.1.1, "Ripple Results"](#), on page 339.

Also for each measurement result you can enable a statistic evaluation of the measurement results. It returns the current, minimum and maximum measurement values, the average and standard deviation, and the number of measured waveforms.

13.6.1.2 Configuring Slew Rate Measurements

For details of the configuration settings, see [Chapter 13.6.1.3, "Slew Rate Settings"](#), on page 349.

1. Press the Apps Selection key. Tap "Power Analysis".
2. In the "Switching" tab, tap "Slew Rate".
3. Connect the differential voltage probe and the current probe to the oscilloscope. It is recommended that you use a high-voltage differential probe for measurements at the DUT power input.
4. Demagnetize the current probe. For details, see the user manual of your current probe.
5. Select the "Tools" tab.
6. Connect the probes to the R&S RT-ZF20 power deskew fixture.
7. "Deskew" the probes and adjust the "Zero Offset".
8. Disconnect the probes from the R&S RT-ZF20 power deskew fixture.
9. Connect the probes to the DUT:
 - Connect the positive (+) signal socket of the differential probe to the drain of the transistor.
 - Connect the negative (-) signal socket of the differential probe to the source of the transistor.
 - Connect the current probe to the source of the transistor.
10. Close the "Power Analysis".

11. Press the "Menu" button and scroll to the "Power" menu.
12. Select the correct channels for the "Source".
13. Set the " Δt " value low enough.
14. To enable statistic evaluation of the measurement results, select "Statistics" > "Visible".
15. Press the Autoset button to adjust the display scales automatically or adjust them manually.

On the screen you can see the measurement waveforms of the current, the voltage and the derivative of voltage and current. Also, the numeric measurement results are shown in the lower left corner. For details, see [Chapter 13.6.1.1, "Slew Rate Results"](#), on page 348.

13.6.1.3 Slew Rate Settings

Required probes:

- Differential voltage probe
- Current probe

► To open the "Slew Rate" settings menu:

- a) Press the Apps Selection key. Tap "Power Analysis".
- b) In the "Switching" tab, select "Slew Rate".

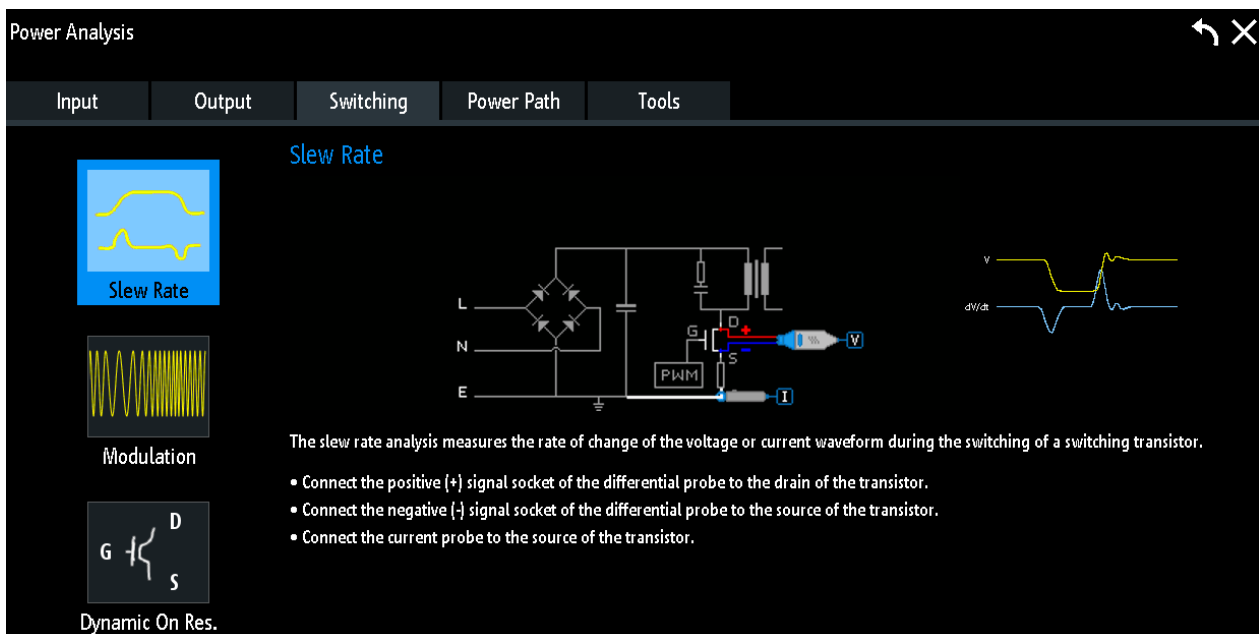

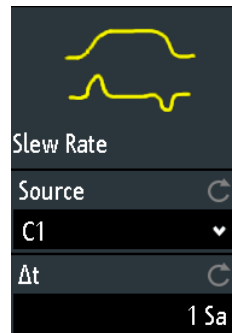

Figure 13-8: Setup of slew rate analysis

- c) Close the "Power Analysis".
- d) Tap the  menu icon in the lower right corner of the screen.

e) Scroll down. Select "Power".



To adjust the probes, open the "Probe" menu. For details, see [Chapter 13.1.2, "Probe Settings for Power Measurements"](#), on page 324.

Source

Sets the channel for the source. This can be either a current or a voltage source.

Δt

Sets the delta time.

Remote command:

[POWER:SLEWrate:DTIME](#) on page 716

13.6.2 Modulation

The modulation analysis measures the control pulse signal to a switching device.

13.6.2.1 Modulation Results

The results of "Modulation" measurements are:

- The voltage or the current waveform
- Numeric measurement results

For a detailed description of the numeric results, see [Chapter 13.5.1.1, "Ripple Results"](#), on page 339.

Also, for each measurement result you can enable a statistic evaluation of the measurement results. It returns the current, minimum and maximum measurement values, the average and standard deviation, and the number of measured waveforms.

13.6.2.2 Configuring Modulation Measurements

For details of the configuration settings, see [Chapter 13.6.2.3, "Modulation Analysis Settings"](#), on page 351.

1. Press the Apps Selection key. Tap "Power Analysis".
2. In the "Switching" tab, tap "Modulation".

3. Connect the differential voltage probe and the current probe to the oscilloscope. It is recommended that you use a high-voltage differential probe for measurements at the DUT power input.
4. Demagnetize the current probe. For details, see the user manual of your current probe.
5. Select the "Tools" tab.
6. Connect the probes to the R&S RT-ZF20 power deskew fixture.
7. "Deskew" the probes and adjust the "Zero Offset".
8. Disconnect the probes from the R&S RT-ZF20 power deskew fixture.
9. Connect the probes to the DUT:
 - Connect the positive (+) signal socket of the differential probe to the gate of the transistor.
 - Connect the negative (-) signal socket of the differential probe to the source of the transistor.
 - Connect the current probe to the drain of the transistor.
10. Close the "Power Analysis".
11. Press the "Menu" button and scroll to the "Power" menu.
12. Select the correct channels for the "Source".
13. Press the Autoset button to adjust the display scales automatically or adjust them manually.

On the screen you can see the measurement waveforms of the current, the voltage and the power. Also, the numeric measurement results are shown in the lower left corner. For details, see [Chapter 13.6.2.1, "Modulation Results"](#), on page 350.

13.6.2.3 Modulation Analysis Settings

Required probes:

- Differential voltage probe
 - Current probe
- To open the "Modulation" settings menu:
- a) Press the Apps Selection key.
 - b) Tap "Power Analysis".

- c) In the "Switching" tab, select "Modulation".

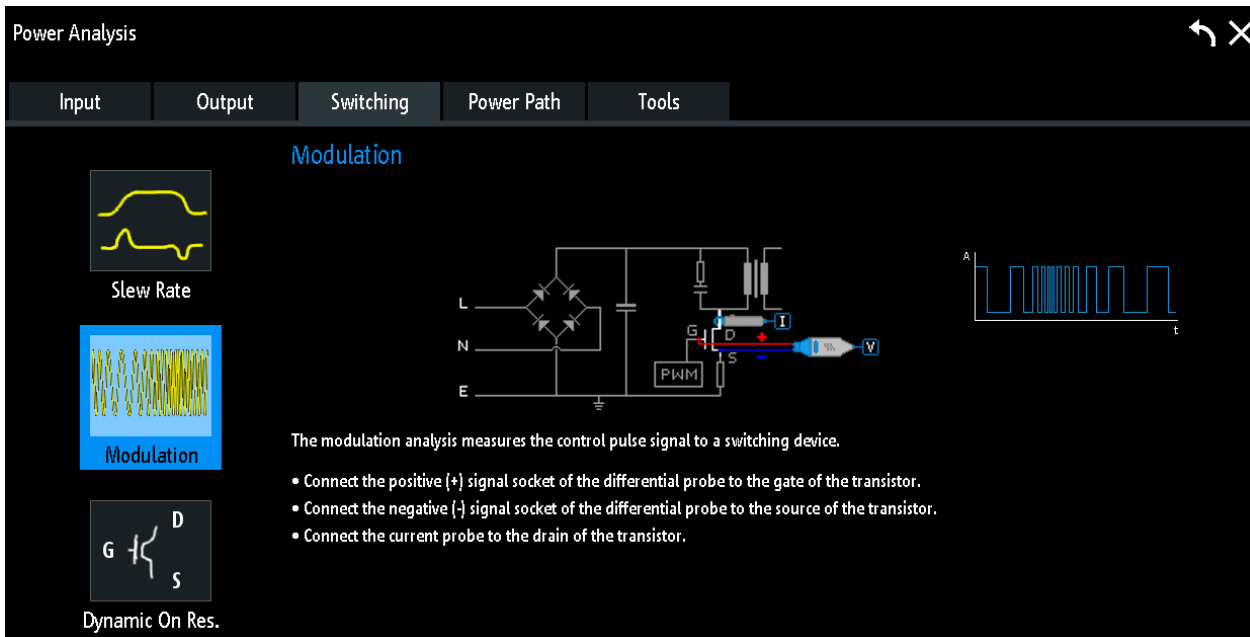

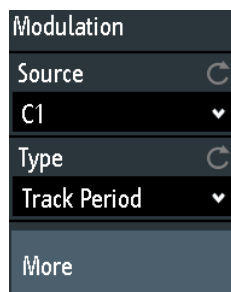

Figure 13-9: Setup of modulation analysis

- d) Close the "Power Analysis" box.
 e) Tap the  menu icon in the lower right corner of the screen.
 f) Scroll down. Select "Power".



To adjust the probes, open the "Probe" menu. For details, see [Chapter 13.1.2, "Probe Settings for Power Measurements"](#), on page 324.

Source

Sets the channel for the source. This can be either a current or a voltage source.

Type

Selects the modulation type. A calculation of the waveform for the selected modulation type is shown on the screen. The modulations types are the same as the track waveforms available in the math "Equation Set Editor".

Tap "More" to adjust the thresholds, hysteresis and reference edge for track calculation.

For details, see [Chapter 6.2.6, "Tracks"](#), on page 102.

Remote command:

`POWer:MODulation:TYPE` on page 701

`POWer:MODulation:THReshold[:UPPer]` on page 702

`POWer:MODulation:THReshold:LOWer` on page 702

`POWer:MODulation:THReshold:HYSTeresis` on page 702

13.6.3 Dynamic On Resistance

The dynamic On resistance analysis measures the resistance of a switching device, during operation. Because voltage and current may vary in time, the resistance is not constant, thus it is called dynamic On resistance. It is defined as the ratio dV/dI .

13.6.3.1 Dynamic On Resistance Results

The results of "Dynamic On Resistance" measurements are:

- the voltage waveform
- the current waveform
- the dynamic on resistance value

Remote commands are described in [Chapter 16.12.5, "Dynamic ON Resistance"](#), on page 690.

13.6.3.2 Configuring Dynamic On Resistance Measurements

For details of the configuration settings, see [Chapter 13.6.3.3, "Dynamic On Resistance Settings"](#), on page 354.

1. Press the Apps Selection key. Tap "Power Analysis".
2. In the "Switching" tab, tap "Dynamic On Res.".
3. Connect the differential voltage probe and the current probe to the oscilloscope. It is recommended that you use a high-voltage differential probe for measurements at the DUT power input.
4. Demagnetize the current probe. For details, see the user manual of your current probe.
5. Select the "Tools" tab.
6. Connect the probes to the R&S RT-ZF20 power deskew fixture.
7. "Deskew" the probes and adjust the "Zero Offset".
8. Disconnect the probes from the R&S RT-ZF20 power deskew fixture.
9. Connect the probes to the DUT:
 - Connect the positive (+) signal socket of the differential probe to the drain of the transistor.

- Connect the negative (-) signal socket of the differential probe to the source of the transistor.
 - Connect the current probe to the source of the transistor.
10. Close the "Power Analysis".
 11. Press the "Menu" button and scroll to the "Power" menu.
 12. Select the correct channels for the "Current" and the "Voltage" sources.
 13. Press the Autoset button to adjust the display scales automatically or adjust them manually.

On the screen, you can see the measurement waveforms of the current and the voltage. Also, the numeric measurement results are shown in the lower right corner. For details, see [Chapter 13.6.3.1, "Dynamic On Resistance Results"](#), on page 353.

13.6.3.3 Dynamic On Resistance Settings

Required probes:

- Differential voltage probe
- Current probe

► To open the "Dynamic On Res." settings menu:

- a) Press the Apps Selection key. Tap "Power Analysis".
- b) In the "Switching" tab, select "Dynamic On Res."

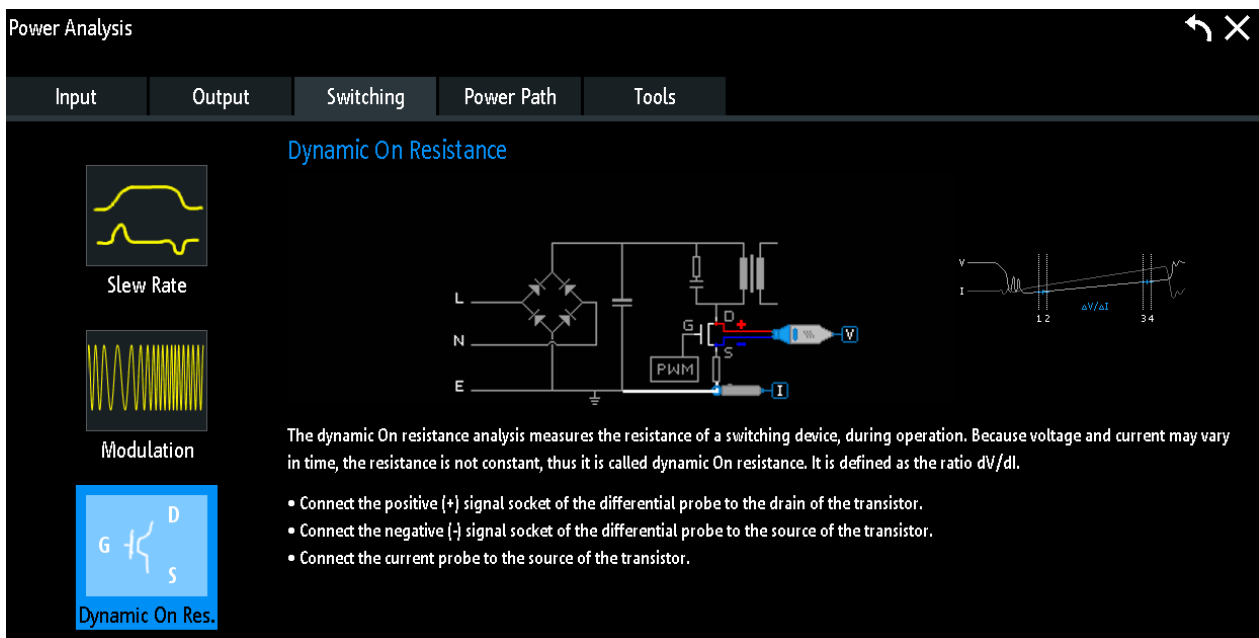

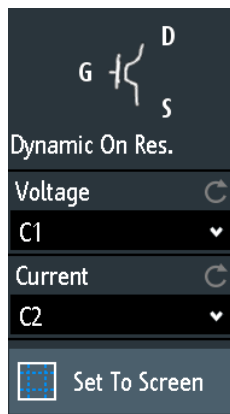

Figure 13-10: Setup of dynamic on resistance analysis

- c) Close the "Power Analysis".
- d) Tap the  menu icon in the lower right corner of the screen.

e) Scroll down. Select "Power".



To adjust the probes, open the "Probe" menu. For details, see [Chapter 13.1.2, "Probe Settings for Power Measurements"](#), on page 324.

The settings for the voltage and current sources are the same as for quality analysis, see ["Voltage"](#) on page 330 and ["Current"](#) on page 330.

Set to screen

Resets the cursors to their initial positions. This is helpful if the cursors have disappeared from the display or need to be moved for a larger distance.

13.7 Power Path Power Measurements

Power path measurements are used for analysing the behavior of the devices that control the power flow through the switched-mode power supply (SMPS) circuit, including switching devices and inductors.

- [Efficiency](#).....355
- [Switching Loss](#)..... 358
- [Turn ON/OFF Time](#)..... 361
- [Safe Operating Area \(S.O.A.\)](#)..... 364

13.7.1 Efficiency

The power efficiency analysis measures the input and the output power of a power supply. The power efficiency of the power supply is then calculated as the ratio of the output power and the input power.

13.7.1.1 Efficiency Results

The results of "Efficiency" measurements are:

- the voltage waveform
- the current waveform

- the power waveform that is the product of the current and voltage waveforms
- numeric measurement results

For a detailed description of the numeric results, see [Chapter 13.5.1.1, "Ripple Results"](#), on page 339.

Also, for each measurement result you can enable a statistic evaluation of the measurement results. It returns the current, minimum and maximum measurement values, the average and standard deviation, and the number of measured waveforms.

13.7.1.2 Configuring Efficiency Measurements

For details of the configuration settings, see [Chapter 13.7.1.3, "Efficiency Settings"](#), on page 357.

1. Press the Apps Selection key. Tap "Power Analysis".
2. In the "Power Path" tab, tap "Efficiency".
3. Connect the differential voltage probe and the current probe to the oscilloscope. It is recommended that you use a high-voltage differential probe for measurements at the DUT power input.
4. Demagnetize the current probe. For details, see the user manual of your current probe.
5. Select the "Tools" tab.
6. Connect the probes to the R&S RT-ZF20 power deskew fixture.
7. "Deskew" the probes and adjust the "Zero Offset".
8. Disconnect the probes from the R&S RT-ZF20 power deskew fixture.
9. Connect the probes to the DUT:
 - Connect the positive (+) signal socket of the first differential probe to the line of the AC input.
 - Connect the negative (-) signal socket of the first differential probe to the neutral of the AC input.
 - Connect the first current probe to the line of the AC input.
 - Connect the positive (+) signal socket of the second differential probe to the input path of the load.
 - Connect the negative (-) signal socket of the second differential probe to the return path of the load.
 - Connect the second current probe to the input path of the load with the direction of the arrow pointing towards the current flow.
10. Close the "Power Analysis".
11. Press the "Menu" button and scroll to the "Power" menu.
12. Select the correct channels for the "Input Voltage", "Input Current", "Output Voltage" and "Output Current" sources.

13. To enable statistic evaluation of the measurement results, select "Statistics" > "Visible".
14. Press the Autoset button to adjust the display scales automatically or adjust them manually.

On the screen, you can see the measurement waveforms of the currents and the voltages. Also, the numeric measurement results are shown in the lower right corner. For details, see [Chapter 13.7.1, "Efficiency"](#), on page 355.

13.7.1.3 Efficiency Settings

Required probes:

- Two differential voltage probes
- Two current probes

► To open the "Efficiency" settings menu:

- a) Press the Apps Selection key. Tap "Power Analysis".
- b) In the "Power Path" tab, select "Efficiency".

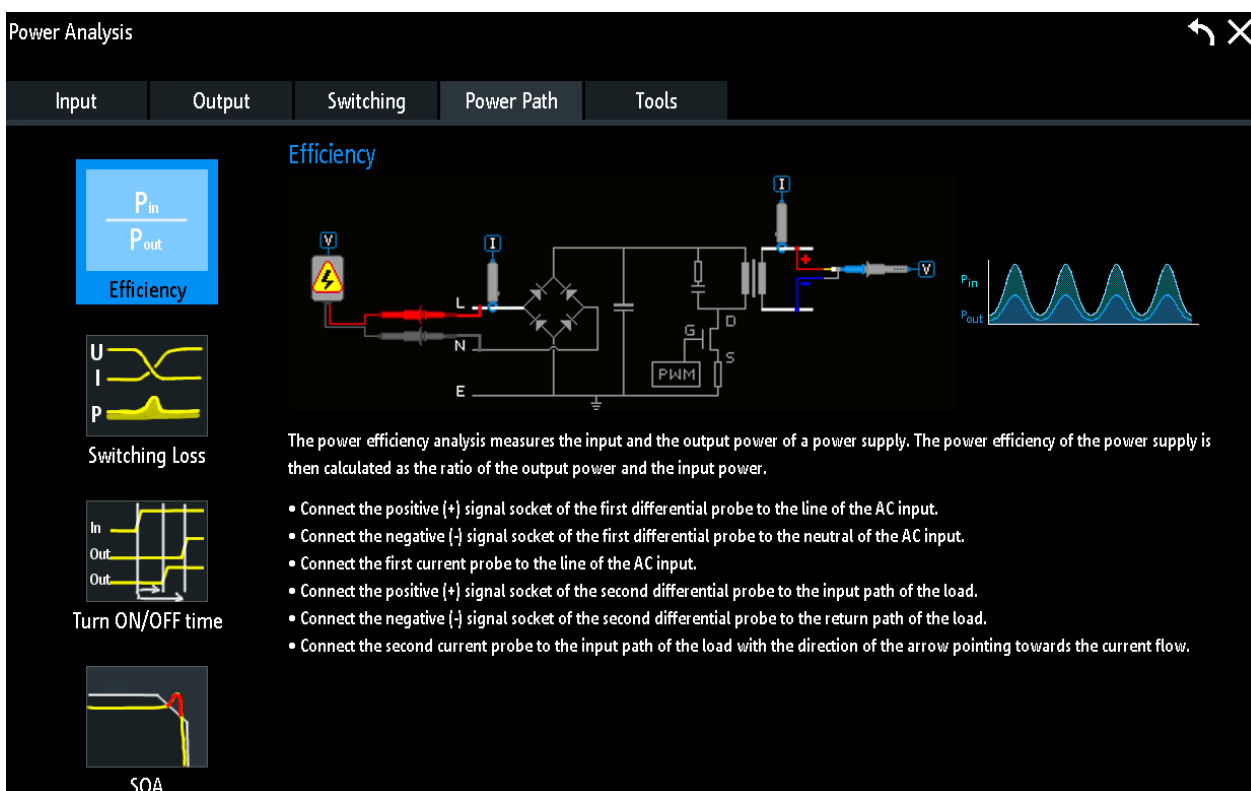

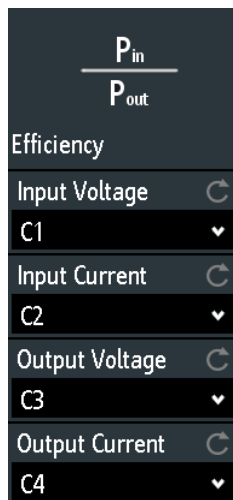

Figure 13-11: Setup of efficiency analysis

- c) Close the "Power Analysis".
- d) Tap the  menu icon in the lower right corner of the screen.

e) Scroll down. Select "Power".



To adjust the probes, open the "Probe" menu. For details, see [Chapter 13.1.2, "Probe Settings for Power Measurements"](#), on page 324.

Input Voltage, Input Current

Sets the channels for the input voltage and the input current.

Output Voltage, Output Current

Sets the channels for the output voltage and the output current.

13.7.2 Switching Loss

The switching loss analysis measures the power and energy losses of a switching device, that occur during the switching phases and the conduction phase of a switching transistor.

13.7.2.1 Switching Loss Results

The results of "Switching Loss" measurements are:

- The voltage waveform
- The current waveform
- The power waveform that is the product of the current and voltage waveforms
- Numeric measurement results

The numeric measurement results can be displayed in dependence of the power or the energy according to the selected "Type". The switching loss results show the power/energy values in W/J for the following switching phases:

Table 13-5: Switching loss phases

Phase	Symbol	Definition Points	Description
Turn on	On	The area between "t ₁ " and "t ₂ "	The time after switching the device, during which the current rises until it reaches the saturation current level.
Conduction	Cond	The area between "t ₂ " and "t ₃ "	The time during which the voltage is at the transistors saturated minimum and the current flows.
Turn off	Off	The area between "t ₃ " and "t ₄ "	The time during which after a short delay time the voltage rises until it reaches its final value.
Non con-duction	No Cond	The area between "t ₄ " and "t ₅ "	The time during current does not flow. The losses during this period should be theoretically zero.
Total	Total	The area between "t ₁ " and "t ₅ "	The period of one switching cycle.

Remote commands are described in [Chapter 16.12.16, "Switching"](#), on page 731.

13.7.2.2 Configuring Switching Loss Measurements

For details of the configuration settings, see [Chapter 13.7.2.3, "Switching Loss Settings"](#), on page 360.

1. Press the Apps Selection key. Tap "Power Analysis".
2. In the "Power Path" tab, tap "Switching Loss".
3. Connect the differential voltage probe and the current probe to the oscilloscope. It is recommended that you use a high-voltage differential probe for measurements at the DUT power input.
4. Demagnetize the current probe. For details, see the user manual of your current probe.
5. Select the "Tools" tab.
6. Connect the probes to the R&S RT-ZF20 power deskew fixture.
7. "Deskew" the probes and adjust the "Zero Offset".
8. Disconnect the probes from the R&S RT-ZF20 power deskew fixture.
9. Connect the probes to the DUT:
 - Connect the positive (+) signal socket of the differential probe to the drain of the transistor.
 - Connect the negative (-) signal socket of the differential probe to the source of the transistor.
 - Connect the current probe to the source of the transistor.
10. Close the "Power Analysis".

11. Press the "Menu" button and scroll to the "Power" menu.
12. Select the correct channels for the "Current" and the "Voltage" sources.
13. Select the "Type" for the measurement.
14. Press the Autoset button to adjust the display scales automatically or adjust them manually.

On the screen, you can see the measurement waveform of the current, the voltage and the power. Also, the numeric measurement results are shown in the lower right corner. For details, see [Chapter 13.7.2, "Switching Loss"](#), on page 358.

13.7.2.3 Switching Loss Settings

Required probes:

- Differential voltage probe
- Current probe

► To open the "Switching Loss" settings menu:

- a) Press the Apps Selection key. Tap "Power Analysis".
- b) In the "Power Path" tab, select "Switching Loss".

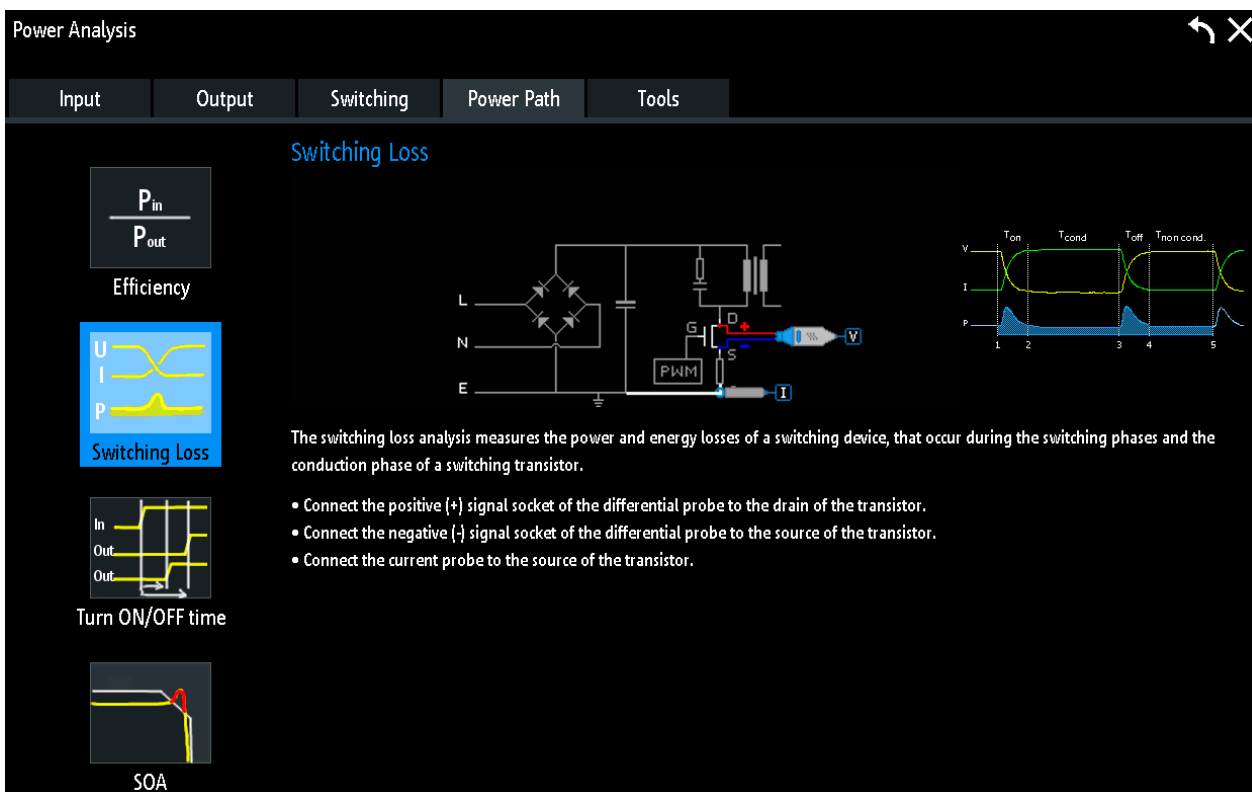

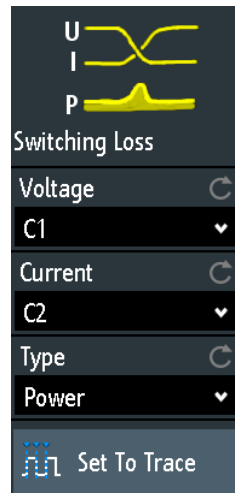

Figure 13-12: Setup of consumption analysis

- c) Close the "Power Analysis".
- d) Tap the  menu icon in the lower right corner of the screen.

e) Scroll down. Select "Power".



To adjust the probes, open the "Probe" menu. For details, see [Chapter 13.1.2, "Probe Settings for Power Measurements"](#), on page 324.

The settings for the voltage and current sources are the same as for quality analysis, see ["Voltage"](#) on page 330 and ["Current"](#) on page 330.

Type

Selects the measurement type, power or energy, for the switching loss measurement. The results of the measurement are displayed in W for power measurements and in J for energy measurements.

Remote command:

`POWER:SWITChing:TYPE` on page 734

Set to Trace

Autoset for cursor lines. Sets the cursor lines to typical points of the waveform depending on the selected measurement type.

13.7.3 Turn ON/OFF Time

The turn on/off analysis measures how long it takes a power supply to reach a certain percentage of the steady state output level during initial turn on or turn off.

13.7.3.1 Turn ON/OFF Time Results

The results of "Turn ON/OFF time" measurements are:

- The input voltage waveform
- The output voltage waveform
- The turn on / turn off time

Remote commands are described in [Chapter 16.12.10, "Turn On/Off"](#), on page 704.

13.7.3.2 Configuring Turn ON/OFF Time Measurements

For details of the configuration settings, see [Chapter 13.7.3.3, "Turn ON/OFF Time Settings"](#), on page 362.

1. Press the Apps Selection key. Tap "Power Analysis".
2. In the "Power Path" tab, select "Turn ON/OFF time".
3. Connect the differential voltage probe and the current probe to the oscilloscope. It is recommended that you use a high-voltage differential probe for measurements at the DUT power input.
4. Demagnetize the current probe. For details, see the user manual of your current probe.
5. Select the "Tools" tab.
6. Connect the probes to the R&S RT-ZF20 power deskew fixture.
7. "Deskew" the probes and adjust the "Zero Offset".
8. Disconnect the probes from the R&S RT-ZF20 power deskew fixture.
9. Connect the probes to the DUT:
 - Connect the positive (+) signal socket of the differential probe to the line of the AC input.
 - Connect the negative (-) signal socket of the differential probe to the neutral of the AC input.
 - Connect the passive voltage probe to the DC output of the DUT.
 - Connect the current probe to the input path of the load with the direction of the arrow pointing towards the current flow.
10. Select the correct channels for the "Input Voltage" and the "Output Voltage" sources.
11. Select the "Type" for the measurement.
12. Press the Autoset button to adjust the display scales automatically or adjust them manually.

On the screen, you can see the measurement waveform of the input and output voltage. Also, the numeric measurement results are shown in the lower left corner. For details, see [Chapter 13.7.3, "Turn ON/OFF Time"](#), on page 361.

13.7.3.3 Turn ON/OFF Time Settings

Required probes:

- Two voltage probes
 - Current probe
- To open the "Turn ON/OFF time" settings menu:

- a) Press the Apps Selection key. Tap "Power Analysis".
- b) In the "Power Path" tab, select "Turn ON/OFF time".

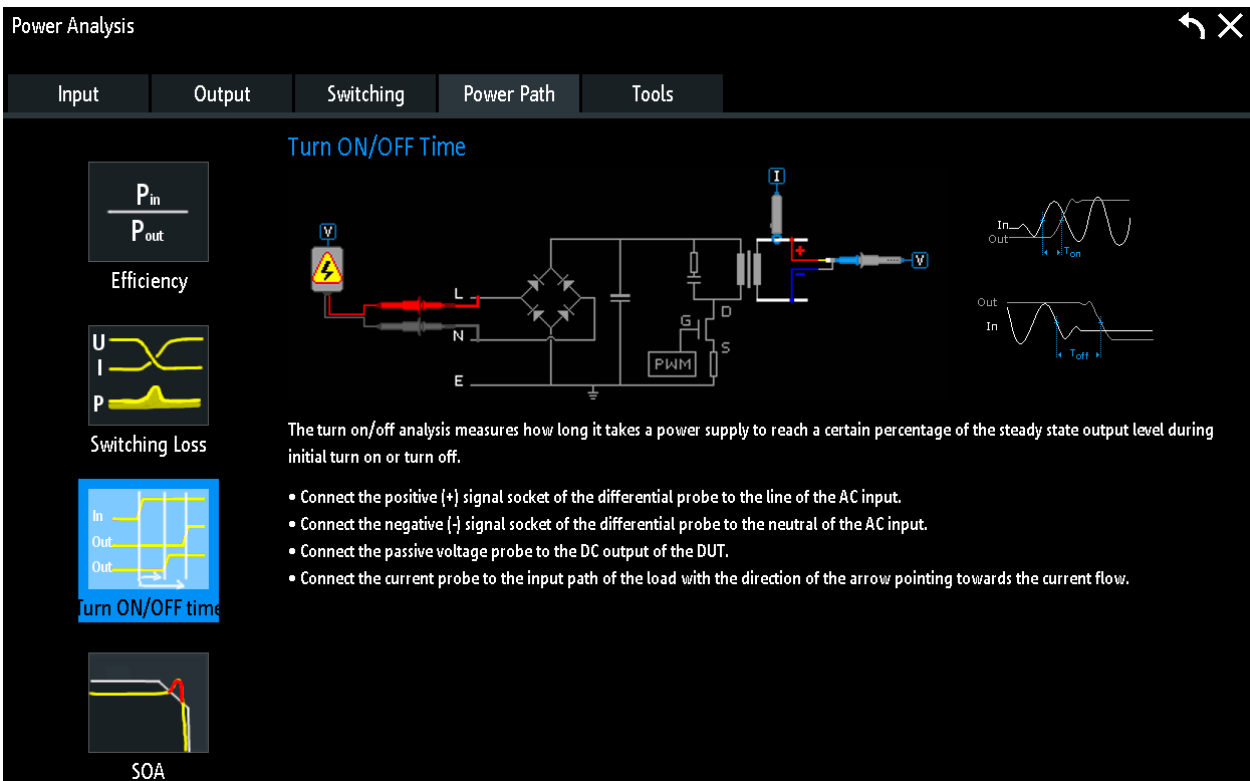

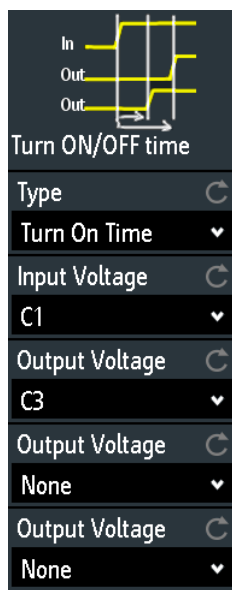

Figure 13-13: Setup of turn on/off analysis

- c) Close the "Power Analysis".
- d) Tap the  menu icon in the lower right corner of the screen.
- e) Scroll down. Select "Power".



To adjust the probes, open the "Probe" menu. For details, see [Chapter 13.1.2, "Probe Settings for Power Measurements"](#), on page 324.

Type

Selects turn on or turn off time as the type of measurement.

Input Voltage

Sets the channel for the input voltage.

Output Voltage

Sets the channels for the output voltage.

13.7.4 Safe Operating Area (S.O.A.)

The safe operating area is defined by the voltage and current conditions over which a power semiconductor device is expected to operate without self-damage. The "Safe Operating Area" analysis provides a diagram of the safe operating conditions of your device.

13.7.4.1 Safe Operating Area Results

The results of "SOA" measurements are provided in the following ways:

- The diagram shows the graphical presentation of:
 - the voltage waveform
 - the current waveform
- A logarithmic or linear XY diagram of the calculated voltage (x-axis) and current (y-axis) waveforms. This curve is a graphical representation of the power handling capability of the device under various conditions.

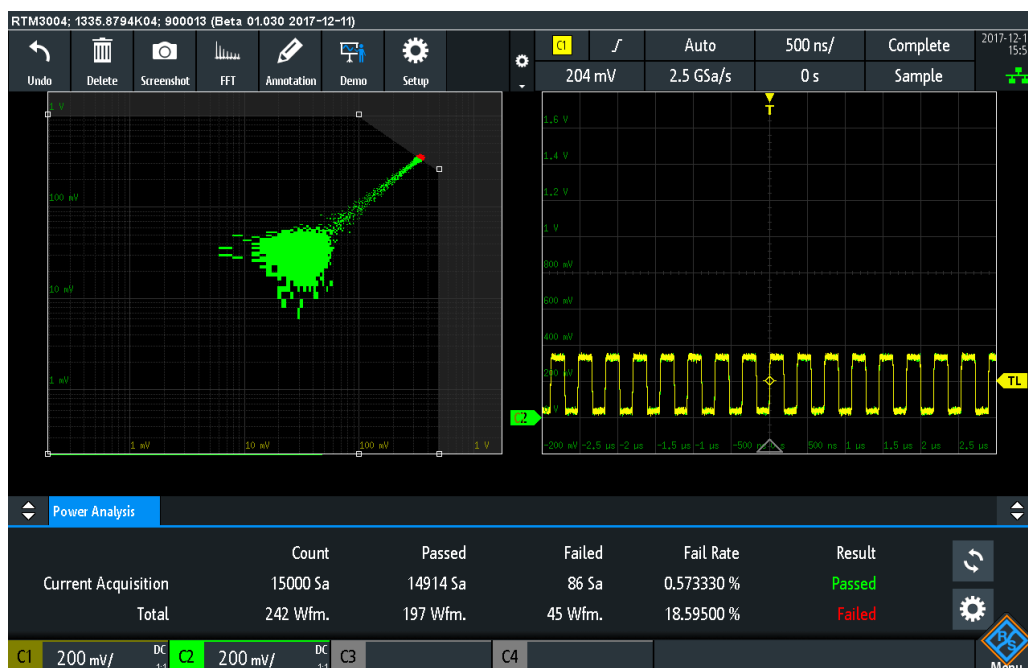

Figure 13-14: Results of the SOA power measurement

The numerical results of the safe operating area mask test are described in Table 13-6.

Table 13-6: Results of the mask test

Result	Description
Count	Number of tested points/acquisitions
Passed	Number of points/acquisitions that have passed the mask test, i.e. they are within the defined safe operating area mask
Failed	Number of points/acquisitions that have failed the mask test, i.e. they are out of the defined safe operating area mask
Fail rate	Ratio of acquisition hits to the number of tested acquisitions
Result	A test has failed if the number of sample hits or acquisition hits exceeds the limit of "Tot.Tolerance" / "Acq. Tolerance" hits

Remote commands are described in Chapter 16.12.14, "S.O.A", on page 720.

13.7.4.2 Configuring Safe Operating Area Measurements

For details of the configuration settings, see Chapter 13.7.4.3, "Safe Operating Area Settings", on page 366.

1. Press the Apps Selection key. Tap "Power Analysis".
2. In the "Power Path" tab, tap "SOA".

3. Connect the differential voltage probe and the current probe to the oscilloscope. It is recommended that you use a high-voltage differential probe for measurements at the DUT power input.
4. Demagnetize the current probe. For details, see the user manual of your current probe.
5. Select the "Tools" tab.
6. Connect the probes to the R&S RT-ZF20 power deskew fixture.
7. "Deskew" the probes and adjust the "Zero Offset".
8. Disconnect the probes from the R&S RT-ZF20 power deskew fixture.
9. Connect the probes to the DUT:
 - Connect the positive (+) signal socket of the differential probe to the drain of the transistor.
 - Connect the negative (-) signal socket of the differential probe to the source of the transistor.
 - Connect the current probe to the source of the transistor.
10. Close the "Power Analysis".
11. Press the "Menu" button and scroll to the "Power" menu.
12. Select the correct channels for the "Current" and the "Voltage" sources.
13. Open the "Mask Setup" menu and define the mask parameters.
14. Open the "Test Setup" menu and define the test parameters.
15. Press the Autoset button to adjust the display scales automatically or adjust them manually.

On the screen, you can see the measurement waveforms of the currents and the voltages. Also, the numeric measurement results are shown in the lower right corner. For details, see [Chapter 13.7.4.1, "Safe Operating Area Results"](#), on page 364.

13.7.4.3 Safe Operating Area Settings

Required probes:

- Differential voltage probes
- Current probe

► To open the "Efficiency" settings menu:

- a) Press the Apps Selection key. Tap "Power Analysis".

b) In the "Power Path" tab, select "SOA".

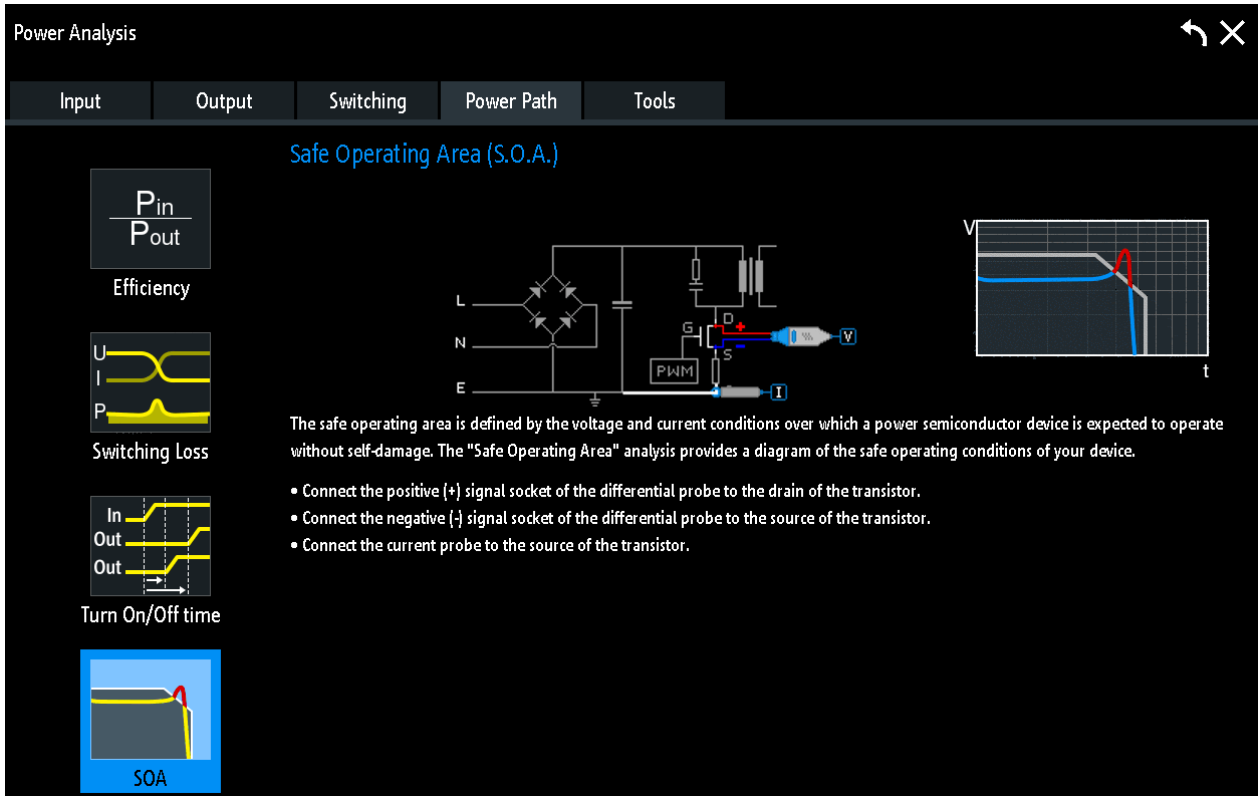

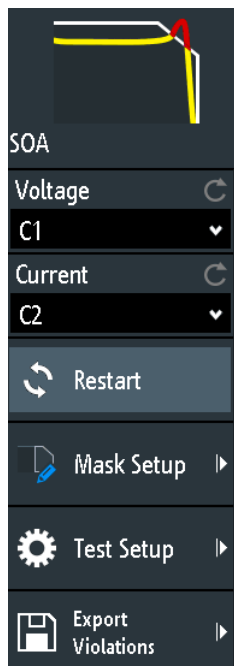

Figure 13-15: Setup of SOA analysis

- Close the "Power Analysis".
- Tap the  menu icon in the lower right corner of the screen.
- Scroll down. Select "Power".

General Settings



The settings for the voltage and current sources are the same as for quality analysis, see "[Voltage](#)" on page 330 and "[Current](#)" on page 330.

Restart

Restarts the SOA measurement.

Remote command:

[POWer:SOA:REStArt](#) on page 728

Mask Setup

Opens a menu for configuring the mask, see "[Mask Settings](#)" on page 368.

Test Setup

Opens a menu to define the tolerance of the test setup as well as the window scale, see "[Test Settings](#)" on page 370.

Export Violations

Opens a menu to save the measurement results to an Excel file.

Mask Settings

In this menu you can define the mask settings.

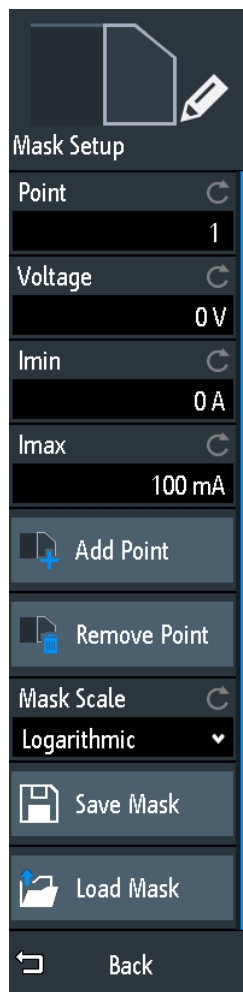
**Point**

Selects the point to be defined.

Voltage

Sets the voltage for the selected point.

Remote command:

[POWER:SOA:LINear:POINT<m>:VOLTage](#) on page 722

[POWER:SOA:LOGarithmic:POINT<m>:VOLTage](#) on page 722

Imin

Sets the minimum current for the selected point.

Remote command:

[POWER:SOA:LINear:POINT<m>:CURRent:MINimum](#) on page 722

[POWER:SOA:LOGarithmic:POINT<m>:CURRent:MINimum](#) on page 722

Imax

Sets the maximum current for the selected point.

Remote command:

`POWer:SOA:LINear:POINT<m>:CURRent` on page 722

`POWer:SOA:LINear:POINT<m>:CURRent:MAXimum` on page 722

`POWer:SOA:LOGarithmic:POINT<m>:CURRent` on page 722

`POWer:SOA:LOGarithmic:POINT<m>:CURRent:MAXimum` on page 722

Add Point

Adds a point to the safe operating area definition list.

Remote command:

`POWer:SOA:LINear:ADD` on page 721

`POWer:SOA:LINear:INSert` on page 721

`POWer:SOA:LOGarithmic:ADD` on page 721

`POWer:SOA:LOGarithmic:INSert` on page 721

Remove Point

Removes the selected point from the safe operating area definition list.

Remote command:

`POWer:SOA:LINear:REMOve` on page 723

`POWer:SOA:LOGarithmic:REMOve` on page 723

Mask Scale

Selects the scale for the mask, linear or logarithmic.

Remote command:

`POWer:SOA:SCALE:MASK` on page 728

Save Mask

Opens a menu to save the mask.

Load Mask

Opens a file explorer to select a previously stored mask. The selected mask is loaded and can be used for a subsequent test.

Test Settings

In this menu you can define the tolerance of the test setup as well as the window scale.

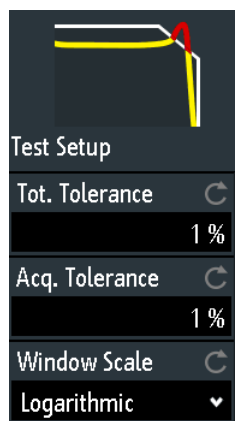

Tot.Tolerance

Sets the allowed total tolerance.

Remote command:

[POWER:SOA:RESult:TOTal:TOLerance](#) on page 726

Acq. Tolerance

Sets the allowed acquisition tolerance.

Remote command:

[POWER:SOA:RESult:ACQuisition:TOLerance](#) on page 724

Windows Scale ← Acq. Tolerance

Selects a linear or a logarithmic scaled for the displayed results.

Remote command:

[POWER:SOA:SCALe:DISPlay](#) on page 728

14 Logic Analyzer (Option R&S RTM-B1, MSO)

The Mixed Signal Option R&S RTM -B1 adds logic analyzer functions to the classical oscilloscope functions. Using the logic analyzer, you can analyze and debug embedded systems with mixed-signal designs that use analog signals and time-correlated digital signals simultaneously. The option provides 16 logic channels grouped in two logic probes (pods) with 8 channels each. The instrument ensures that analog and digital waveforms are time-aligned and synchronized so that critical timing interactions between analog and digital signals can be displayed and tested.

NOTICE

Ensuring accurate measurement results

The logic analyzer option R&S RTM-B1 with connected probe leads is considered as a test probe, according to EN 61326-2-1, clause 5.2.4.101. Therefore, the measurements are sensitive to electromagnetic interference. Consider additional shielding methods to avoid interference.

Consider the following guidelines for good probing practices:

- Attach the ground lead from each pod to the ground of the device under test if any logic channel of the pod is used for data capture. The ground lead improves signal fidelity to the oscilloscope, ensuring accurate measurements.
- For high-speed timing measurements (rise time < 3 ns), use an own ground for each pod.

To activate logic analysis

- ▶ Press the [Logic] key.

14.1 Short Menu for Logic Channels

There are two short menus that show the status of the logic channels, one for the pod "D7...D0" and one for the pod "D15...D8".

- ▶ To open the short menu for logic channels, tap the pod label in the bottom line of the display.
If the pod was not selected, tap twice: once to select the pod, and next to open the short menu.

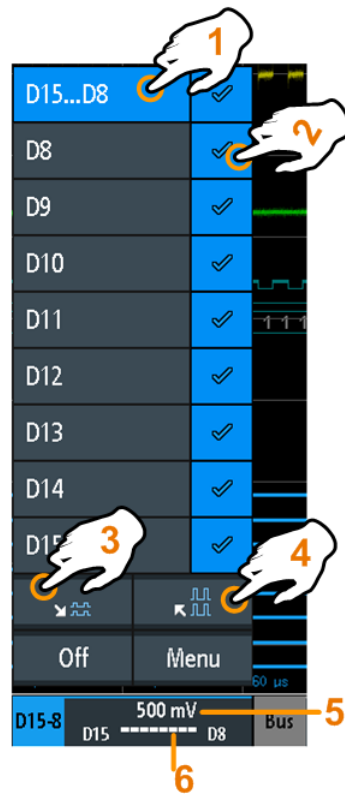

- 1 = selects all/one logic channel
- 2 = displays the logic channel
- 3 = scales all visible channels to a minimum
- 4 = scales all visible channels to a maximum
- 5 = shows the threshold of the channels
- 6 = shows the activity of the logic channel

Logic channels - activity display

The activity symbols of the logic channel show the current status of all logic channels and can have the following values:

- : logic channel is low
- : logic channel is high
- : a change in the state of the logic channel has occurred during the measuring interval

Remote commands:

- [LOGic<p>:PROBe\[:ENABle\]? on page 737](#)
- [DIGital<m>:CURRent:STATe:MINimum? on page 738](#)
- [DIGital<m>:CURRent:STATe:MAXimum? on page 738](#)
- [LOGic<p>:CURRent:STATe:MINimum? on page 738](#)
- [LOGic<p>:CURRent:STATe:MAXimum? on page 738](#)

14.2 Logic Analyzer Settings

Prerequisite: a logic probe is connected to the instrument.

1. If logic analysis is not active, press the [Logic] key to activate it.
2. Press the [Logic] key again.
The "Logic" menu opens.
3. Activate the pod that you want to use, or both pods.
4. Tap "Threshold and Deskew".
5. Set the "Technology", and the "Hysteresis".

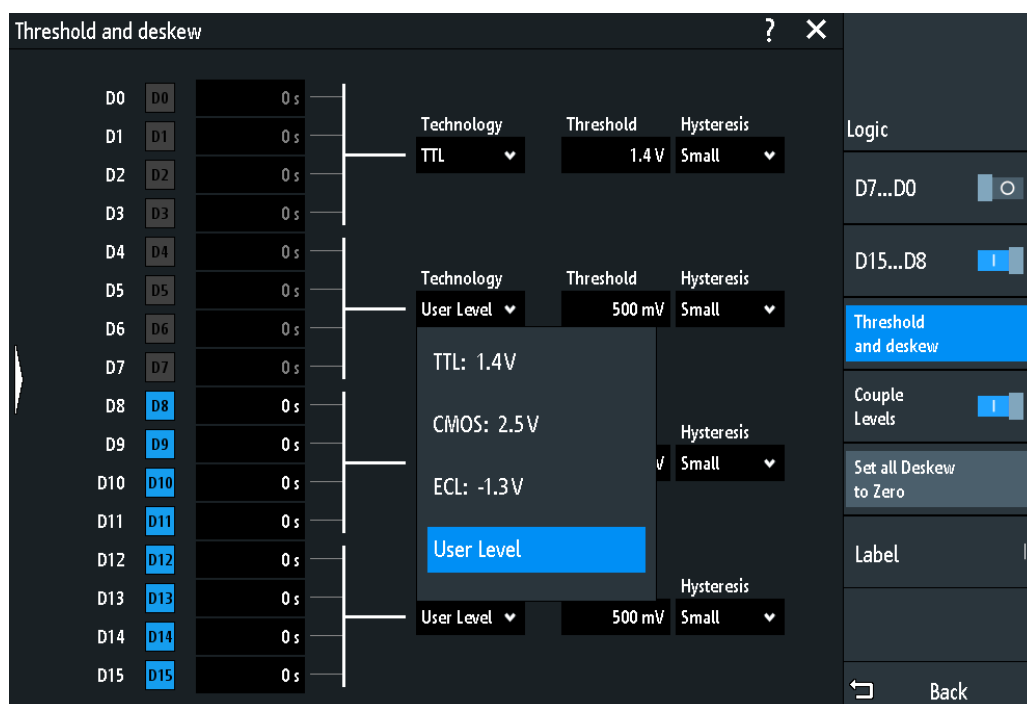

D7...D0 / D15...D8

Switches the selected logic pod on or off.

You can also set the state of each logic channel separately in the short menu, see [Chapter 14, "Logic Analyzer \(Option R&S RTM-B1, MSO\)"](#), on page 372.

Remote command:

`LOGic<p>:STATe` on page 738

Threshold and Deskew

Opens a dialog where you can set the threshold and hysteresises, and the visibility of the individual logic channels.

Couple Levels

Sets all threshold and hysteresis values to the values of the first nibble (D0...D3).

Remote command:

[DIGital<m>:THCoupling](#) on page 739

Set all Deskew to Zero

Aligns the skew between the probe boxes of the digital channels and the probe connectors of the analog channels.

Remote command:

[DIGital<m>:DESKew](#) on page 740

Technology

Selects the threshold level: 3 predefined threshold levels and user-defined threshold are available.

- | | |
|--------------|--|
| "TTL: 1.4V" | Sets the threshold to 1.4 V, which is typically used in transistor–transistor logic (TTL). |
| "CMOS: 2.5V" | Sets the threshold to 2.5 V, which is typically used in complementary metal-oxide–semiconductor technology (CMOS). |
| "ECL: -1.3V" | Sets the threshold to -1.3 V, which is typically used in emitter-coupled logic (ECL). |
| "Threshold" | Selects the user-defined threshold.
Enter the value in Threshold . |

Remote command:

[DIGital<m>:TECHnology](#) on page 739

Threshold

Sets the threshold level value between -2 V and +8 V in steps of 10 mV, or shows the value of the selected technology.

Remote command:

[DIGital<m>:THReshold](#) on page 739

Hysteresis

Defines the size of the hysteresis to avoid the change of signal states due to noise.

Remote command:

[DIGital<m>:HYSTeresis](#) on page 740

Label

Opens a menu to specify user-defined text labels for the individual logic channels.

Bit ← Label

Selects the logic channel or "Bit" for labeling.

- For the pod "D7...D0", you can select bit "D0", "D1", "D2", ... or "D7".
- For the pod "D15...D8", you can select bit "D8", "D9", "D10", ... or "D15".

Label ← Label

Enables or disables the user-defined label for the selected logic channel.

Remote command:

[DIGital<m>:LABel:STATe](#) on page 741

Predefined Label ← Label

Selects a predefined label text. You can edit the text with "Edit Label".

Edit Label ← Label

Opens on-screen keypad to enter a label text. If you previously have selected a predefined label, it is already written in the entry line, and you can modify it.

The maximum name length is 8 characters, and only ASCII characters provided on the on-screen keypad can be used.

Remote command:

[DIGital<m>:LABel](#) on page 741

14.3 Triggering on Logic Channels

Each logic channel can be used as trigger source. Using the pattern trigger, you can trigger on logical combinations of analog and digital channels. Also, you can define a trigger holdoff time.

If you trigger on logic channels, the threshold is used as trigger level.

The following trigger types are available if the trigger source is a logic channel:

- Edge
- Width
- Pattern: the pattern can use all active logic channels
- Timeout

For analysis of serial protocols, you configure the protocol using logic channels as sources, and trigger on trigger type "Serial Bus". For details, see the chapter describing the relevant bus.

14.4 Analyzing Logic Channels

The main analysis tools for logic channels are serial protocol analysis ([Protocol]) and the pattern triggers.

Furthermore, you can display all logic channels and change the vertical scale position. You can also zoom into the display ([Zoom]).

To measure logic channels, you can use automatic and cursor measurements as usual.

See also [Chapter 7.2, "Automatic Measurements"](#), on page 139 and [Chapter 7.3, "Cursor Measurements"](#), on page 148.

You can also export the waveform data: [Save Load] key > "Waveforms"

14.5 Parallel Buses

The R&S RTM3000 can display and decode up to 16 lines of a parallel bus. You can assign the logic channels to the bus bits individually.

To trigger on parallel buses, use the pattern trigger, see [Chapter 5.8, "Pattern Trigger"](#), on page 84.

- [Parallel Bus Configuration](#).....377
- [Decode Results](#).....379

14.5.1 Parallel Bus Configuration

You can configure a parallel bus or a parallel clocked bus. For the parallel clocked bus, a clock line and an optional chip select line are defined in addition to the other settings.

Access: [Protocol] > "Bus Type" = "Parallel" / "Parallel Clocked" > "Configuration"

The following configuration menu opens:

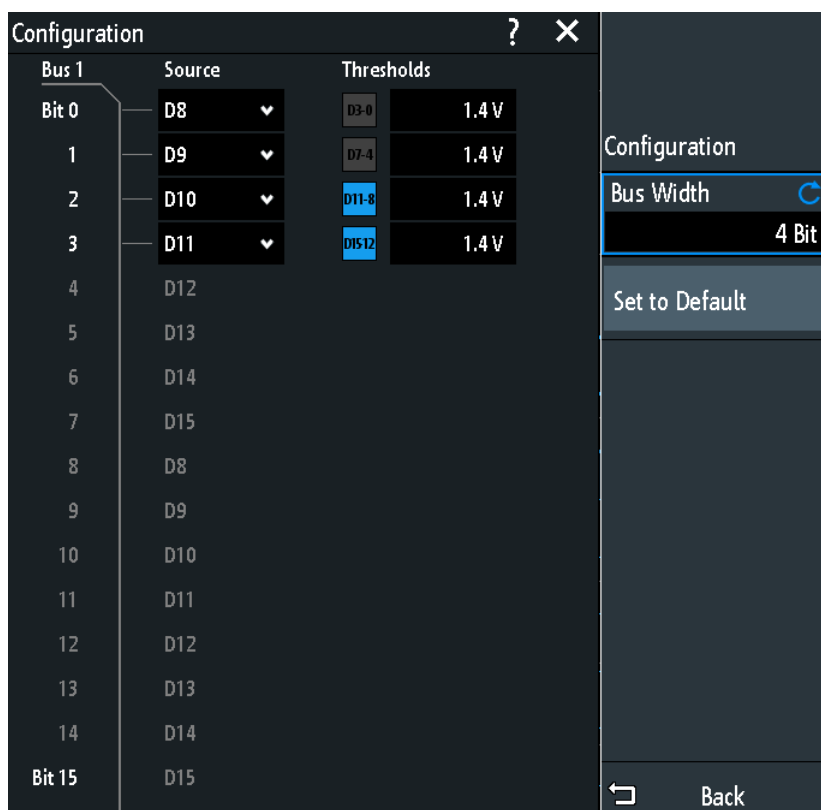

Figure 14-1: Configuration menu Parallel bus

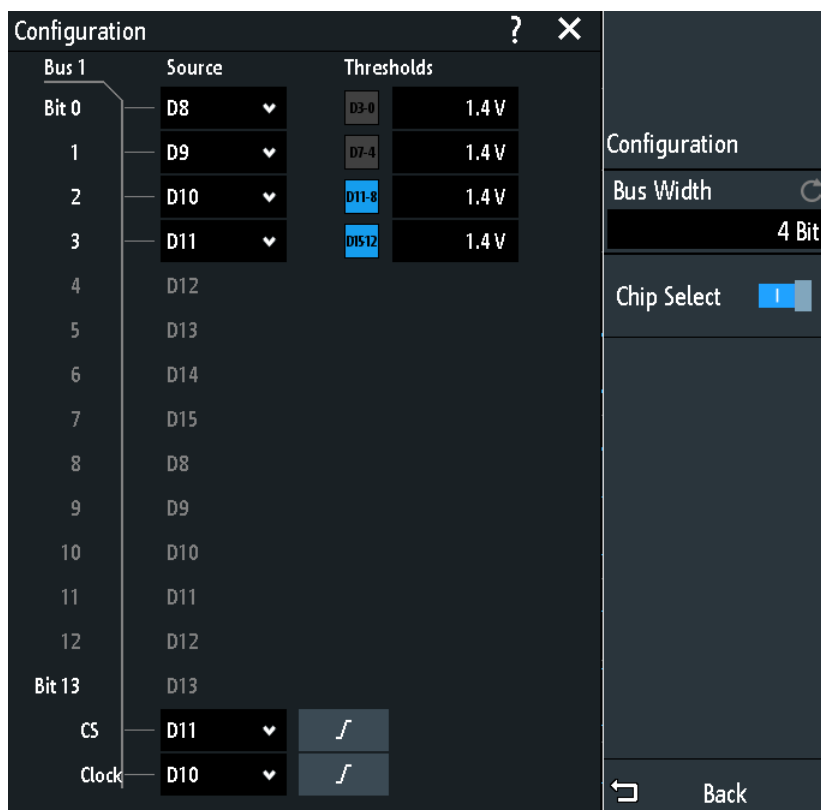

Figure 14-2: Configuration menu Parallel clocked bus

The menus offer the following settings:

Bus Width.....	378
Thresholds.....	378
Source.....	379
Set to Default.....	379
Chip Select.....	379
Polarity.....	379
Slope.....	379

Bus Width

Sets the number of lines (bits) of the logic channels D0 to D15 to be analyzed in the parallel or clocked parallel bus. The maximum number is the number of logic input lines.

Remote command:

- BUS:PARAllel:WIDTh on page 744
- BUS:CPARAllel:WIDTh on page 744

Thresholds

Set the threshold for each nibble of logic channels: D0...D3, D4...D7, D8...D11, and D12...D15.

The setting is also available in the "Logic" configuration.

Remote command:

[DIGital<m>:THReshold](#) on page 739

Source

Selects the input line for each bit of the parallel or clocked parallel bus.

If you use a clocked parallel bus, in the last two lines you can select the source for the "Clock" and "CS".

Remote command:

[BUS:PARAllel:DATA<m>:SOURce](#) on page 744

[BUS:CPARAllel:DATA<m>:SOURce](#) on page 744

[BUS:CPARAllel:CLOCK:SOURce](#) on page 745

[BUS:CPARAllel:CS:SOURce](#) on page 746

Set to Default

Resets the data lines of the parallel bus to the default order D0...D15.



Chip Select

Enables the chip select line for the parallel clocked bus.

Remote command:

[BUS:CPARAllel:CS:ENABle](#) on page 745



Polarity

For the parallel clocked bus, selects if the chip select signal is high active ( high = 1) or low active ( low = 1).

Remote command:

[BUS:CPARAllel:CS:POLarity](#) on page 746

Slope

For the parallel clocked bus, selects if the data is sampled on the rising () or falling () slope of the clock, or on both edges () of a double data rate clock. The clock slope marks the begin of a new bit.

Remote command:

[BUS:CPARAllel:CLOCK:SLOPe](#) on page 745

14.5.2 Decode Results

When the configuration of the parallel bus is complete, the signal can be decoded:

1. In the "Bus" menu, enable "Decode".
2. In the "Display" menu, select the result display settings.
See [Chapter 12.1.2, "Displaying Decode Results"](#), on page 233.
3. In the "Bus Table" menu, enable the "Bus Table". Adjust the table settings.
See also: [Chapter 12.1.3, "Bus Table: Decode Results"](#), on page 234

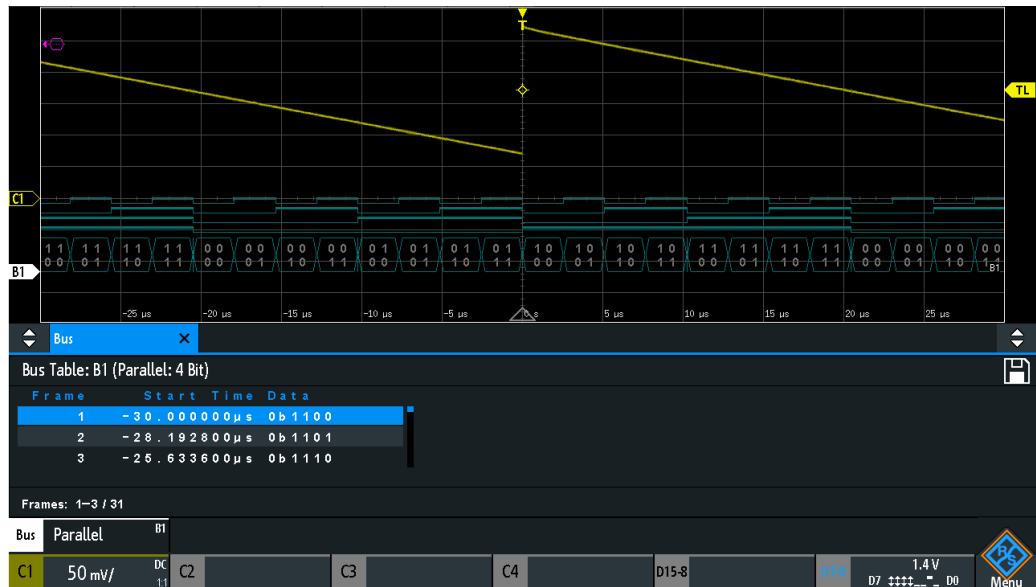

Figure 14-3: Decoded Parallel bus signal with bus table

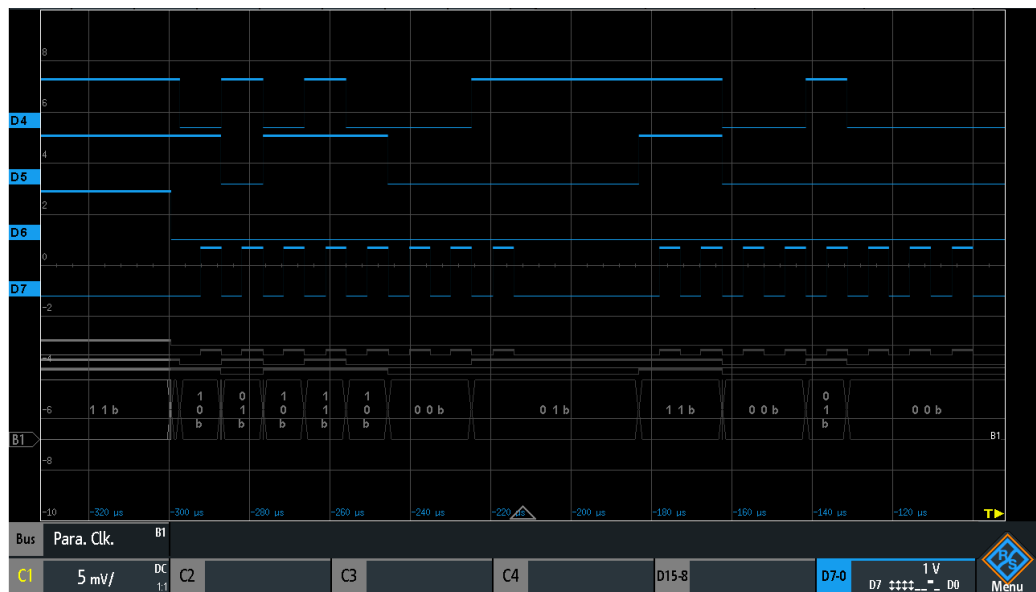

Figure 14-4: Decoded Parallel clocked bus signal

The bus table shows the data of decoded frames and the corresponding start time. Remote commands are described in [Chapter 16.13.2.3, "Parallel Buses - Decode Results"](#), on page 746.

15 Signal Generation (Option R&S RTM-B6)

The R&S RTM3000 has an integrated function and pattern generator which can generate signals while testing circuits, for instance.

The waveform generator can output simple functions, modulated sine waveform, arbitrary waveforms and sweep waveforms. The integrated pattern generator can generate individual or cycle patterns and simple bus signal patterns.

15.1 Function Generator

The waveform generator can output simple functions, modulated sine waveform, arbitrary waveforms and sweep waveforms. The signal is output at the [Aux Out] connector on the front panel.

Short Menu

In the short menu for the function generator, you can open the comprehensive menu, and turn off the function generator.

You can also create an arbitrary waveform by copying a waveform and display or hide the arbitrary waveform. For description of the functions in the short menu, see [Chapter 15.1.6, "Arbitrary Setup Settings"](#), on page 391.

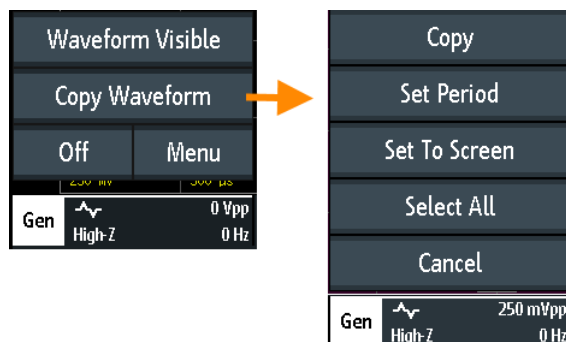

Figure 15-1: Short menu to create arbitrary waveform

15.1.1 Using the Function Generator

To configure a function waveform

1. Press the [Gen] key on the front panel.
2. Select the "Function" that you want to generate, e.g. "Sine".
3. Depending on the selected "Function", configure the settings of the waveform like "Frequency" and "Amplitude".

4. Activate "Output", to output the waveform at the [Aux Out] connector at the front panel.

To generate a modulated waveform

Modulation settings are described in [Chapter 15.1.4, "Modulation Settings"](#), on page 388.

1. Press the [Gen] key on the front panel.
2. Configure the carrier waveform as described above.
3. Tap "Modulation".
4. In the "Modulation" menu, tap "Modulation Type" and select the modulation type, e.g. "AM".
5. Depending on the selected "Modulation Type", configure the settings of the waveform.
6. Enable "Modulation" to activate the modulation.
7. Tap "Back".
8. Activate "Output", to output the waveform at the [Aux Out] connector at the front panel.

To generate an arbitrary waveform using the comprehensive menu

Settings are described in [Chapter 15.1.6, "Arbitrary Setup Settings"](#), on page 391.

1. Capture and display the waveform that is the basis for the arbitrary waveform.
2. Press the [Gen] key on the front panel.
3. Select "Function" > "Arbitrary".
4. Set the frequency, amplitude, and offset of the waveform to be generated.
5. Tap "Arbitrary Setup".
6. Select the "Source" waveform.
7. To select a sector of the existing waveform, tap "Cut Waveform". Do one of the following:
 - a) Set the "Start" and "Stop" time to select an area.
 - b) Drag the limit lines of the area to change the start and stop time.
 - c) Tap "Set Period" to set the copy to the first period of the waveform.
 - d) Tap "Set To Screen", to set the copy area within the screen around the trigger point.
 - e) Tap "Select All" to use the complete waveform.
8. Press "Copy" to create the arbitrary waveform from the selected "Source" and the "Cut Waveform" limits.

The arbitrary waveform is automatically saved.

9. Tap "Visible" to enable the arbitrary waveform.
The arbitrary waveform is shown in magenta color. If the arbitrary waveform was created from a part of the displayed channel waveform, this part is stretched in horizontal direction to fill all divisions.
10. To load an existing arbitrary waveform or a saved reference waveform, tap "Load". Select the waveform file.
11. Tap "Back".
12. Activate "Output", to output the waveform at the [Aux Out] connector at the front panel.
The created arbitrary waveform is output at the [Aux Out] connector at the front panel, with the frequency, amplitude and offset that are set in the "Function Generator" menu.

To generate an arbitrary waveform using the short menu

Settings are described in [Chapter 15.1.6, "Arbitrary Setup Settings"](#), on page 391.

1. Capture and display the waveform that is the basis for the arbitrary waveform.
2. Press the [Gen] key on the front panel.
3. Select "Function" > "Arbitrary".
4. Set the frequency, amplitude, and offset of the waveform to be generated.
5. Activate "Output".
6. Open the short menu of the function generator in the bottom menu.
7. Tap "Copy Waveform".
8. To select a sector of the existing waveform, tap "Cut Waveform". Do one of the following:
 - a) Drag the limit lines of the area to change the start and stop time.
A time edit field is shown, where you also can set the "Start" and "Stop" time.
 - b) Tap "Set Period" to set the copy to the first period of the waveform.
 - c) Tap "Set To Screen", to set the copy area within the screen around the trigger point.
 - d) Tap "Select All" to use the complete waveform.
9. Press "Copy" to create the arbitrary waveform the "Cut Waveform" limits.
The arbitrary waveform is shown in magenta color. If the arbitrary waveform was created from a part of the displayed channel waveform, this part is stretched in horizontal direction to fill all divisions. The arbitrary waveform is automatically saved. The created arbitrary waveform is output at the [Aux Out] connector at the front panel, with the frequency, amplitude and offset that are set in the "Function Generator" menu.

To configure a burst

Burst settings are described in [Chapter 15.1.5, "Burst Settings"](#), on page 390.

1. Press the [Gen] key on the front panel.
2. Configure the signal waveform as described above.
3. Select the "Burst" tab.
4. Set the "N-Cycle", the "Idle Time" and the "Start Phase".
5. Set the "Trigger" to "Cont." or "Manual".
6. Tap "Back".
7. Activate "Output", to output the waveform at the [Aux Out] connector at the front panel.

To configure a sweep waveform

Weep settings are described in [Chapter 15.1.3, "Sweep Settings"](#), on page 387.

1. Press the [Gen] key on the front panel.
2. Configure the signal waveform as described above.
3. Select the "Sweep" tab.
4. Set the "Start Frequency", the "Stop Frequency" and the "Sweep Time".
5. Press "Sweep" to enable the sweep.
6. Tap "Back".
7. Activate "Output", to output the waveform at the [Aux Out] connector at the front panel.

15.1.2 Basic Settings of the Function Generator

Access: [Gen] key

For a step-by-step description, see ["To configure a function waveform"](#) on page 381.

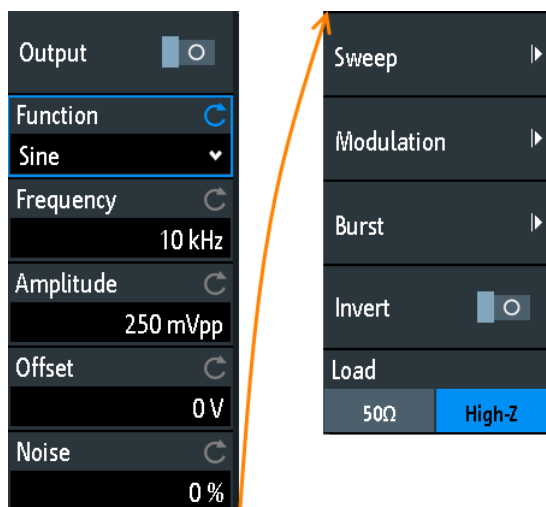

Output

Enables the function generator.

Remote command:

[WGEnerator:OUTPut\[:ENABle\]](#) on page 751

Function

Selects the type of waveform to be generated. For all waveforms, you can set the [Frequency](#), [Amplitude](#), [Offset](#), and [Noise](#).

"DC"	Generates a direct current (DC) signal.
"Sine"	Generates a sine wave.
"SinC"	Generates a cardinal sine wave.
"Rectangle"	Generates a square wave.
"Pulse"	Generates a pulse signal. Additional settings are the Duty Cycle and the Edge Time .
"Triangle"	Generates a triangle signal.
"Ramp"	Generates a ramp signal. You can set the Polarity .
"Arbitrary"	Generates an arbitrary waveform, which is copied from an existing waveform, or loaded from file. See Chapter 15.1.6, "Arbitrary Setup Settings" , on page 391.
"Exponential"	Generates an exponential rise signal. You can set the Polarity .

Remote command:

[WGEnerator:FUNCTion](#) on page 749

Frequency

Sets the frequency of the waveform. The available frequency range depends on the selected function. The frequency ranges are provided the datasheet.

Remote command:

[WGEnerator:FREQUency](#) on page 749

Amplitude

Sets the amplitude of the waveform.

Remote command:

[WGENerator:VOLTage](#) on page 749

Offset

Sets the vertical offset of the generated waveform.

Remote command:

[WGENerator:VOLTage:OFFSet](#) on page 749

Noise

Sets the noise of the generated waveform.

Remote command:

[WGENerator:NOISe:ABSolute](#) on page 750

[WGENerator:NOISe:RELative](#) on page 750

Polarity

Sets the polarity for ramp and exponential functions.

For the "Exponential" function, you can choose between a rising or falling exponential. For the "Ramp" function, you can set a positive or negative polarity.

Remote command:

[WGENerator:FUNCTion:EXPonential:POLarity](#) on page 750

[WGENerator:FUNCTion:RAMP:POLarity](#) on page 750

Edge Time

Sets the pulse edge time.

Remote command:

[WGENerator:FUNCTion:PULSe:ETIME](#) on page 750

Duty Cycle

Sets the duty cycle for the pulse function. The duty cycle expresses for what percentage of the period, the signal state is high.

Remote command:

[WGENerator:FUNCTion:PULSe:DCYCLE](#) on page 749

Symmetry

Sets the symmetry for the triangle waveform. 50% defines symmetric triangles. Values <50% define triangles with steeper rising edge leaned to the left. Values >50% define triangles with steeper falling edge leaned to the right.

Remote command:

[WGENerator:TRIangle:SYMMetry](#) on page 750

Arbitrary Setup

Opens a menu to configure the arbitrary waveform.

See [Chapter 15.1.6, "Arbitrary Setup Settings"](#), on page 391.

Sweep

Opens a menu to configure the sweep.

See [Chapter 15.1.3, "Sweep Settings"](#), on page 387.

Modulation

Opens a menu to configure the modulation.

See [Chapter 15.1.4, "Modulation Settings"](#), on page 388.

Invert

Inverts the waveform at the offset level.

Load

Select the user load, the load of the DUT at its connection. You can select either a "50Ω" or a "High-Z" (high input impedance) load.

Remote command:

[WGNErator:OUTPut:LOAD](#) on page 751

15.1.3 Sweep Settings

Access: [Gen] key > "Sweep"

In the sweep mode, the R&S RTM3000 generates a signal whose frequency gradually changes from the [Start Frequency](#) to the [Stop Frequency](#) for a certain [Sweep Time](#).

For a step-by-step description of the sweep setup, see ["To configure a sweep waveform"](#) on page 384.

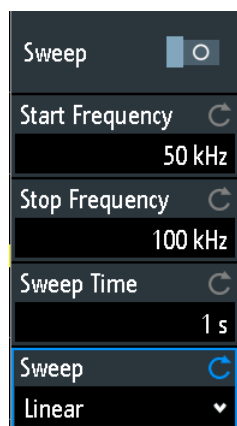
**Sweep**

Enables or disables the sweeping.

Remote command:

[WGNErator:SWEEp\[:ENABLe\]](#) on page 756

Start Frequency

Sets the start frequency of the sweep signal.

Remote command:

[WGENerator:SWEep:FStart](#) on page 756

Stop Frequency

Sets the stop frequency of the sweep signal.

Remote command:

[WGENerator:SWEep:FEND](#) on page 756

Sweep Time

Sets the duration of the sweep.

Remote command:

[WGENerator:SWEep:TIME](#) on page 756

Sweep

Sets the type of the sweep, a linear, logarithmic or triangle-shaped change of the frequency. The triangle-shaped sweep will run from the "Start Frequency" to the "Stop Frequency" and then from the "Stop Frequency" back to the "Start Frequency".

Remote command:

[WGENerator:SWEep:TYPE](#) on page 756

15.1.4 Modulation Settings

Access: [Gen] key > "Modulation"

Modulation is the variation of properties of an original periodic waveform according to a second modulating signal. The type of modulation determines which properties are changed.

For a step-by-step description of the modulation setup, see "[To generate a modulated waveform](#)" on page 382.



Modulation

Enables or disables modulation.

Remote command:

[WGENerator:MODulation\[:ENABLE\]](#) on page 753

Modulation Type

Selects the modulation type, which defines how the carrier signal is modified.

"AM"	Amplitude modulation. The amplitude of the carrier signal is varied according to the modulation signal.
"FM"	Frequency modulation. The frequency of the carrier signal is varied according to the modulation signal.
"ASK"	Amplitude shift keying (ASK) modulation. The amplitude switches between 100% and the "ASK Depth" amplitude with a defined modulating "Frequency".
"FSK"	Frequency shift keying (FSK) modulation. The signal frequency switches between the carrier "Frequency" and the "Hop. Frequency" at a "FSK Rate".

Remote command:

[WGENerator:MODulation:TYPE](#) on page 754

Function

Selects the type of the modulating signal for AM or FM modulation.

Remote command:

[WGENerator:MODulation:FUNCTion](#) on page 753

Frequency

Sets the frequency of the modulating waveform for AM/FM/ASK modulation.

Remote command:

[WGENerator:MODulation:AM:FREQuency](#) on page 754

[WGENerator:MODulation:FM:FREQuency](#) on page 754

[WGENerator:MODulation:ASK:FREQuency](#) on page 755

AM Depth

Sets the modulation depth, the percentage of the amplitude range that is used for AM modulation.

Remote command:

[WGENerator:MODulation:AM:DEPTH](#) on page 754

Deviation

Sets the frequency deviation, the maximum difference between the FM modulated signal and the carrier signal.

Remote command:

[WGENerator:MODulation:FM:DEVIation](#) on page 755

ASK Depth

Sets the modulation depth, the percentage of the amplitude range that is used for ASK modulation.

Remote command:

[WGEnerator:MODulation:ASK:DEPT_h](#) on page 755

Polarity

Sets the polarity of the ramp function for AM and FM modulation.

Remote command:

[WGEnerator:MODulation:RAMP:POLarity](#) on page 755

Hop. Frequency

Sets the second frequency of the FSK-modulated signal.

Remote command:

[WGEnerator:MODulation:FSK:HFREquency](#) on page 755

FSK Rate

Sets the rate at which signal switches between the carrier frequency and the hopping frequency.

Remote command:

[WGEnerator:MODulation:FSK:RATE](#) on page 755

15.1.5 Burst Settings

Access: [Gen] key > "Burst"

With the burst mode, you can output a waveform for a set number of times.

For a step-by-step description of the modulation setup, see "[To configure a burst](#)" on page 384.

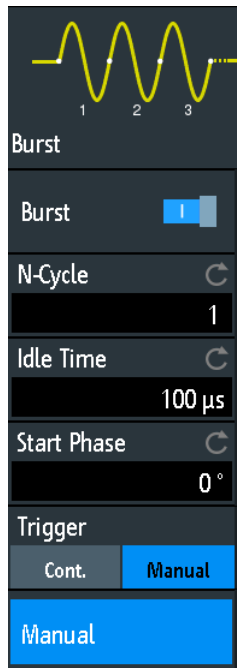

Burst

Enables or disables the burst.

Remote command:

[WGENerator:BURSt\[:STATe\]](#) on page 753

N-Cycle

Sets the number of times the generator outputs one cycle of the waveform per burst.

Remote command:

[WGENerator:BURSt:NCYCLe](#) on page 752

Idle Time

Sets the idle time between two burst cycles.

Remote command:

[WGENerator:BURSt:ITIMe](#) on page 752

Start Phase

Sets the start phase of the burst.

Remote command:

[WGENerator:BURSt:PHASe](#) on page 753

Trigger

Selects the trigger mode. Each time the generator receives a trigger, it outputs a burst with the number of cycles defined with "N-Cycle".

In the continuous mode, the oscilloscope outputs continuously when the burst is enabled.

In the manual mode, you have to press "Manual" to output a burst.

15.1.6 Arbitrary Setup Settings

Access: [Gen] key > "Arbitrary Setup"

An arbitrary waveform is copied from an existing waveform on the instrument, or loaded from file. You can display the arbitrary waveform on the screen.

For a step-by-step description of the modulation setup, see "[To generate an arbitrary waveform using the comprehensive menu](#)" on page 382.

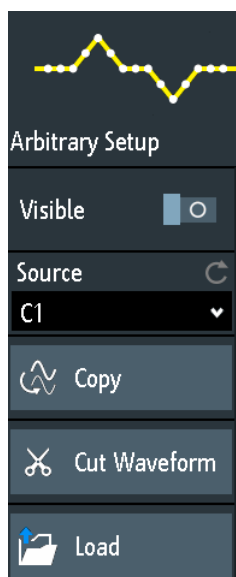
**Visible**

Enables the display of the arbitrary waveform.

Remote command:

[WGEnerator:ARbitrary:VISible](#) on page 752

Source

Selects the source of the arbitrary waveform. You can load an existing file or load the current oscilloscope waveform.

Remote command:

[WGEnerator:ARbitrary:SOURce](#) on page 751

Copy

Loads the waveform from the selected "Signal source" or the waveform part selected with "Cut Waveform".

Remote command:

[WGEnerator:ARbitrary:UPDate](#) on page 752

Cut Waveform

Provides the settings to refine the part of the waveform to be copied.

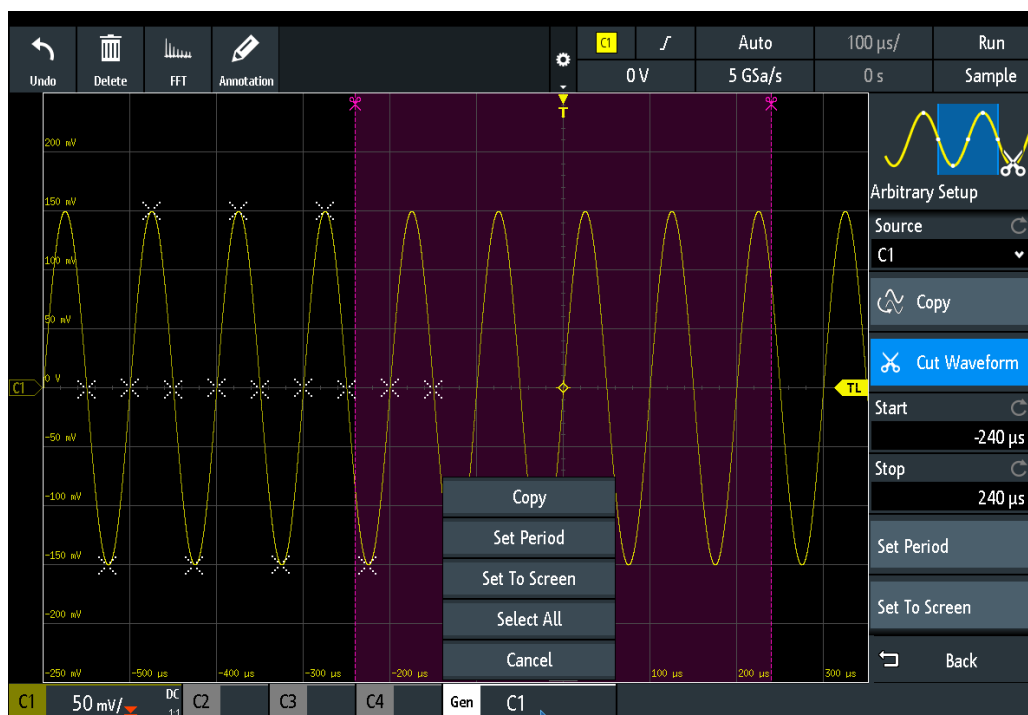
**Set Period ← Cut Waveform**

Sets the copy area to the first period of the waveform.

Set To Screen ← Cut Waveform

Sets the copy area within the screen.

Select All ← Cut Waveform

Selects the whole waveform.

Start ← Cut Waveform

Sets the start time of the copy area.

Remote command:

[WGGenerator:ARbitrary:RANGE:START](#) on page 751

Stop ← Cut Waveform

Sets the stop time of the copy area.

Remote command:

[WGGenerator:ARbitrary:RANGE:STOP](#) on page 751

Load

Opens a file selection dialog box and loads the selected file. The instrument supports .trf and .csv file formats, the same formats like for reference waveforms.

Remote command:

[WGGenerator:ARbitrary\[:FILE\]:NAME](#) on page 752

[WGGenerator:ARbitrary\[:FILE\]:OPEN](#) on page 752

15.2 Pattern Generator

The pattern generator outputs parallel patterns on the four pins P0 to P3 on the front panel of the instrument.

1. Press the  [Apps Selection] key.
2. Tap "Pattern Gen."

A dialog box shows the pins, on which the pattern is output, depending on the selected pattern.

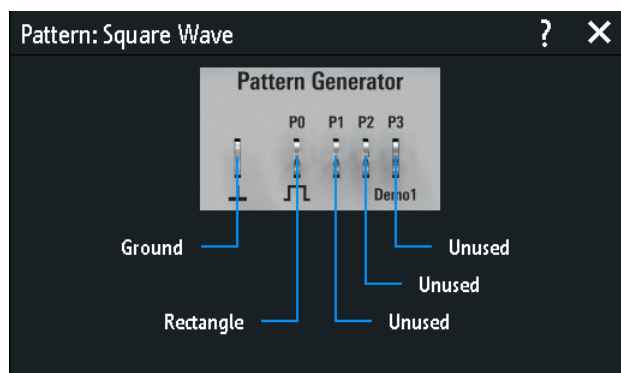

15.2.1 Pattern Selection

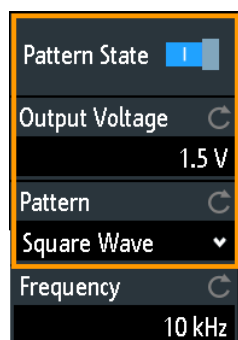

Pattern State

Enables or disables the pattern output at the pins P0 to P3.

Remote command:

[PGenerator: PATtern: STATe](#) on page 758

Output Voltage

Sets the output voltage of the generated pattern signal.

Pattern

Selects the pattern type.

"Square Wave" Generates a square wave pattern at pin P0.

"Counter"	Generates a 4-bit wide counter pattern at pins P0 to P3.
"Arbitrary"	Creates, saves or loads an arbitrary 4-bit wide pattern and outputs it at pins P0 to P3.
"Manual"	Sets the high or low state for each pin.
"UART, SPI, I2C, CAN, LIN, Audio-I2S, Audio-TDM"	Generate a bus signal for measurements without measurement object.
"PWM, PWM - RGB LED, PWM-TestSignals"	Generate various pulse width modulated signals.

Remote command:

[PGENerator:FUNction](#) on page 757

15.2.2 Settings for Square Wave Pattern

Access:  "Menu" > "Pattern Gen." > "Pattern" = "Square Wave"

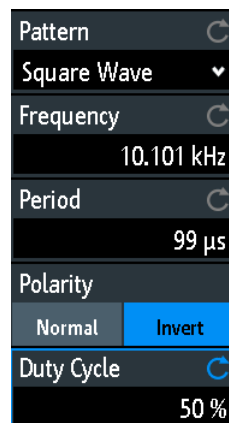

Frequency

Sets the frequency of the square wave.

The values of the "Frequency" and "Period" depend on each other, as:

$$Period = 1 / Frequency$$

If you change the value, the "Period" is adjusted accordingly.

Remote command:

[PGENerator:PATtern:FREQuency](#) on page 759

Period

Sets the period of the square wave. If you change the value, the "Frequency" is adjusted accordingly.

Remote command:

[PGENerator:PATtern:PERiod](#) on page 759

Polarity

Sets normal or inverted polarity.

Remote command:

[PGENerator: PATTern: SQUarewave: POLarity](#) on page 758

Duty Cycle

Sets the duty cycle of the square wave from 1% to 99%. The duty cycle expresses for what percentage of the period, the signal state is high.

Remote command:

[PGENerator: PATTern: SQUarewave: DCYCLE](#) on page 758

15.2.3 Settings for Counter Pattern

Access:  "Menu" > "Pattern Gen." > "Pattern" = "Counter"

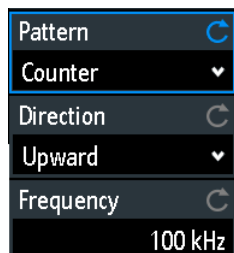

Frequency

Sets the switching frequency, how fast the pattern condition changes. The square waveforms at the pins have the following resulting frequencies:

- P0: $f/2$
- P1: $f/4$
- P2: $f/8$
- P3: $f/16$

Remote command:

[PGENerator: PATTern: COUNter: FREQUENCY](#) on page 759

Direction

Changes the counting direction.

Remote command:

[PGENerator: PATTern: COUNter: DIRection](#) on page 759

15.2.4 Settings for Arbitrary Pattern

Access:  "Menu" > "Pattern Gen." > "Pattern" = "Arbitrary"

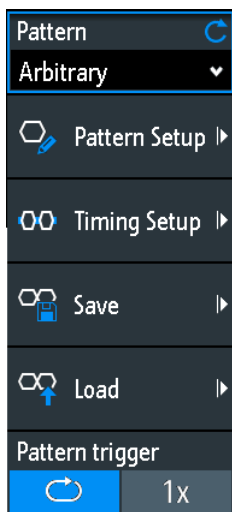

- [General Settings](#)..... 397
- [Pattern Setup](#)..... 398
- [Timing Setup](#)..... 399

15.2.4.1 General Settings

Pattern Setup

Opens the menu to define the individual bit values of the pattern.

See [Chapter 15.2.4.2, "Pattern Setup"](#), on page 398.

Timing Setup

Opens the menu to define the timing parameters.

See [Chapter 15.2.4.3, "Timing Setup"](#), on page 399.

Save

Opens a dialog box to save a waveform as an ARB pattern. The text files containing remote commands are saved in *.scp format.

You can select the "Location" to which the waveform file (internal or USB) is saved.

Tap "Save" to save the file under the current name.

Tap "New File" and enter the name of the new file you want to save.

You can also delete obsolete files in the dialog box.

Load

Provides functions to load an ARB waveform.

Select the "Location" of the waveform file (internal or USB), and the file. Tap "Load".

You can also delete obsolete files in the dialog box.

Pattern trigger

Selects the mode for the trigger for the ARB signal or PWM test signal. You can select an automatic continuous trigger or a manual one time trigger. If "1x" is selected, tap "Manual" to initiate the trigger.

Remote command:

[PGenerator: PATtern: TRIGger: MODE](#) on page 760

[PGenerator: PATtern: TRIGger: SINGLE](#) on page 761

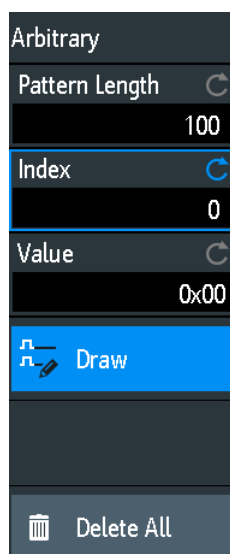
15.2.4.2 Pattern Setup**Pattern Length**

Sets the pattern length, the number of samples for the pattern.

Remote command:

[PGenerator: PATtern: ARBitrary: DATA: LENGTH](#) on page 760

Index

Selects a sample. The selected sample is shown in the information box as a light blue line. Around the index, ± 8 bits are displayed.

Remote command:

[PGenerator: PATtern: ARBitrary: DATA: APPend: INDEX](#) on page 761

Value

Sets the value of the currently selected "Index".

Draw

If enabled, you can draw large sample amounts with the same value.

Delete All

Deletes the pattern. Also, resets the "Pattern Length" to 1 and the "Value" to 0.

15.2.4.3 Timing Setup

Access:  "Menu" > "Pattern Gen." > "Pattern" = "Arbitrary" or "PWM-TestSignals"

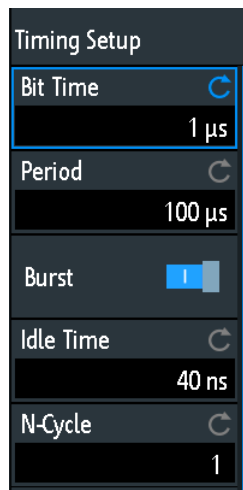

Bit Time

Sets the time at which each sample is applied. The time is identical for all samples.

Remote command:

[PGenerator:PATtern:STIME](#) on page 761

Period

Sets the period of the sample. It applies to the whole pattern. $\text{Period} = \text{Pattern Length} * \text{Bit Time}$

Remote command:

[PGenerator:PATtern:PERiod](#) on page 759

Burst

If activated, the instrument pauses after each issued pattern for the duration of the "Idle Time".

Remote command:

[PGenerator:PATtern:BURSt:STATe](#) on page 762

Idle Time

Sets the idle time, the time for which the instrument pauses after each issued pattern. The "Idle Time" between the patterns can be set from 20 ns to 42 s in increments of 10 ns.

Remote command:

[PGenerator:PATtern:ITIME](#) on page 761

N-Cycle

Sets the number of times the pattern is generated.

Remote command:

[PGenerator:PATtern:BURSt:NCYCLe](#) on page 762

15.2.5 Settings for Manual Pattern

Access:  "Menu" > "Pattern Gen." > "Pattern" = "Manual"

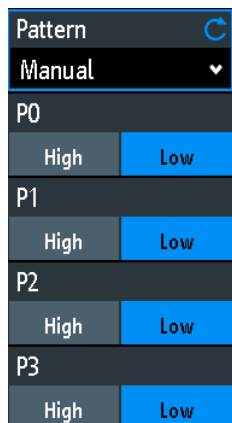

P0/P1/P2/P3

Sets the states to high or low for the respective pin of the manual pattern.

Remote command:

[PGenerator:MANual:STATe<s>](#) on page 762

15.2.6 Settings for Serial Buses

You can use the pattern generator to generate signals according to serial protocols (bus signals).

The generated serial protocol signals are pseudo random pattern and are not adaptable. Only the protocol type and the data rate can be selected.

The contact at the upper left is always ground and the signal levels are about 1 V. The following table shows how the four outputs P0, P1, P2 and P3 are used, depending on the signal.

Signal	P0	P1	P2	P3
UART	Tx	Rx	Unused	Unused
SPI	Clock	Mosi	Miso	Chip Select
I2C	Clock SCL	Data SDA	Unused	Unused
CAN	CAN H	CAN L	Unused	Unused
LIN	High	Low	Unused	Unused

Access:  "Menu" > "Pattern Gen." > "Pattern" = "UART | SPI | I2C | CAN | LIN"

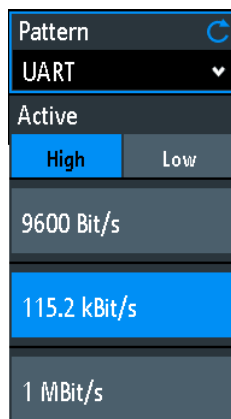

Data Rate

Select the data rate of the bus signal.

The following values are available for the specific bus:

- **UART:** 9600 Bit/s, 115.2 kBit/s, 1 MBit/s
- **SPI:** 100 kBit/s, 250 kBit/s, 1 MBit/s
- **I2C:** 100 kBit/s, 400 kBit/s, 1000 kBit/s, 3400 kBit/s
- **CAN:** 50 kBit/s, 100 kBit/s, 1 MBit/s
- **LIN:** 9.6 kBit/s, 10.417 kBit/s, 19.200 kBit/s

Active

Sets the polarity for the UART bus.

15.2.7 Settings for PWM Signals

You can use the pattern generator to generate several pulse width modulated (PWM) signals: PWM, PWM - RGB LED, PWM-TestSignals.

- [PWM signals](#)..... 401
- [PWM - RGB LED Signals](#).....402
- [PWM Test Signals](#)..... 403

15.2.7.1 PWM signals

Access: ♦ "Menu" > "Pattern Gen." > "Pattern" = "PWM"

You can use the generated signal to control a motor driver directly, for example.

Frequency

Sets the frequency of the PWM signal.

Remote command:

[PGenerator: PATtern: FREquency](#) on page 759

Duty Cycle

Sets the duty cycle of the PWM signal at P0. Change the duty cycle using the Navigation knob to increase or decrease the motor speed.

Remote command:

[PGENerator: PATTern: PWM: DCYClE](#) on page 763

Direction

Changes the direction of motor rotation.

Remote command:

[PGENerator: PATTern: PWM: DIRection](#) on page 763

Enable

Switches the motor on or off if the motor driver uses a dedicated enable signal.

Remote command:

[PGENerator: PATTern: PWM: ENABle](#) on page 763

15.2.7.2 PWM - RGB LED Signals

Access:  "Menu" > "Pattern Gen." > "Pattern" = "PWM - RGB-LED"

Using the pattern "PWM - RGB LED Signals", you can generate signals to control, for example, the colors of LED strip lights.

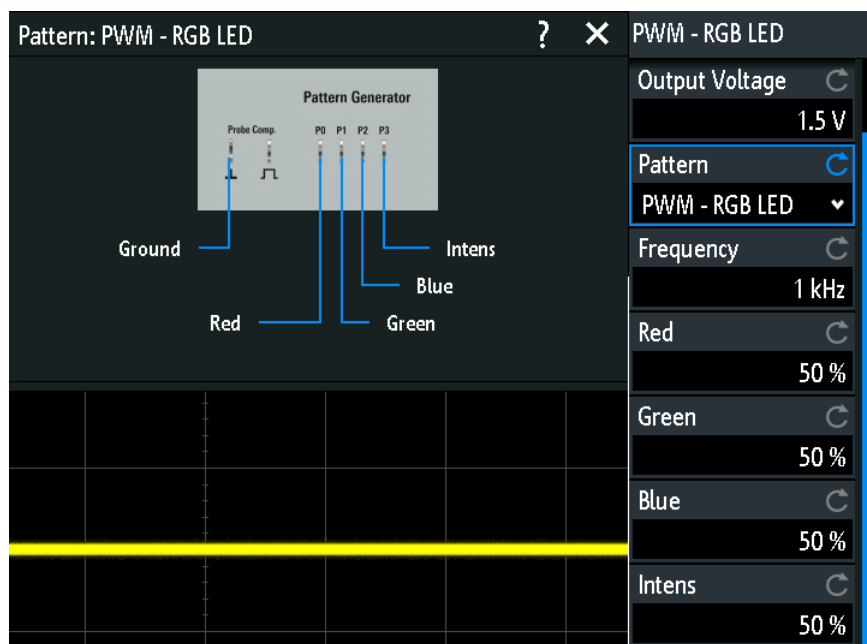

Red, Green, Blue

Set the duty cycle of the red, green, and blue colors, which corresponds to the color intensity.

Remote command:

[PGENerator: PATTern: LED: RED](#) on page 763

[PGENerator: PATTern: LED: GREEn](#) on page 763

[PGENerator: PATTern: LED: BLUE](#) on page 763

Intens

Sets the duty cycle of the signal at P3, which corresponds to the intensity of the light. You can use this signal if the controller supports separate intensity control.

Remote command:

`PGenerator:Pattern:LED:INTens` on page 763

15.2.7.3 PWM Test Signals

Access:  "Menu" > "Pattern Gen." > "Pattern" = "PWM-TestSignals"

Using the pattern "PWM_TestSignals", you can generate several test signals:

- P0 ("Ramp"): saw-tooth modulated PWM signal
- P1 ("Sine"): sine modulated PWM signal
- P2 ("Sync. Pulse"): can be used for trigger
- P3 ("Sync. Pulse - Cycle"): can be used for trigger

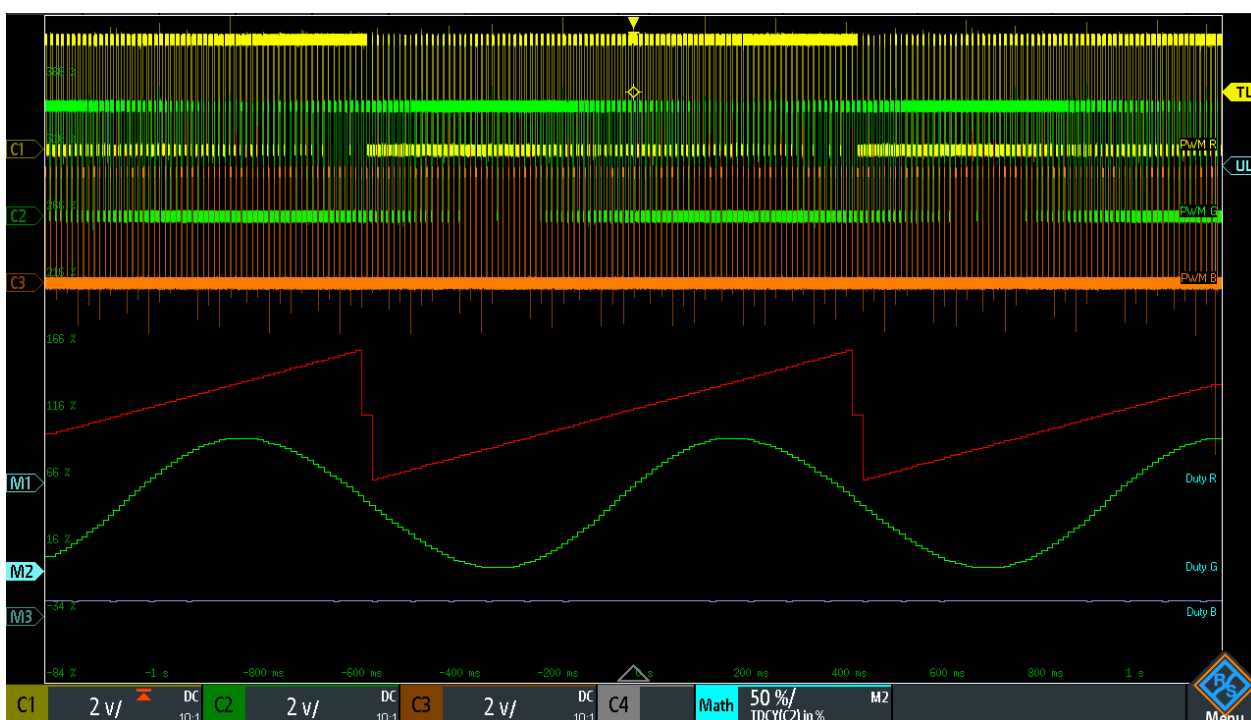

Figure 15-2: PWM test signals used for RGB LED control: P0 connected to C1, P1 to C2, and P2 to C3

- ▶ To configure the generated signal, you set:
 - a) "Output Voltage", see "Output Voltage" on page 394
 - b) "Frequency", see "Frequency" on page 395
 - c) Period, bit time and burst, see Chapter 15.2.4.3, "Timing Setup", on page 399
 - d) Pattern trigger, see "Pattern trigger" on page 398

16 Remote Control Commands

This chapter provides the description of all remote commands available for R&S RTM3000. The commands are sorted according to the menu structure of the instrument. A list of commands in alphabetical order is given in the "List of Commands" at the end of this documentation.

Processing of remote control commands

The response time on remote commands depends on several factors:

- Number of active channels
- Number of active measurements
- Size of the acquisition memory
- Timebase
- Trigger frequency

The R&S RTM3000 processes measurement queries in the following way:

- In stop mode or with slow trigger frequency if no new data since last value calculation is available, the oscilloscope sends the measured value in the response.
- Otherwise, if new data since last value calculation is available, the oscilloscope calculates and sends the response.

• Conventions used in Command Description	404
• Programming Examples	405
• Common Commands	411
• Waveform Setup	414
• Trigger	436
• Waveform Analysis	451
• Measurements	488
• Applications	507
• Documenting Results	539
• General Instrument Setup	560
• Serial Bus Analysis	574
• Power Analysis (Option R&S RTM-K31)	684
• Mixed Signal Option (Option R&S RTM-B1)	737
• Signal Generation (Option R&S RTM-B6)	748
• Status Reporting	764

16.1 Conventions used in Command Description

Note the following conventions used in the remote command descriptions:

- **Command usage**
If not specified otherwise, commands can be used both for setting and for querying parameters.
If a command can be used for setting or querying only, or if it initiates an event, the usage is stated explicitly.

- **Parameter usage**
If not specified otherwise, a parameter can be used to set a value and it is the result of a query.
Parameters required only for setting are indicated as **Setting parameters**.
Parameters required only to refine a query are indicated as **Query parameters**.
Parameters that are only returned as the result of a query are indicated as **Return values**.
- **Conformity**
Commands that are taken from the SCPI standard are indicated as **SCPI confirmed**. All commands used by the R&S RTM3000 follow the SCPI syntax rules.
- **Asynchronous commands**
A command which does not automatically finish executing before the next command starts executing (overlapping command) is indicated as an **Asynchronous command**.
- **Reset values (*RST)**
Default parameter values that are used directly after resetting the instrument (*RST command) are indicated as ***RST** values, if available.
- **Default unit**
The default unit is used for numeric values if no other unit is provided with the parameter.

16.2 Programming Examples

• Documenting Results	405
• Firmware Update	409
• Search	410
• Function Generator	411

16.2.1 Documenting Results

• Saving Screenshots to File	405
• Saving, Copying, and Loading Setup Data	406
• Reading Waveform Data in Real Format	407
• Reading Waveform Data in Unsigned Integer Format	407

16.2.1.1 Saving Screenshots to File

Save two display images in png format to the `PIX` folder on a USB flash drive that is connected to the front panel. One screenshot is colored and the other is grayscale. Finally, the data of the gray screenshot is read for further user on the control computer.

Command description in: [Chapter 16.9.3, "Screenshots"](#), on page 552.

```
*RST
MMEM:CDIR "/USB_FRONT"
MMEM:MDIR "/USB_FRONT/PIX"
```

```

MEMM:CDIR "/USB_FRONT/PIX/"

HCOP:LANG PNG
HCOP:COL:SCH COL
MEMM:NAME "COLORED"
HCOP:IMM
HCOP:COL:SCH GRAY
MEMM:NAME "GRAY"
HCOP:IMM

MEMM:CAT? "*.PNG"
MEMM:DATA? "GRAY.PNG"

```

16.2.1.2 Saving, Copying, and Loading Setup Data

Save instrument settings to a file on internal storage device, duplicate this file and save it to a USB stick attached to the front panel. Finally, there are three setup files on the internal storage /INT/SETTINGS, and one file on the USB flash device.

Command description in: [Chapter 16.9.4, "Instrument Settings: Mass MEMemory Sub-system"](#), on page 554.

```

CHAN1:STAT ON // Turn channel 1 on
CHAN2:STAT ON // Turn channel 2 on
TIM:ZOOM:STAT ON // Show zoom diagram
MEMM:CDIR "/INT/SETTINGS" // Set storage device and directory
MEMM:STOR:STAT 1,"ZOOM_A.SET" // Save settings to internal storage
MEMM:CAT? "*.SET" // Check
<-- 332112,8633856,"ZOOM_A.SET,,2759"
MEMM:COPY "ZOOM_A.SET","ZOOM_B.SET" // Copy file
MEMM:CAT? "*.SET" // Check
<-- 332112,8633856,"ZOOM_A.SET,,2759","ZOOM_B.SET,,2759"
MEMM:COPY "/INT/SETTINGS/ZOOM_B.SET","/USB_FRONT/ZOOM_B.SET"
// Save copied file to USB stick
MEMM:CDIR "/USB_FRONT" // Check
MEMM:CAT? "*.SET"
<-- 4890624,-641765376,"ZOOM_B.SET,,2759"
MEMM:COPY "/USB_FRONT/ZOOM_B.SET","/USB_FRONT/ZOOM_USB.SET"
// Duplicate file on USB stick
MEMM:CAT? "*.SET" // Check
<-- 4890624,-641765376,"ZOOM_B.SET,,2759","ZOOM_USB.SET,,2759"
MEMM:DEL "ZOOM_B.SET" // Delete original file
MEMM:CAT? "*.SET" // Check
<-- 4886528,-641765376,"ZOOM_USB.SET,,2759"
MEMM:COPY "/USB_FRONT/ZOOM_USB.SET","/INT/SETTINGS/"
// Copy new file to the instrument
MEMM:CDIR "/INT/SETTINGS" // Check
MEMM:CAT? "*.SET"
<-- 332112,8633856,"ZOOM_A.SET,,2759","ZOOM_B.SET,,2759","ZOOM_USB.SET,,2759"
*RST;*OPC?

```

```
<-- 1
MMEM:CDIR "/INT/SETTINGS"
MMEM:LOAD:STAT 1,"ZOOM_USB.SET" // Load settings
```

16.2.1.3 Reading Waveform Data in Real Format

Set data format and sample range, read channel header and data.

Command description in [Chapter 16.9.1, "Transfer of Waveform Data"](#), on page 539.
Return values are example data.

```
// Check instrument connection (example)

* Connected to: TCPIP0::192.168.1.1::inst0::INSTR
SYST:ERR:ALL?
<-- 0,"No error" // if error queue is empty
*IDN?
<-- Rohde&Schwarz,RTM3004,1335.8794K04/101489,01.402

// Read waveform data
*RST
CHAN:TYPE HRES // Set high resolution mode (16 bit data)
TIM:SCAL 1E-7 // Set time base
FORM REAL // Set REAL data format
FORM:BORD LSBF // Set little endian byte order
CHAN:DATA:POIN DMAX // Set sample range to memory data in displayed time range
SING;*OPC? // Start single acquisition
<-- 1
CHAN:DATA:HEAD? // Read header
<-- -4.9980E-07,5.0000E-07,5000,1 // Xstart, Xstop, record length in samples
CHAN:DATA? // Read channel data
<-- #520000>??[>??[>??[>??[>??[>??[>??... // Binary block data,
// 4-byte floating point number/sample
```

16.2.1.4 Reading Waveform Data in Unsigned Integer Format

Read the channel header, the waveform conversion data, set the UINT binary data format and read the channel data.

Command description in: [Chapter 16.9.1, "Transfer of Waveform Data"](#), on page 539.
Return values are example data.

```
*RST
TIM:SCAL 1E-7
CHAN:DATA:POIN DMAX // Set data range
SING;*OPC?
<-- 1
CHAN:DATA:HEAD? // Read header
<-- -4.9980E-07,5.0000E-07,5000,1 // Xstart, Xstop, record length in samples
CHAN:DATA:YRES? // Read vertical resolution
<-- 8
CHAN:DATA:YOR? // Read voltage value for binary value 0
```

```

<-- -2.549999943E-2
CHAN:DATA:XOR?           // Read time of the first sample
<-- -4.998000058E-7
CHAN:DATA:XINC?         // Read time between two adjacent samples
<-- 2.000000023E-10
FORM UINT,8;FORM?      // Set data format to unsigned integer, 8 bit
<-- UINT,8
CHAN:DATA:YINC?        // Read voltage value per bit
<-- 1.999999949E-4
CHAN:DATA?             // Read channel data
<-- 128,125,120...     // 5000 bytes total
FORM UINT,16;FORM?    // Change data format to unsigned integer, 16 bit
<-- UINT,16
CHAN:DATA:YINC?        // Read voltage value per bit
<-- 7.812499803E-7
CHAN:DATA?             // Read channel data
<-- 32768,32000,30720... // 10000 bytes total

```

Note the following correlations:

- The number of received data values matches the number of samples indicated in the header.
- The time of the first sample (XORigin) matches the start time Xstart indicated in the header.
- The Y-increment adjusts to the data length defined in the data format (8 or 16 bit).

Data conversion

Definition: the sample numbers start with 0 and end with *record length - 1*.

Sample time

$$t_n = n * xIncrement + xOrigin$$

First sample: $t_0 = -4.998000058E-7$ (= Xstart)

Last sample: $t_{4999} = 4999 * 2E^{-10} - 4.998E^{-7} = 5.0 E^{-7}$ (= Xstop)

Sample value

$$Y_n = yOrigin + (yIncrement * byteValue_n)$$

The format UINT, 8 has the data range 0 to 255. The voltage value for byte value 128 is:

$$Y_n = -2.55E^{-2} + (2E^{-4} * 128) = 0.0001$$

The center of the display at position 0 div always has the byte value 127.5. The corresponding voltage value is:

$$Y_n = -2.55E^{-2} + (2E^{-4} * 127.5) = 0$$

8-bit and 16-bit data

At the end of the above example, the 8-bit waveform is read as 16-bit data, for example, `0xFF` is read `0xFF00`, or `0x1A` is read `0x1A00`. The *yOrigin* value is the same in both cases, but the *yIncrement* differs.

	8-bit data	16-bit data	Result
$yIncrement * byteValue_n$	$2e^{-4} * 128$	$7,8125E^{-7} * 32768$	0,0256 V
	$2e^{-4} * 125$	$7,8125E^{-7} * 32000$	0,025 V

In the reverse case, if a 16-bit waveform is read with 8-bit data format, data precision may be reduced. Data values are truncated, and only the more significant bits remain. For example, the 16-bit data `0xabcd` is read `0xab` in 8-bit format, and `cd` is lost.

16.2.2 Firmware Update

There are two ways to update the firmware on the instrument remotely. The web browser does not yet include firmware update functionality.

To prepare the remote update, configure the instrument's interface to Ethernet, USB TMC or USB VCP. Connect to the R&S RTM3000 using a socket connection, Visa or a terminal program.

16.2.2.1 Using `M MEM:DATA + DIAGnostic:UPDate:LOAD`

- Send the firmware update file data to the internal storage of the instrument, for example:

```
:M MEM:DATA "/INT/RTM3004.FWU",blockdata\n
```

In SCPI, block data is composed of a header `#nm` containing the length of the data followed by the data in raw binary format. Here, `m` is the length of the data in byte, and `n` is the number of digits in `m`. The firmware update file has to be sent in a single transfer.
- Start the firmware update:

```
:DIAG:UPD:LOAD "/INT/RTM3004.FWU"\n
```

The instrument loads, checks and executes the firmware update, and restarts.
- After restart, delete the firmware update file in the internal storage:

```
:M MEM:DEL "/INT/RTM3004.FWU"\n
```

16.2.2.2 Using `DIAGnostic:UPDdate:TRANsfer`

- Open a data transfer for the firmware update file, and check for errors:

```
:DIAG:UPD:TRAN:OPEN FIRM\n
:SYST:ERR:ALL?
```

2. Send the firmware update file data to the internal RAM of the instrument:
`:DIAG:UPD:TRAN:DATA offset,checksum,blockdata\n`
 The offset parameter specifies the byte offset of the blockdata in the file. The checksum parameter is a CRC-16-CCITT type checksum calculated for the raw binary data in blockdata. In SCPI, block data is composed of a header #nm containing the length of the data followed by the data in raw binary format. Here, m is the length of the data in byte, and n is the number of digits in m.
 The firmware update file can be split into multiple blocks, where each block has to be transferred with the above command. You can also transfer the file in a single block.
 Example to send all data at once, without CRC:
`DUT#sendRAW DIAG:UPD:TRAN:DATA 0,0,#822393104`
`DUT#sendFileContent "W:\RTM3004.FWU"`
`DUT#sendByte 10 //end of command '\n'`
3. Close the transfer:
`:DIAG:UPD:TRAN:CLOSE\n`
4. Start the firmware update:
`:DIAG:UPD:INST ""\n`
 The instrument checks and executes the firmware update.

16.2.3 Search

16.2.3.1 Searching for a Pulse of Specified Width

Search for positive pulses with pulse width $12 \pm 10 \mu\text{s}$ ($2 \mu\text{s}$ to $22 \mu\text{s}$).

Command description in: [Chapter 16.6.4, "Search"](#), on page 460.

Prerequisite: A pulse signal is connected to channel 2.

```
SEAR:STAT ON           // Turn on search
SEAR:COND WIDTH        // Select search condition
SEAR:SOUR CH2          // Configure search source
SEAR:TRIG:WIDT:POL POS // Configure search parameters: Polarity
SEAR:TRIG:WIDT:RANG WITH // Configure search parameters: Condition = within
SEAR:TRIG:WIDT:WIDT 12e-6 // Configure search parameters: Pulse width
SEAR:TRIG:WIDT:DELT 10e-6 // Configure search parameters: +/- delta
SEAR:RESD:SHOW ON      // Show result table
SEAR:RCO?              // Get number of search events found
<-- 1.400E+01
SEAR:RES:ALL?          // Get all search results
<-- 1,5.201200e-06,0,WIDTH,POSITIVE,1.220160e-05,2,4.120040e-05,0,WIDTH,
    POSITIVE,3.076800e-06,3,4.732480e-05,0,WIDTH,POSITIVE,9.127200e-06,4,
    6.499960e-05,0,WIDTH,POSITIVE,1.835160e-05,5,8.634920e-05,0,WIDTH,POSITIVE,
    3.052000e-06,6,1.293984e-04,0,WIDTH,POSITIVE,9.176800e-06,7,1.477228e-04,0,
    WIDTH,POSITIVE,3.052000e-06,8,1.623224e-04,0,WIDTH,POSITIVE,3.102000e-06,9,
```

```
1.684724e-04,0,WIDTH,POSITIVE,1.215160e-05,10,1.953216e-04,0,WIDTH,POSITIVE,
3.027200e-06,11,2.044716e-04,0,WIDTH,POSITIVE,6.052000e-06,12,2.252212e-04,0,
WIDTH,POSITIVE,3.052000e-06,13,2.435456e-04,0,WIDTH,POSITIVE,3.027200e-06,14,
2.496456e-04,0,WIDTH,POSITIVE,6.702000e-06
```

16.2.4 Function Generator

Configure and output a sine waveform.

Command description in: [Chapter 16.14.1, "Function Generator"](#), on page 748.

Prerequisite: To see the generated waveform on the oscilloscope, connect the "Gen" output to "Ch1" input.

```
*RST
WGEN:FUNC SIN           // Selects sine function
WGEN:VOLT 700E-3        // Sets the amplitude
WGEN:FREQ 1.00E+06      // Sets the frequency
WGEN:OUTP:LOAD R50     // Sets the user load
WGEN:OUTP 1             // Outputs the sine waveform
AUT                     // Autoscale to see the waveform
```

16.3 Common Commands

Common commands are described in the IEEE 488.2 (IEC 625-2) standard. These commands have the same effect and are employed in the same way on different devices. The headers of these commands consist of "*" followed by three letters. Many common commands are related to the Status Reporting System.

Available common commands:

*CAL?	411
*CLS	412
*ESE	412
*ESR?	412
*IDN?	412
*OPC	412
*OPT?	413
*PSC	413
*RST	413
*SRE	413
*STB?	414
*TRG	414
*WAI	414

*CAL?

Performs a self-alignment of the instrument and then generates a status response. Return values $\neq 0$ indicate an error.

Usage: Query only

*CLS

Clear status

Sets the status byte (STB), the standard event register (ESR) and the `EVENT` part of the `QUESTIONABLE` and the `OPERATION` registers to zero. The command does not alter the mask and transition parts of the registers. It clears the output buffer.

Usage: Setting only

*ESE <Value>

Event status enable

Sets the event status enable register to the specified value. The query returns the contents of the event status enable register in decimal form.

Parameters:

<Value> Range: 0 to 255

*ESR?

Event status read

Returns the contents of the event status register in decimal form and then sets the register to zero.

Return values:

<Contents> Range: 0 to 255

Usage: Query only

*IDN?

Identification

Returns the instrument identification.

Return values:

<ID> "Rohde&Schwarz,<device type>,<serial number>,<firmware version>"

Example: Rohde&Schwarz,RTM3004,1335.8794k04/900012,01.100

Usage: Query only

*OPC

Operation complete

Sets bit 0 in the event status register when all preceding commands have been executed. This bit can be used to initiate a service request. The query writes a "1" into the output buffer when all preceding commands have been executed, which is useful for command synchronization.

*OPT?

Option identification query

Queries the options included in the instrument. For a list of all available options and their description, refer to the data sheet.

Return values:

<Options> The query returns a list of options. The options are returned at fixed positions in a comma-separated string. A zero is returned for options that are not installed.

Usage: Query only

*PSC <Action>

Power on status clear

Determines whether the contents of the `ENABLE` registers are preserved or reset when the instrument is switched on. Thus a service request can be triggered when the instrument is switched on, if the status registers ESE and SRE are suitably configured. The query reads out the contents of the "power-on-status-clear" flag.

Parameters:

<Action> 0 | 1
0
 The contents of the status registers are preserved.
1
 Resets the status registers.

*RST

Reset

Sets the instrument to a defined default status. The default settings are indicated in the description of commands.

Usage: Setting only

*SRE <Contents>

Service request enable

Sets the service request enable register to the indicated value. This command determines under which conditions a service request is triggered.

Parameters:

<Contents> Contents of the service request enable register in decimal form.
Bit 6 (MSS mask bit) is always 0.
Range: 0 to 255

***STB?**

Status byte query

Reads the contents of the status byte in decimal form.

Usage: Query only

***TRG**

Trigger

Triggers all actions waiting for a trigger event. In particular, *TRG generates a manual trigger signal. This common command complements the commands of the TRIGger subsystem.

Usage: Event

***WAI**

Wait to continue

Prevents servicing of the subsequent commands until all preceding commands have been executed and all signals have settled (see also command synchronization and *OPC).

Usage: Event

16.4 Waveform Setup

• Automatic Setup	415
• Starting and Stopping Acquisition	415
• Vertical Settings	416
• Passive Probes	423
• Active Probes	424
• Horizontal Settings	429
• Acquisition Settings	431
• Waveform Data	435

16.4.1 Automatic Setup

AUToscale

Performs an autoset process for analog channels: analyzes the enabled analog channel signals, and adjusts the horizontal, vertical, and trigger settings to display stable waveforms

Usage: Event
Asynchronous command

16.4.2 Starting and Stopping Acquisition

RUN.....	415
RUNContinuous.....	415
SINGLE.....	415
RUNSingle.....	415
ACQUIRE:NSINGLE:COUNT.....	415
STOP.....	416
ACQUIRE:STATE.....	416

RUN

RUNContinuous

Starts the continuous acquisition.

Usage: Event
Asynchronous command

SINGLE

RUNSingle

Starts a defined number of acquisitions. The number of acquisitions is set with [ACQUIRE:NSINGLE:COUNT](#).

Usage: Event
Asynchronous command

ACQUIRE:NSINGLE:COUNT <NSingleCount>

Sets the number of waveforms acquired with [RUNSingle](#).

Parameters:

<NSingleCount>	Number of waveforms.
Range:	1 to maximum number that depends on the record length.
*RST:	1

STOP

Stops the running acquisition.

Usage: Event
Asynchronous command

ACQUIRE:STATE

Sets or queries the acquisition state of the instrument.

Parameters:

<AcquisitionState> RUN | STOPping | COMPLETE | BREak

RUN

Set: Starts the acquisition.

Read: The acquisition is running.

STOPping

Set: Stops the acquisition when it is finished.

Read: Acquisition is stopped.

COMPLETE

Set: Not available.

Read: The current acquisition is finished and completed.

BREak

Set: Immediate interrupt of current acquisition.

Read: acquisition is finished but interrupted.

16.4.3 Vertical Settings

CHANnel<m>:STATe.....	417
CHANnel<m>:AON.....	417
CHANnel<m>:AOFF.....	417
CHANnel<m>:SCALE.....	417
CHANnel<m>:RANGE.....	417
CHANnel<m>:POSITION.....	418
CHANnel<m>:OFFSet.....	418
CHANnel<m>:COUPling.....	418
CHANnel<m>:BANDwidth.....	419
CHANnel<m>:POLarity.....	419
CHANnel<m>:SKEW.....	420
CHANnel<m>:ZOFFset[VALue].....	420
CHANnel<m>:WCOLor.....	420
CHANnel<m>:OVERload.....	421
CHANnel<m>:THReshold.....	421
CHANnel<m>:THReshold:FINDlevel.....	422
CHANnel<m>:THReshold:HYSteresis.....	422
CHANnel<m>:LABel.....	422
CHANnel<m>:LABel:STATe.....	422

CHANnel<m>:STATe <State>

Switches the channel signal on or off.

Suffix:

<m> 1..4
Selects the input channel. The number of channels depends on the instrument.

Parameters:

<State> ON | OFF

CHANnel<m>:AON

Switches all analog channels on.

Suffix:

<m> The suffix is irrelevant.

Usage: Event

CHANnel<m>:AOFF

Switches all analog channels off.

Suffix:

<m> The suffix is irrelevant.

Usage: Event

CHANnel<m>:SCALE <Scale>

Sets the vertical scale for the indicated channel.

Suffix:

<m> 1..4
Selects the input channel. The number of channels depends on the instrument.

Parameters:

<Scale> Scale value, given in Volts per division.
Range: 1e-3 to 10 (without probe attenuation)
*RST: 5e-3
Default unit: V/div

CHANnel<m>:RANGE <Range>

Sets the voltage range across the all vertical divisions of the diagram. Use the command alternatively instead of [CHANnel<m>:SCALE](#).

Suffix:

<m> 1..4
 Selects the input channel. The number of channels depends on the instrument.

Parameters:

<Range> Voltage range value
 Range: 8e-3 to 80 (without probe attenuation)
 *RST: 40e-3
 Default unit: V

CHANnel<m>:POSition <Position>

Sets the vertical position of the waveform in divisions. While the offset sets a voltage, position is a graphical setting given in divisions.

Suffix:

<m> 1..4
 Selects the input channel. The number of channels depends on the instrument.

Parameters:

<Position> Graphical position
 Range: -5 to 5
 *RST: 0
 Default unit: div

CHANnel<m>:OFFSet <Offset>

Sets the offset voltage, which is subtracted to correct an offset-affected signal.

Suffix:

<m> 1..4
 Selects the input channel. The number of channels depends on the instrument.

Parameters:

<Offset> Offset value
 Range: Depend on vertical scale and probe attenuation.
 Increment: Depends on vertical scale and probe attenuation.
 *RST: 0
 Default unit: V

CHANnel<m>:COUPling <Coupling>

Selects the connection of the indicated channel signal - coupling and termination.

Suffix:

<m> 1..4
Selects the input channel. The number of channels depends on the instrument.

Parameters:

<Coupling> DCLimit | ACLimit | GND | DC

DCLimit
DC coupling passes the input signal unchanged.

ACLimit
Removes the DC offset voltage from the input signal.

GND
Connection to a virtual ground. All channel data is set to 0 V.

DC
Direct connection with 50 Ω termination. If termination is 1 M Ω , use DCLimit or ACLimit.

CHANnel<m>:BANDwidth <BandwidthLimit>

Selects the bandwidth limit for the indicated channel.

Suffix:

<m> 1..4
Selects the input channel. The number of channels depends on the instrument.

Parameters:

<BandwidthLimit> FULL | B20

FULL
Use full bandwidth.

B20
Limit to 20 MHz. Higher frequencies are removed to reduce noise.

*RST: FULL

CHANnel<m>:POLarity <Polarity>

Turns the inversion of the signal amplitude on or off. To invert means to reflect the voltage values of all signal components against the ground level. Inversion affects only the display of the signal but not the trigger.

Suffix:

<m> 1..4
Selects the input channel. The number of channels depends on the instrument.

Parameters:

<Polarity> NORMal | INVerted

*RST: NORM

CHANnel<m>:SKEW <Skew>

Sets a delay for the selected channel.

Deskew compensates delay differences between channels caused by the different length of cables, probes, and other sources. Correct deskew values are important for accurate triggering.

Suffix:

<m> 1..4
Selects the input channel. The number of channels depends on the instrument.

Parameters:

<Skew> Deskew value
Default unit: s

CHANnel<m>:ZOFFset[:VALue] <ZeroOffset>

Sets the zero offset.

Differences in DUT and oscilloscope ground levels may cause larger zero errors affecting the waveform. If the DUT is ground-referenced, the "Zero Offset" corrects the zero error and sets the probe to the zero level.

You can assess the zero error by measuring the mean value of a signal that should return zero.

Suffix:

<m> 1..4
Selects the input channel. The number of channels depends on the instrument.

Parameters:

<ZeroOffset> *RST: 0
Default unit: V

CHANnel<m>:WCOLor <WaveformColor>

Selects the color scale for the waveform color. Each scale comprises a set of colors, where each color represents a certain frequency of occurrence.

Suffix:

<m> 1..4
Selects the input channel. The number of channels depends on the instrument.

Parameters:

<WaveformColor> TEMPerature | RAINbow | FIRE | DEFault

TEMPerature

Temperature colors. Blue corresponds to rare occurrences of the samples, while white indicates frequent ones.

RAINbow

Rainbow colors. Blue corresponds to rare occurrences of the samples, while red indicates frequent ones.

FIRE

Fire colors. Yellow corresponds to rare occurrences of the samples, while red indicates frequent ones.

DEFault

Default monochrome color.

*RST: DEF

CHANnel<m>:OVERload <Overload>

Retrieves the overload status of the specified channel from the status bit. When the overload problem is solved, the command resets the status bit.

Suffix:

<m> 1..4
Selects the input channel. The number of channels depends on the instrument.

Parameters:

<Overload> ON | OFF
Use OFF to reset the overload status bit.
*RST: OFF

Example:

CHANnel2:OVERload?
Queries the overload status of channel 2.
CHANnel2:OVERload OFF
Resets the overload status bit.

CHANnel<m>:THReshold <Threshold>

Threshold value for digitization of analog signals. If the signal value is higher than the threshold, the signal state is high (1 or true for the Boolean logic). Otherwise, the signal state is considered low (0 or false) if the signal value is below the threshold.

Suffix:

<m> 1..4
Selects the input channel. The number of channels depends on the instrument.

Parameters:

<Threshold> Often used values are:
TTL: 1.4 V
ECL: -1.3 V
CMOS: 2.5 V
Default unit: V

CHANnel<m>:THReshold:FINDlevel

The instrument analyzes the channel and sets the threshold for digitization.

Suffix:

<m> 1..4
Selects the input channel. The number of channels depends on the instrument.

Parameters:

<FindLevel>

Usage: Event

CHANnel<m>:THReshold:HYSTeresis <ThresholdHysteresis>

Defines the size of the hysteresis to avoid the change of signal states due to noise.

Suffix:

<m> 1..4
Selects the input channel. The number of channels depends on the instrument.

Parameters:

<ThresholdHysteresis>SMAL | MEDium | LARGe
Values correspond to the vertical scale
*RST: SMAL

CHANnel<m>:LABel <Label>

Specifies a name for the selected channel.

Suffix:

<m> 1..4
Selects the input channel. The number of channels depends on the instrument.

Parameters:

<Label> String value
String with max. 8 characters, only ASCII characters can be used

CHANnel<m>:LABel:STATe

Shows or hides the channel name.

Suffix:

<m> 1..4
Selects the input channel. The number of channels depends on the instrument.

Parameters:

<State> ON | OFF
 *RST: OFF

16.4.4 Passive Probes

PROBe<m>:SETup:ATTenuation:UNIT.....	423
PROBe<m>:SETup:ATTenuation:MANual.....	423
PROBe<m>:SETup:GAIN:UNIT.....	423
PROBe<m>:SETup:GAIN:MANual.....	424

PROBe<m>:SETup:ATTenuation:UNIT <Unit>

Selects the unit that the probe can measure.

Suffix:

<m> 1..4
 Selects the input channel. The number of channels depends on the instrument.

Parameters:

<Unit> V | A

PROBe<m>:SETup:ATTenuation:MANual <ManualAttenuation>

Sets the attenuation of the probe.

Suffix:

<m> 1..4
 Selects the input channel. The number of channels depends on the instrument.

Parameters:

<ManualAttenuation> Range: 0.0001 to 10000
 *RST: 1

PROBe<m>:SETup:GAIN:UNIT <Unit>

Selects the unit that the probe can measure.

Suffix:

<m> 1..4
 Selects the input channel. The number of channels depends on the instrument.

Parameters:

<Unit> V | A

PROBe<m>:SETup:GAIN:MANual <ManualGain>

Sets the gain of the probe. The gain is the reciprocal of the attenuation (`PROBe<m>:SETup:ATTenuation:MANual`)

Suffix:

<m> 1..4
Selects the input channel. The number of channels depends on the instrument.

Parameters:

<ManualGain> Range: 0.0001 to 10000

16.4.5 Active Probes

The commands in this chapter are only valid for Rohde & Schwarz active probes.

<code>PROBe<m>:SETup:OFFSwitch</code>	424
<code>PROBe<m>:SETup:DCOffset?</code>	425
<code>PROBe<m>:SETup:MODE</code>	425
<code>PROBe<m>:ID:BUILd?</code>	425
<code>PROBe<m>:ID:PARTnumber?</code>	426
<code>PROBe<m>:ID:PRDate?</code>	426
<code>PROBe<m>:ID:SRNumber?</code>	426
<code>PROBe<m>:ID:SWVersion?</code>	426
<code>PROBe<m>:SETup:TYPE?</code>	427
<code>PROBe<m>:SETup:NAME?</code>	427
<code>PROBe<m>:SETup:BANDwidth?</code>	427
<code>PROBe<m>:SETup:ATTenuation[:AUTO]?</code>	427
<code>PROBe<m>:SETup:GAIN[:AUTO]?</code>	428
<code>PROBe<m>:SETup:CAPacitance?</code>	428
<code>PROBe<m>:SETup:IMPedance?</code>	428
<code>PROBe<m>:SETup:DEGauss</code>	429

PROBe<m>:SETup:OFFSwitch <DCOffsetOnOff>

Switches the integrated voltmeter of a Rohde & Schwarz active probe on or off. The command is only available if a Rohde & Schwarz active probe with R&S ProbeMeter is used.

Suffix:

<m> Selects the input channel. The number of channels depends on the instrument.

Parameters:

<DCOffsetOnOff> ON | OFF
*RST: OFF

PROBe<m>:SETup:DCOffset?

Returns the DC voltage that is measured by the integrated voltmeter of Rohde & Schwarz active probes. Before using this command, switch the voltmeter on, see [PROBe<m>:SETup:OFFSwitch](#). The command is only available if a Rohde & Schwarz active probe with R&S ProbeMeter is used.

Suffix:

<m> Selects the input channel. The number of channels depends on the instrument.

Return values:

<Offset> Range: -1.0e26 to 1.0e-26
Increment: 1e-3
Default unit: V

Example:

```
PROBe2:SETup:OFFSwitch ON
PROBe2:SETup:DCOffset?
<-- 0.003
```

Usage:

Query only

PROBe<m>:SETup:MODE <Mode>

Selects the action that is started with the probe button.

Suffix:

<m> Selects the input channel. The number of channels depends on the instrument.

Parameters:

<Mode> RCONtinuous | RSINgle | AUToset | NOACtion

RCONtinuous

Starts continuous acquisition, like the [Run Stop] key. The acquisition is running as long as you press the micro button again.

RSINgle

Run single: starts one acquisition.

AUToset

Starts the autosegment procedure.

NOACtion

Nothing is started on pressing the micro button.

*RST: RCONtinuous

PROBe<m>:ID:BUILD?

Returns the build number of the probe software.

Suffix:

<m> Selects the input channel. The number of channels depends on the instrument.

Return values:

<BuildNumber> 32 bit number
Range: 0 to 4294967295
Increment: 1

Usage: Query only

PROBe<m>:ID:PARTnumber?

Returns the R&S part number of the probe.

Suffix:

<m> Selects the input channel. The number of channels depends on the instrument.

Return values:

<PartNumber> Part number in a string

Usage: Query only

PROBe<m>:ID:PRDate?

Returns the production date of the probe.

Suffix:

<m> Selects the input channel. The number of channels depends on the instrument.

Return values:

<ProductionDate> Date in a string

Usage: Query only

PROBe<m>:ID:SRNumber?

Returns the serial number of the probe.

Suffix:

<m> Selects the input channel. The number of channels depends on the instrument.

Return values:

<SerialNumber> Serial number in a string

Usage: Query only

PROBe<m>:ID:SWVersion?

Returns the version of the probe firmware.

Suffix:

<m> Selects the input channel. The number of channels depends on the instrument.

Return values:

<SoftwareVersion> Version number in a string.

Usage: Query only

PROBe<m>:SETup:TYPE?

Returns the type of the probe: not detected, active or passive probe.

Suffix:

<m> Selects the input channel. The number of channels depends on the instrument.

Return values:

<Type> NONE | ACTive | PASSive

Usage: Query only

PROBe<m>:SETup:NAME?

Returns the name of the probe.

Suffix:

<m> Selects the input channel. The number of channels depends on the instrument.

Return values:

<Name> String parameter

Example:

```
PROB:SET:NAME?
<-- "RT-ZS20"
```

Usage: Query only

PROBe<m>:SETup:BANDwidth?

Returns the bandwidth of the probe.

Suffix:

<m> Selects the input channel. The number of channels depends on the instrument.

Return values:

<Bandwidth> Range: 10e5 to 20e8
Increment: 10
Default unit: Hz

Usage: Query only

PROBe<m>:SETup:ATTenuation[:AUTO]?

Returns the attenuation of an automatically detected probe.

Suffix:

<m> 1..4
Selects the input channel. The number of channels depends on the instrument.

Return values:

<ProbeAttenuation> Range: 0.0001 to 10000

Usage: Query only

PROBe<m>:SETup:GAIN[:AUTO]?

Returns the gain of an automatically detected probe.

Suffix:

<m> 1..4
Selects the input channel. The number of channels depends on the instrument.

Return values:

<ProbeGain> Range: 0.0001 to 10000

Usage: Query only

PROBe<m>:SETup:CAPacitance?

Returns the input capacity of the probe.

Suffix:

<m> Selects the input channel. The number of channels depends on the instrument.

Return values:

<InputCapacitance> Range: 0.1e-12 to 1.0e-9
Increment: 1.0e-12
Default unit: F

Usage: Query only

PROBe<m>:SETup:IMPedance?

Returns the termination of the probe.

Suffix:

<m> Selects the input channel. The number of channels depends on the instrument.

Return values:

<Termination> 50OHm | 1MOHm | UNKNown

Usage: Query only

PROBe<m>:SETup:DEGauss

Demagnetizes the core if it has been magnetized by switching the power on and off, or by an excessive input. Always demagnetize the probe before measurement. The demagnetizing process takes about one second.

Suffix:

<m> 1..4
Selects the input channel. The number of channels depends on the instrument.

Usage: Event

16.4.6 Horizontal Settings

TIMebase:SCALe	429
TIMebase:POSition	429
TIMebase:REFerence	430
TIMebase:ACQTime	430
TIMebase:RANGe	430
TIMebase:DIVisions?	430
TIMebase:RATime?	430

TIMebase:SCALe <TimeScale>

Sets the horizontal scale for all channel and math waveforms.

Parameters:

<TimeScale> Range: 1e-9 to 50; lower limits are possible if zoom or FFT is enabled.
Increment: 1e-9
*RST: 100e-6
Default unit: s/div

TIMebase:POSition <Offset>

Defines the trigger position, the time distance from the trigger point to the reference point (trigger offset). The trigger point is the zero point of the diagram. Changing the horizontal position, you can move the trigger, even outside the screen.

See also: [TIMebase:REFerence](#) on page 430

Parameters:

<Offset> Range: Depends on time base setting
Increment: 0.01
*RST: 0
Default unit: s

TIMEbase:REFerence <ReferencePoint>

Defines the time reference point in the diagram. The reference point is the rescaling center of the time scale on the screen. If you modify the time scale, the reference point remains fixed on the screen, and the scale is stretched or compressed to both sides of the reference point.

The reference point defines which part of the waveform is shown. By default, the reference point is displayed in the center of the window, and you can move it to the left or right.

See also: [TIMEbase:POSition](#) on page 429

Parameters:

<ReferencePoint> 8.33 | 50 | 91.67
 8.33 = left position (1 div); 50 = middle position; 91.67 = right position (11 div).
 *RST: 50
 Default unit: %

TIMEbase:ACQTime <AcquisitionTime>**TIMEbase:RANGe** <AcquisitionTime>

Defines the time of one acquisition, that is the time across the 10 divisions of the diagram: $Timebase\ Scale * 10$.

Parameters:

<AcquisitionTime> Range and increment depend on time base and other settings
 Range: 250e-12 to 500
 Increment: 1e-12
 Default unit: s

TIMEbase:DIVisions?

Queries the number of horizontal divisions on the screen.

Return values:

<HorizDivCount> Returns 12 divisions.

Usage: Query only

TIMEbase:RATime?

Queries the real acquisition time used in the hardware. If FFT analysis is performed, the value can differ from the adjusted acquisition time ([TIMEbase:ACQTime](#)).

Return values:

<HWAcqTime> Range: Depends on various settings
 Default unit: s

Usage: Query only

16.4.7 Acquisition Settings

ACQUIRE:POINTS:AUTOMATIC.....	431
ACQUIRE:POINTS[:VALUE].....	431
CHANNEL<m>:TYPE.....	432
CHANNEL<m>:ARITHMETICS.....	432
ACQUIRE:PEAKDETECT.....	433
ACQUIRE:HRESOLUTION.....	433
ACQUIRE:NSINGLE:COUNT.....	433
ACQUIRE:AVERAGE:COUNTE.....	433
ACQUIRE:AVERAGE:RESET.....	433
ACQUIRE:AVERAGE:COMPLETE?.....	434
TIMEBASE:ROLL:AUTOMATIC.....	434
TIMEBASE:ROLL:MTIME.....	434
ACQUIRE:INTERPOLATE.....	434
ACQUIRE:POINTS:ARATE?.....	435
ACQUIRE:SRATE?.....	435

ACQUIRE:POINTS:AUTOMATIC <AutoRecordLength>

Enables or disables the automatic record length. The instrument sets a value that fits to the selected timebase.

If you set a specific value with `ACQUIRE:POINTS[:VALUE]`, the automatic assignment of a record length is turned off.

Parameters:

<AutoRecordLength> ON | OFF

Example:

```
ACQ:POIN:AUT ON
TIM:SCAL 1e-9
ACQ:POIN?::SYST:ERR:ALL?
-> received 10000;0,"No error"
TIM:SCAL 5e-3
ACQ:POIN?::SYST:ERR:ALL?
-> received 20000000;0,"No error"
```

ACQUIRE:POINTS[:VALUE]

Defines a record length value, the number of recorded waveform points in a segment.

The command turns `ACQUIRE:POINTS:AUTOMATIC` OFF.

If `ACQUIRE:POINTS:AUTOMATIC` is turned ON, the query `ACQUIRE:POINTS?` returns the automatically set record length.

Each predefined record length corresponds to a maximum number of history segments, which are stored in the instrument's memory. If option R&S RTM-K15 is installed, you can display the history segments.

Available record length values are:

- 5 | 10 | 20 | 50 | 100 | 200 | 500 kSample

- 1 | 2 | 5 | 10 | 20 | 40 | 80 MSample

Parameters:

<RecordLength> Record length in Samples.
If the entered value differs from the predefined values, the instrument sets the closest value.

CHANnel<m>:TYPE <DecimationMode>

Selects the method to reduce the data stream of the ADC to a stream of waveform points with lower sample rate.

Suffix:

<m> 1..4
The command affects all channels regardless of the indicated channel number. The suffix can be omitted.

Parameters:

<DecimationMode> SAMPlE | PDEtECT | HRESolution

SAMPlE

Input data is acquired with a sample rate which is aligned to the time base (horizontal scale) and the record length.

PDEtECT

Peak Detect: the minimum and the maximum of n samples in a sample interval are recorded as waveform points.

HRESolution

High resolution: The average of n sample points is recorded as waveform point.

*RST: SAMPlE

CHANnel<m>:ARITHmetics <TrArith>

Selects the method to build the resulting waveform from several consecutive acquisitions of the signal.

Suffix:

<m> 1..4
The command affects all channels regardless of the indicated channel number. The suffix can be omitted.

Parameters:

<TrArith> OFF | ENVELOpe | AVERAge

OFF

The data of the current acquisition is recorded according to the decimation settings.

ENVELOpe

Detects the minimum and maximum values in an sample interval over a number of acquisitions.

AVERage

Calculates the average from the data of the current acquisition and a number of acquisitions before. The number of used acquisitions is set with [ACQUIRE: AVERage: COUNT](#).

*RST: OFF

ACQUIRE:PEAKdetect <PeakDetect>

Enables or disables the peak detect acquisition mode.

You can use this command alternatively to [CHANnel<m>: TYPE](#).

Parameters:

<PeakDetect> AUTO | OFF

*RST: OFF

ACQUIRE:HRESolution <HighRes>

Enables or disables the high resolution acquisition mode.

You can use this command alternatively to [CHANnel<m>: TYPE](#).

Parameters:

<HighRes> AUTO | OFF

*RST: OFF

ACQUIRE:NSINGLE:COUNT <NSingleCount>

Sets the number of waveforms acquired with [RUNSingle](#).

Parameters:

<NSingleCount> Number of waveforms.

Range: 1 to maximum number that depends on the record length.

*RST: 1

ACQUIRE:AVERage:COUNT

Defines the number of waveforms used to calculate the average waveform. The higher the number, the better the noise is reduced.

Parameters:

<AverageCount> Range: 2 to 100,000

*RST: 2

ACQUIRE:AVERage:RESet

Deletes the waveform and restarts the average calculation.

Usage: Event

ACQUIRE:AVERage:COMPLete?

Returns the state of averaging.

Return values:

<AverageComplete> 0 | 1

0

The number of acquired waveforms is less than the number required for average calculation. See [ACQUIRE:AVERage:COUNT](#) on page 433.

1

The instrument acquired a sufficient number of waveforms to determine the average.

Usage: Query only

TIMEbase:ROLL:AUTomatic <AutomaticRoll>

Enables the automatic roll mode. The instrument switches to roll mode if the timebase is equal or slower than the roll mode limit defined with [TIMEbase:ROLL:MTIME](#).

Parameters:

<AutomaticRoll> ON | OFF
*RST: OFF

TIMEbase:ROLL:MTIME <MinTimeBase>

The roll mode is enabled automatically if the time base exceeds the `MinTimeBase`, and if [TIMEbase:ROLL:AUTomatic](#) on page 434 is set ON.

Parameters:

<MinTimeBase> Limit value for roll mode enabling.
*RST: 500e-3
Default unit: s/div

ACQUIRE:INTerpolate <InterpolationType>

Defines the interpolation mode.

See also: "[Interpolation](#)" on page 69

Parameters:

<InterpolationType> SINX | LINear | SMHD

LINear

Linear interpolation between two adjacent sample points.

SINX

Interpolation by means of a $\sin(x)/x$ curve.

SMHD

Sample & hold causes a histogram-like interpolation.

*RST: SINX

ACQUIRE:POINTS:ARATE?

Retrieves the sample rate of the ADC, that is the number of points that are sampled by the ADC in one second.

Return values:

<ACDsampleRate> ADC sample rate
Default unit: Hz

Usage: Query only

ACQUIRE:SRATE? <SampleRate>

Returns the sample rate, that is the number of recorded waveform samples per second.

Parameters:

<SampleRate> Default unit: Sa/s

Usage: Query only

16.4.8 Waveform Data

Use the following commands are described in [Chapter 16.9.1.2, "Analog Channels"](#), on page 541:

- [FORMat \[:DATA\]](#) on page 539
- [CHANnel<m>:DATA?](#) on page 541
- [CHANnel<m>:DATA:HEADer?](#) on page 542
- [CHANnel<m>:DATA:POINTs](#) on page 542
- [CHANnel<m>:DATA:ENVELOpe?](#) on page 543
- [CHANnel<m>:DATA:ENVELOpe:HEADer?](#) on page 544
- [CHANnel<m>:DATA:XINCrement?](#) on page 549
- [CHANnel<m>:DATA:XORigin?](#) on page 548
- [CHANnel<m>:DATA:YINCrement?](#) on page 550
- [CHANnel<m>:DATA:YORigin?](#) on page 549
- [CHANnel<m>:DATA:YRESolution?](#) on page 550
- [CHANnel<m>:DATA:ENVELOpe:XINCrement?](#) on page 549
- [CHANnel<m>:DATA:ENVELOpe:XORigin?](#) on page 548
- [CHANnel<m>:DATA:ENVELOpe:YINCrement?](#) on page 550
- [CHANnel<m>:DATA:ENVELOpe:YORigin?](#) on page 549
- [CHANnel<m>:DATA:ENVELOpe:YRESolution?](#) on page 550

16.5 Trigger

• General Trigger Settings.....	436
• Edge Trigger.....	438
• Edge A/B Trigger.....	440
• Width Trigger.....	441
• Video/TV Trigger.....	443
• Pattern Trigger.....	444
• Runt Trigger.....	447
• Risettime Trigger.....	448
• Timeout Trigger.....	450
• Serial Bus.....	451

16.5.1 General Trigger Settings

This section describes general trigger commands that are independent of the trigger type.

TRIGger:A:MODE.....	436
TRIGger:A:SOURce.....	436
TRIGger:A:TYPE.....	437
TRIGger:A:HOLDoff:MODE.....	437
TRIGger:A:HOLDoff:TIME.....	438

TRIGger:A:MODE <TriggerMode>

Sets the trigger mode. The trigger mode determines the behavior of the instrument if no trigger occurs.

Parameters:

<TriggerMode> AUTO | NORMal

AUTO

The instrument triggers repeatedly after a time interval if the trigger conditions are not fulfilled. If a real trigger occurs, it takes precedence.

NORMal

The instrument acquires a waveform only if a trigger occurs.

*RST: AUTO

TRIGger:A:SOURce <Source>

Sets the trigger source for the selected A trigger type.

Parameters:

<Source> CH1 | CH2 | CH3 | CH4 | EXTernalalog | LINE | SBUS1 |
SBUS2 | D0..D15

CH1 | CH2 | CH3 | CH4

One of the analog input channels is the trigger source. Available channels depend on the instrument type.

EXTErnanalog

External trigger input on the front panel

LINE

AC power supply line for the line trigger

SBUS1 | SBUS2

Serial bus 1 or 2

Requires at least one protocol option for serial bus (R&S RTM-K1 to K3)

D0..D15

Digital channels D0 to D15, can be used as trigger sources for edge, width, timeout and pattern trigger. Require MSO option R&S RTM-B1.

TRIGger:A:TYPE <Type>

Sets the trigger typer.

Parameters:

<Type> EDGE | WIDTHh | TV | BUS | LOGic | LINE | RISetime | RUNT

EDGE

Edge trigger

WIDTHh

Width trigger

TV

Video trigger

BUS

Requires at least one protocol option for serial bus (R&S RTM-K1 to K3)

LOGic

Pattern trigger, logic trigger

LINE

Trigger on power supply line

RISetime

Trigger on rise and fall time (transition trigger)

RUNT

Trigger on runts, on pulses with smaller amplitude

TRIGger:A:HOLDoff:MODE <HoldOffMode>

Enables or disables the holdoff time.

Parameters:

<HoldOffMode> TIME | OFF

*RST: Off

TRIGger:A:HOLDoff:TIME <HoldOffTime>

Defines the holdoff time. The next trigger occurs only after the holdoff time has passed.

Parameters:

<HoldOffTime> Default unit: s

16.5.2 Edge Trigger

TRIGger:A:EDGE:SLOPe.....	438
TRIGger:A:LEVel<n>[:VALue].....	438
TRIGger:A:FINDlevel.....	438
TRIGger:A:EDGE:COUPling.....	439
TRIGger:A:HYSteresis.....	439
TRIGger:A:LEVel<n>:HYSteresis.....	439
TRIGger:A:EDGE:FILTer:HFReject.....	439
TRIGger:A:EDGE:FILTer:NREJect.....	440

TRIGger:A:EDGE:SLOPe <Slope>

Sets the slope for the edge trigger.

Parameters:

<Slope> POSitive | NEGative | EITHer

POSitive

Rising edge, a positive voltage change

NEGative

Falling edge, a negative voltage change

EITHer

The rising as well as the falling edge

*RST: POSitive

TRIGger:A:LEVel<n>[:VALue] <Level>

Sets the trigger threshold voltage for edge, width, and timeout trigger.

Suffix:

<n> 1..5
Selects the trigger input. 1..4 select the corresponding analog channel, 5 is the external trigger input. The number of channels depends on the instrument.

Parameters:

<Level> Range: Depends on vertical scale.
Default unit: V

TRIGger:A:FINDlevel

Sets the trigger level to 50% of the signal amplitude.

Usage: Event

TRIGger:A:EDGE:COUPLing <Coupling>

Sets the coupling for the trigger source.

Parameters:

<Coupling> DC | AC | LFReject

DC

Direct current coupling. The trigger signal remains unchanged.

AC

Alternating current coupling. A highpass filter removes the DC offset voltage from the trigger signal.

LFReject

Sets the trigger coupling to high frequency. A 15 kHz highpass filter removes lower frequencies from the trigger signal. Use this mode only with very high frequency signals.

*RST: DC

TRIGger:A:HYSTeresis <Hysteresis>

Sets a hysteresis range around the trigger level. Hysteresis avoids unwanted trigger events caused by noise oscillation around the trigger level. The automatic, small, medium, large hysteresis values depend on the vertical scale.

On instruments with 1 GHz bandwidth, you can also set the hysteresis to user-defined values using [TRIGger:A:LEVel<n>:HYSTeresis](#).

Parameters:

<Hysteresis> AUTO | SMAL | MEDium | LARGE

*RST: AUTO

TRIGger:A:LEVel<n>:HYSTeresis <LevelHysteresis>

Sets the hysteresis value for the trigger level on instruments with 1 GHz bandwidth.

Parameters:

<LevelHysteresis> Default unit: DIV

TRIGger:A:EDGE:FILTer:HFReject <State>

Enables or disables an additional 5 kHz lowpass filter in the trigger path. This filter removes higher frequencies and is available with AC and DC coupling.

To filter out higher frequencies, you can use either this command or [TRIGger:A:EDGE:FILTer:NREJect](#).

Parameters:

<State> ON | OFF
 *RST: OFF

TRIGger:A:EDGE:FILTer:NREJect <State>

Turns an additional 100 MHz lowpass filter in the trigger path on or off. This filter removes higher frequencies and is available with AC and DC coupling.

To filter out higher frequencies, you can use either this command or [TRIGger:A:EDGE:FILTer:HFReject](#).

Parameters:

<State> ON | OFF
 *RST: OFF

16.5.3 Edge A/B Trigger

TRIGger:B:ENABle	440
TRIGger:B:SOURce	440
TRIGger:B:EDGE:SLOPe	441
TRIGger:B:MODE	441
TRIGger:B:DELaY	441
TRIGger:B:EVENT:COUNT	441

TRIGger:B:ENABle <State>

Activates the B-trigger.

Parameters:

<State> ON | OFF
 *RST: OFF

TRIGger:B:SOURce <Source>

Sets the source of the B-trigger.

Parameters:

<Source> CH1 | CH2 | CH3 | CH4 | D0 ... D15

CH1 | CH2 | CH3 | CH4

Analog input channels. Available channels depend on the instrument type.

D0..D15

Digital channels D0 to D15. Require MSO option R&S RTM-B1.

*RST: CH1

TRIGger:B:EDGE:SLOPe <Slope>

Sets the slope of the B-trigger.

Parameters:

<Slope>	POSitive NEGative EITHER
*RST:	POSitive

TRIGger:B:MODE <Mode>

Sets a time delay or event delay for the B-trigger. The instrument waits for that delay after an A-trigger until it recognizes the B-trigger.

Parameters:

<Mode>	DELaY EVENts
DELaY	Time delay. Set the time with TRIGger:B:DELaY .
EVENts	Event delay. Set the number of events with TRIGger:B:EVENt:COUNt .
*RST:	DELaY

TRIGger:B:DELaY <DelayTime>

Sets the time the instrument waits until it checks the B-trigger condition.

Parameters:

<DelayTime>	Range:	20e-9 to 6,871946854
	Increment:	Depends on the <DelayTime> value. The longer the time, the higher the increment.
	*RST:	20e-9
	Default unit:	s

TRIGger:B:EVENt:COUNt EventCount

Sets a number of B-trigger events that fulfill the B-trigger condition but do not cause the trigger. The oscilloscope triggers on the n-th event, the last of the specified number of events.

Parameters:

EventCount	Range:	1 to 65535
	Increment:	1
	*RST:	1

16.5.4 Width Trigger

To set the trigger level (threshold), use:

- [TRIGger:A:LEVel<n>\[:VALue\]](#) on page 438

CHANnel<m>:THReshold on page 421	
• TRIGger:A:FINDlevel on page 438	
CHANnel<m>:THReshold:FINDlevel on page 422	
• CHANnel<m>:THReshold:HYSTeresis on page 422	
TRIGger:A:WIDTh:POLarity.....	442
TRIGger:A:WIDTh:RANGe.....	442
TRIGger:A:WIDTh:WIDTh.....	442
TRIGger:A:WIDTh:DELTA.....	443

TRIGger:A:WIDTh:POLarity <Polarity>

Sets the polarity of the pulse.

Parameters:

<Polarity> POSitive | NEGative

POSitive

Positive going pulse, the width is defined from the rising to the falling slopes.

NEGative

Negative going pulse, the width is defined from the falling to the rising slopes.

*RST: POSitive

TRIGger:A:WIDTh:RANGe <RangeMode>

Defines how the measured pulse width is compared with the given limits.

Parameters:

<RangeMode> WITHin | OUTSide | SHORter | LONGer

WITHin | OUTSide

Triggers on pulses inside or outside a range defined by *time ± delta*. The time is specified with `TRIGger:A:WIDTh:WIDTh`, the range around is defined with `TRIGger:A:WIDTh:DELTA`. To trigger on an exact value ("Width =" or "Width ≠", set the range to 0 ("Variation", `TRIGger:A:WIDTh:DELTA`).

SHORter | LONGer

Triggers on pulses shorter or longer than a time set with `TRIGger:A:WIDTh:WIDTh`.

*RST: LONGer

TRIGger:A:WIDTh:WIDTh <Time1>

For the ranges WITHin and OUTSide (defined using `TRIGger:A:WIDTh:RANGe`), the <Time1> defines the center of a range which is defined by the limits \pm <Delta> (set with `TRIGger:A:WIDTh:DELTA`).

For the ranges SHORter and LONGer, the width defines the maximum and minimum pulse width, respectively.

Parameters:

<Time1> Center value, maximum value or minimum value depending on the defined range type.
 Range: 20E-9 to 6.87194685440
 Increment: Depends on the <Time1> value
 *RST: 20E-9

TRIGger:A:WIDTH:DELTA <Delta>

Defines a variation range around the width value specified using [TRIGger:A:WIDTH:WIDTH](#).

Parameters:

<Delta> Variation $\pm\Delta t$
 Range: Minimum is 0. Maximum depends on the defined pulse width (TRIG:A:WIDTH:WIDTh).

16.5.5 Video/TV Trigger

TRIGger:A:TV:STANdard	443
TRIGger:A:TV:POLarity	443
TRIGger:A:TV:FIELD	444
TRIGger:A:TV:LINE	444

TRIGger:A:TV:STANdard <Standard>

Selects the color television standard.

Parameters:

<Standard> PAL | NTSC | SECam | PALM | I576 | P720 | P1080 | I1080
 PALM = PAL-M
 I576 = SDTV 576i (PAL and SECAM)
 P720 | P1080 = HDTV 720/1080p (progressive scanning)
 I1080 = HDTV 1080i (interlaced scanning)
 *RST: PAL

TRIGger:A:TV:POLarity <Polarity>

Selects the polarity of the signal. Note that the sync pulse has the opposite polarity. The edges of the sync pulses are used for triggering,

See also: "[Signal](#)" on page 84

Parameters:

<Polarity> POSitive | NEGative

POSitive

If the video modulation is positive, the sync pulses are negative.

NEGative

If the modulation is negative, sync pulses are positive.

*RST: NEGative

TRIGger:A:TV:FIELD <Field>

Sets the trigger on the beginning of the video signal fields, or on the beginning of video signal lines.

Parameters:

<Field> EVEN | ODD | ALL | LINE | ALINE

EVEN | ODD

Triggers only on the field start of even or odd fields. Only available for interlaced scanning.

ALL

All fields, triggers on the frame start (progressive scanning) or any field start (interlaced scanning).

LINE

Triggers on the beginning of a specified line in any field. The line number is set with [TRIGger:A:TV:LINE](#).

ALINE

Triggers on the beginning of all video signal lines.

*RST: ALL

TRIGger:A:TV:LINE <Line>

Sets an exact line number if [TRIGger:A:TV:FIELD](#) is set to LINE.

Parameters:

<Line> Range: 1 to 525 (NTSC, PAL-M); 625 (PAL, SECAM, SDTV I-576); 750 (HDTV P720); 1125 (HDTV I1080, HDTV P1080)

Increment: 1

*RST: 1

16.5.6 Pattern Trigger

- [Pattern Definition](#).....444
- [Time Limitation](#).....446

16.5.6.1 Pattern Definition

TRIGger:A:PATtern:SOURce	445
TRIGger:A:PATtern:FUNCTion	445
TRIGger:A:PATtern:CONDition	445

TRIGger:A:PATtern:SOURce <SourceString>

Sets the state for each channel.

Parameters:

<SourceString> String containing 0, 1, or X for each channel.

1: high, the signal voltage is higher than the trigger level.
 0: low, the signal voltage is lower than the trigger level.
 X: Don't care. the channel does not affect the trigger.
 Without MSO option R&S RTM-B1, the pattern has 4 or 2 bits, depending on the number of channels: <C1><C2>[<C3><C4>].
 With MSO option, the pattern has 20 or 18 bits:
 <C1><C2>[<C3><C4>]<D0><D1><D2>...<D15>.

Example:

Without MSO option:

```
TRIG:A:PATT:SOUR "1X10"
```

C1 and C3 is set to high, C4 to low, and C2 does not matter (don't care).

Example:

With MSO option:

```
TRIG:A:PATT:SOUR "XXXX111101010011XXXX"
```

Analog channels C1 to C4 do not matter (don't care). Digital channels D0 to D11 are set to high or low, D12 to D15 do not matter.

TRIGger:A:PATtern:FUNCTion <Function>

Sets the logical combination of the channel states .

Parameters:

<Function> AND | OR

AND
 The required states of all channels must appear in the input signal at the same time.

OR
 At least one of the channels must have the required state.

*RST: AND

TRIGger:A:PATtern:CONDition <ConditionString>

Defines whether the instrument triggers on fulfillment of the logical condition, or on violation.

Parameters:

<ConditionString> ""TRUE"" | ""FALSE""

String parameter

*RST: ""TRUE""

16.5.6.2 Time Limitation

TRIGger:A:PATtern:MODE.....	446
TRIGger:A:PATtern:WIDTh:RANGe.....	446
TRIGger:A:PATtern:WIDTh[:WIDTh].....	446
TRIGger:A:PATtern:WIDTh:DELTA.....	447

TRIGger:A:PATtern:MODE <PatternMode>

Disables the time limitation or sets the time comparison mode.

Parameters:

<PatternMode> OFF | TIMEout | WIDTh

OFF

Disables the time limitation.

TIMEout

Defines how long at least the result of the state pattern condition must be true or false.

WIDTh

Defines a time range for keeping up the true result of the pattern condition. The range is defined using [TRIGger:A:PATtern:WIDTh:RANGe](#).

TRIGger:A:PATtern:WIDTh:RANGe <PatternRange>

Selects how the time limit for the pattern condition is defined.

The time is specified using [TRIGger:A:PATtern:WIDTh\[:WIDTh\]](#), the range around is specified using [TRIGger:A:PATtern:WIDTh:DELTA](#).

Parameters:

<PatternRange> WITHin | OUTSide | SHORter | LONGer

WITHin

Triggers if the pattern condition remains unchanged longer than *Time - Delta* and shorter than *Time + Delta*.

OUTSide

Triggers if the pattern condition remains unchanged either shorter than *Time - Delta* or longer than *Time + Delta*.

SHORter | LONGer

Triggers if the pattern condition changes before or after the specified time.

TRIGger:A:PATtern:WIDTh[:WIDTh] <PatternWidth>

For the ranges WITHin and OUTSide, the <PatternWidth> defines the center of a range which is defined by the limits \pm <Delta>.

For the ranges SHORter and LONGer, the pattern width defines the maximum and minimum values, respectively.

Parameters:

<PatternWidth> Default unit: s

TRIGger:A:PATtern:WIDTh:DELTA <PatternDelta>

Defines a range around the pattern width value specified using `TRIGger:A:PATtern:WIDTh[:WIDTh]`.

Parameters:

<PatternDelta> Default unit: s

16.5.7 Runt Trigger

<code>TRIGger:A:LEVel<n>:RUNT:LOWer</code>	447
<code>TRIGger:A:LEVel<n>:RUNT:UPPer</code>	447
<code>TRIGger:A:RUNT:DELTA</code>	447
<code>TRIGger:A:RUNT:POLarity</code>	448
<code>TRIGger:A:RUNT:RANGe</code>	448
<code>TRIGger:A:RUNT:WIDTh</code>	448

TRIGger:A:LEVel<n>:RUNT:LOWer <Level>

Sets the lower voltage threshold for runt detection. A positive runt crosses the lower level twice without crossing the upper level.

Suffix:

<n> 1..5

Parameters:

<Level>

TRIGger:A:LEVel<n>:RUNT:UPPer <Level>

Sets the upper voltage threshold for runt detection. A negative runt crosses the upper level twice without crossing the lower level.

Suffix:

<n> 1..5

Parameters:

<Level>

TRIGger:A:RUNT:DELTA <Variation>

Sets a range Δt to the reference pulse width set with `TRIGger:A:RUNT:WIDTh`, if `TRIGger:A:RUNT:RANGe` is set to `WITHin` or `OUTSide`.

Parameters:

<Variation> Range: Depends on various settings, mainly time base and sample rate

TRIGger:A:RUNT:POLarity <Polarity>

Indicates the polarity of a the runt to be triggered on.

Parameters:

<Polarity> POSitive | NEGative
*RST: POS

TRIGger:A:RUNT:RANGe <Range>

Sets how the measured pulse width is compared with the given limit(s).

To set the width, use [TRIGger:A:RUNT:WIDTh](#).

To set the range $\pm \Delta t$, use [TRIGger:A:RUNT:DELTA](#).

Parameters:

<Range> LONGer | SHORter | WITHin | OUTSide

LONGer
Finds pulses longer than the given width.

SHORter
Finds pulses shorter than the given width.

WITHin
Finds pulses inside the range *width* $\pm \Delta t$.

OUTSide
Finds pulses outside the range *width* $\pm \Delta t$.

*RST: LONG

TRIGger:A:RUNT:WIDTh <Width>

Sets the reference runt pulse width, the nominal value for comparisons.

Parameters:

<Width> Range: Depends on various settings, mainly time base and sample rate

16.5.8 Risetime Trigger

TRIGger:A:LEVel<n>:RISetime:LOWer	448
TRIGger:A:LEVel<n>:RISetime:UPPer	449
TRIGger:A:RISetime:DELTA	449
TRIGger:A:RISetime:RANGe	449
TRIGger:A:RISetime:SLOPe	449
TRIGger:A:RISetime:TIME	450

TRIGger:A:LEVel<n>:RISetime:LOWer <Level>

Sets the lower voltage threshold. When the signal crosses this level, the rise time measurement starts or stops depending on the selected slope.

Suffix:

<n> 1..5

Parameters:

<Level>

TRIGger:A:LEVel<n>:RISetime:UPPer <Level>

Sets the upper voltage threshold. When the signal crosses this level, the rise/fall time measurement starts or stops depending on the selected slope.

Suffix:

<n> 1..5

Parameters:

<Level>

TRIGger:A:RISetime:DELTA <Variation>

Sets a range Δt to the reference rise/fall time set with `TRIGger:A:RISetime:TIME`, if `TRIGger:A:RISetime:RANGe` is set to `WithIn` or `OutSide`. The instrument triggers on rise/fall times inside or outside the range $time \pm \Delta t$.

Parameters:

<Variation>

TRIGger:A:RISetime:RANGe <Range>

Sets how the measured rise or fall time is compared with the given limit(s).

To set the rise/fall time, use `TRIGger:A:RISetime:TIME`.

To set the range $\pm \Delta t$, use `TRIGger:A:RISetime:DELTA`.

Parameters:

<Range> LONGer | SHORter | WITHin | OUTSide

LONGer

Triggers on rise/fall times longer than the given time.

SHORter

Triggers on rise/fall times shorter than the given time.

WITHinTriggers on rise/fall times inside the range $time \pm \Delta t$.**OUTSide**Triggers on rise/fall times outside the range $time \pm \Delta t$.

*RST: LONG

TRIGger:A:RISetime:SLOPe <Polarity>

Sets the edge of the slope to be triggered on.

Parameters:

<Polarity> POSitive | NEGative
 POSitive: rise time trigger
 NEGative: fall time trigger
 *RST: POS

TRIGger:A:RISetime:TIME <RiseTime>

Sets the reference rise or fall time, the nominal value for comparisons.

Parameters:

<RiseTime> Depends on various settings, mainly time base and sample rate

16.5.9 Timeout Trigger

To set the trigger level (threshold), use:

- [TRIGger:A:LEVel<n>\[:VALue\]](#) on page 438
[CHANnel<m>:THReshold](#) on page 421
- [TRIGger:A:FINDlevel](#) on page 438
[CHANnel<m>:THReshold:FINDlevel](#) on page 422
- [CHANnel<m>:THReshold:HYSTeresis](#) on page 422

[TRIGger:A:TIMEout:RANGe](#)..... 450
[TRIGger:A:TIMEout:TIME](#)..... 450

TRIGger:A:TIMEout:RANGe <Range>

Sets the relation of the signal level to the threshold.

Parameters:

<Range> HIGH | LOW
 HIGH
 The signal level stays above the trigger level.
 LOW
 The signal level stays below the trigger level.
 *RST: HIGH

TRIGger:A:TIMEout:TIME <Time>

Sets the time limit for the timeout at which the instrument triggers.

Parameters:

<Time> Range: 6.4e-9 to 13.7439
 *RST: 10e-6

16.5.10 Serial Bus

Triggering on the decoded data of a protocol bus is available if at least one serial protocol option is installed. The serial bus must be configured correctly. For detailed information on serial protocols and their trigger conditions, see the chapter of the relevant protocol.

16.6 Waveform Analysis

• Zoom	451
• Mathematics	452
• Reference Waveforms	456
• Search	460
• History (Option R&S RTM-K15)	476

16.6.1 Zoom

TIMEbase:ZOOM:STATe	451
TIMEbase:ZOOM:SCALE	451
TIMEbase:ZOOM:TIME	451
TIMEbase:ZOOM:POSition	452
DISPlay:CBAR:ZOOM[:POSition]	452

TIMEbase:ZOOM:STATe <ZoomState>

Switches the zoom on or off.

Parameters:

<ZoomState>	ON OFF
*RST:	OFF

TIMEbase:ZOOM:SCALE <ZoomScale>

Defines the horizontal scale for the zoom window in seconds per division, the timebase of the zoom window. The scaling determines the width of the zoom area (12 divisions * scaling per division).

Parameters:

<ZoomScale>	Range:	Depends on various settings
	*RST:	50e-6
	Default unit:	s/div

TIMEbase:ZOOM:TIME <Time>

Defines the distance of the trigger point to the reference point in the zoom window. The value determines the position of the zoom area that is displayed in the zoom window.

Parameters:

<Time> *RST: 0
Default unit: s

TIMEbase:ZOOM:POSition <Position>

Defines the position of the zoom window in the upper window.

Parameters:

<Position> Range: Depends on the zoom time base, from nearly 0 to 100 % for large zoom.
*RST: 50
Default unit: %

DISPlay:CBAR:ZOOM[:POSition] <DividerPosition>

Defines the position of the divide bar between normal waveform and zoom window.

Parameters:

<DividerPosition> Vertical position in pixel, measured from the top edge. The vertical display size is 800 px.
Default unit: px

16.6.2 Mathematics

To get the data of a math waveform, use the following commands:

- [CALCulate:MATH<m>:DATA?](#) on page 545
- [CALCulate:MATH<m>:DATA:HEADer?](#) on page 545
- [CALCulate:MATH<m>:DATA:POINts?](#) on page 545
- [CALCulate:MATH<m>:DATA:XORigin?](#) on page 548
- [CALCulate:MATH<m>:DATA:XINCrement?](#) on page 549
- [CALCulate:MATH<m>:DATA:YORigin?](#) on page 549
- [CALCulate:MATH<m>:DATA:YINCrement?](#) on page 550
- [CALCulate:MATH<m>:DATA:YRESolution?](#) on page 550

CALCulate:MATH<m>:STATe	453
CALCulate:MATH<m>[:EXPReSSion][:DEFine]	453
CALCulate:MATH<m>:LABel	454
CALCulate:MATH<m>:LABel:STATe	454
CALCulate:MATH<m>:POSition	455
CALCulate:MATH<m>:SCALE	455
CALCulate:MATH<m>:WCOLor	455
CALCulate:MATH<m>:TRACk:EDGE	455
CALCulate:MATH<m>:TRACk:DPULse[:ENABle]	456
CALCulate:MATH<m>:TRACk:THReshold:HYSTeresis	456
CALCulate:MATH<m>:TRACk:THReshold[:UPPer]	456
CALCulate:MATH<m>:TRACk:THReshold:LOWer	456

CALCulate:MATH<m>:STATe <State>

Activates the mathematics function and displays the defined math waveforms.

Suffix:

<m> 1..5
Selects the math waveform.

Parameters:

<State> ON | OFF
*RST: OFF

CALCulate:MATH<m>[:EXPRession][:DEFine] <RemComplExpr>

Defines the equation to be calculated for the selected math waveform as a regular expression.

Suffix:

<m> 1..5
Selects the math waveform.

Parameters:

<RemComplExpr> String parameter, consisting of the mathematical operation and the source(s), written in parenthesis. Optionally, the unit can be included in the string. If no unit is given, the last setting is used.

Example:

CALC:MATH<2>:EXPR:DEF "ADD(CH1,CH2) "

Same command with unit:

CALC:MATH<2>:EXPR:DEF "ADD(CH1,CH2) in V"

Delete the unit:

CALC:MATH<2>:EXPR:DEF "ADD(CH1,CH2) in "

Operation	Expression string	Comment
Addition	"ADD(CH1,CH2) in V"	"CH1+CH2" is also possible
Subtraction	"SUB(CH1,CH2) in V"	"CH1-CH2" is also possible
Multiplication	"MUL(CH1,CH2)"	"CH1*CH2" is also possible
Division	"DIV(CH1,CH2)"	"CH1/CH2" is also possible
Square	"SQR(CH1)"	
Square Root	"SQRT(CH1)"	
Absolute value	"ABS(CH1)"	
Reciprocal	"REC(CH1)"	
Inverse	"INV(CH1)"	
Common logarithm (basis 10)	"LOG(CH1)"	
Natural logarithm (basis e)	"LN(CH1)"	
Derivative	"DERI(CH1)"	
Integral	"INT(CH1)"	

Operation	Expression string	Comment
Low pass filter	"LP(CH1,1E6) in V"	CH1 – Source waveform
High pass filter	"HP(CH1,1E6) in V"	1E6 – constant value, limit frequency of the low or high pass
FFT	"FFTMAG(CH1)"	FFT function of the source waveform
Track period (unipolar)	"TPER(CH1)"	Set the threshold, hysteresis and edge with: <code>CALCulate:MATH<m>:TRACk:THReshold[:UPPer]</code> <code>CALCulate:MATH<m>:TRACk:THReshold:HYSteresis</code> <code>CALCulate:MATH<m>:TRACk:EDGE</code> See also: Chapter 6.2.6, "Tracks" , on page 102
Track frequency (unipolar)	"TFREQ(CH1)"	
Track pulse width (unipolar)	"TPW(CH1)"	
Track duty cycle (unipolar)	"TDCY(CH1)"	
Track period (bipolar)	"TPERB(CH1)"	Set the thresholds, hysteresis and edge with: <code>CALCulate:MATH<m>:TRACk:THReshold:LOWer</code> <code>CALCulate:MATH<m>:TRACk:THReshold[:UPPer]</code> <code>CALCulate:MATH<m>:TRACk:THReshold:HYSteresis</code> <code>CALCulate:MATH<m>:TRACk:EDGE</code> See also: Chapter 6.2.6, "Tracks" , on page 102
Track frequency (bipolar)	"TFREQB(CH1)"	
Track pulse width (bipolar)	"TPWB(CH1)"	
Track duty cycle (bipolar)	"TDCYB(CH1)"	

CALCulate:MATH<m>:LABel <Label>

Defines a label for the specified math waveform (equation), which is shown at the waveform.

Suffix:

<m> 1..5
Selects the math waveform.

Parameters:

<Label> String Data
String with label text

CALCulate:MATH<m>:LABel:STATe <LabelVisible>

Activates the display of the label that is defined with `CALCulate:MATH<m>:LABel`.

Suffix:

<m> 1..5
Selects the math waveform.

Parameters:

<LabelVisible> ON | OFF

CALCulate:MATH<m>:POSition <Position>

Sets the vertical position of the math waveform.

Suffix:

<m> 1..5
Selects the math waveform.

Parameters:

<Position> Position value, given in divisions.

CALCulate:MATH<m>:SCALE <Scale>

Sets the vertical scale of the math waveform.

Suffix:

<m> 1..5
Selects the math waveform.

Parameters:

<Scale> Scale value, given in Volts per division

CALCulate:MATH<m>:WCOLor <WaveformColor>

Sets the color of the indicated math waveform.

Suffix:

<m> 1..5

Parameters:

<WaveformColor> YELLow | GREen | ORANge | BLUE | LBLUE | WHITE | CYAN |
PINK | RED | TEMPerature | RAINbow | FIRE | DEFault
*RST: DEF

CALCulate:MATH<m>:TRACk:EDGE <Polarity>

Sets the rising or falling edge as a reference for each measurement. The setting helps to determine values in terms of the power stage switching state.

For unipolar sources, the on edge is the rising edge, and the off edge is the falling edge.

In the bipolar case, all transitions are inverted for the negative branch. For positive pulses, the rising edge is the on edge, and for negative pulses, the falling edge is the on edge.

Suffix:

<m> 1..5

Parameters:

<Polarity> ON | OFF

CALCulate:MATH<m>:TRACk:DPULse[:ENABLE] <DoublePulseEnable>

Available for bipolar signals. Considers the effect of the double pulse, which arises due to the inversion.

Suffix:

<m> 1..5

Parameters:

<DoublePulseEnable>ON | OFF

CALCulate:MATH<m>:TRACk:THReshold:HYSTeresis <Hysteresis>

Sets the hysteresis for correct edge detection.

Suffix:

<m> 1..5

Parameters:

<Hysteresis> Default unit: V

CALCulate:MATH<m>:TRACk:THReshold[:UPPer] <ThresholdLevel>

Sets the threshold for unipolar track sources, or the upper level for bipolar sources. The signal is measured at the crossing points of the signal with the threshold.

Suffix:

<m> 1..5

Parameters:

<ThresholdLevel> Default unit: V

CALCulate:MATH<m>:TRACk:THReshold:LOWer <ThresholdLevel>

Sets the lower level for bipolar track sources, which determines the crossing points on negative pulses.

Suffix:

<m> 1..5

Parameters:

<ThresholdLevel> Default unit: V

16.6.3 Reference Waveforms

In all REFCurve:... commands, the suffix <m> selects the reference waveform.

To get the waveform data, use the following commands:

- [REFCurve<m>:DATA?](#) on page 546
- [REFCurve<m>:DATA:HEADer?](#) on page 546
- [REFCurve<m>:DATA:XINCrement?](#) on page 549

- [REFCurve<m>:DATA:XORigin?](#) on page 548
- [REFCurve<m>:DATA:YINCrement?](#) on page 550
- [REFCurve<m>:DATA:YORigin?](#) on page 549
- [REFCurve<m>:DATA:YRESolution?](#) on page 550

REFCurve<m>:SOURce	457
REFCurve<m>:SOURce:CATalog?	457
REFCurve<m>:STATe	458
REFCurve<m>:UPDate	458
REFCurve<m>:SAVE	458
REFCurve<m>:LOAD	458
REFCurve<m>:LOAD:STATe	459
REFCurve<m>:HORizontal:POSition	459
REFCurve<m>:HORizontal:SCALe	459
REFCurve<m>:VERTical:POSition	459
REFCurve<m>:VERTical:SCALe	460
REFCurve<m>:WCOLor	460
REFCurve<m>:LABel	460

REFCurve<m>:SOURce <Source>

Defines the source of the reference waveform.

Suffix:

<m> 1..4
Selects the reference waveform

Parameters:

<Source> CH1 | CH2 | CH3 | CH4 | MA1 | MA2 | MA3 | MA4 | MA5 | RE1 | RE2 | RE3 | RE4 | D70 | D158 | SPEC | MINH | MAXH | AVER

CH1 | CH2 | CH3 | CH4 | MA1 | MA2 | MA3 | MA4 | MA5 | RE1 | RE2 | RE3 | RE4
Any active channel, math, or reference waveform. CH3 and CH4 are only available with 4-channel R&S RTM3000 oscilloscopes.

D70 | D158
Logic probes, sources require MSO option R&S RTM-B1.

SPEC | MINH | MAXH | AVER
FFT waveforms: spectrum, min hold, max hold, average.

*RST: CH1

REFCurve<m>:SOURce:CATalog?

Returns the source waveform.

Suffix:

<m> 1..4
Selects the reference waveform.

Parameters:

<Source Catalogue> CH1 | CH2 | CH3 | CH4 | QMA | RE1 | RE2 | RE3 | RE4 | D70 | D158 | SPEC | MINH | MAXH | AVER

See [REFCurve<m>:SOURCE](#) on page 457.

Usage: Query only

REFCurve<m>:STATE

Displays or hides the selected reference waveform.

Suffix:

<m> 1..4
Selects the reference waveform.

Parameters:

<State> ON | OFF
*RST: OFF

REFCurve<m>:UPDATE

Updates the selected reference by the waveform defined with [REFCurve<m>:SOURCE](#).

Suffix:

<m> 1..4
Selects the reference waveform.

Usage: Event

REFCurve<m>:SAVE <Filename>

Stores the reference waveform in the specified file.

Suffix:

<m> 1..4
Selects the reference waveform.

Setting parameters:

<Filename> String with path and file name

Usage: Setting only

REFCurve<m>:LOAD <Filename>

Loads the waveform data from the indicated reference file to the reference waveform.

To load the correspondent instrument settings, use [REFCurve<m>:LOAD:STATE](#) on page 459.

Suffix:

<m> 1..4
Selects the reference waveform.

Setting parameters:

<Filename> String with path and file name

Usage: Setting only

REFCurve<m>:LOAD:STATE

Loads the instrument settings in addition to the reference waveform data. The waveform data must be loaded before the settings, see [REFCurve<m>:LOAD](#) on page 458.

The settings are only available if the file was stored to the internal storage and never written to a USB flash device.

Suffix:

<m> 1..4
Selects the reference waveform.

Usage: Event

REFCurve<m>:HORizontal:POSition <Position>

Changes the horizontal position of the reference waveform independently of the channel waveform settings.

Suffix:

<m> 1..4
Selects the reference waveform.

Parameters:

<Position> Default unit: s

REFCurve<m>:HORizontal:SCALE <Scale>

Changes the horizontal scale (timebase) of the reference waveform independently of the channel waveform settings.

Suffix:

<m> 1..4
Selects the reference waveform.

Parameters:

<Scale> Default unit: s/div

REFCurve<m>:VERTical:POSition <Position>

Changes the vertical position of the reference waveform.

Suffix:

<m> 1..4
Selects the reference waveform.

Parameters:

<Position> Default unit: div

REFCurve<m>:VERTical:SCALE <Scale>

Changes the vertical scale of the reference waveform.

Suffix:

<m> 1..4
Selects the reference waveform.

Parameters:

<Scale> Default unit: V/div

REFCurve<m>:WCOLor <WaveformColor>

Selects a color for the reference waveform. The default color is white. You can select another monochrome color, or a color scale.

Suffix:

<m> 1..4
Selects the reference waveform.

Parameters:

<WaveformColor> YELLOW | GREEN | ORANGE | BLUE | LBLUE | WHITE | CYAN |
PINK | RED | TEMPERATURE | RAINBOW | FIRE | DEFAULT
*RST: DEF

REFCurve<m>:LABEL <WaveformLabel>

Defines a label for the indicated reference waveform.

Suffix:

<m> 1..4
Selects the reference waveform.

Parameters:

<WaveformLabel> String parameter
String parameter

Example:

REFCurve2:LABEL "Origin"
Sets the label "Origin" for reference R2.

16.6.4 Search

- [General Search Settings](#).....461
- [Edge Search Configuration](#).....462
- [Width Search Configuration](#).....463
- [Peak Search Configuration](#).....465
- [Rise/Fall Time Search Configuration](#).....465
- [Runt Search Configuration](#).....467
- [Data2Clock Search Configuration](#).....468

- [Pattern Search Configuration](#).....470
- [Window Search Configuration](#).....472
- [Search Results](#).....474

16.6.4.1 General Search Settings

SEARch:STATe	461
SEARch:CONDition	461
SEARch:SOURce	462

SEARch:STATe <SearchState>

Enables and disables the search mode.

Parameters:

<SearchState> ON | OFF
 *RST: OFF

Example: [Chapter 16.2.3.1, "Searching for a Pulse of Specified Width"](#),
 on page 410

SEARch:CONDition <SearchCondition>

Parameters:

<SearchCondition> EDGE | WIDTH | PEAK | RUNT | RTIME | DATatoclock |
 PATTern | PROTocol | WINDow

EDGE

An edge search result is found when the waveform passes the given level in the specified direction.

WIDTH

A width search finds pulses with an exact pulse width, or pulses shorter or longer than a given time, or pulses inside or outside the allowable time range.

PEAK

The peak search finds pulses exceeding a given amplitude.

RUNT

The runt search finds pulses lower than normal in amplitude. The amplitude crosses the first threshold twice without crossing the second one. In addition to the threshold amplitudes, you can define a time limit for the runt in the same way as for width search: runts with exact width, shorter or longer than a given time, or runts inside or outside the allowable time range.

RTIME

The rise or fall time search finds slopes with an exact rise or fall time, or rise/fall times shorter or longer than a given limit, or rise/fall times inside or outside the allowable time range.

DATatoclock

The Data2Clock search - also known as setup/hold - finds violation of setup and hold times. It analyzes the relative timing between two signals: a data signal and the synchronous clock signal. Setup time is the time that the data signal is steady before clock edge. Hold time is the time that the data signal is steady after clock edge.

PATtern

The pattern search finds logical combinations of channel states inside or outside a specified time range. For each channel, its state and threshold level is defined. The states are combined logically, and the time of true pattern results is compared with a specified time range.

PROTocol

The protocol search finds various events in decoded data of signals, for example, a specified frame type, identifier, data, and errors. Available search settings depend on the configured bus type.

Protocol search is not available for bus types PARallel, I2C, SPI (no CS), SPI (with CS), UART, and I2S (Audio).

WINDow

The window search finds violations of a window that is formed by the upper and lower voltage levels. An event occurs if the waveform enters or leaves the window, or if the waveform stays inside or outside for a time longer or shorter than specified, or if the waveform passes both levels in a given time.

*RST: EDGE

SEARch:SOURce <SearchSource>

Selects the waveform to be analyzed.

Parameters:

<SearchSource> CH1 | CH2 | CH3 | CH4 | QMA | RE1 | RE2 | RE3 | RE4

Any active channel, math, or reference waveform can be searched.

For protocol search on CAN and LIN signals, an active serial bus is the search source.

*RST: CH1

Example: [Chapter 16.2.3.1, "Searching for a Pulse of Specified Width", on page 410](#)

16.6.4.2 Edge Search Configuration

SEARch:TRIGger:EDGE:SLOPe.....	463
SEARch:TRIGger:EDGE:LEVel.....	463
SEARch:TRIGger:EDGE:LEVel:DELTA.....	463

SEARch:TRIGger:EDGE:SLOPe <Slope>

Sets the slope to be searched for.

Parameters:

<Slope> POSitive | NEGative | EITHER
*RST: POS

SEARch:TRIGger:EDGE:LEVel <Level>

Sets the voltage level for the edge search.

Parameters:

<Level> *RST: 0.5 V

SEARch:TRIGger:EDGE:LEVel:DELTA <DeltaLevel>

Sets a hysteresis range above and below the search level to avoid unwanted search results caused by noise oscillation around the level.

Parameters:

<DeltaLevel> Range: Lower limit depends on vertical scale and other settings, no upper limit
*RST: 0.2 V

16.6.4.3 Width Search Configuration

SEARch:TRIGger:WIDTh:POLarity.....	463
SEARch:TRIGger:WIDTh:LEVel.....	463
SEARch:TRIGger:WIDTh:LEVel:DELTA.....	464
SEARch:TRIGger:WIDTh:RANGe.....	464
SEARch:TRIGger:WIDTh:WIDTh.....	464
SEARch:TRIGger:WIDTh:DELTA.....	464

SEARch:TRIGger:WIDTh:POLarity <Polarity>

Indicates the polarity of the pulse to be searched for.

Parameters:

<Polarity> POSitive | NEGative
*RST: POS

Example:

[Chapter 16.2.3.1, "Searching for a Pulse of Specified Width",](#)
on page 410

SEARch:TRIGger:WIDTh:LEVel <Level>

Sets the voltage level on which the pulse width is measured.

Parameters:

<Level> *RST: 500 mV

SEARch:TRIGger:WIDTh:LEVel:DELTA <DeltaLevel>

Sets a hysteresis range above and below the search level to avoid unwanted search results caused by noise oscillation around the level.

Parameters:

<DeltaLevel>	Range:	Lower limit depends on vertical scale and other settings, no upper limit
	*RST:	200 mV

SEARch:TRIGger:WIDTh:RANGe <Range>

Sets how the measured pulse width is compared with the given limit(s).

To set the width, use [SEARch:TRIGger:WIDTh:WIDTh](#).

To set the range $\pm \Delta t$, use [SEARch:TRIGger:WIDTh:DELTA](#).

Parameters:

<Range>	WITHin OUTSide SHORter LONGer
---------	-------------------------------------

WITHin
Finds pulses inside the range $width \pm \Delta t$.

OUTSide
Finds pulses outside the range $width \pm \Delta t$.

SHORter
Finds pulses shorter than the given width.

LONGer
Finds pulses longer than the given width.

*RST:	WITH
-------	------

Example: [Chapter 16.2.3.1, "Searching for a Pulse of Specified Width"](#), on page 410

SEARch:TRIGger:WIDTh:WIDTh <Width>

Sets the reference pulse width, the nominal value for comparisons.

Parameters:

<Width>	Default unit: s
---------	-----------------

Example: [Chapter 16.2.3.1, "Searching for a Pulse of Specified Width"](#), on page 410

SEARch:TRIGger:WIDTh:DELTA <DeltaWidth>

Sets a range Δt to the reference pulse width set with [SEARch:TRIGger:WIDTh:WIDTh](#), if [SEARch:TRIGger:WIDTh:RANGe](#) is set to WITHin or OUTSide.

Parameters:

<DeltaWidth>	Range:	Lower limit depends on the resolution, practically no upper limit
--------------	--------	---

Example: Chapter 16.2.3.1, "Searching for a Pulse of Specified Width", on page 410

16.6.4.4 Peak Search Configuration

SEARch:MEASure:PEAK:POLarity.....	465
SEARch:MEASure:LEVel:PEAK:MAGNitude.....	465

SEARch:MEASure:PEAK:POLarity <Polarity>

Indicates the polarity of a the pulse to be searched for a peak.

Parameters:

<Polarity> POSitive | NEGative | EITHer
 *RST: POS

SEARch:MEASure:LEVel:PEAK:MAGNitude <Magnitude>

Sets the peak-to-peak limit. If the signal exceeds this limit, a search event is listed.

Parameters:

<Magnitude> Default unit: V

16.6.4.5 Rise/Fall Time Search Configuration

SEARch:TRIGger:RISetime:SLOPe.....	465
SEARch:TRIGger:LEVel:RISetime:LOWer.....	465
SEARch:TRIGger:LEVel:RISetime:UPPer.....	466
SEARch:TRIGger:RISetime:RANGe.....	466
SEARch:TRIGger:RISetime:TIME.....	466
SEARch:TRIGger:RISetime:DELTA.....	466

SEARch:TRIGger:RISetime:SLOPe <Polarity>

Sets the slope to be found.

Parameters:

<Polarity> POSitive | NEGative | EITHer
 POSitive: to search for rise time.
 NEGative: to search for fall time.
 EITHer: to search for rise and fall time.
 *RST: POS

SEARch:TRIGger:LEVel:RISetime:LOWer <LowerLevel>

Sets the lower voltage threshold. When the signal crosses this level, the rise time measurement starts or stops depending on the selected slope.

Parameters:

<DeltaTime> Range: Depends on various settings, mainly time base and sample rate
 *RST: 50e-6
 Default unit: s

16.6.4.6 Runt Search Configuration

SEARch:TRIGger:RUNT:POLarity.....	467
SEARch:TRIGger:LEVel:RUNT:LOWer.....	467
SEARch:TRIGger:LEVel:RUNT:UPPer.....	467
SEARch:TRIGger:RUNT:RANGe.....	467
SEARch:TRIGger:RUNT:WIDTh.....	468
SEARch:TRIGger:RUNT:DELTA.....	468

SEARch:TRIGger:RUNT:POLarity <Polarity>

Indicates the polarity of a the runt to be searched for.

Parameters:

<Polarity> POSitive | NEGative | EITHer
 *RST: POS

SEARch:TRIGger:LEVel:RUNT:LOWer <LowerLevel>

Sets the lower voltage threshold for runt detection. A positive runt crosses the lower level twice without crossing the upper level.

Parameters:

<LowerLevel> Range: Depends on vertical scale and LSB value.
 *RST: 400 mV
 Default unit: V

SEARch:TRIGger:LEVel:RUNT:UPPer <UpperLevel>

Sets the upper voltage threshold for runt detection. A negative runt crosses the upper level twice without crossing the lower level.

Parameters:

<UpperLevel> Range: Depends on vertical scale and LSB value.
 *RST: 600 mV
 Default unit: V

SEARch:TRIGger:RUNT:RANGe <Range>

Sets how the measured pulse width is compared with the given limit(s).

To set the width, use [SEARch:TRIGger:RUNT:WIDTh](#).

To set the range $\pm \Delta t$, use `SEARch:TRIGger:RUNT:DELTA`.

Parameters:

<Range> LONGer | SHORter | WITHin | OUTSide

LONGer
Finds pulses longer than the given width.

SHORter
Finds pulses shorter than the given width.

WITHin
Finds pulses inside the range $width \pm \Delta t$.

OUTSide
Finds pulses outside the range $width \pm \Delta t$.

*RST: LONG

SEARch:TRIGger:RUNT:WIDTH <Width>

Sets the reference runt pulse width, the nominal value for comparisons.

Parameters:

<Width> Range: Depends on various settings, mainly time base and sample rate.

*RST: 200e-6

Default unit: s

SEARch:TRIGger:RUNT:DELTA <DeltaWidth>

Sets a range Δt to the reference pulse width set with `SEARch:TRIGger:RUNT:WIDTH`, if `SEARch:TRIGger:RUNT:RANGE` is set to `WITHin` or `OUTSide`.

Parameters:

<DeltaWidth> Range: Depends on various settings, mainly time base and sample rate.

*RST: 50e-6

Default unit: s

16.6.4.7 Data2Clock Search Configuration

<code>SEARch:TRIGger:DATatoclock:CSource</code>	468
<code>SEARch:TRIGger:DATatoclock:CLeVel</code>	469
<code>SEARch:TRIGger:DATatoclock:DLeVel</code>	469
<code>SEARch:TRIGger:DATatoclock:CLeVel:DELTA</code>	469
<code>SEARch:TRIGger:DATatoclock:DLeVel:DELTA</code>	469
<code>SEARch:TRIGger:DATatoclock:CEdGe</code>	469
<code>SEARch:TRIGger:DATatoclock:HTime</code>	469
<code>SEARch:TRIGger:DATatoclock:STime</code>	470

SEARch:TRIGger:DATatoclock:CSource <ClockSource>

Selects the input channel of the clock signal.

Parameters:

<ClockSource> CH1 | CH2 | CH3 | CH4
 *RST: CH1

SEARCh:TRIGger:DATatoclock:CLeVel <ClockLevel>

Sets the voltage level for the clock signal. The crossing of clock level and clock edge defines the start point for setup and hold time.

Parameters:

<ClockLevel> Range: Depends on vertical scale

SEARCh:TRIGger:DATatoclock:DLeVel <DataLevel>

Sets the voltage level for the data signal. The data level defines the threshold for data transition.

Parameters:

<DataLevel> Range: Depends on vertical scale

SEARCh:TRIGger:DATatoclock:CLeVel:DELTA <LevelDelta>**SEARCh:TRIGger:DATatoclock:DLeVel:DELTA <LevelDelta>**

Set a hysteresis range to the clock and data levels in order to avoid unwanted search results caused by noise oscillation around the level.

Parameters:

<LevelDelta> Range: Lower limit depends on vertical scale and other settings, no upper limit

SEARCh:TRIGger:DATatoclock:CEdGe <ClockEdge>

Sets the edge of the clock signal to define the start point for the setup and hold time.

Parameters:

<ClockEdge> POSitive | NEGative | EITHer
 *RST: POS

SEARCh:TRIGger:DATatoclock:HTIME <HoldTime>

Sets the minimum time **after** the clock edge while the data signal must stay steady above or below the data level. The hold time can be negative. In this case, the hold time ends before the clock edge, and the setup time must be positive and longer than the absolute value of the hold time.

Parameters:

<HoldTime> Range: Depends on time base and sample interval

SEARch:TRIGger:DATatoclock:STIme <SetupTime>

Sets the minimum time **before** the clock edge while the data signal must stay steady above or below the data level. The setup time can be negative. In this case, the setup interval starts after the clock edge, and the hold time must be positive and longer than the absolute value of the setup time.

Parameters:

<SetupTime> Range: Depends on time base and sample interval

16.6.4.8 Pattern Search Configuration

SEARch:TRIGger:PATtern:SOURce.....	470
SEARch:TRIGger:PATtern:FUNCTion.....	470
SEARch:TRIGger:PATtern:LEVel<n>.....	471
SEARch:TRIGger:PATtern:LEVel<n>:DELTA.....	471
SEARch:TRIGger:PATtern:WIDTh:RANGe.....	471
SEARch:TRIGger:PATtern:WIDTh[:WIDTh].....	472
SEARch:TRIGger:PATtern:WIDTh:DELTA.....	472

SEARch:TRIGger:PATtern:SOURce <Pattern>

Specifies the search pattern - the state for each channel. The state can be set only for active channels.

Parameters:

<Pattern> String parameter
 String containing 0, 1, X|x for each channel. The order of channels is fixed: CH1 CH2 [CH3 CH4] D0 D1 D2 D3 ...

Example:

```
CHAN1:STAT ON
CHAN2:STAT ON
CHAN3:STAT ON
CHAN4:STAT ON
SEAR:STAT ON
SEAR:COND PATT
SEAR:TRIG:PATT:SOUR '1X10'
```

CH1, CH3 are high, CH4 is low. These states are logically combined with `SEARch:TRIGger:PATtern:FUNCTion`. CH2 does not matter (don't care) and can be off.

SEARch:TRIGger:PATtern:FUNCTion <Function>

Sets the logical combination of the channel states.

Parameters:

<Function> AND | OR | NAND | NOR

AND

The required states of all channels must appear in the input signal at the same time.

OR

At least one of the channels must have the required state.

NAND

"Not and" operator, at least one of the channels does not have the required state.

NOR

"Not or" operator, none of the channels has the required state.

*RST: AND

SEARCh:TRIGger:PATtern:LEVel<n> <ThresholdLevel>

Sets the threshold value for the specified source channel. You can set different levels for the channels

Suffix:

<n> 1..4
Selects the input channel. The number of channels depends on the instrument.

Parameters:

<ThresholdLevel> Range: Depends on vertical scale

SEARCh:TRIGger:PATtern:LEVel<n>:DELTA <LevelDelta>

Sets a hysteresis range to the threshold of the specified source channel to avoid unwanted search results caused by noise oscillation around the level.

Suffix:

<n> 1..4
Selects the input channel. The number of channels depends on the instrument.

Parameters:

<LevelDelta> Range: Lower limit depends on vertical scale and other settings, no upper limit

SEARCh:TRIGger:PATtern:WIDTh:RANGe <Range>

Sets the condition how the duration of a steady pattern is compared with the given reference time.

To set the reference value *width*, use `SEARCh:TRIGger:PATtern:WIDTh[:WIDTh]`.

To set a range Δt , use `SEARCh:TRIGger:PATtern:WIDTh:DELTA`

Parameters:

<Range> WITHin | OUTSide | LONGer | SHORter

WITHin

Finds patterns steady for a time range $width \pm \Delta t$.

OUTSide

Finds patterns outside a time range $width \pm \Delta t$.

LONGer

Finds patterns steady for at least the given *width*.

SHORTer

Finds patterns shorter than the given *width*.

*RST: LONG

SEARch:TRIGger:PATtern:WIDTh[:WIDTh] <Width>

Sets the reference time of a steady pattern, the nominal value for comparisons.

Parameters:

<Width> Default unit: s

SEARch:TRIGger:PATtern:WIDTh:DELTA <DeltaTime>

Sets a range Δt to the reference pattern duration set with `SEARch:TRIGger:PATtern:WIDTh[:WIDTh]`, if `SEARch:TRIGger:PATtern:WIDTh:RANGE` is set to `WITHin` or `OUTSide`.

Parameters:

<DeltaTime> Default unit: s

16.6.4.9 Window Search Configuration

<code>SEARch:TRIGger:LEVel:WINDow:LOWer</code>	472
<code>SEARch:TRIGger:LEVel:WINDow:UPPer</code>	472
<code>SEARch:TRIGger:WINDow:DELTA</code>	472
<code>SEARch:TRIGger:WINDow:POLarity</code>	473
<code>SEARch:TRIGger:WINDow:RANGE</code>	473
<code>SEARch:TRIGger:WINDow:TIMerange</code>	473
<code>SEARch:TRIGger:WINDow:WIDTh</code>	474

SEARch:TRIGger:LEVel:WINDow:LOWer <LowerLevel>**SEARch:TRIGger:LEVel:WINDow:UPPer <UpperLevel>**

Set the lower and upper voltage limits for the window.

Parameters:

<UpperLevel> *RST: 0.4

SEARch:TRIGger:WINDow:DELTA <DeltaWidth>

Defines a range around the width value (see `SEARch:TRIGger:WINDow:DELTA`).

Parameters:

<DeltaWidth> *RST: 100e-6

SEARch:TRIGger:WINDow:POLarity <Polarity>

Indicates the polarity of the pulse to be searched for.

Parameters:

<Polarity> POSitive | NEGative | EITHer
*RST: EITH

SEARch:TRIGger:WINDow:RANGe <RangeMode>

Selects how the signal run is compared with the window.

Parameters:

<RangeMode> ENTer | EXIT | WITHin | OUTSide | PASSthrough |
NPASsthrough

ENTer

Triggers when the signal crosses the upper or lower level and thus enters the window made up of these two levels.

EXIT

Triggers when the signal leaves the window.

WITHin

Triggers if the signal stays between the upper and lower level for a specified time. The time is defined in various ways by the [SEARch:TRIGger:WINDow:TIMerange](#) command.

OUTSide

Triggers if the signal stays above the upper level or below the lower level for a specified time. The time is also defined by the [SEARch:TRIGger:WINDow:TIMerange](#) command.

*RST: ENT

SEARch:TRIGger:WINDow:TIMerange <TimeRange>

Selects how the time limit of the window is defined. Time conditioning is available for the vertical conditions **WITHin** and **OUTSide** (see [SEARch:TRIGger:WINDow:RANGe](#)).

Parameters:

<TimeRange> WITHin | OUTSide | SHORter | LONGer

WITHin

Triggers if the signal stays inside or outside the vertical window limits at least for the time *Width - Delta* and for *Width + Delta* at the most.

OUTSide

"Outside" is the opposite definition of "Within". The instrument triggers if the signal stays inside or outside the vertical window limits for a time shorter than *Width - Delta* or longer than *Width + Delta*.

SHORTer

Triggers if the signal crosses vertical limits before the specified "Width" time is reached.

LONGer

Triggers if the signal crosses vertical limits before the specified "Width" time is reached.

*RST: LONG

SEARch:TRIGger:WINDow:WIDTh <Width>

Sets the reference pulse width, the nominal value for comparisons.

Parameters:

<Width> *RST: 400e-6

16.6.4.10 Search Results

SEARch:RESult:BCOunt?.....	474
SEARch:RESDiagram:SHOW.....	474
SEARch:RESult:ALL?.....	475
SEARch:RESult<n>?.....	475
SEARch:RCOunt?.....	476
EXPort:SEARch:NAME.....	476
EXPort:SEARch:SAVE.....	476

SEARch:RESult:BCOunt?

Returns the maximum number of search results, which the instrument can store.

Return values:

<BufferedCount> Maximum number of search results

Usage: Query only

SEARch:RESDiagram:SHOW <ResultShow>

Shows or hides the table of search results.

Parameters:

<ResultShow> ON | OFF
*RST: OFF

Example: [Chapter 16.2.3.1, "Searching for a Pulse of Specified Width", on page 410](#)

SEARCh:RESult:ALL?

Returns all result values of the search.

Return values:

<AllResults> List of results items separated by comma
 For each result, six values are returned:
 1. Result number as indicated in the search results table
 2. X-position (time) of the search result
 3. Y-position of the search result, currently not relevant
 4. Type of the search result (Edge, Peak, ...)
 5. Slope or polarity of the search result
 6. For peak searches, the value contains the peak voltage. For width searches, it contains the pulse width. For edge searches, the value is not relevant.

Example:

SEARCh:RESult:ALL?

Returns all four results of a peak search:

```
1, -4.7750e-04, 0, PEAK, NEGATIVE, -1.530e-02, 2,
-4.4630e-04, 0, PEAK, NEGATIVE, -1.530e-02, 3,
-4.1660e-04, 0, PEAK, NEGATIVE, -1.530e-02, 4,
-3.8690e-04, 0, PEAK, NEGATIVE, -1.530e-02
```

Example:

[Chapter 16.2.3.1, "Searching for a Pulse of Specified Width"](#), on page 410

Usage:

Query only

SEARCh:RESult<n>?

Returns the result values of the specified search result.

See also: [SEARCh:RESult:ALL?](#)

Suffix:

<n> *
 Number of the search result

Return values:

<Result> Comma-separated value list
 Meaning of the values:
 Result number, time value, y-position (not relevant), search type, slope or polarity, optional value: voltage for peak search, pulse width for width search.

Example:

SEARCh:RESult3?

Returns the result values of the third search result.

```
3, -4.1660e-04, 0, PEAK, NEGATIVE, -1.530e-02
```

Usage:

Query only

SEARch:RCOut?

Returns the number of search results.

Return values:

<ResultCount> *RST: 0

Example: [Chapter 16.2.3.1, "Searching for a Pulse of Specified Width"](#),
on page 410

Usage: Query only

EXPort:SEARch:NAME <FileName>

Defines the path and filename for search results that will be saved with [EXPort:SEARch:SAVE](#). The file format is CSV, the filename is incremented automatically.

You can change the file name manually in the [Search] > "Save" dialog. Remote control uses the recent settings.

Parameters:

<FileName> String parameter

Example: `EXPort:SEARch:NAME "/USB_FRONT/SEARCH/RESULT"`
On first save, the search results are saved to RESULT.CSV, on
second save to RESULT01.CSV, the third to RESULT02.CSV ...

EXPort:SEARch:SAVE

Saves the search results to the path and file defined by [EXPort:SEARch:NAME](#).

Usage: Setting only

16.6.5 History (Option R&S RTM-K15)

- [History Settings](#)..... 476
- [Displaying History Segments](#)..... 479
- [Timestamps](#)..... 482
- [Export of History Data](#)..... 486

16.6.5.1 History Settings

ACQuire:MEMory[:MODE] <MemoryMode>

Defines how the record length is set.

Parameters:

<MemoryMode> AUTomatic | DMEMory | MANual
AUTomatic
Automatically by the instrument

DMEMory

Predefined values are set with `ACQUIRE:POINTS[:VALUE]`

MANual

User-defined value is set with `ACQUIRE:POINTS[:VALUE]`.

The number of available history segments is adjusted automatically.

*RST: AUT

ACQUIRE:POINTS:AUTomatic <AutoRecordLength>

Enables or disables the automatic record length. The instrument sets a value that fits to the selected timebase.

If you set a specific value with `ACQUIRE:POINTS[:VALUE]`, the automatic assignment of a record length is turned off.

Parameters:

<AutoRecordLength> ON | OFF

Example:

```
ACQ:POIN:AUT ON
TIM:SCAL 1e-9
ACQ:POIN?::SYST:ERR:ALL?
-> received 10000;0,"No error"
TIM:SCAL 5e-3
ACQ:POIN?::SYST:ERR:ALL?
-> received 20000000;0,"No error"
```

ACQUIRE:POINTS[:VALUE]

Defines a record length value, the number of recorded waveform points in a segment.

The command turns `ACQUIRE:POINTS:AUTomatic` OFF.

If `ACQUIRE:POINTS:AUTomatic` is turned ON, the query `ACQUIRE:POINTS?` returns the automatically set record length.

Each predefined record length corresponds to a maximum number of history segments, which are stored in the instrument's memory. If option R&S RTM-K15 is installed, you can display the history segments.

Available record length values are:

- 5 | 10 | 20 | 50 | 100 | 200 | 500 kSample
- 1 | 2 | 5 | 10 | 20 | 40 | 80 MSample

Parameters:

<RecordLength> Record length in Samples.
If the entered value differs from the predefined values, the instrument sets the closest value.

ACQUIRE:COUNT

Sets the number of segments to be captured.

In automatic mode, the command is a query and returns the maximum number of segments that can be captured with the current configuration. See also: [ACQUIRE:MEMORY\[:MODE\]](#)

Parameters:

<NoOfAcquisitions> Number of available segments in the memory

ACQUIRE:NSINGLE:COUNT <NSingleCount>

Sets the number of waveforms acquired with [RUNSINGLE](#).

Parameters:

<NSingleCount> Number of waveforms.
Range: 1 to maximum number that depends on the record length.
*RST: 1

ACQUIRE:AVAILABLE?

Returns the number of segments that are currently saved in the memory. This number is available for history viewing.

Parameters:

<Acquisitions> Number of captured segments

Usage: Query only

ACQUIRE:SEGMENTED:STATE <State>

If ON, the acquisitions are performed as fast as possible, without processing and displaying the waveforms. When acquisition has been stopped, the data is processed and the latest waveform is displayed. Older waveforms are stored in segments. You can display and analyze the segments using the history..

Parameters:

<State> ON | OFF

ACQUIRE:AVERAGE:CURRENT?

Returns the current amount of acquired waveforms that contribute to the average. The value is independent of the number of available segments, there are more waveforms in the average available than segments in history.

Parameters:

<CurrentAverages> Range: Minimum is 2; maximum depends on the instrument settings.

Usage: Query only

16.6.5.2 Displaying History Segments

The commands in this chapter use numeric suffixes:

- CHANnel<m>: Selects the analog input channel.
- MATH<m>: Selects the math waveform, range 1..4
- DIGital<m>: Selects the logic channel, range 0..15
- LOGic<p>: Selects the logic pod, range 1..2
- BUS: Selects the bus, range 1..4

CALCulate:MATH<m>:HISTory:CONTRol:ENABle]	480
BUS:HISTory:CONTRol:ENABle]	480
DIGital<m>:HISTory:CONTRol:ENABle]	480
LOGic<p>:HISTory:CONTRol:ENABle]	480
CHANnel<m>:HISTory:CONTRol:[ENABle]	480
CALCulate:MATH<m>:HISTory:CURRent	480
BUS:HISTory:CURRent	480
DIGital<m>:HISTory:CURRent	480
LOGic<p>:HISTory:CURRent	480
SPECtrum:HISTory:CURRent	480
CHANnel<m>:HISTory:CURRent	480
CALCulate:MATH<m>:HISTory:PALL	480
BUS:HISTory:PALL	480
DIGital<m>:HISTory:PALL	480
LOGic<p>:HISTory:PALL	480
SPECtrum:HISTory:PALL	480
CHANnel<m>:HISTory:PALL	480
CALCulate:MATH<m>:HISTory:STARt	481
BUS:HISTory:STARt	481
DIGital<m>:HISTory:STARt	481
LOGic<p>:HISTory:STARt	481
SPECtrum:HISTory:STARt	481
CHANnel<m>:HISTory:STARt	481
CALCulate:MATH<m>:HISTory:STOP	481
BUS:HISTory:STOP	481
DIGital<m>:HISTory:STOP	481
LOGic<p>:HISTory:STOP	481
SPECtrum:HISTory:STOP	481
CHANnel<m>:HISTory:STOP	481
CALCulate:MATH<m>:HISTory:PLAYer:SPEEd	481
BUS:HISTory:PLAYer:SPEEd	481
DIGital<m>:HISTory:PLAYer:SPEEd	481
LOGic<p>:HISTory:PLAYer:SPEEd	481
SPECtrum:HISTory:PLAYer:SPEEd	481
CHANnel<m>:HISTory:PLAYer:SPEEd	481
CALCulate:MATH<m>:HISTory:REPLay	481
BUS:HISTory:REPLay	481
DIGital<m>:HISTory:REPLay	481
LOGic<p>:HISTory:REPLay	482
SPECtrum:HISTory:REPLay	482

CHANnel<m>:HISTory:REPLay.....	482
CALCulate:MATH<m>:HISTory:PLAYer:STATe.....	482
BUS:HISTory:PLAYer:STATe.....	482
DIGital<m>:HISTory:PLAYer:STATe.....	482
LOGic<p>:HISTory:PLAYer:STATe.....	482
SPECtrum:HISTory:PLAYer:STATe.....	482
CHANnel<m>:HISTory:PLAYer:STATe.....	482

CALCulate:MATH<m>:HISTory:CONTRol:ENABle] <PlayerControlEnable>
BUS:HISTory:CONTRol:ENABle] <PlayerControlEnable>
DIGital<m>:HISTory:CONTRol:ENABle] <PlayerControlEnable>
LOGic<p>:HISTory:CONTRol:ENABle] <PlayerControlEnable>
CHANnel<m>:HISTory:CONTRol:[ENABle] <PlayerControl>

Displays or hides the history player on the screen.

Parameters:

<PlayerControl> ON | OFF
 *RST: OFF

CALCulate:MATH<m>:HISTory:CURRent <CurrentAcquisition>
BUS:HISTory:CURRent <CurrentAcquisition>
DIGital<m>:HISTory:CURRent <CurrentAcquisition>
LOGic<p>:HISTory:CURRent <CurrentAcquisition>
SPECtrum:HISTory:CURRent <CurrentAcquisition>
CHANnel<m>:HISTory:CURRent <CurrentAcquisition>

Accesses a particular history segment in the memory to display it. The query returns the index of the segment that is shown.

Parameters:

<CurrentAcquisition> Segment index. There are two ways to enter the index.
 Negative index count: the newest segment has the index "0",
 older segments have a negative index: -(n-1), -1 , 0
 Positive index count: the oldest segment has the index 1, and
 the newest segment has the index n: 1, 2,..., n
 where n is the number of acquired segments.

CALCulate:MATH<m>:HISTory:PALL <PlayAll>
BUS:HISTory:PALL <PlayAll>
DIGital<m>:HISTory:PALL <PlayAll>
LOGic<p>:HISTory:PALL <PlayAll>
SPECtrum:HISTory:PALL <PlayAll>
CHANnel<m>:HISTory:PALL <PlayAll>

Enables the replay of all acquired segments.

Parameters:**<PlayAll>** ON | OFF

If set to OFF, define the range of segments to be shown using [CHANnel<m>:HISTory:START](#) and [CHANnel<m>:HISTory:STOP](#)

***RST:** ON**CALCulate:MATH<m>:HISTory:START** <StartAcquisition>**BUS:HISTory:START** <StartAcquisition>**DIGital<m>:HISTory:START** <StartAcquisition>**LOGic<p>:HISTory:START** <StartAcquisition>**SPECtrum:HISTory:START** <StartAcquisition>**CHANnel<m>:HISTory:START** <StartAcquisition>

Sets the index of the oldest segment to be displayed.

Parameters:**<StartAcquisition>** Start index. You can enter a positive or negative index, see [CHANnel<m>:HISTory:CURRent](#) .**CALCulate:MATH<m>:HISTory:STOP** <StopAcquisition>**BUS:HISTory:STOP** <StopAcquisition>**DIGital<m>:HISTory:STOP** <StopAcquisition>**LOGic<p>:HISTory:STOP** <StopAcquisition>**SPECtrum:HISTory:STOP** <StopAcquisition>**CHANnel<m>:HISTory:STOP** <StopAcquisition>

Sets the index of the latest segment to be displayed.

Parameters:**<StopAcquisition>** Stop index. You can enter a positive or negative index, see [CHANnel<m>:HISTory:CURRent](#).**CALCulate:MATH<m>:HISTory:PLAYer:SPEEd** <PlayerSpeed>**BUS:HISTory:PLAYer:SPEEd** <PlayerSpeed>**DIGital<m>:HISTory:PLAYer:SPEEd** <PlayerSpeed>**LOGic<p>:HISTory:PLAYer:SPEEd** <PlayerSpeed>**SPECtrum:HISTory:PLAYer:SPEEd** <PlayerSpeed>**CHANnel<m>:HISTory:PLAYer:SPEEd** <PlayerSpeed>

Sets the speed of the history replay.

Parameters:**<PlayerSpeed>** SLOW | MEDium | FAST | AUTO***RST:** AUTO**CALCulate:MATH<m>:HISTory:REPLay** <Replay>**BUS:HISTory:REPLay** <Replay>**DIGital<m>:HISTory:REPLay** <Replay>

LOGic<p>:HISTory:REPLay <Replay>
SPECTrum:HISTory:REPLay <Replay>
CHANnel<m>:HISTory:REPLay <Replay>

If set to ON, the replay of the selected history segments repeats automatically.

Parameters:

<Replay> ON | OFF
 *RST: STOP

CALCulate:MATH<m>:HISTory:PLAYer:STATe <PlayerState>
BUS:HISTory:PLAYer:STATe <PlayerState>
DIGital<m>:HISTory:PLAYer:STATe <PlayerState>
LOGic<p>:HISTory:PLAYer:STATe <PlayerState>
SPECTrum:HISTory:PLAYer:STATe <PlayerState>
CHANnel<m>:HISTory:PLAYer:STATe <PlayerState>

Starts and stops the replay of the history segments.

Parameters:

<PlayerState> RUN | STOP
 *RST: STOP

16.6.5.3 Timestamps

You can query the timestamps of history segments in two ways:

- Query for the timestamps of all history segments using `...:HISTory:...:ALL` commands.
- Query for the timestamp of a specific segment using `...:HISTory:... com-`mands. Select the segment of interest using `CHANnel<m>:HISTory:CURRent` appropriate command.

The commands in this chapter use numeric suffixes:

- `CHANnel<m>`: Selects the analog input channel.
- `MATH<m>`: Selects the math waveform, range 1..4
- `DIGital<m>`: Selects the logic channel, range 0..15
- `LOGic<p>`: Selects the logic pod, range 1..2
- `BUS`: Selects the bus, range 1..4

<code>CALCulate:MATH<m>:HISTory:TTABLE[:ENABLE]</code>	483
<code>BUS:HISTory:TTABLE[:ENABLE]</code>	483
<code>DIGital<m>:HISTory:TTABLE[:ENABLE]</code>	483
<code>LOGic<p>:HISTory:TTABLE[:ENABLE]</code>	483
<code>CHANnel<m>:HISTory:TTABLE[:ENABLE]</code>	483
<code>CHANnel<m>:HISTory:TMODE</code>	484
<code>CALCulate:MATH<m>:HISTory:TSRelative?</code>	484
<code>BUS:HISTory:TSRelative?</code>	484
<code>DIGital<m>:HISTory:TSRelative?</code>	484
<code>LOGic<p>:HISTory:TSRelative?</code>	484

SPECTrum:HISTory:TSRelative?	484
CHANnel<m>:HISTory:TSRelative?	484
CALCulate:MATH<m>:HISTory:TSRelative:ALL?	484
BUS:HISTory:TSRelative:ALL?	484
DIGital<m>:HISTory:TSRelative:ALL?	484
LOGic<p>:HISTory:TSRelative:ALL?	484
SPECTrum:HISTory:TSRelative:ALL?	484
CHANnel<m>:HISTory:TSRelative:ALL?	484
CALCulate:MATH<m>:HISTory:TSABsolute?	485
BUS:HISTory:TSABsolute?	485
DIGital<m>:HISTory:TSABsolute?	485
LOGic<p>:HISTory:TSABsolute?	485
SPECTrum:HISTory:TSABsolute?	485
CHANnel<m>:HISTory:TSABsolute?	485
CALCulate:MATH<m>:HISTory:TSABsolute:ALL?	485
BUS:HISTory:TSABsolute:ALL?	485
DIGital<m>:HISTory:TSABsolute:ALL?	485
LOGic<p>:HISTory:TSABsolute:ALL?	485
SPECTrum:HISTory:TSABsolute:ALL?	485
CHANnel<m>:HISTory:TSABsolute:ALL?	485
CALCulate:MATH<m>:HISTory:TSDate?	485
BUS:HISTory:TSDate?	485
DIGital<m>:HISTory:TSDate?	485
LOGic<p>:HISTory:TSDate?	485
SPECTrum:HISTory:TSDate?	485
CHANnel<m>:HISTory:TSDate?	485
CALCulate:MATH<m>:HISTory:TSDate:ALL?	486
BUS:HISTory:TSDate:ALL?	486
DIGital<m>:HISTory:TSDate:ALL?	486
LOGic<p>:HISTory:TSDate:ALL?	486
SPECTrum:HISTory:TSDate:ALL?	486
CHANnel<m>:HISTory:TSDate:ALL?	486

CALCulate:MATH<m>:HISTory:TTABLE[:ENABLE] <TimeTableEnable>

BUS:HISTory:TTABLE[:ENABLE] <TimeTableEnable>

DIGital<m>:HISTory:TTABLE[:ENABLE] <TimeTableEnable>

LOGic<p>:HISTory:TTABLE[:ENABLE] <TimeTableEnable>

CHANnel<m>:HISTory:TTABLE[:ENABLE] <TimeTableEnable>

Displays or hides the segment table on the screen.

Parameters:

<TimeTableEnable> ON | OFF

*RST: OFF

CHANnel<m>:HISTory:TMODe <TableMode>

Returns the the type of the timestamp that is shown the segment table.

Parameters:

<TableMode> RELative | ABSolute

RELative

Time difference of the current segment to the newest segment (index = 0).

ABSolute

Date and daytime of the trigger event of the segments.

CALCulate:MATH<m>:HISTory:TSRelative?**BUS:HISTory:TSRelative?****DIGital<m>:HISTory:TSRelative?****LOGic<p>:HISTory:TSRelative?****SPECtrum:HISTory:TSRelative?****CHANnel<m>:HISTory:TSRelative?**

Returns the time difference of the selected segment to the newest segment. To select a segment, use [CHANnel<m>:HISTory:CURRent](#).

Return values:

<TimeToNewestAcq> Time to newest acquisition

Example:

```
CHAN:HIST:CURR -5
CHAN:HIST:TSR?
--> -1.138757760000E-02
```

Returns the relative time of the sixth segment. The newest segment has index 0.

Usage:

Query only

CALCulate:MATH<m>:HISTory:TSRelative:ALL?**BUS:HISTory:TSRelative:ALL?****DIGital<m>:HISTory:TSRelative:ALL?****LOGic<p>:HISTory:TSRelative:ALL?****SPECtrum:HISTory:TSRelative:ALL?****CHANnel<m>:HISTory:TSRelative:ALL?**

Returns the time differences to the newest acquisition of all history segments.

Return values:

<TimeToNewestAcq> List of Values

The list starts with the oldest segment, and the newest segment is the last one.

Example:

```
CHANnel2:HISTory:TSRelative:ALL?
--> -4.184565632000E-01,-4.094896352000E-01,-4.005227104000E-01,
-3.915557824000E-01, ..., -8.966924800000E-03,-0.000000000000E+00
```

Usage:

Query only

CALCulate:MATH<m>:HISTory:TSABsolute?
BUS:HISTory:TSABsolute?
DIGital<m>:HISTory:TSABsolute?
LOGic<p>:HISTory:TSABsolute?
SPECtrum:HISTory:TSABsolute?
CHANnel<m>:HISTory:TSABsolute?

Returns the absolute daytime of the selected acquisition (`CHANnel<m>:HISTory:CURRent`).

Return values:

<Hour>, <Minute>, Comma-separated list
<Seconds>

Example: `CHAN:HIST:CURR -1`
 `CHAN:HIST:TSAB?`
 `--> 16,24,3.302100000000E+01`

Usage: Query only

CALCulate:MATH<m>:HISTory:TSABsolute:ALL?
BUS:HISTory:TSABsolute:ALL?
DIGital<m>:HISTory:TSABsolute:ALL?
LOGic<p>:HISTory:TSABsolute:ALL?
SPECtrum:HISTory:TSABsolute:ALL?
CHANnel<m>:HISTory:TSABsolute:ALL?

Returns the absolute daytimes of all history segments.

Return values:

<Hour>, <Minute>, Comma-separated list of hour, minute, and second values.
<Second>

Example: `CHANnel2:HISTory:TSABsolute:ALL?`
 `--> 14,59,4.558154343680E+01,14,59,4.559051036480E+01,`
 `14,59,4.559947728960E+01,...`

Usage: Query only

CALCulate:MATH<m>:HISTory:TSDate?
BUS:HISTory:TSDate?
DIGital<m>:HISTory:TSDate?
LOGic<p>:HISTory:TSDate?
SPECtrum:HISTory:TSDate?
CHANnel<m>:HISTory:TSDate?

Returns the date of the selected acquisition (`CHANnel<m>:HISTory:CURRent`).

Return values:

<Year>, <Month>, Comma-separated list
<Day>

Example: CHAN:HIST:CURR -5
 CHAN:HIST:TSD?
 --> 2014,7,1

Usage: Query only

CALCulate:MATH<m>:HISTory:TSDate:ALL?
BUS:HISTory:TSDate:ALL?
DIGital<m>:HISTory:TSDate:ALL?
LOGic<p>:HISTory:TSDate:ALL?
SPECtrum:HISTory:TSDate:ALL?
CHANnel<m>:HISTory:TSDate:ALL?

Returns the dates of all history segments.

Return values:

<Year>, <Month>, <Day> Comma-separated list of year, month, and day values.
 The list starts with the oldest segment, and the newest segment is the last one.

Example: CHANnel12:HISTory:TSDate:ALL?
 --> 2014,11,26,2014,11,26,2014,11,26,2014,11,26,...

Usage: Query only

16.6.5.4 Export of History Data

The commands in this chapter use numeric suffixes:

- CHANnel<m>: Selects the analog input channel.
- MATH<m>: Selects the math waveform, range 1..4
- DIGital<m>: Selects the logic channel, range 0..15
- LOGic<p>: Selects the logic pod, range 1..2
- BUS: Selects the bus, range 1..4

BPLot:EXPort:NAME.....	486
BUS:HISTory:EXPort:NAME.....	486
DIGital<m>:HISTory:EXPort:NAME.....	486
SPECtrum:HISTory:EXPort:NAME.....	487
CHANnel<m>:HISTory:EXPort:NAME.....	487
EXPort:ATABLE:NAME.....	487
BPLot:EXPort:SAVE.....	487
BUS:HISTory:EXPort:SAVE.....	487
DIGital<m>:HISTory:EXPort:SAVE.....	487
SPECtrum:HISTory:EXPort:SAVE.....	487
CHANnel<m>:HISTory:EXPort:SAVE.....	487
EXPort:ATABLE:SAVE.....	487

BPLot:EXPort:NAME
BUS:HISTory:EXPort:NAME <ExportPath>
DIGital<m>:HISTory:EXPort:NAME <ExportPath>

SPECtrum:HISTory:EXPort:NAME <ExportPath>
CHANnel<m>:HISTory:EXPort:NAME <ExportPath>
EXPort:ATABle:NAME <ExportPath>

Parameters:

<ExportPath> String parameter

Example: `EXPort:ATABle:NAME "/USB_FRONT/EXPORT/TIMES"`

BPLot:EXPort:SAVE
BUS:HISTory:EXPort:SAVE
DIGital<m>:HISTory:EXPort:SAVE
SPECtrum:HISTory:EXPort:SAVE
CHANnel<m>:HISTory:EXPort:SAVE
EXPort:ATABle:SAVE

Saves the acquisition timestamps table to the file that is defined by the `EXPort:ATABle:NAME` command.

Example: `EXPort:ATABle:SAVE`

The file contains the following timestamp values:

```

", "Date", "Time"
"Start of Acquisition", "2014-11-24", "14:35:59"
"Last Acquisition", "2014-11-24", "14:36:01"
"Acquisitions", "150"

"Number", "Relative Time", "Time to previous",
"Date", "Time", "Trigger"
"0", "-0.000000000000000E+00", "1.009638400000000E-02",
"2014-11-24", "14:36:01", "0.00000000000E+00", Trg'd
"-1", "-1.009638400000000E-02", "2.000568800000000E-02",
"2014-11-24", "14:36:00", "9.8990361600E-01", Trg'd
"-2", "-3.010207200000000E-02", "2.000216800000000E-02",
"2014-11-24", "14:36:00", "9.6989792800E-01", Trg'd
"-3", "-5.010424000000000E-02", "2.001423200000000E-02",
"2014-11-24", "14:36:00", "9.4989576000E-01", Trg'd
"-4", "-7.011847200000000E-02", "2.000044000000000E-02",
"2014-11-24", "14:36:00", "9.2988152800E-01", Trg'd
"-5", "-9.011891200000001E-02", "9.917412000000000E-03",
"2014-11-24", "14:36:00", "9.0988108800E-01", Trg'd
"-6", "-1.000363240000000E-01", "1.009686000000000E-02",
"2014-11-24", "14:36:00", "8.9996367600E-01", Trg'd.....

```

Usage: Event

16.7 Measurements

16.7.1 Quick Measurements

In the quick measurement commands, the numeric suffix <m> is irrelevant, omit it.

MEASurement<m>:AON.....	488
MEASurement<m>:AOFF.....	488
MEASurement<m>:AREsult?.....	488
MEASurement<m>:ALL[:STATe].....	488

MEASurement<m>:AON

Starts the quick measurement.

Usage: Event

MEASurement<m>:AOFF

Stops the quick measurement.

Usage: Event

MEASurement<m>:AREsult?

Returns the results of the quick measurement.

Return values:

<Data> List of values
 Quick measurement results are listed in the following order:
 PEAK (Vpp), UPE (Vp+), LPE (Vp-), CYCR (RMS-Cyc), CYCM
 (MeanCyc), PER (T), FREQ (f), RTIM (tr), FTIM (tf).

Usage: Query only

MEASurement<m>:ALL[:STATe]

Starts or stops the quick measurement and sets the status bit.

Suffix:

<m> 1..8
 The suffix is irrelevant.

Parameters:

<State> ON | OFF
 *RST: OFF

16.7.2 Automatic Measurements

16.7.2.1 Measurement Settings

MEASurement<m>[:ENABLE].....	489
MEASurement<m>:MAIN.....	489
MEASurement<m>:SOURce.....	491
MEASurement<m>:DELay:SLOPe.....	492
MEASurement<m>:STATistics[:ENABLE].....	492
MEASurement<m>:STATistics:RESet.....	492

MEASurement<m>[:ENABLE] <State>

Activates or deactivates the selected measurement.

Suffix:

<m> 1..8
Selects the measurement place.

Parameters:

<State> ON | OFF
*RST: OFF

MEASurement<m>:MAIN <MeasType>

Defines the measurement type to be performed on the selected source. To query the results, use `MEASurement<m>:RESult[:ACTual]?`.

Suffix:

<m> 1..8
Selects the measurement.

Parameters:

<MeasType> FREQuency | PERiod | PEAK | UPEakvalue | LPEakvalue |
PPCount | NPCount | RECount | FECount | HIGH | LOW |
AMPLitude | MEAN | RMS | RTIME | FTIME | SRRise | SRFall |
PDCYcle | NDCYcle | PPWidth | NPWidth | CYCMean |
CYCRms | STDDev | CYCStddev | DELay | PHASE | BWIDth |
POVershoot | NOVershoot

See also: [Chapter 7.2.2, "Measurement Types"](#), on page 141.

FREQuency

Frequency of the signal. The result is based on the length of the left-most signal period within the displayed section of the waveform of the selected channel.

PERiod

Length of the left-most signal period within the displayed section of the waveform of the selected channel.

PEAK

Peak-to-peak value within the displayed section of the waveform of the selected channel.

UPEakvalue

Maximum (upper) value within the displayed section of the waveform of the selected channel.

LPEakvalue

Minimum (lower) value within the displayed section of the waveform of the selected channel.

PPCount | NPCount

Counts positive or negative pulses.

RECount | FECount

Counts the number of rising or falling edges.

HIGH | LOW

Mean value of the high or low level of a square wave.

AMPLitude

Amplitude of a square wave.

MEAN

Mean voltage value of the complete displayed waveform of the selected channel.

RMS

RMS (root mean square) voltage value of the complete displayed waveform of the selected channel.

RTIME | FTIME

Rise or falling time of the left-most rising or falling edge within the displayed section of the waveform of the selected channel.

The reference level for this measurement is set with [REFLevel:RELative:MODE](#).

SRRise | SRFall

Slew rate of the left-most rising or falling edge within the displayed section of the waveform of the selected channel. The reference level for this measurement is set with [REFLevel:RELative:MODE](#)

PDCycle | NDCycle

Positive or negative duty cycle.

PPWidth | NPWidth

Width of positive or negative pulses.

CYCMean

Mean voltage value of the left-most signal period of the waveform of the selected channel.

CYCRms

RMS (root mean square) voltage value of the left-most signal period of the waveform of the selected channel.

STDDev

Standard deviation of the waveform.

CYCStddev

Standard deviation of one cycle, usually of the first, left-most signal period.

DELay

Time difference between two edges of the same or different waveforms. The waveforms are selected with `MEASurement<m>:SOURce`, and the edges with `MEASurement<m>:DELay:SLOPe`.

PHASe

Phase difference between two waveforms (time difference/period * 360). The waveforms are selected with `MEASurement<m>:SOURce`.

BWIDth

Burst width, the duration of one burst, measured from the first edge to the last edge that crosses the middle reference level.

POVershoot | NOVershoot

Positive and negative overshoot of a square wave.

*RST: PEAK

MEASurement<m>:SOURce <SignalSource>[,<SignalSource2>]

Selects one of the active signal, reference or math channels as the source(s) of the selected measurement. Available sources depend on the selected measurement type.

Suffix:

<m> 1..8
Selects the measurement place.

Parameters:

<SignalSource> CH1..4 | MA1 | RE1..4 | D0..15
Waveform to be measured, required for all measurement types. For delay and phase measurements, it is the "Measure Source".

CH1 | CH2 | CH3 | CH4

Active signal channels 1 to 4

MA1

Active math channel

RE1 | RE2 | RE3 | RE4

Active reference channels 1 to 4

D0..D15

Active digital channels D0...D15. Only available, if MSO option R&S RTM-B1 is installed.

<SignalSource2> None | CH1..4 | MA1 | RE1..4 | D0..15
Second waveform, reference source that is required for delay and phase measurements ("Measure Source 2").

MEASurement<m>:DELay:SLOPe <SignalSlope>,<ReferenceSlope>

Sets the edges to be used for delay measurement. The associated waveforms are defined with `MEASurement<m>:SOURce`.

Parameters:

<SignalSlope>	POSitive NEGative Slope of first waveform ("Measure Source"). *RST: POS
<ReferenceSlope>	POSitive NEGative Slope of the reference waveform ("Measure Source 2"). *RST: POS

MEASurement<m>:STATistics[:ENABLE] <StatisticEnable>

Activates or deactivates the statistical evaluation for all active measurements.

Suffix:

<m>	1..8 The suffix is irrelevant.
-----	-----------------------------------

Parameters:

<StatisticEnable>	ON OFF *RST: OFF
-------------------	-----------------------

MEASurement<m>:STATistics:RESet

Deletes the statistical results for all measurements, and starts a new statistical evaluation if the acquisition is running. The waveform count is set to 0 and all measurement values are set to NAN.

Suffix:

<m>	1..8 The suffix is irrelevant.
-----	-----------------------------------

Usage: Event

16.7.2.2 Measurements Results

You can query the statistical results using the `MEAS:STAT` commands.

To export statistical results to a csv file, use the `EXP:MEAS:STAT` commands. Note that export of statistics is possible only remotely, but not in manual operation.

<code>MEASurement<m>:RESult[:ACTual]?</code>	493
<code>MEASurement<m>:RESult:AVG?</code>	493
<code>MEASurement<m>:RESult:STDDev?</code>	493
<code>MEASurement<m>:RESult:NPEak?</code>	494
<code>MEASurement<m>:RESult:PPEak?</code>	494
<code>MEASurement<m>:RESult:WFMCCount?</code>	494

MEASurement<m>:STATistics:WEIGHT?	494
MEASurement<m>:STATistics:VALue:ALL?	495
MEASurement<m>:STATistics:VALue<n>?	495
EXPort:MEASurement<m>:STATistics:NAME	495
EXPort:MEASurement<m>:STATistics:SAVE	496
EXPort:MEASurement:STATistics:ALL:NAME	496
EXPort:MEASurement:STATistics:ALL:SAVE	496

MEASurement<m>:RESult[:ACTual]? [<MeasType>]

Returns the result of the specified measurement type.

Suffix:

<m> 1..8
Selects the measurement place.

Query parameters:

<MeasType> FREQUency | PERiod | PEAK | UPEakvalue | LPEakvalue |
PPCount | NPCount | RECount | FECount | HIGH | LOW |
AMPLitude | MEAN | RMS | RTIME | FTIME | PDCYcle |
NDCYcle | PPWidth | NPWidth | CYCMean | CYCRms |
STDDev | CYCStddev | DELay | PHASe | BWIDth |
POVershoot | NOVershoot

Specifies the measurement type, see [MEASurement<m>:MAIN](#) on page 489. If you omit the parameter, the result of the last measurement setup is returned.

Return values:

<Value> Measurement result. If no measurement was executed, no value (NAN) is returned.

Usage: Query only

MEASurement<m>:RESult:AVG? <AverageValue>

Returns the average value of the current measurement series.

Suffix:

<m> 1..8
Selects the measurement place.

Query parameters:

<AverageValue> Statistic value

Usage: Query only

MEASurement<m>:RESult:STDDev? <StandardDeviation>

Returns the statistical standard deviation of the current measurement series.

Suffix:

<m> 1..8
Selects the measurement place.

Query parameters:

<StandardDeviation> Statistic value

Usage: Query only

MEASurement<m>:RESult:NPEak? <NegativePeak>

Returns the minimum measurement result of the current measurement series.

Suffix:

<m> 1..8
Selects the measurement place.

Query parameters:

<NegativePeak> Minimum measurement result

Usage: Query only

MEASurement<m>:RESult:PPEak? <PositivePeak>

Returns the maximum measurement result of the current measurement series.

Suffix:

<m> 1..8
Selects the measurement place.

Query parameters:

<PositivePeak> Maximum measurement result

Usage: Query only

MEASurement<m>:RESult:WFMCount? <WaveformCount>

Returns the current number of measured waveforms.

The query for MIN and MAX values is not possible.

Suffix:

<m> 1..8
Selects the measurement place.

Query parameters:

<WaveformCount> Number of measured waveforms

Usage: Query only

MEASurement<m>:STATistics:WEIGHT? <BufferSize>

Returns the size of the statistics buffer.

Suffix:

<m> 1..8
Selects the measurement place.

Return values:

<BufferSize> The buffer size is always 1000 result values.

Usage: Query only

MEASurement<m>:STATistics:VALue:ALL?

Returns all values from the statistics buffer.

Note: Valid buffered values can only be read if the acquisition is stopped. As long as the acquisition is running, the buffer contents is changing and the buffered values are not valid for reading.

Suffix:

<m> 1..8
Selects the measurement place.

Return values:

<ValueList> Comma separated List of Values
Comma-separated list of statistical values

Usage: Query only

MEASurement<m>:STATistics:VALue<n>?

Returns the n^{th} statistical value from the indicated buffer place.

Note: Valid buffered values can only be read if the acquisition is stopped. As long as the acquisition is running, the buffer contents is changing and the buffered values are not valid for reading.

Suffix:

<m> 1..8
Selects the measurement place.

<n> *
Buffer place. The buffer size is 1000 results.

Return values:

<StatisticValue> Statistical value

Usage: Query only

EXPort:MEASurement<m>:STATistics:NAME

Defines the path and filename of the statistics file. The file format is CSV. If the file already exists, it will be overwritten without notice.

Suffix:

<m> 1..4
Selects the measurement place.

Parameters:

<FileName> String parameter

EXPort:MEASurement<m>:STATistics:SAVE

Saves statistical results of the indicated measurement place to the file that is defined by the [EXPort:MEASurement<m>:STATistics:NAME](#) command.

Suffix:

<m> 1..4
 Selects the measurement place.

Usage: Event

See also: [EXPort:MEASurement:STATistics:ALL:SAVE](#) on page 496.

EXPort:MEASurement:STATistics:ALL:NAME

Defines the path and filename of the statistics file. The file format is CSV. If the file already exists, it will be overwritten.

Parameters:

<FileName> String parameter

EXPort:MEASurement:STATistics:ALL:SAVE

Saves statistical results of all measurement places to the file that is defined by the [EXPort:MEASurement:STATistics:ALL:NAME](#) command.

Example:

The file contains general information, statistical results, long term statistics, and the individual values that are used to calculate the statistics. The number of values is "Average No."

```
"Vendor", "Rohde&Schwarz",
"Device/Mat.-No.", "RTM3004 / 1335.8794K04",
"Serial No.", "2000001",
"Firmware Version", "01.101",
>Date", "2017-11-18 / 16:40:27",

"Meas. Place", "1", "2", "3",
"Type", "Frequency", "Mean Value", "Frequency",
"Source 1", "CH1", "CH1", "CH2",
"Source 2",
"Wave count", 42, 39, 37,
"Current", 4.998250e+05, 5.648727e-01, 4.998250e+05,
"Average No.", 1.000000e+03, 1.000000e+03, 1.000000e+03,
"Minimum", 4.997501e+05, 5.633875e-01, 4.997501e+05,
"Maximum", 4.998250e+05, 5.650349e-01, 4.998250e+05,
"Mean", 4.998179e+05, 5.642045e-01, 4.998169e+05,
"σ-Deviation", 2.199706e+01, 3.677224e-04, 2.326898e+01,
"Time of first value",
"Time of last value",
"Long term Minimum", 4.997501e+05, 5.633875e-01, 4.997501e+05,
"Long term Maximum", 4.998250e+05, 5.650349e-01, 4.998250e+05,
"Long term Mittelwert", 4.998179e+05, 5.642045e-01, 4.998169e+05,
"Long term σ-Deviation", 2.226370e+01, 3.725295e-04, 2.358995e+01,
"Long term start time",
"Long term end Time",

"Index", "Time Offset", "Value", "Time Offset", "Value",
"Time Offset", "Value",
1, 4.998250e+05, 5.649274e-01, 4.997501e+05,
2, 4.998250e+05, 5.649072e-01, 4.998250e+05,
3, 4.998250e+05, 5.650349e-01, 4.998250e+05,
4, 4.998250e+05, 5.641094e-01, 4.998250e+05,
5, 4.998250e+05, 5.640586e-01, 4.998250e+05,
6, 4.997501e+05, 5.642784e-01, 4.998250e+05,
7, 4.998250e+05, 5.637245e-01, 4.998250e+05, ...
```

Usage:

Event

16.7.2.3 Measurement Gate

MEASurement<m>:GATE.....	498
MEASurement<m>:GATE:MODE.....	498
MEASurement<m>:GATE:ABSolute:START.....	498
MEASurement<m>:GATE:ABSolute:STOP.....	498
MEASurement<m>:GATE:RELative:START.....	499
MEASurement<m>:GATE:RELative:STOP.....	499

MEASurement<m>:GATE <State>

Activates or deactivates the measurement gate.

To set the gate, use:

- `MEASurement<m>:GATE:MODE` and
- `MEASurement<m>:GATE:ABSolute:START` and `MEASurement<m>:GATE:ABSolute:STOP`
- or `MEASurement<m>:GATE:RELative:START` and `MEASurement<m>:GATE:RELative:STOP`

Suffix:

<m> 1..8
Selects the measurement place.

Parameters:

<State> ON | OFF
*RST: OFF

MEASurement<m>:GATE:MODE <GateMode>

Defines whether the gate is defined in absolute or relative values.

Suffix:

<m> 1..4
The suffix is irrelevant. One gate is used for all measurement places.

Parameters:

<GateMode> RELative | ABSolute
*RST: REL

MEASurement<m>:GATE:ABSolute:START <StartTime>

Defines the absolute start time for the measurement gate.

Suffix:

<m> 1..4
The suffix is irrelevant. One gate is used for all measurements.

Parameters:

<StartTime> *RST: -300e-6
Default unit: s

MEASurement<m>:GATE:ABSolute:STOP <StopTime>

Defines the absolute end time for the measurement gate.

Suffix:

<m> 1..4
The suffix is irrelevant. One gate is used for all measurements.

Parameters:

<StopTime> *RST: 300e-6
 Default unit: s

MEASurement<m>:GATE:RELative:START <StartPosition>

Defines the relative start value for the measurement gate.

Suffix:

<m> 1..4
 The suffix is irrelevant. One gate is used for all measurements.

Parameters:

<StartPosition> *RST: 25
 Default unit: %

MEASurement<m>:GATE:RELative:STOP <StopPosition>

Defines the relative end value for the measurement gate.

Suffix:

<m> 1..4
 The suffix is irrelevant. One gate is used for all measurements.

Parameters:

<StopPosition> *RST: 75
 Default unit: %

16.7.2.4 Reference Levels

REFLevel:RELative:MODE.....	499
REFLevel:RELative:LOWer.....	500
REFLevel:RELative:UPPer.....	500
REFLevel:RELative:MIDDle.....	500

REFLevel:RELative:MODE <RelativeMode>

Sets the lower and upper reference levels for rise and fall time measurements (cursor and automatic measurements) as well as the middle reference level for phase and delay measurements. The levels are defined as percentages of the high signal level. The setting is valid for all measurement places.

Parameters:

<RelativeMode> TEN | TWENTy | FIVE | USER
 TEN: 10, 50 and 90%
 TWENTy: 20, 50 and 80%
 FIVE: 5, 50 and 95 %
 USER: levels are defined with [REFLevel:RELative:LOWer](#),
 [REFLevel:RELative:MIDDle](#) and [REFLevel:RELative:UPPer](#).

*RST: TEN

Example:

```
REFL:REL:MODE TWENTy
MEAS2:MAIN RTIM
```

Sets the reference levels for all measurements and measures the rise time between these levels for measurement place 2:
 lower reference level = 20% of high signal level
 upper reference level = 80% of high signal level

REFLevel:RELative:LOWer <LowerLevel>

REFLevel:RELative:UPPer <UpperLevel>

Set the lower and upper reference levels for rise and fall time measurements (cursor and automatic measurements) if **REFLevel:RELative:MODE** is set to **USER**. The levels are defined as percentages of the high signal level. They are valid for all measurements.

Parameters:

<LowerLevel> *RST: 10
 Default unit: %

<UpperLevel> *RST: 90
 Default unit: %

REFLevel:RELative:MIDDLE <MiddleLevel>

Set the middle reference level that is used for phase and delay measurements, if **REFLevel:RELative:MODE** is set to **USER**. The level is defined as percentages of the high signal level. The setting is valid for all measurements.

Parameters:

<MiddleLevel> *RST: 50
 Default unit: %

16.7.3 Cursor Measurements

16.7.3.1 Cursor Settings

CURSor<m>:AOff.....	501
CURSor<m>:STATe.....	501
CURSor<m>:FUNcTion.....	501
CURSor<m>:SOURce.....	502
CURSor<m>:USSOURce.....	503
CURSor<m>:SSOURce.....	503
CURSor<m>:TRACking[:STATe].....	503
CURSor<m>:X1Position.....	503
CURSor<m>:X2Position.....	503
CURSor<m>:Y1Position.....	504
CURSor<m>:Y2Position.....	504

CURSor<m>:YCOupling.....	504
CURSor<m>:XCOupling.....	504
CURSor<m>:SWAVe.....	504
CURSor<m>:TRACking:SCALe[:STATe].....	504
CURSor<m>:SPPeak<n>.....	505
CURSor<m>:SNPeak<n>.....	505

CURSor<m>:AOFF

Switches the cursor off.

Suffix:

<m> 1, the suffix is irrelevant.

Usage: Event

CURSor<m>:STATe <State>

Activates or deactivates the cursor measurement.

Suffix:

<m> 1, the suffix is irrelevant.

Parameters:

<State> ON | OFF
*RST: OFF

CURSor<m>:FUNCTioN <Type>

Defines the cursor measurement type.

Suffix:

<m> 1, the suffix is irrelevant.

Parameters:

<Type> HORizontal | VERTical | HVERTical
To set the V-marker measurement, use CURSor<m>:
TRACking[:STATe].
*RST: VERTICAL

Value	Description	Queries for results
HORizontal	Sets two horizontal cursor lines and measures the voltages at the two cursor positions and the delta of the two values.	CURSor<m>:Y1Position CURSor<m>:Y2Position CURSor<m>:YDELta[:VALue]? CURSor<m>:YDELta:SLOPe?
VERTical	Sets two vertical cursor lines and measures the time from the trigger point to each cursor, the time between the two cursors and the frequency calculated from that time.	CURSor<m>:X1Position CURSor<m>:X2Position CURSor<m>:XDELta[:VALue]? CURSor<m>:XDELta:INVerse?
HVERTical	Combines the HORizontal cursor and VERTical cursor measurements. Two horizontal and two vertical cursor lines are set and the voltages and time from the trigger point are measured at the cursor positions, as well as the delta of the voltage and time values.	CURSor<m>:Y1Position CURSor<m>:Y2Position CURSor<m>:YDELta[:VALue]? CURSor<m>:X1Position CURSor<m>:X2Position CURSor<m>:XDELta[:VALue]?

CURSor<m>:SOURce <Source>

Defines the source of the cursor measurement.

Suffix:

<m> 1, the suffix is irrelevant.

Parameters:

<Source> CH1 | CH2 | CH3 | CH4 | MA1 | MA2 | MA3 | MA4 | MA5 | RE1 | RE2 | RE3 | RE4 | XY1 | XY2 | D70 | D158 | D0..15 | SPECtrum | MINHold | MAXHold | AVERage

CH1 | CH2 | CH3 | CH4

Active analog channel waveforms 1 to 4

MA1 | MA2 | MA3 | MA4 | MA5

Active math waveforms 1 to 5

RE1 | RE2 | RE3 | RE4

Active reference waveform 1 to 4

XY1 | XY2

Active XY-waveforms

D0..15

Active digital channels D0 to D15, available if MSO option R&S RTM-B1 is installed.

On individual digital channels, only vertical (time) cursor measurements are possible.

D70 | D158

Active digital channels D0...D7 (pod 1) and D8...D15 (pod 2). Only available, if MSO option R&S RTM-B1 is installed. On pods, only V-marker measurement is possible.

SPECTrum | MINHold | MAXHold | AVERage FFT waveforms

CURSor<m>:USSOURce <UseSecondSource>

Enables the second cursor source. To select the second source, use [CURSor<m>:SSOURce](#).

If enabled, the second cursor measures on the second source. Using a second source, you can measure differences between two waveforms with cursors. Both sources must be in the same domain (time domain or frequency domain).

Suffix:

<m> 1, the suffix is irrelevant.

Parameters:

<UseSecondSource> ON | OFF
*RST: OFF

CURSor<m>:SSOURce <SecondSource>

Selects the second cursor source.

Suffix:

<m> 1, the suffix is irrelevant.

Parameters:

<SecondSource> CH1 | CH2 | CH3 | CH4 | MA1 | MA2 | MA3 | MA4 | MA5 | RE1 | RE2 | RE3 | RE4 | XY1 | XY2 | D70 | D158 | D0..15 | SPECTrum | MINHold | MAXHold | AVERage
See [CURSor<m>:SOURce](#) on page 502.

CURSor<m>:TRACking[:STATe] <State>

If set to ON, the V-Marker cursor measurement is enabled.

Suffix:

<m> 1, the suffix is irrelevant.

Parameters:

<State> ON | OFF
*RST: OFF

CURSor<m>:X1Position <Xposition1>

CURSor<m>:X2Position <Xposition2>

The commands specify or return the positions of vertical cursor lines on the x-axis (time, frequency for FFT).

Suffix:

<m> 1, the suffix is irrelevant.

Suffix:

<m> 1, the suffix is irrelevant.

Parameters:

<State> ON | OFF

ON

Cursor lines keep their relative position to the waveform.

OFF

Cursor lines remain on their position on the display if the scaling is changed.

*RST: OFF

CURSor<m>:SPPeak<n>**CURSor<m>:SNPeak<n>**

Set the cursor line to the previous / next peak, respectively. The command is only available for FFT waveforms.

Suffix:

<m> 1, the suffix is irrelevant.

<n> 1..2
Selects the cursor line.

Usage: Event

16.7.3.2 Cursor Measurement Results

To get the measurement values of vertical cursor lines (time, frequency for FFT), use:

- CURSor<m>:X1Position on page 503
- CURSor<m>:X2Position on page 503

To get the measurement values of horizontal cursor lines (voltage, current, level for FFT), use:

- CURSor<m>:Y1Position on page 504
- CURSor<m>:Y2Position on page 504

CURSor<m>:XDELta[:VALue]?	505
CURSor<m>:XDELta:INVerse?	506
CURSor<m>:YDELta[:VALue]?	506
CURSor<m>:YDELta:SLOPe?	506

CURSor<m>:XDELta[:VALue]?

Returns the time difference between two vertical cursor lines (Δt).

Suffix:

<m> 1, the suffix is irrelevant.

Return values:

<Delta> Range: -100E24 to 100E24
 Increment: 0.1
 Default unit: s

Usage: Query only

CURSor<m>:XDELta:INVerse?

Returns the inverse time difference between the two cursors ($1/\Delta t$, frequency).

Suffix:

<m> 1, the suffix is irrelevant.

Return values:

<DeltaInverse> Range: -100E24 to 100E24
 Increment: 0.1
 Default unit: 1/s

Usage: Query only

CURSor<m>:YDELta[:VALue]?

Queries the delta of the values in y-direction at the two cursor lines.

Suffix:

<m> 1, the suffix is irrelevant.

Return values:

<YDelta> Delta value

Usage: Query only

CURSor<m>:YDELta:SLOPe?

Returns the inverse value of the vertical difference (e.g. voltage difference) - the reciprocal of the vertical distance of two horizontal cursor lines: $1/\Delta V$.

Suffix:

<m> 1, the suffix is irrelevant.

Return values:

<Slope> Inverse value

Usage: Query only

16.8 Applications

16.8.1 General

DEVIce:MODE

Sets the operation mode or application.

Parameters:

<OperationalMode> YT | ZOOM | XY | QMEas | UPDate | AUToset | MASKtest | FFT

16.8.2 Mask Testing

16.8.2.1 Mask Setup

MASK:STATe.....	507
MASK:SOURce.....	507
MASK:CHCopy.....	508
MASK:YPOsition.....	508
MASK:YSCale.....	508
MASK:XWIDth.....	508
MASK:YWIDth.....	508
MASK:SAVE.....	508
MASK:LOAD.....	509

MASK:STATe <State>

Turns the mask test application on or off. When turning off, any temporarily stored masks are deleted.

Parameters:

<State> ON | OFF
*RST: OFF

MASK:SOURce <Source>

Defines the channel to be compared with the mask, and also the channel from which the mask is created.

Parameters:

<Source> CH1 | CH2 | CH3 | CH4
CH3 and CH4 are only available on 4-channel models.
*RST: CH1

MASK:CHCopy

Creates a mask from the envelope waveform of the source set with **MASK:SOURce**.

Usage: Event

MASK:YPOStion <Yposition>

Moves the mask vertically within the display.

Parameters:

<Yposition> Mask offset from the vertical center
Default unit: div

MASK:YSCale <Yscale>

Changes the vertical scaling to stretch or compress the mask in y-direction.

Parameters:

<Yscale> A value over 100% stretches the amplitudes; a value less than 100% compresses the amplitudes.
Default unit: %

MASK:XWIDth <Xaddition>

Changes the width of the mask in horizontal direction.

Parameters:

<Xaddition> The value is added to the positive x-values and subtracted from the negative x-values of the mask limits in relation to the mask center.
Default unit: div

MASK:YWIDth <Yaddition>

Changes the width of the mask in vertical direction.

Parameters:

<Yaddition> The value is added to the y-values of the upper mask limit and subtracted from the y-values of the lower mask limit.
Default unit: div

MASK:SAVE <Filename>

Saves the current mask in the specified file.

Setting parameters:

<Filename> String parameter
Path and file name

Usage: Setting only

MASK:LOAD <Filename>

Loads a stored mask from the specified file.

Setting parameters:

<Filename> String parameter
Path and file name

Usage: Setting only

16.8.2.2 Actions on Violation

MASK:ACTion:SOUNd:EVENT:MODE	509
MASK:ACTion:STOP:EVENT:MODE	509
MASK:ACTion:SCRSave:EVENT:MODE	509
MASK:ACTion:WFMSave:EVENT:MODE	509
MASK:ACTion:PULSe:EVENT:MODE	509
MASK:ACTion:STOP:EVENT:COUNT	510
MASK:ACTion:SCRSave:DESTination	510
MASK:ACTion:WFMSave:DESTination	510
MASK:ACTion:YOUT:ENABLE	511

MASK:ACTion:SOUNd:EVENT:MODE <EventMode>

MASK:ACTion:STOP:EVENT:MODE <EventMode>

MASK:ACTion:SCRSave:EVENT:MODE <EventMode>

MASK:ACTion:WFMSave:EVENT:MODE <EventMode>

MASK:ACTion:PULSe:EVENT:MODE <EventMode>

Defines when and how often the action is executed.

- **SOUNd:** Generates a beep sound on mask violation.
- **STOP:** Stops the waveform acquisition, after mask is violated for a defined number of times. You can set how many times with the command [MASK:ACTion:STOP:EVENT:COUNT](#).
- **PULSe:** Creates a pulse on the [Aux Out] connector. This selection sets the configuration of the [Aux Out] connector to "Mask Violation".
- **SCRSave:** Saves a screenshot on mask violation. To set path and filename of the screenshot, use [MASK:ACTion:SCRSave:DESTination](#).
- **WFMSave:** Saves the waveform data on mask violation. To set path and filename of the data file, use [MASK:ACTion:WFMSave:DESTination](#).

Parameters:

<EventMode> OFF | EACH

OFF

No action is executed.

EACH

The selected action is executed on each violation of the mask.

*RST: OFF

MASK:ACTion:STOP:EVENT:COUNT <EventCount>

Sets the number of mask violations after which the action is executed.

Parameters:

<EventCount> Integer value, number of the violations that executes the action.

MASK:ACTion:SCRSave:DESTination <Path>

Defines the directory for a screenshot that is saved on mask violation. The file format is defined with `HCOP:LANG`. The filename is manually defined in the "File" > "Screenshots" dialog box and is incremented automatically, starting from 01.

Parameters:

<Path> String parameter

Example:

Prerequisite: a mask ist defined, and a waveform that hits the mask.

```
MASK:ACT:SCRS:DEST "/USB_FRONT/MASKS" //directory must exist
HCOP:LANG PNG
MASK:ACT:SCRS:EVEN:MODE EACH
MASK:TEST RUN
RUN
```

On first violation, the screenshot is saved to <name>01.PNG, on second violation to <name>02.PNG, the third to <name>03.PNG ...

MASK:ACTion:WFMSave:DESTination <Path>

Defines the directory for waveform data files that are saved on mask violation. The file format is defined with `FORMAT`. The filename is manually defined in the "File" > "Waveforms" dialog box and is incremented automatically, starting from 01.

Parameters:

<Path> String parameter

Example:

Prerequisite: a mask ist defined, and a waveform that hits the mask.

```
MASK:ACT:WFMS:DEST "/USB_FRONT/MASKS" //directory must exist
FORM CSV,0
MASK:ACT:WFMS:EVEN:MODE EACH
MASK:TEST RUN
RUN
```

On first violation, the waveform data is saved to <name>01.CSV, on second violation to <name>02.CSV, the third to <name>03.CSV ...

MASK:ACTion:YOUT:ENABle <Yout>

Same as [MASK:ACTion:PULSe:EVENT:MODE](#) on page 509.

Parameters:

<Yout> ON | OFF
 *RST: OFF

16.8.2.3 Mask Test

MASK:TEST	511
MASK:RESet:COUNter	511
MASK:COUNt?	511
MASK:VCOunt?	511
MASK:CAPTure[MODE]	512

MASK:TEST <Test>

Starts, finishes or interrupts a mask test.

Parameters:

<Test> RUN | STOP | PAUSE
 *RST: STOP

MASK:RESet:COUNter

Sets the counters of passed and failed acquisitions to Zero.

Usage: Event

MASK:COUNt?

Returns the number of tested acquisitions.

Return values:

<TotalCount> Total number of tested acquisitions

Usage: Query only

MASK:VCOunt?

Returns the number of acquisitions that hit the mask.

Return values:

<ViolationCount> Total number of violations

Usage: Query only

MASK:CAPTURE[:MODE] <CaptureMode>

Only available with history. The command selects whether all acquisitions are stored in segments, or only failed acquisition. You can use the history to analyze the segments.

Parameters:

<CaptureMode> ALL | FAILED
 *RST: ALL

16.8.2.4 Mask Data

Use the following commands that are described in [Chapter 16.9.1.5, "Masks"](#), on page 547:

- [MASK:DATA?](#) on page 547
- [MASK:DATA:HEADer?](#) on page 547
- [MASK:DATA:XINCrement?](#) on page 549
- [MASK:DATA:XORigin?](#) on page 548
- [MASK:DATA:YINCrement?](#) on page 550
- [MASK:DATA:YORigin?](#) on page 549
- [MASK:DATA:YRESolution?](#) on page 550

16.8.3 FFT Analysis

- [General Settings](#)..... 512
- [Frequency Settings](#)..... 514
- [Time Settings](#)..... 516
- [Waveform Settings](#)..... 516
- [Waveform Data](#)..... 517

16.8.3.1 General Settings

- [SPECTrum\[:STATe\]](#)..... 512
- [SPECTrum:SOURce](#)..... 513
- [SPECTrum:FREQuency:WINDow:TYPE](#)..... 513
- [SPECTrum:FREQuency:MAGNitude:SCALE](#)..... 513
- [SPECTrum:FREQuency:POSition](#)..... 514
- [SPECTrum:FREQuency:SCALE](#)..... 514
- [DISPlay:CBAR:FFT\[:POSition\]](#)..... 514

SPECTrum[:STATe]

Switches on the spectrum analysis.

Parameters:

<State> ON | OFF

SPECTrum:SOURce

Selects the source for the spectrum analysis diagrams.

Parameters:

<Source> CH1 | CH2 | CH3 | CH4

SPECTrum:FREQUency:WINDow:TYPE

Window functions are multiplied with the input values and thus can improve the spectrum analysis display.

Parameters:

<WindowFunction> RECTangular | HAMMING | HANNING | BLACKmanharris | FLATtop

RECTangular

The rectangular window has high frequency accuracy with thin spectral lines, but with increased noise. Use this function preferably with pulse response tests where start and end values are zero.

HAMMING

The Hamming window has higher noise level inside the spectrum than Hann or Blackman, but smaller than the rectangular window. The width of the spectral lines is thinner than the other bell-shaped functions. Use this window to measure amplitudes of a periodical signal precisely.

HANNING

The noise level within the spectrum is reduced and the width of the spectral lines enlarges. Use this window to measure amplitudes of a periodical signal precisely.

BLACKmanharris

In the Blackman window the amplitudes can be measured very precisely. However, determining the frequency is more difficult. Use this window to measure amplitudes of a periodical signal precisely.

FLATtop

The flat top window has low amplitude measurement errors but a poor frequency resolution. Use this window for accurate single-tone measurements and for measurement of amplitudes of sinusoidal frequency components.

SPECTrum:FREQUency:MAGNitude:SCALE <MagnitudeScale>

Defines the scaling unit of the y-axis.

Parameters:

<MagnitudeScale> LINear | DBM | DBV | DBUV

LINear

Linear scaling, displays the RMS value of the voltage.

DBM

Logarithmic scaling, related to 1 mW.

DBV

Logarithmic scaling, related to 1 V_{eff}.

DBUV

Logarithmic scaling; related to 1 μV_{eff}.

SPECTrum:FREQUENCY:POSITION

Defines the vertical position of the spectrum.

Parameters:

<Position> Default unit: div

SPECTrum:FREQUENCY:SCALE

Sets the vertical scale of the spectrum analysis waveform.

Parameters:

<Scale> Range values and unit depend on [SPECTrum:FREQUENCY:MAGNitude:SCALE](#).

DISPlay:CBAR:FFT[:POSITION] <DividerPosition>

Defines the position of the divide bar between normal waveform and FFT window.

Parameters:

<DividerPosition> Vertical position in pixel, measured from the top edge. The vertical display size is 800 px.
Default unit: px

16.8.3.2 Frequency Settings

SPECTrum:FREQUENCY:CENTer	514
SPECTrum:FREQUENCY:FULLspan	515
SPECTrum:FREQUENCY:SPAN	515
SPECTrum:FREQUENCY:START	515
SPECTrum:FREQUENCY:STOP	515
SPECTrum:FREQUENCY:BANDwidth[:RESolution][:VALue]	515
SPECTrum:FREQUENCY:BANDwidth[:RESolution]:RATio	515

SPECTrum:FREQUENCY:CENTer

Defines the position of the displayed frequency domain, which is (Center - Span/2) to (Center + Span/2). The width of the domain is defined using the command [SPECTrum:FREQUENCY:SPAN](#).

Parameters:

<CenterFrequency>

SPECTrum:FREQuency:FULLspan

Performs the spectrum analysis calculation for the full frequency span.

Usage: Event

SPECTrum:FREQuency:SPAN

The span is specified in Hertz and defines the width of the displayed frequency range, which is (Center - Span/2) to (Center + Span/2).

Parameters:

SPECTrum:FREQuency:START

Defines the start frequency of the displayed frequency domain at the left display edge: *Center - Span/2*

You can set start and stop frequency instead of defining a center frequency and span.

Parameters:

<StartFrequency> Range: Depends on various other settings, mainly on time base, span/RBW ratio, and center frequency.

SPECTrum:FREQuency:STOP

Defines the stop frequency of the displayed frequency domain at the right display edge: *Center + Span/2*

You can set start and stop frequency instead of defining a center frequency and span.

Parameters:

<StopFrequency> Range: Depends on various other settings, mainly on time base, span/RBW ratio, and center frequency.

SPECTrum:FREQuency:BANDwidth[:RESolution][:VALue] <ResolutionBandwidth>

Defines the resolution bandwidth - the minimum frequency step at which the individual components of a spectrum can be distinguished.

Parameters:

<ResolutionBandwidthRange> Range: Depends on various other settings.

SPECTrum:FREQuency:BANDwidth[:RESolution]:RATio <SpanRBWratio>

Defines the ratio of span (Hz) / resolution bandwidth (Hz). The span/RBW ratio is half the number of points used for FFT which is defined with manual operation in the menu.

Parameters:

<SpanRBWratio> Range: The value is changed in 2ⁿ steps from 2¹⁰ to 2¹⁵ (1024, 2048, 4096, 8192, 16384, 32768).

16.8.3.3 Time Settings

SPECTrum:TIME:POSition.....	516
SPECTrum:TIME:RANGe.....	516

SPECTrum:TIME:POSition <TimePosition>

Sets the time position of the analyzed time range.

Parameters:

<TimePosition>

SPECTrum:TIME:RANGe <TimeRange>

Sets the time range for the time domain diagram.

Parameters:

<TimeRange>

16.8.3.4 Waveform Settings

SPECTrum:WAVeform:AVERage[:ENABLE].....	516
SPECTrum:WAVeform:MAXimum[:ENABLE].....	516
SPECTrum:WAVeform:MINimum[:ENABLE].....	516
SPECTrum:WAVeform:SPECTrum[:ENABLE].....	516
SPECTrum:FREQuency:AVERage:COUNT.....	516
SPECTrum:FREQuency:AVERage:COMPLete?.....	516
SPECTrum:FREQuency:RESet.....	517

SPECTrum:WAVeform:AVERage[:ENABLE] <WaveformEnable>

SPECTrum:WAVeform:MAXimum[:ENABLE] <WaveformEnable>

SPECTrum:WAVeform:MINimum[:ENABLE] <WaveformEnable>

SPECTrum:WAVeform:SPECTrum[:ENABLE] <WaveformEnable>

Enables/disables the indicated waveform.

Parameters:

<WaveformEnable> ON | OFF

*RST: ON

SPECTrum:FREQuency:AVERage:COUNT <AverageCount>

Defines the number of spectrums used for averaging.

Parameters:

<AverageCount>

SPECTrum:FREQuency:AVERage:COMPLete?

Returns the state of spectrum averaging.

Parameters:

<AverageComplete>

Usage: Query only**SPECTrum:FREQuency:RESet**

Resets the Min Hold, Max Hold, Spectrum and Average waveforms to the current waveform.

Usage: Event**16.8.3.5 Waveform Data**

SPECTrum:WAVeform:AVERage:DATA?	517
SPECTrum:WAVeform:MAXimum:DATA?	517
SPECTrum:WAVeform:MINimum:DATA?	518
SPECTrum:WAVeform:SPECTrum:DATA?	518
SPECTrum:WAVeform:AVERage:DATA:HEADer?	518
SPECTrum:WAVeform:MAXimum:DATA:HEADer?	518
SPECTrum:WAVeform:MINimum:DATA:HEADer?	518
SPECTrum:WAVeform:SPECTrum:DATA:HEADer?	518
SPECTrum:WAVeform:AVERage:DATA:POINts?	518
SPECTrum:WAVeform:MAXimum:DATA:POINts?	518
SPECTrum:WAVeform:MINimum:DATA:POINts?	518
SPECTrum:WAVeform:SPECTrum:DATA:POINts?	518
SPECTrum:WAVeform:AVERage:DATA:XINCrement?	518
SPECTrum:WAVeform:MAXimum:DATA:XINCrement?	518
SPECTrum:WAVeform:MINimum:DATA:XINCrement?	518
SPECTrum:WAVeform:SPECTrum:DATA:XINCrement?	518
SPECTrum:WAVeform:AVERage:DATA:XORigin?	518
SPECTrum:WAVeform:MAXimum:DATA:XORigin?	518
SPECTrum:WAVeform:MINimum:DATA:XORigin?	519
SPECTrum:WAVeform:SPECTrum:DATA:XORigin?	519
SPECTrum:WAVeform:AVERage:DATA:YINCrement?	519
SPECTrum:WAVeform:MAXimum:DATA:YINCrement?	519
SPECTrum:WAVeform:MINimum:DATA:YINCrement?	519
SPECTrum:WAVeform:SPECTrum:DATA:YINCrement?	519
SPECTrum:WAVeform:AVERage:DATA:YORigin?	519
SPECTrum:WAVeform:MAXimum:DATA:YORigin?	519
SPECTrum:WAVeform:MINimum:DATA:YORigin?	519
SPECTrum:WAVeform:SPECTrum:DATA:YORigin?	519
SPECTrum:WAVeform:AVERage:DATA:YRESolution?	519
SPECTrum:WAVeform:MAXimum:DATA:YRESolution?	519
SPECTrum:WAVeform:MINimum:DATA:YRESolution?	519
SPECTrum:WAVeform:SPECTrum:DATA:YRESolution?	519

SPECTrum:WAVeform:AVERage:DATA?**SPECTrum:WAVeform:MAXimum:DATA?**

SPECTrum:WAVeform:MINimum:DATA?
SPECTrum:WAVeform:SPECTrum:DATA?

Returns the data of the indicated waveform points for transmission from the instrument to the controlling computer. The waveform data can be used in MATLAB, for example.

Return values:

<Data> List of values

Usage: Query only

SPECTrum:WAVeform:AVERage:DATA:HEADer?
SPECTrum:WAVeform:MAXimum:DATA:HEADer?
SPECTrum:WAVeform:MINimum:DATA:HEADer?
SPECTrum:WAVeform:SPECTrum:DATA:HEADer?

Returns information on the indicated waveform.

Return values:

<Header> StringData

Usage: Query only

SPECTrum:WAVeform:AVERage:DATA:POINts?
SPECTrum:WAVeform:MAXimum:DATA:POINts?
SPECTrum:WAVeform:MINimum:DATA:POINts?
SPECTrum:WAVeform:SPECTrum:DATA:POINts?

Returns the number of data samples that are returned with `SPECTrum:WAVeform:xxx:DATA` for the indicated waveform.

Return values:

<DataPoints>

Usage: Query only

SPECTrum:WAVeform:AVERage:DATA:XINCrement?
SPECTrum:WAVeform:MAXimum:DATA:XINCrement?
SPECTrum:WAVeform:MINimum:DATA:XINCrement?
SPECTrum:WAVeform:SPECTrum:DATA:XINCrement?

Return the level difference between two adjacent samples of the indicated waveform.

Return values:

<Xincrement>

Usage: Query only

SPECTrum:WAVeform:AVERage:DATA:XORigin?
SPECTrum:WAVeform:MAXimum:DATA:XORigin?

SPECTrum:WAVeform:MINimum:DATA:XORigin?

SPECTrum:WAVeform:SPECTrum:DATA:XORigin?

Returns the frequency of the first sample of the indicated waveform.

Return values:

<Xorigin>

Usage: Query only

SPECTrum:WAVeform:AVERage:DATA:YINCrement?

SPECTrum:WAVeform:MAXimum:DATA:YINCrement?

SPECTrum:WAVeform:MINimum:DATA:YINCrement?

SPECTrum:WAVeform:SPECTrum:DATA:YINCrement?

Returns the voltage value per bit of the indicated waveform.

Return values:

<Yincrement>

Usage: Query only

SPECTrum:WAVeform:AVERage:DATA:YORigin?

SPECTrum:WAVeform:MAXimum:DATA:YORigin?

SPECTrum:WAVeform:MINimum:DATA:YORigin?

SPECTrum:WAVeform:SPECTrum:DATA:YORigin?

Returns the vertical bit resolution of the indicated waveform.

Return values:

<Yorigin>

Usage: Query only

SPECTrum:WAVeform:AVERage:DATA:YRESolution?

SPECTrum:WAVeform:MAXimum:DATA:YRESolution?

SPECTrum:WAVeform:MINimum:DATA:YRESolution?

SPECTrum:WAVeform:SPECTrum:DATA:YRESolution?

Returns the vertical bit resolution of the indicated waveform.

Return values:

<Yresolution>

Usage: Query only

16.8.4 Spectrum Analysis (Option R&S RTM-K18)

- [Spectrogram](#).....520
- [Peak List Settings](#)..... 520
- [Reference Marker](#)..... 522
- [Peak List Results](#)..... 524
- [Display Settings for Spectrum and Spectrogram](#)..... 526

16.8.4.1 Spectrogram

SPECTrum:SPECTrogram:RESet

Resets the current spectrogram and starts a new recording of information.

Usage: Event

SPECTrum:SPECTrogram:SCALe <LinesPerAcquisition>

Defines a zoom factor for the spectrogram.

Parameters:

<LinesPerAcquisition>Range: 1 to 20
 Increment: 1
 *RST: 1

DISPlay:CBAR:SPECTrogram[:POSition] <DividerPosition>

Defines the position of the divide bar on top of the spectrogram.

Parameters:

<DividerPosition> Vertical position in pixel, measured from the top edge. The vertical display size is 800 px.
 Default unit: px

16.8.4.2 Peak List Settings

SPECTrum:MARKer:RTABLE:ENABLE.....	520
SPECTrum:MARKer[:ENABLE].....	520
SPECTrum:MARKer:SOURce.....	521
SPECTrum:MARKer:SETup:MMODE.....	521
SPECTrum:MARKer:SETup:MLEVel.....	521
SPECTrum:MARKer:SETup:DISTance.....	521
SPECTrum:MARKer:SETup:EXCURsion.....	521
SPECTrum:MARKer:SETup:MWIDth.....	522
SPECTrum:MARKer:REFerence:SETup:CMPeak.....	522
SPECTrum:MARKer:REFerence:SETup:CSCReen.....	522

SPECTrum:MARKer:RTABLE:ENABLE <ResultTable>

Shows the peak list.

Parameters:

<ResultTable> ON | OFF
 *RST: OFF

SPECTrum:MARKer[:ENABLE]

Enables the usage of markers.

Parameters:

<MarkerEnable> ON | OFF

SPECTrum:MARKer:SOURce

Defines the waveform type that is searched for peaks.

Parameters:

<Source> SPECTrum | MINHold | MAXHold | AVERage
*RST: SPEC

SPECTrum:MARKer:SETup:MMODE

Sets the mode for peak detection.

Parameters:

<MarkerMode> LONLY | ADVanced

LONLY

Level only: detects a peak when a certain minimum level is exceeded. You can define the minimum level with [SPECTrum:MARKer:SETup:MLEVel](#).

ADVanced

Enables a more precise advanced peak definition.

SPECTrum:MARKer:SETup:MLEVel

Sets the minimum level for marker peak detection.

Parameters:

<MinimumLevel>

SPECTrum:MARKer:SETup:DISTance

Sets a distance between two subsequent peaks that has to be kept, for the peak to be detected.

Parameters:

<Distance>

SPECTrum:MARKer:SETup:EXCursion

Sets a level difference between two subsequent peaks that has to be kept, for the peak to be detected.

Parameters:

<Excursion>

SPECTrum:MARKer:SETup:MWIDth

Sets the maximum width, that a peak can have for it to be detected.

Parameters:

<MaximumWidth>

SPECTrum:MARKer:REFerence:SETup:CMPeak

Centers the display to the highest detected peak.

Usage: Event

SPECTrum:MARKer:REFerence:SETup:CSCReen

Centers the display to the center frequency.

Usage: Event

16.8.4.3 Reference Marker

SPECTrum:MARKer:REFerence:SETup:MODE.....	522
SPECTrum:MARKer:REFerence:SETup:INDex.....	522
SPECTrum:MARKer:REFerence:SETup:FREQuency.....	523
SPECTrum:MARKer:REFerence:SETup:SPAN.....	523
SPECTrum:MARKer:RMARker?.....	523
SPECTrum:MARKer:RMARker:FREQuency?.....	523
SPECTrum:MARKer:RMARker:LEVel?.....	523
SPECTrum:MARKer:RMODE.....	523

SPECTrum:MARKer:REFerence:SETup:MODE

Sets the mode for the selection of the reference peak.

Parameters:

<ReferenceMode> OFF | INDicated | RANGe

The reference marker is set to the peak with a specified index number.

RANGe

The peak with the highest level within the selected range is set as the reference marker.

SPECTrum:MARKer:REFerence:SETup:INDex

Sets the reference marker to the peak with the specified index, if `SPECTrum:MARKer:REFerence:SETup:MODE` is set to `INDicated`.

Parameters:

<ReferenceIndex>

SPECTrum:MARKer:REFerence:SETup:FREQuency

Sets the center frequency for the capture range, if `SPECTrum:MARKer:REFerence:SETup:MODE` is set to `RANGe`.

Parameters:

<ReferenceFrequency>

SPECTrum:MARKer:REFerence:SETup:SPAN

Sets the span range, the ratio of the capture range and the width of the specified reference mode, if `SPECTrum:MARKer:REFerence:SETup:MODE` is set to `RANGe`.

Parameters:

<ReferenceSpan>

SPECTrum:MARKer:RMARker?

Returns the frequency and the level values of the present reference marker.

Return values:

<ReferenceFrequency>

<ReferenceLevel>

Usage: Query only

SPECTrum:MARKer:RMARker:FREQuency?

Returns the frequency of the reference marker.

Return values:

<ReferenceFrequency>

Usage: Query only

SPECTrum:MARKer:RMARker:LEVel?

Returns the level of the reference marker.

Return values:

<ReferenceLevel>

Usage: Query only

SPECTrum:MARKer:RMODe <ResultMode>

Defines the values that are shown in the peak list. You can use absolute values, or delta values in comparison to the reference marker.

Parameters:

<ResultMode> ABSolute | FREQuency | LEVel | FLEVel

ABSolute

Frequency and magnitude in absolute values.

FREquency

Frequency relative to the reference marker frequency, magnitude in absolute values.

LEVel

Frequency in absolute values, magnitude relative to the level of the reference marker.

FLEVel

Frequency and magnitude relative to the reference marker values.

16.8.4.4 Peak List Results

SPECTrum:MARKer:RCOunt?.....	524
SPECTrum:MARKer:RESult<n>?.....	524
SPECTrum:MARKer:RESult<n>:ALL?.....	524
SPECTrum:MARKer:RESult<n>:ALL:DELTA?.....	525
SPECTrum:MARKer:RESult<n>:DELTA?.....	525
SPECTrum:MARKer:RESult<n>:FREquency?.....	525
SPECTrum:MARKer:RESult<n>:FREquency:DELTA?.....	525
SPECTrum:MARKer:RESult<n>:LEVel?.....	526
SPECTrum:MARKer:RESult<n>:LEVel:DELTA?.....	526

SPECTrum:MARKer:RCOunt?

Returns the number of detected peaks.

Parameters:

<ResultCount>

Usage: Query only

SPECTrum:MARKer:RESult<n>?

Returns the frequency and level values of the n-th marker.

Suffix:

<n> *

Return values:

<ResultFrequency>

<ResultLevel>

Usage: Query only

SPECTrum:MARKer:RESult<n>:ALL?

Returns a list of all marker with the corresponding frequency and level values.

Suffix:

<n> *

Return values:

<ResultValues> List of numeric values with shape <freq>,<level>,....

Usage:

Query only

SPECTrum:MARKer:RESult<n>:ALL:DELTA?

Returns the delta frequency and delta level, the difference between the frequency/level of the specified marker and the frequency/level of the reference marker.

Suffix:

<n> *

Return values:

<ResultValues> List of numeric values with shape <freq>,<level>,....

Usage:

Query only

SPECTrum:MARKer:RESult<n>:DELTA?

Returns the difference in the values between the n-th marker and the reference marker.

Suffix:

<n> *

Usage:

Query only

SPECTrum:MARKer:RESult<n>:FREQUENCY?

Returns the frequency of the n-th marker.

Suffix:

<n> *

Return values:

<ResultFrequency>

Usage:

Query only

SPECTrum:MARKer:RESult<n>:FREQUENCY:DELTA?

Returns the delta frequency, the difference between the frequency of the specified marker and the level of the reference marker.

Suffix:

<n> *

Return values:

<ResultFrequencyDifference>

Usage: Query only

SPECTrum:MARKer:RESult<n>:LEVel?

Returns the level of the n-th marker.

Suffix:
<n> *

Return values:
<ResultLevel>

Usage: Query only

SPECTrum:MARKer:RESult<n>:LEVel:DELTA?

Returns the delta level, the difference between the level of the specified marker and the level of the reference marker.

Suffix:
<n> *

Return values:
<ResultLevelDifference>

Usage: Query only

16.8.4.5 Display Settings for Spectrum and Spectrogram

SPECTrum:FREQuency:BANDwidth[:RESolution]:AUTO.....	526
SPECTrum:DIAGram:COLor:MAGNitude:MODE.....	526
SPECTrum:DIAGram:COLor:MAXimum[:LEVel].....	527
SPECTrum:DIAGram:COLor:MINimum[:LEVel].....	527
SPECTrum:DIAGram:COLor:SCHeme:FDOMain.....	527
SPECTrum:DIAGram:COLor:SCHeme:SPECTrogram.....	527
SPECTrum:DIAGram:SPECTrogram[:ENABle].....	527

SPECTrum:FREQuency:BANDwidth[:RESolution]:AUTO <AutoSpanRBWratio>

Enables the auto resolution bandwidth mode. In the auto mode "Span": "RBW" ratio of ~1:100 is set.

Parameters:
<AutoSpanRBWratio> ON | OFF
*RST: ON

SPECTrum:DIAGram:COLor:MAGNitude:MODE <MagnitudeMode>

Enables the magnitude coloring of the waveform.

Parameters:
<MagnitudeMode> ON | OFF

SPECTrum:DIAGram:COLor:MAXimum[:LEVel] <MaximumLevel>

Sets the level used as a maximum of the color scale selected with `SPECTrum:DIAGram:COLor:SCHEME:SPECTrogram/SPECTrum:DIAGram:COLor:SCHEME:FDOMain`.

All level values lower than the minimum are displayed with the minimum color.

Parameters:

<MaximumLevel>

SPECTrum:DIAGram:COLor:MINimum[:LEVel] <MinimumLevel>

Sets the level used as a minimum of the color scale selected with `SPECTrum:DIAGram:COLor:SCHEME:SPECTrogram/SPECTrum:DIAGram:COLor:SCHEME:FDOMain`.

All level values lower than the minimum are displayed with the minimum color.

Parameters:

<MinimumLevel>

SPECTrum:DIAGram:COLor:SCHEME:FDOMain <ColorScheme>

Sets the color scale for the display of the waveform in the frequency domain diagram.

Parameters:

<ColorScheme> MONochrome | TEMPerature | RAINbow

SPECTrum:DIAGram:COLor:SCHEME:SPECTrogram <ColorScheme>

Sets the color scale for the display of the spectrogram.

Parameters:

<ColorScheme> MONochrome | TEMPerature | RAINbow

SPECTrum:DIAGram:SPECTrogram[:ENABLE] <Enable>

Enables the display of the spectrum diagram.

Parameters:

<Enable> ON | OFF

16.8.5 XY-Waveforms

<code>DISPlay:MODE</code>	528
<code>DISPlay:XY:XSource</code>	528
<code>DISPlay:XY:Y1Source</code>	528
<code>DISPlay:XY:Y2Source</code>	528

DISPlay:MODE <Mode>

Sets the diagram mode.

Parameters:

<Mode> YT | XY

YT

Default time diagram with a time axis in x-direction and the signal amplitudes displayed in y-direction.

XY

XY-diagram, combines the voltage levels of two waveforms in one diagram.

*RST: YT

DISPlay:XY:XSource <Source>

Defines the source to be displayed in x-direction in an XY-diagram, replacing the usual time base.

Parameters:

<Source> CH1 | CH2 | CH3 | CH4

CH3 and CH4 are only available with 4-channel R&S RTM3000 oscilloscopes.

*RST: CH1

DISPlay:XY:Y1Source <Source>

Defines the first source to be displayed in y-direction in an XY-diagram.

Parameters:

<Source> CH1 | CH2 | CH3 | CH4

CH3 and CH4 are only available with 4-channel R&S RTM3000 oscilloscopes.

*RST: CH2

DISPlay:XY:Y2Source <Source>

Defines an optional second source to be displayed in y-direction in an XY-diagram. The command is only relevant for 4-channel R&S RTM3000 instruments.

Parameters:

<Source> NONE | CH1 | CH2 | CH3 | CH4

*RST: NONE

16.8.6 Digital Voltmeter

The DVM suffix <m> sets the number of the DVM measurement (measurement place).

DVM<m>:ENABle.....	529
DVM<m>:SOURce.....	529
DVM<m>:TYPE.....	529
DVM<m>:RESult[:ACTual]?	529
DVM<m>:RESult[:ACTual]:STATus?	530

DVM<m>:ENABle <VoltmeterEnable>

Enables and disables all configured meter measurements.

Suffix:

<m> 1..4
The suffix is irrelevant.

Parameters:

<VoltmeterEnable> ON | OFF
*RST: OFF

DVM<m>:SOURce <Source>

Selects an analog channel as the source of the selected meter measurement.

Suffix:

<m> 1..4
Sets the number of the meter measurement.

Parameters:

<Source> CH1 | CH2 | CH3 | CH4
CH3 and CH4 are only available with 4-channel instruments.

DVM<m>:TYPE <MeasurementType>

Sets the measurement type for the indicated DVM measurement.

Set OFF to disable the measurement.

Suffix:

<m> 1..4
Sets the number of the meter measurement.

Parameters:

<MeasurementType> DC | ACDCrms | ACRMs | OFF
DC: mean value of the signal
ACDCrms: RMS value of the signal (AC+DC RMS)
ACRMs: RMS value of the signal's AC component (AC RMS)
OFF: disables the selected meter measurement.
*RST: OFF

DVM<m>:RESult[:ACTual]?

Returns the current value of the selected meter measurement.

Suffix:
 <m> 1..4
 Sets the number of the meter measurement.

Example:
 DVM2:SOUR CH2
 DVM2:TYPE DCRMs
 DVM2:RES?
 <-- 7.089E-01
 An RMS measurement is performed on measurement place 2, on channel 2. The result is 708.9 mV.

Usage: Query only

DVM<m>:RESult[:ACTual]:STATus?

Returns the result value and the status of the result.

The status is the decimal representation of a 4-bit register value:

- Bit 0 = 1: result is valid
- Bit 1 = 1: no result available
- Bit 2 = 1: clipping occurs
- Bit 3 = 1: no period found

Suffix:
 <m> 1..4
 Sets the number of the meter measurement.

Return values:
 <CurrentValue> Measured value
 <Status> Decimal status value

Example:
 DVM:SOUR CH1
 DVM:TYPE MEAN
 DVM:RES:STAT?
 <-- 4.968E-01,5
 The result value of the mean measurement on channel 1 is 496.1 mV. The result status is 5 (decimal) = 0101 (binary). That means, the result is valid (bit 0 = 1), and the signal is clipped by the limits of the ADC range (bit 3 = 1).

Usage: Query only

16.8.7 Trigger Counter

TCOUNTER:ENABLE.....	531
TCOUNTER:SOURce.....	531
TCOUNTER:RESult[:ACTual]:FREQuency?.....	531
TCOUNTER:RESult[:ACTual]:PERiod?.....	531

TCOUNTER:ENABle <Enable>

Enables or disables the trigger counter measurements.

Parameters:

<Enable> ON | OFF

TCOUNTER:SOURce

Sets the measurement source for the counter.

Parameters:

<CounterSource> CH1 | CH2 | CH3 | CH4 | TRIGger
TRIGger: Trigger source
*RST: TRIG

TCOUNTER:RESult[:ACTual]:FREQuency?

Returns the frequency of the trigger source.

Return values:

<FrequencyValue> Default unit: Hz

Usage: Query only

TCOUNTER:RESult[:ACTual]:PERiod?

Returns the period of the trigger source.

Return values:

<PeriodValue> Default unit: s

Usage: Query only

16.8.8 Bode Plot (Option R&S RTM-K36)

16.8.8.1 Bode Plot Setup

BPLot:ENABle.....	532
BPLot:AMPLitude:PROFile:COUNT.....	532
BPLot:AMPLitude:PROFile:POINt<n>:AMPLitude.....	532
BPLot:AMPLitude:PROFile:POINt<n>:FREQuency.....	532
BPLot:AMPLitude:MODE.....	532
BPLot:FREQuency:DATA?.....	533
BPLot:FREQuency:STARt.....	533
BPLot:FREQuency:STOP.....	533
BPLot:INPut[:SOURce].....	533
BPLot:MEASurement:DELay.....	533

BPLot:MEASurement:POINt[:DISPLAY].....	533
BPLot:OUTPut[:SOURce].....	534
BPLot:POINts:LOGarithmic.....	534
BPLot:REPeat.....	534
BPLot:RESet.....	534
BPLot:STATe.....	534

BPLot:ENABLE

Enables the Bode plot diagram.

Parameters:

<PlotEnable> ON | OFF
 *RST: OFF

BPLot:AMPLitude:PROFile:COUNT

Sets the number of different points that you can define for the amplitude profile.

Parameters:

<NumberOfPoints> Range: 2 to 16
 Increment: 1
 *RST: 4

BPLot:AMPLitude:PROFile:POINt<n>:AMPLitude

Sets the amplitude of the specified point of the amplitude profile.

Parameters:

<AmplitudeMode>

BPLot:AMPLitude:PROFile:POINt<n>:FREQuency

Sets the frequency of the specified point of the amplitude profile.

Parameters:

<Frequency>

BPLot:AMPLitude:MODE

Sets the amplitude mode.

Parameters:

<AmplitudeMode> CONStant | PROFil

CONStant

In the amplitude constant mode, there is a fixed amplitude for all frequencies.

PROFil

In the amplitude profile mode, you can define different amplitudes for different frequency.

*RST: CONS

BPLot:FREQuency:DATA?

Returns the data of the frequency waveform.

Parameters:

<FrequencyData>

Usage: Query only

BPLot:FREQuency:START

Sets the start frequency of the sweep for the Bode plot.

Parameters:

<StartFrequency> Range: 10 to 25e6
 Increment: 1
 *RST: 100

BPLot:FREQuency:STOP

Sets the stop frequency of the sweep for the Bode plot.

Parameters:

<StopFrequency> Range: 10 to 25e6
 Increment: 1
 *RST: 1e6

BPLot:INPut[:SOURce]

Selects the channel for the input signal of the DUT.

Parameters:

<InputSource> CH1 | CH2 | CH3 | CH4
 *RST: CH1

BPLot:MEASurement:DELay

Sets a time delay, that the system waits before measuring the next point of the bode plot.

Parameters:

<MeasDelay> Range: 0 to 10.0
 Increment: 0.01
 *RST: 0

BPLot:MEASurement:POINT[:DISPLAY]

Enables the display of the measurement points in the bode plot.

Parameters:

<PointDisplay> ON | OFF

BPLot:OUTPut[:SOURce]

Selects the channel for the output signal of the DUT.

Parameters:

<OutputSource> CH1 | CH2 | CH3 | CH4

*RST: CH2

BPLot:POINts:LOGarithmic

Sets the number of points per decade that are measured.

Parameters:

<PointsPerDecade> Range: 10 to 500

Increment: 1

*RST: 10

BPLot:REPeat

Repeats the measurement, using the same parameters.

Parameters:

<RepeatedMeasurement> ON | OFF

*RST: OFF

BPLot:RESet

Deletes all test results.

Usage: Event

BPLot:STATe

Starts the Bode plot measurement.

Parameters:

<PlotState> RUN | STOP

*RST: STOP

16.8.8.2 Bode Plot Diagram Settings

BPLot:GAIN:DATA?.....	535
BPLot:GAIN:ENABle.....	535
BPLot:GAIN:POSition.....	535
BPLot:GAIN:SCALe.....	535
BPLot:PHASe:DATA?.....	535

BPLot:PHASe:ENABle?.....	536
BPLot:PHASe:POSition?.....	536
BPLot:PHASe:SCALe?.....	536
BPLot:AMPLitude:ENABle.....	536
BPLot:AMPLitude:POSition.....	536
BPLot:AMPLitude:SCALe.....	537

BPLot:GAIN:DATA?

Returns the data of the gain waveform.

Parameters:

<GainData>

Usage: Query only

BPLot:GAIN:ENABle

Enables the gain waveform for the Bode plot.

Parameters:

<Enable> ON | OFF
 *RST: ON

BPLot:GAIN:POSition

Sets the vertical position of the gain waveform in divisions.

Parameters:

<WaveformPosition> Range: -20.0 to 20.0
 Increment: 0.1
 *RST: 3.0

BPLot:GAIN:SCALe

Sets the vertical scale for the gain waveform.

Parameters:

<WaveformScale> Range: 0.1 to 20.0
 Increment: 0.1
 *RST: 20.0

BPLot:PHASe:DATA?

Returns the data of the phase waveform.

Parameters:

<PhaseData>

Usage: Query only

BPLot:PHASe:ENABLE?

Enables the phase waveform for the Bode plot.

Parameters:

<Enable> ON | OFF
*RST: ON

Usage: Query only

BPLot:PHASe:POSition?

Sets the vertical position of the phase waveform in divisions.

Parameters:

<WaveformPosition> Range: -20.0 to 20.0
Increment: 0.1
*RST: 0.0

Usage: Query only

BPLot:PHASe:SCALE?

Sets the vertical scale for the phase waveform.

Parameters:

<WaveformScale> Range: 0.1 to 45.0
Increment: 0.1
*RST: 45.0

Usage: Query only

BPLot:AMPLitude:ENABLE

Enables the amplitude waveform for the Bode plot.

Parameters:

<Enable> ON | OFF
*RST: OFF

BPLot:AMPLitude:POSition

Sets the vertical position of the amplitude waveform in divisions.

Parameters:

<WaveformPosition> Range: -10.0 to 10.0
Increment: 0.1
*RST: -5.0

BPLot:AMPLitude:SCALE

Sets the vertical scale for the amplitude waveform.

Parameters:

<WaveformScale> Range: 0.1 to 2.0
 Increment: 0.001
 *RST: 1.0

16.8.8.3 Marker Table

BPLot:MARKer<m>:DIFFerence:FREQ?	537
BPLot:MARKer<m>:DIFFerence:GAIN?	537
BPLot:MARKer<m>:DIFFerence:PHASe?	537
BPLot:MARKer<m>:FREQuency	538
BPLot:MARKer<m>:GAIN?	538
BPLot:MARKer<m>:INDex	538
BPLot:MARKer<m>:PHASe?	538
BPLot:MARKer<m>:SSCReen	539

BPLot:MARKer<m>:DIFFerence:FREQ?

Returns the delta value of the frequency between the two markers.

Suffix:

<m> 1..2
 The suffix is irrelevant.

Parameters:

<FrequencyDifference>

Usage: Query only

BPLot:MARKer<m>:DIFFerence:GAIN?

Returns the delta value of the gain between the two markers.

Suffix:

<m> 1..2
 The suffix is irrelevant.

Parameters:

<GainDifference>

Usage: Query only

BPLot:MARKer<m>:DIFFerence:PHASe?

Returns the delta value of the phase between the two markers.

Suffix:

<m> 1..2
 The suffix is irrelevant.

Parameters:

<PhaseDifference>

Usage: Query only

BPLot:MARKer<m>:FREQuency

Returns the frequency for the specified marker.

Suffix:

<m> 1..2

Parameters:

<MarkerFrequency>

BPLot:MARKer<m>:GAIN?

Returns the gain for the specified marker.

Suffix:<m> 1..2
Selects the marker number.**Parameters:**

<PhaseValue>

Usage: Query only

BPLot:MARKer<m>:INDex

Returns the index for the specified marker.

Suffix:<m> 1..2
Selects the marker number.**Parameters:**

<Index>

BPLot:MARKer<m>:PHASe?

Returns the phase value for the specified marker.

Suffix:<m> 1..2
Selects the marker number.**Parameters:**

<GainValue>

Usage: Query only

BPLot:MARKer<m>:SSCRen

Resets the marker to their initial positions. This is helpful if the markers have disappeared from the display or need to be moved for a larger distance.

Suffix:

<m> 1..2

Usage: Event

16.9 Documenting Results

This chapter describes commands on how to transfer data from the instrument to a computer, how to export data to file, how to print and save screenshots, and how to manage measurement settings.

- [Transfer of Waveform Data](#)..... 539
- [Waveform Data Export to File](#)..... 551
- [Screenshots](#)..... 552
- [Instrument Settings: Mass MEMomory Subsystem](#)..... 554

16.9.1 Transfer of Waveform Data

This chapter describes data transfer commands that have effect on other commands in different applications of the instrument, and transfer commands that work in the same way.

16.9.1.1 Format Settings

FORMat[:DATA]	539
FORMat:BORDER	541

FORMat[:DATA] <DataFormat>,<Accuracy>

Defines the format for data export with

- [CHANnel<m>:DATA?](#) on page 541
- [CHANnel<m>:DATA:ENVELOpe?](#) on page 543
- [CALCulate:MATH<m>:DATA?](#) on page 545
- [REFCurve<m>:DATA?](#) on page 546

Parameters:

<DataFormat> ASCII | REAL | UINTEger

ASCII

List of values, for example, 1.23,1.22,1.24,.. File format for waveform export is TXT.

<Accuracy> is 0 which means that the instrument selects the number of digits to be returned. The query returns ASC,0.

REAL

Binary format. <Accuracy> is 32. The query returns REAL,32.

File format for waveform export is FLT.

The data is stored as binary data (Definite Length Block Data according to IEEE 488.2). Each waveform value is formatted in 32 Bit IEEE 754 Floating-Point-Format.

The schema of the result string is as follows:

#41024<value1><value2>...<value n> with:

#4 = number of digits of the following number (= 4 in the example)

1024 = number of following data bytes (= 1024 in the example)

<value> = 4-byte floating point values

UINTeger

Unsigned integer format, binary values with length 8 bit (1 byte per sample), 16 bit (2 bytes per sample) or 32 bit (4 bytes per sample): UINT, 8 or UINT, 16 or UINT, 32. File format for waveform export is BIN.

The data range for UINT, 8 is 0 to 255, the data range for

UINT, 16 is 0 to 65.535 and for UINT, 32 is $2^{32} - 1$.

The schema of the result string is the same as for REAL format.

For data conversion, you need the results of following commands:

...:DATA:XORigin?; ...:DATA:XINcrement?; ...:DATA:Yorigin?; ...:DATA:YINcrement?; ...:DATA:

YRESolution?. They are described below in this chapter. The way of data conversion is described in [Chapter 16.2.1.4, "Reading Waveform Data in Unsigned Integer Format"](#), on page 407.

32 bit data is relevant for average waveforms if averaging 512 or 1024 waveforms. The resulting data is 17 bits long (512 waveforms) or 18 bit (1024 waveforms).

CSV

Only for waveform export in CSV files. List of comma-separated values, for example, 1.23,1.22,1.24,..

<Accuracy> is 0 which means that the instrument selects the number of digits to be returned. The query returns CSV,0.

*RST: ASC

<Accuracy> 0 | 8 | 16 | 32

Length of a data value in bit

0 - for ASC only

32 - for REAL

8 | 16 | 32 - for UINT

*RST: 0

Example: Set the ASCII data format:

FORM ASC

Example: Query for data format:

FORM?

-> ASC,0

Example: Set the unsigned integer format, 16 bit data length:
FORM UINT, 16

FORMat:BORDER <ByteOrder>

Defines the byte order for binary data export if FORMat [: DATA] is set to REAL or UINT, 16 | 32.

Parameters:

<ByteOrder>

MSBFirst | LSBFirst

MSBFirst

Big endian, most significant byte first

LSBFirst

Little endian, least significant byte first

*RST: MSBF

Example: [Reading Waveform Data in Real Format](#)

ByteOrder	8 bit	16 bit	32 bit
MSBF	0xab	0xAB CD	0xAB CD 00 00
LSBF	not relevant	0xCD AB	0x00 00 CD AB

16.9.1.2 Analog Channels

CHANnel<m>:DATA?.....	541
CHANnel<m>:DATA:HEADer?.....	542
CHANnel<m>:DATA:POINts.....	542
CHANnel<m>:DATA:ENVELOpe?.....	543
CHANnel<m>:DATA:ENVELOpe:HEADer?.....	544

CHANnel<m>:DATA?

Returns the data of the analog channel waveform for transmission from the instrument to the controlling computer. The waveforms data can be used in MATLAB, for example.

To set the export format, use FORMat [: DATA] on page 539.

To set the range of samples to be returned, use CHANnel<m>:DATA:POINts.

For envelope waveforms, use the CHANnel<m>:DATA:ENVELOpe? command.

Suffix:

<m>

1..4

Selects the input channel. The number of channels depends on the instrument.

Return values:

<Data>

List of values according to the format settings - the voltages of recorded waveform samples.

Example: FORM ASC
 CHAN1:DATA?
 -0.125000,-0.123016,-0.123016,-0.123016,
 -0.123016,-0.123016,...

Example: See [Chapter 16.2.1.3, "Reading Waveform Data in Real Format"](#), on page 407 and [Chapter 16.2.1.4, "Reading Waveform Data in Unsigned Integer Format"](#), on page 407

Usage: Query only

CHANnel<m>:DATA:HEADer?

Returns information on the channel waveform. For envelope waveforms, use the [CHANnel<m>:DATA:ENVELOpe:HEADer?](#) command.

Table 16-1: Header data

Position	Meaning	Example
1	XStart in s	-9.477E-008 = -94,77 ns
2	XStop in s	9.477E-008 = 94,77 ns
3	Record length of the waveform in Samples	120000
4	Number of values per sample interval, usually 1.	1

Suffix:

<m> 1..4
 Selects the input channel. The number of channels depends on the instrument.

Parameters:

<DataHeader> Comma-separated value list
 Example: -9.477E-008,9.477E-008,120000,1

Usage: Query only

CHANnel<m>:DATA:POINts <PointSelection>

As a setting, the command selects a range of samples that will be returned with [CHANnel<m>:DATA?](#) and [CHANnel<m>:DATA:ENVELOpe?](#). As a query, it returns the number of returned samples for the selected range.

Depending on the current settings, the memory can contains more data samples than the screen is able to display. In this case, you can decide which data will be saved: samples stored in the memory or only the displayed samples.

Note: The sample range can only be changed in STOP mode. If the acquisition is running, DEF is always used automatically. If the acquisition has been stopped, data can be read from the memory, and all settings are available.

Suffix:

<m> 1..4
The command affects all channels, and the suffix is irrelevant.

Setting parameters:

<PointSelection> DEFault | MAXimum | DMAXimum
Sets the range for data queries.

DEFault

Waveform points that are visible on the screen. At maximum waveform rate, the instrument stores more samples than visible on the screen, and DEF returns less values than acquired.

MAXimum

All waveform samples that are stored in the memory. Only available if acquisition is stopped.

DMAXimum

Display maximum: Waveform samples stored in the current waveform record but only for the displayed time range. At maximum waveform rate, the instrument stores more samples than visible on the screen, and DMAX returns more values than DEF. Only available if acquisition is stopped.

*RST: DEFault

Return values:

<Points> Number of data points in the selected range.
Default unit: Samples

Example:

```
CHAN:DATA:POIN DEF
CHAN:DATA:POIN?;:CHAN2:DATA:POIN?
Returned values: 10416;10416
CHAN:DATA:POIN DMAX
CHAN:DATA:POIN?;:CHAN2:DATA:POIN?
Returned values: 124992;124992
CHAN:DATA:POIN MAX
CHAN:DATA:POIN?;:CHAN2:DATA:POIN?
Returned values: 4194302;4194302
```

Example:

See [Chapter 16.2.1.3, "Reading Waveform Data in Real Format"](#), on page 407

CHANnel<m>:DATA:ENVELOpe?

Returns the data of the envelope. The envelope consists of two waveforms. The waveforms data can be used in MATLAB, for example.

Use this command only for envelope waveforms. For other channel waveforms use [CHANnel<m>:DATA?](#).

To set the export format, use [FORMat \[:DATA \]](#).

To set the range of samples to be returned, use [CHANnel<m>:DATA:POINTs](#).

Suffix:

<m> 1..4
Selects the input channel. The number of channels depends on the instrument.

Parameters:

<EnvelopeData> List of values according to the format settings - the voltages of the envelope points. The list contains two values for each sample interval.

Usage: Query only

CHANnel<m>:DATA:ENVELOpe:HEADer?

Returns information on the envelope waveform.

Use this command only for envelope waveforms. For all other channel waveforms use [CHANnel<m>:DATA:HEADer?](#).

Table 16-2: Header data

Position	Meaning	Example
1	XStart in s	-9.477E-008 = - 94,77 ns
2	XStop in s	9.477E-008 = 94,77 ns
3	Number of samples	120000
4	Number of values per sample interval. For envelope waveforms the value is 2.	2

Suffix:

<m> 1..4
Selects the input channel. The number of channels depends on the instrument.

Parameters:

<EnvelopeHeader> Comma-separated value list
Example: -9.477E-008, 9.477E-008, 200000, 2

Usage: Query only

16.9.1.3 Math Waveforms

In addition to the commands described below, consider also the following commands:

- [CALCulate:MATH<m>:DATA:XINCrement?](#) on page 549
- [CALCulate:MATH<m>:DATA:XORigin?](#) on page 548
- [CALCulate:MATH<m>:DATA:YINCrement?](#) on page 550
- [CALCulate:MATH<m>:DATA:YORigin?](#) on page 549
- [CALCulate:MATH<m>:DATA:YRESolution?](#) on page 550

CALCulate:MATH<m>:DATA?

Returns the data of the math waveform points for transmission from the instrument to the controlling computer. The waveforms data can be used in MATHLAB, for example.

To set the export format, use [FORMat \[:DATA\]](#) on page 539.

Suffix:

<m> 1..5

Return values:

<Data> List of values according to the format settings - voltages, or magnitudes of a spectrum.

Usage: Query only

CALCulate:MATH<m>:DATA:HEADer?

Returns information on the math waveform.

Table 16-3: Header data

Position	Meaning	Example
1	XStart in s	-9.477E-008 = - 94,77 ns
2	XStop in s	9.477E-008 = 94,77 ns
3	Record length of the waveform in Samples	120000
4	Number of values per sample interval, usually 1.	1

Suffix:

<m> 1..5

Return values:

<Header> Comma-separated value list
Example: -9.477E-008, 9.477E-008, 120000, 1

Usage: Query only

CALCulate:MATH<m>:DATA:POINts?

Returns the number of data samples that are returned with [CALCulate:MATH<m>:DATA?](#).

Suffix:

<m> 1..5
Selects the math waveform.

Return values:

<DataPoints> Number of data points

Usage: Query only

16.9.1.4 Reference Waveforms

In addition to the commands described below, consider also the following commands:

- [REFCurve<m>:DATA:XINCrement?](#) on page 549
- [REFCurve<m>:DATA:XORigin?](#) on page 548
- [REFCurve<m>:DATA:YINCrement?](#) on page 550
- [REFCurve<m>:DATA:YORigin?](#) on page 549
- [REFCurve<m>:DATA:YRESolution?](#) on page 550

REFCurve<m>:DATA?

Returns the data of the reference waveform for transmission from the instrument to the controlling computer. The waveforms data can be used in MATLAB, for example.

To set the export format, use [FORMat \[:DATA\]](#) on page 539.

Suffix:

<m> 1..4
Selects the reference waveform, the internal reference storage.

Return values:

<Data> List of values according to the format settings.

Usage: Query only

REFCurve<m>:DATA:HEADer?

Returns information on the reference waveform.

Table 16-4: Header data

Position	Meaning	Example
1	XStart in s	-9.477E-008 = - 94,77 ns
2	XStop in s	9.477E-008 = 94,77 ns
3	Record length of the waveform in Samples	200000
4	Number of values per sample interval, usually 1.	1

Suffix:

<m> 1..4
Selects the reference waveform, the internal reference storage.

Parameters:

<Header> Comma-separated value list
Example: -9.477E-008, 9.477E-008, 200000, 1

Usage: Query only

16.9.1.5 Masks

In addition to the commands described below, consider also the following commands:

- [MASK:DATA:XINCrement?](#) on page 549
- [MASK:DATA:XORigin?](#) on page 548
- [MASK:DATA:YINCrement?](#) on page 550
- [MASK:DATA:YORigin?](#) on page 549
- [MASK:DATA:YRESolution?](#) on page 550

MASK:DATA?

Returns the data of the mask. The mask consists of two limit curves.

To set the export format, use [FORMat \[:DATA\]](#) on page 539.

Return values:

<Data> List of values according to the format settings - the y-values of the mask points. The list contains two values for each sample interval.

Usage: Query only

MASK:DATA:HEADer?

Returns information on the mask data that is delivered with [MASK:DATA?](#).

Table 16-5: Header data

Position	Meaning	Example
1	XStart in s	-9.477E-008 = - 94,77 ns
2	XStop in s	9.477E-008 = 94,77 ns
3	Number of samples	200000
4	Number of values per sample interval. For masks the value is 2.	2

Return values:

<DataHeader> Comma-separated value list
Example: -9.477E-008, 9.477E-008, 200000, 2

Usage: Query only

16.9.1.6 Logic Channels

See [Chapter 16.13.1.3, "Logic Channels - Waveform Data"](#), on page 741

16.9.1.7 Parameters for Data Evaluation

To analyze waveform data, you need some parameters, which are queried using the following commands.

CHANnel<m>:DATA:XORigin?	548
CHANnel<m>:DATA:ENvelope:XORigin?	548
CALCulate:MATH<m>:DATA:XORigin?	548
MASK:DATA:XORigin?	548
LOGic<p>:DATA:XORigin?	548
DIGital<m>:DATA:XORigin?	548
REFCurve<m>:DATA:XORigin?	548
CHANnel<m>:DATA:XINCrement?	549
CHANnel<m>:DATA:ENvelope:XINCrement?	549
CALCulate:MATH<m>:DATA:XINCrement?	549
MASK:DATA:XINCrement?	549
LOGic<p>:DATA:XINCrement?	549
DIGital<m>:DATA:XINCrement?	549
REFCurve<m>:DATA:XINCrement?	549
CHANnel<m>:DATA:YORigin?	549
CHANnel<m>:DATA:ENvelope:YORigin?	549
CALCulate:MATH<m>:DATA:YORigin?	549
MASK:DATA:YORigin?	549
LOGic<p>:DATA:YORigin?	549
DIGital<m>:DATA:YORigin?	549
REFCurve<m>:DATA:YORigin?	549
CHANnel<m>:DATA:YINCrement?	550
CHANnel<m>:DATA:ENvelope:YINCrement?	550
CALCulate:MATH<m>:DATA:YINCrement?	550
MASK:DATA:YINCrement?	550
LOGic<p>:DATA:YINCrement?	550
DIGital<m>:DATA:YINCrement?	550
REFCurve<m>:DATA:YINCrement?	550
CHANnel<m>:DATA:YRESolution?	550
CHANnel<m>:DATA:ENvelope:YRESolution?	550
CALCulate:MATH<m>:DATA:YRESolution?	550
MASK:DATA:YRESolution?	550
LOGic<p>:DATA:YRESolution?	550
DIGital<m>:DATA:YRESolution?	550
REFCurve<m>:DATA:YRESolution?	550

CHANnel<m>:DATA:XORigin?
CHANnel<m>:DATA:ENvelope:XORigin?
CALCulate:MATH<m>:DATA:XORigin?
MASK:DATA:XORigin?
LOGic<p>:DATA:XORigin?
DIGital<m>:DATA:XORigin?
REFCurve<m>:DATA:XORigin?

Return the time of the first sample of the indicated waveform.

The commands are relevant for data conversion if binary data format is defined ([FORM UINT, 8 | 16 | 32](#)).

Suffix:

<m> 1..4

Return values:

<Xorigin> Time in s

Example:

See [Chapter 16.2.1.4, "Reading Waveform Data in Unsigned Integer Format"](#), on page 407

Usage:

Query only

CHANnel<m>:DATA:XINCrement?

CHANnel<m>:DATA:ENVELOpe:XINCrement?

CALCulate:MATH<m>:DATA:XINCrement?

MASK:DATA:XINCrement?

LOGic<p>:DATA:XINCrement?

DIGital<m>:DATA:XINCrement?

REFCurve<m>:DATA:XINCrement?

Return the time difference between two adjacent samples of the indicated waveform.

The commands are relevant for data conversion if binary data format is defined ([FORM UINT, 8 | 16 | 32](#)).

Suffix:

<m> 1..4

Return values:

<Xincrement> Time in s

Example:

See [Chapter 16.2.1.4, "Reading Waveform Data in Unsigned Integer Format"](#), on page 407

Usage:

Query only

CHANnel<m>:DATA:YORigin?

CHANnel<m>:DATA:ENVELOpe:YORigin?

CALCulate:MATH<m>:DATA:YORigin?

MASK:DATA:YORigin?

LOGic<p>:DATA:YORigin?

DIGital<m>:DATA:YORigin?

REFCurve<m>:DATA:YORigin?

Return the voltage value for binary value 0 of the indicated waveform.

The commands are relevant for data conversion if binary data format is defined ([FORM UINT, 8 | 16 | 32](#)).

Suffix:

<m> 1..4

Return values:

<Yorigin> Voltage in V

Example:

See [Chapter 16.2.1.4, "Reading Waveform Data in Unsigned Integer Format"](#), on page 407

Usage:

Query only

CHANnel<m>:DATA:YINCrement?

CHANnel<m>:DATA:ENVELOpe:YINCrement?

CALCulate:MATH<m>:DATA:YINCrement?

MASK:DATA:YINCrement?

LOGic<p>:DATA:YINCrement?

DIGital<m>:DATA:YINCrement?

REFCurve<m>:DATA:YINCrement?

Return the voltage value per bit of the indicated waveform.

The commands are relevant for data conversion if binary data format is defined ([FORM UINT, 8|16|32](#)).

Suffix:

<m> 1..4

Return values:

<Yincrement> Voltage in V

Example:

See [Chapter 16.2.1.4, "Reading Waveform Data in Unsigned Integer Format"](#), on page 407

Usage:

Query only

CHANnel<m>:DATA:YRESolution?

CHANnel<m>:DATA:ENVELOpe:YRESolution?

CALCulate:MATH<m>:DATA:YRESolution?

MASK:DATA:YRESolution?

LOGic<p>:DATA:YRESolution?

DIGital<m>:DATA:YRESolution?

REFCurve<m>:DATA:YRESolution?

Return the vertical bit resolution of the indicated waveform.

The commands are relevant for data conversion if binary data format is defined ([FORM UINT, 8|16|32](#)).

Suffix:

<m> 1..4

Return values:

<Yresolution> For default waveforms, the resolution is 8 bit.
If high resolution, average or filter are set for the waveform, the resolution is 16 bit.

Example:

See [Chapter 16.2.1.4, "Reading Waveform Data in Unsigned Integer Format"](#), on page 407

Usage: Query only

16.9.2 Waveform Data Export to File

<code>EXPort:WAVeform:SOURce</code>	551
<code>EXPort:WAVeform:NAME</code>	551
<code>EXPort:WAVeform:SAVE</code>	551

EXPort:WAVeform:SOURce <WaveformSource>

Defines the waveform to be exported.

Parameters:

<WaveformSource> CH1..4 | D70 | D158 | MA1 | RE1..4

CH1..4

Analog channels CH1 | CH2 | CH3 | CH4

D70

Pod 1, digital channels D0 to D7 are exported together

D158

Pod 2, digital channels D8 to D15 are exported together.

MA1..5

Mathematic waveforms MA1 | MA2 | MA3 | MA4 | MA5

RE1..4

Reference waveforms RE1 | RE2 | RE3 | RE4

EXPort:WAVeform:NAME <FileName>

Defines the path and filename for a waveform data file that will be saved with `EXPort:WAVeform:SAVE`. The data format and file extension is defined using `FORMat[:DATA]`.

Existing files will be overwritten.

You can change the storage location, file name and/or file format manually in the [File] > "Waveforms" menu. Remote control uses the recent settings.

Parameters:

<FileName> String parameter

Example:

```
FORMAT CSV
EXPort:WAVeform:NAME "/USB_FRONT/WAVEFORMS/WFM01"
EXPort:WAVeform:SAVE
```

The waveform data is saved to WFM01.CSV.

EXPort:WAVeform:SAVE

Executes saving a waveform, for which the path and filename have been defined by `EXPort:WAVeform:NAME`.

Usage: Event

16.9.3 Screenshots

This chapter describes remote commands used to save screenshots.

MMEMory:NAME	552
HCOPy:CWINdow	552
HCOPy[:IMMEDIATE]	552
HCOPy:DATA?	553
HCOPy:FORMat	553
HCOPy:LANGUage	553
HCOPy:SIZE:X?	553
HCOPy:SIZE:Y?	553
HCOPy:COLor:SCHeme	553

MMEMory:NAME <file_name>

Defines the file name to store an image of the display with [HCOPy\[:IMMEDIATE\]](#).

Parameters:

<Filename> String parameter

Example: See [Chapter 16.2.1.1, "Saving Screenshots to File"](#), on page 405

HCOPy:CWINdow <CloseWindow>

If ON, open dialog boxes and menus are closed before the screenshot is saved. Thus, the waveforms and results are always visible on the screenshot.

Parameters:

<CloseWindow> ON | OFF
*RST: ON

HCOPy[:IMMEDIATE]

Saves a screenshot to the specified file.

Before starting, make sure that:

- The path for storage is defined correctly by [MMEMory:CDIRectory](#)
- The file name for storage is defined by [MMEMory:NAME](#).

Example: See [Chapter 16.2.1.1, "Saving Screenshots to File"](#), on page 405

Usage: Event

HCOPY:DATA?

Returns the data of the image file. The file format is defined using [HCOPY:LANGUage](#) (BMP | PNG)

Return values:

<ScreenShot> 488.2 block data

Usage: Query only

HCOPY:FORMat <Format>**HCOPY:LANGUage <Format>**

Defines the format of the screenshot.

Parameters:

<Format> BMP | PNG | GIF

BMP: Windows Bitmap Format

PNG: Portable Network Graphic

GIF: Graphics interchange format

*RST: PNG

Example: See [Chapter 16.2.1.1, "Saving Screenshots to File"](#), on page 405

HCOPY:SIZE:X?

Returns the number of horizontal pixels of the oscilloscope screen.

Return values:

<Xsize> Numeric value

Usage: Query only

HCOPY:SIZE:Y?

Returns the number of vertical pixels of the oscilloscope screen.

Return values:

<Ysize> Numeric value

Usage: Query only

HCOPY:COLor:SCHeme <ColorScheme>

Defines the color mode for screenshots.

Parameters:

<ColorScheme> COLor | GRAYscale | INVerted

INVerted inverts the colors of the output, i.e. a dark waveform is depicted on a white background.

*RST: COLor

Example: see [Chapter 16.2.1.1, "Saving Screenshots to File"](#), on page 405

16.9.4 Instrument Settings: Mass MEMomory Subsystem

The Mass MEMomory subsystem provides commands to access the storage media and to save and reload instrument settings and data.

The R&S RTM3000 has the following storage devices indicated as drives:

- /INT: internal storage with default directories for each data type
- /USB_FRONT: USB connector on the front panel
- /USB_REAR: USB connector on the rear panel

Common computer and network drives like C:, D:, \\server\share are not available.

Name conventions

The names of files and directories have to meet the following rules:

- Only the 8.3 format with ASCII characters is supported.
- No special characters are allowed.
- Use / (slash) instead of \ (backslash).

MMEMory:DRIVes?	554
MMEMory:MSIS	555
MMEMory:MDIRectory	555
MMEMory:CDIRectory	555
MMEMory:RDIRectory	556
MMEMory:DCATalog?	556
MMEMory:DCATalog:LENGth?	557
MMEMory:CATalog?	557
MMEMory:CATalog:LENGth?	558
MMEMory:COpy	558
MMEMory:MOVe	558
MMEMory:DELeTe	559
MMEMory:DATA	559
MMEMory:STORe:STATe	560
MMEMory:LOAD:STATe	560

MMEMory:DRIVes?

Returns the storage devices available on the R&S RTM3000.

Parameters:

<Drive> List of strings, for example, ""/INT"", ""/USB_FRONT""
 /INT: internal storage
 /USB_FRONT: USB connector on the front panel
 /USB_REAR: USB connector on the rear panel

Usage: Query only

MMEemory:MSIS <Drive>

Changes the default storage location (drive).

Parameters:

<Drive> One of the available drives: /INT, or /USB_FRONT

Example:

```
MMEM:MSIS '/USB_FRONT'
```

Sets the USB flash drive connected to the front panel as storage location.

MMEemory:MDIRectory <DirectoryName>

Creates a new directory with the specified name.

Setting parameters:

<DirectoryName> String parameter
 Absolute path including the storage device, or relative to the current directory.

Example:

Create directory DATA on the front USB flash device, with absolute path:

```
MMEM:MDIR "/USB_FRONT/DATA"
```

Example:

Create directory JANUARY in the DATA directory, with relative path:

```
MMEM:CDIR "/USB_FRONT/DATA/"
MMEM:MDIR "JANUARY"
```

Usage: Setting only

MMEemory:CDIRectory <DirectoryName>

Specifies the current directory for file access. Before using the command, create the directory with [MMEemory:MDIRectory](#).

Setting parameters:

<DirectoryName> String parameter to specify the directory, including the storage device.

Example:

```
MMEM:CDIR "/USB_FRONT/DATA"
```

Example:

[Chapter 16.2.1.2, "Saving, Copying, and Loading Setup Data"](#), on page 406

MMEemory:RDIRectory <DirectoryName>

Deletes the specified directory.

Note: All subdirectories and all files in the specified directory and in the subdirectories will be deleted!

You cannot delete the current directory or a superior directory. In this case, the instrument returns an execution error.

Setting parameters:

<DirectoryName> String parameter, absolute path or relative to the current directory

Example:

```
MMEemory:RDIR "/INT/TEST"
```

Deletes the directory TEST in the internal storage device, and all files and subdirectories in the directory.

Usage:

Setting only

MMEemory:DCATalog? <PathName>

Returns the subdirectories of the specified directory. The result corresponds to the number of strings returned by the `MMEemory:DCATalog:LENGth?` command.

Query parameters:

<PathName> String parameter
Specifies the directory.

Return values:

<FileEntry> String parameter
List of subdirectory strings separated by commas. If the specified directory does not have any subdirectory, the current and the parent directories are returned ("`. , 0`", "`. . . , 0`")

Example:

Query for directories with absolute path:

```
MMEemory:DCAT? "/USB_FRONT/*"
```

```
received ". , 0", ". . . , 0", "DATA , 0", "DATA_NEW , , 0", "SCREENSHOTS , , 0"
```

```
MMEemory:DCAT:LENG? "/USB_FRONT/*"
```

```
received 5
```

Example:

Query for directories in the current directory:

```
MMEemory:CDIR "/USB_FRONT/DATA/"
```

```
MMEemory:DCAT? "*"
```

```
received ". , 0", ". . . , 0", "JANUARY , , 0", "FEBRUARY , , 0"
```

```
MMEemory:DCAT:LENG? "*"
```

```
received 4
```

Example: Query with filter:
 MMEM:DCAT? "/USB_FRONT/DA*"

received "DATA,,0","DATA_NEW,,0"

MMEM:DCAT:LENG? "/USB_FRONT/DA*"

received 2

Usage: Query only

MMEMory:DCATalog:LENGth? <PathName>

Returns the number of directories in specified directory. The result corresponds to the number of strings returned by the MMEMory:DCATalog? command.

Query parameters:

<PathName> String parameter
 Specifies the directory.

Return values:

<DirCount> Number of directories.

Example: [MMEMory:DCATalog?](#)

Usage: Query only

MMEMory:CATalog? <PathName>[,<Format>]

Returns the a list of files contained in the specified directory. The result corresponds to the number of files returned by the MMEMory:CATalog:LENGth? command.

Query parameters:

<PathName> String parameter
 Specifies the directory. A filter can be used to list, for example, only files of a given file type.

<Format> ALL | WTIME
 ALL: Extended result including file, date, time and attributes
 WTIME: Result including file, date, time

Return values:

<UsedMemory> Total amount of storage currently used in the directory, in bytes.

<FreeMemory> Total amount of storage available in the directory, in bytes.

<FileEntry> String parameter
 All files of the directory are listed with their file name, format and size in bytes.

Example: Query for files in the DATA directory, with absolute path:

```
MMEM:CAT? "/USB_FRONT/DATA/*.*"
received: 511104,8633856,"MONDAY.TXT,,8",
"TUESDAY.CSV,,8"
```

Example: Query for TXT files in the DATA directory, with relative path:
 MMEM:CDIR "/USB_FRONT/DATA" '
 MMEM:CAT? "*.TXT"
 received: 511104,8633856,"MONDAY.TXT",,8"
 MMEM:CAT:LENGTH? "*.TXT"
 received 1

Example: [Chapter 16.2.1.2, "Saving, Copying, and Loading Setup Data"](#), on page 406

Usage: Query only

MMEMory:CATalog:LENGth? <PathName>

Returns the number of files in the specified directory. The result corresponds to the number of files returned by the `MMEMory:CATalog?` command.

Query parameters:

<PathName> String parameter
 Directory to be queried, absolute or relative path

Return values:

<Count> Number of files.

Example: [MMEMory:CATalog?](#)

Usage: Query only

MMEMory:COpy <FileSource>,<FileDestination>

Copies data to another directory on the same or different storage device. The file name can be changed, too.

Setting parameters:

<FileSource> String parameter
 Name and path of the file to be copied

<FileDestination> String parameter
 Name and path of the new file. If the file already exists, it is overwritten without notice.

Example: MMEM:COpy "/INT/SETTINGS/SET001.SET",
 "/USB_FRONT/SETTINGS/TESTSET1.SET"

Example: [Chapter 16.2.1.2, "Saving, Copying, and Loading Setup Data"](#), on page 406

Usage: Setting only

MMEMory:MOve <FileSource>,<FileDestination>

Moves an existing file to a new location.

Setting parameters:

<FileSource> String parameter
Path and name of the file to be moved

<FileDestination> String parameter
Path and name of the new file

Example: MMEM:MOVE "/INT/SETTINGS/SET001.SET",
"/USB_FRONT/SETTINGS/SET001.SET"

Usage: Setting only

MMEMory:DELeTe <FileSource>

Removes a file from the specified directory.

Setting parameters:

<FileSource> String parameter
File name and path of the file to be removed. If the path is omitted, the specified file will be deleted in the current directory. Filters are not allowed.

Example: [Chapter 16.2.1.2, "Saving, Copying, and Loading Setup Data"](#), on page 406

Usage: Setting only

MMEMory:DATA <FileName>,<Data>

Writes data to the specified file in the current directory [MMEMory:CDIRectory](#), or reads the data.

Parameters:

<Data> 488.2 block data
The block begins with character '#'. The next digit is the length of the length information, followed by this given number of digits providing the number of bytes in the binary data attached.

Parameters for setting and query:

<FileName> String parameter containing the file name

Example: MMEM:DATA "abc.txt", #216This is the file
#2: the length information has two digits
16: the binary data has 16 bytes.
MMEM:DATA? "abc.txt"
received: This is the file

Example: [Chapter 16.2.1.2, "Saving, Copying, and Loading Setup Data"](#), on page 406

MMEMory:STORe:STATe <StateNumber>,<FileName>

Saves the current device settings to the specified file in the current directory.

Setting parameters:

<StateNumber> Range: 1 to 1
 Increment: 0
 *RST: 1

<FileName> String parameter
 File name, with or without file extension

Example: MMEM:CDIR "/USB_FRONT/DATA" '
 MMEM:STOR:STAT 1, "MORNING.SET"

Example: See [Chapter 16.2.1.2, "Saving, Copying, and Loading Setup Data"](#), on page 406

Usage: Setting only

MMEMory:LOAD:STATe <StateNumber>,<FileName>

Loads the device settings from the specified file in the current directory.

Setting parameters:

<StateNumber> Range: 1 to 1
 Increment: 0
 *RST: 1

<FileName> String parameter
 File name, with or without file extension

Example: MMEM:CDIR "/USB_FRONT/DATA" '
 MMEM:LOAD:STAT 1, "MORNING"

Example: See [Chapter 16.2.1.2, "Saving, Copying, and Loading Setup Data"](#), on page 406

Usage: Setting only

16.10 General Instrument Setup

- [Display Settings](#)..... 561
- [System Settings](#)..... 565
- [LAN Settings](#)..... 569
- [USB Settings](#)..... 571
- [Trigger Out](#)..... 572
- [Firmware Update](#)..... 572

16.10.1 Display Settings

DISPlay:LANGUage.....	561
DISPlay:DTIME.....	561
DISPlay:CLEar[:SCReen].....	561
DISPlay:PERsistence:TYPE.....	562
DISPlay:PERsistence:TIME.....	562
DISPlay:PERsistence:CLEar.....	562
DISPlay:PERsistence[:STATE].....	562
DISPlay:PERsistence:INFinite.....	563
DISPlay:DIALog:CLOSe.....	563
DISPlay:DIALog:MESSage.....	563
DISPlay:GRID:STYLe.....	563
DISPlay:INTensity:BACKlight.....	564
DISPlay:INTensity:GRID.....	564
DISPlay:INTensity:WAVEform.....	564
DISPlay:PALette.....	564
DISPlay:STYLe.....	565
DISPlay:GRID:ANNotation[:ENABLE].....	565
DISPlay:GRID:ANNotation:TRACk.....	565

DISPlay:LANGUage <Language>

Selects the language in which the button labels and other screen information is displayed.

Parameters:

<Language> ENGLISH | GERMan | FRENch | SPANish | RUSSian |
 SCHinese | TCHinese | JAPANese | KORean | ITALian |
 PORTuguese | CZECh | POLish

Supported languages are listed in the "Specifications" data sheet.

*RST: ENGL

DISPlay:DTIME <DateTimeVisible>

Switches the date and time display in the upper right corner of the screen on or off.

Parameters:

<DateTimeVisible> ON | OFF

DISPlay:CLEar[:SCReen]

Deletes all waveforms and measurement results.

Usage: Event

DISPlay:PERSistence:TYPE <Type>

Defines how long every new data point remains on the screen.

Parameters:

<Type>	OFF TIME INFinite
	OFF
	Deactivates persistence.
	TIME
	Data points remain on the screen for the duration defined with DISPlay:PERSistence:TIME .
	INF
	Data points remain on the screen infinitely until persistence is set to OFF.
*RST:	OFF

DISPlay:PERSistence:TIME <Time>

Persistence time if persistence is active ([DISPlay:PERSistence\[:STATe\]](#) is set to TIME).

Each new data point in the diagram area remains on the screen for the duration defined here. .

Parameters:

<Time>	Persistence time
	Range: 50e-3 to 12.8
	Increment: 50e-3
	*RST: 50e-3
	Default unit: s

DISPlay:PERSistence:CLEar

Removes the displayed persistent waveform from the screen.

Usage: Event

DISPlay:PERSistence[:STATe] <State>

Defines whether the waveform persists on the screen or whether the screen is refreshed continuously.

Parameters:

<State>	ON OFF
	ON
	The waveform persists for the time defined using DISPlay:PERSistence:TIME .

OFF

The waveform does not persist on the screen. Only the currently measured values are displayed.

*RST: OFF

DISPlay:PERsistence:INFinite <InfinitePersistence>

Sets the persistence time to infinite if `DISPlay:PERsistence[:STATE]` is ON. each new data point remains on the screen infinitely until this setting is changed or the persistence is cleared.

Parameters:

<InfinitePersistence> ON | OFF

*RST: OFF

DISPlay:DIALog:CLOSe

Closes an open message box.

Usage: Event

DISPlay:DIALog:MESSage <MessageText>

Sends a message text to the instrument and displays it in a message box.

To close the message box, use `DISPlay:DIALog:CLOSe`.

Setting parameters:

<MessageText> String

String that contains the message.

Example: `DISP:DIAL:MESS 'My message'`
`DISP:DIAL:CLOS`

Usage: Setting only

DISPlay:GRID:STYLe <Style>

Defines how the grid is displayed.

Parameters:

<Style> LINES | RETicle | NONE

LINES

Displays the grid as horizontal and vertical lines.

RETicle

Displays crosshairs instead of a grid.

NONE

No grid is displayed.

*RST: LIN

DISPlay:INTensity:BACKlight <Intensity>

Defines the intensity of illuminated front panel keys and rotary knobs.

Parameters:

| | |
|-------------|---|
| <Intensity> | Value in percent |
| | Range: 10 to 100 |
| | Increment: 1 |
| | *RST: not available, *RST does not change the intensity |
| | Default unit: % |

DISPlay:INTensity:GRID <Intensity>

Defines the brightness of the grid lines in the diagram.

Parameters:

| | |
|-------------|---|
| <Intensity> | Range: 0 to 100 |
| | Increment: 1 |
| | *RST: not available, *RST does not change the intensity |
| | Default unit: % |

DISPlay:INTensity:WAVeform <Intensity>

Defines the brightness of the waveform lines in the diagram.

Parameters:

| | |
|-------------|---|
| <Intensity> | Range: 0 to 100 |
| | Increment: 1 |
| | *RST: not available, *RST does not change the intensity |
| | Default unit: % |

DISPlay:PALETTE <Palette>

Sets the color and brightness of the displayed waveform samples depending on their cumulative occurrence.

Parameters:

| | |
|-----------|------------------|
| <Palette> | NORMAL INVerse |
|-----------|------------------|

NORMAL
Values that occur frequently are brighter than rare values.

INVerse
Rare values are brighter than frequent values, inverse to the NORMAL brightness.

FColor
Rare values are displayed in blue, while more frequent values are red and very frequent values are displayed in yellow or white, with various colors inbetween.

IFColor

Inverses the FColor setting: rare values are yellow or white while frequent values are blue.

*RST: NORM

DISPlay:STYLe <Style>

Defines how the waveform data is displayed

Parameters:

<Style> VECTors | DOTS

VECTors

Individual data points are connected by a line.

DOTS

Only the data points are displayed.

*RST: VECT

DISPlay:GRID:ANNotation[:ENABle] <State>

Enables or disables the display of scale values and units for the x-axis and y-axis at the grid lines.

Parameters:

<State> ON | OFF

*RST: ON

DISPlay:GRID:ANNotation:TRACk <State>

If enabled, the grid moves with the waveforms, if you change the waveform's position in horizontal or vertical direction.

If disabled, the grid remains centered on the display, if you change the waveform's position.

Parameters:

<State> ON | OFF

*RST: OFF

16.10.2 System Settings

| | |
|--|-----|
| CALibration..... | 566 |
| CALibration:STATe?..... | 566 |
| SYSTem:NAME..... | 566 |
| SYSTem:DATE..... | 566 |
| SYSTem:TIME..... | 567 |
| SYSTem:COMMunicate:INTerface[:SELeCt]..... | 567 |
| SYSTem:BEEPer:CONTRol:STATe..... | 567 |
| SYSTem:BEEPer:ERRor:STATe..... | 567 |

| | |
|--------------------------------|-----|
| SYSTem:BEEPer:TRIG:STATe..... | 568 |
| SYSTem:BEEPer[:IMMediate]..... | 568 |
| SYSTem:SET..... | 568 |
| SYSTem:ERRor[:NEXT]?..... | 568 |
| SYSTem:ERRor:ALL?..... | 568 |
| SYSTem:PRESet..... | 569 |
| SYSTem:EDUCation:PRESet..... | 569 |
| SYSTem:DFPRint?..... | 569 |
| SYSTem:TREE?..... | 569 |

CALibration

Calibration starts the self-alignment process. It can take several minutes. Consider your timeout settings.

Calibration? returns information on the state of the self-alignment. Return values ≠ 0 indicate an error.

Same as *CAL?.

Return values:

<SelfAlignment> Numeric status indicator

CALibration:STATe?

Returns the overall state of the self-alignment.

Return values:

<SelfAlignmentState> NOALignment | RUN | ERRor | OK | ABORt

NOALignment: no self-alignment was performed. Relevant for service operations.

RUN: self-alignment is running

ERRor: an error occurred.

OK: self-alignment has been performed successfully

ABORt: self-alignment has been cancelled

Usage: Query only

SYSTem:NAME

Defines an instrument name.

Parameters:

<Name> String with max. 20 characters

SYSTem:DATE <Year>,<Month>,<Day>

Specifies the internal date for the instrument.

Parameters:

<Year> Increment: 1
 Default unit: a

<Month> Range: 1 to 12
 Increment: 1

<Day> Range: 1 to 31
 Increment: 1
 Default unit: d

Usage: SCPI confirmed

SYSTem:TIME <Hour>,<Minute>,<Second>

Specifies the internal time for the instrument.

Parameters:

<Hour> Range: 0 to 23
 Increment: 1
 Default unit: h

<Minute> Range: 0 to 59
 Increment: 1
 Default unit: min

<Second> Range: 0 to 59
 Increment: 1
 Default unit: s

Usage: SCPI confirmed

SYSTem:COMMunicate:INTERface[:SELEct]

Selects the interface for remote control and web browser access (Ethernet only).

Parameters:

<Interface> USB | Ethernet

SYSTem:BEEPer:CONTRol:STATe

Enables or disables a sound for general control events, e.g. changing the measurement type in the "Measure" menu.

Parameters:

<ControlBeep> ON | OFF

SYSTem:BEEPer:ERRor:STATe

Enables or disables the beep if an error occurs.

Parameters:

<ErrorBeep> ON | OFF

SYSTem:BEEPer:TRIG:STATe

Enables or disables the beep if a trigger occurs.

Parameters:

<TriggerBeep> ON | OFF

SYSTem:BEEPer[:IMMediate]

Generates an immediate beep. You can use this command, for example, to locate the instrument.

Usage: Event

SYSTem:SET <Setup>

Defines or queries the device settings that can be saved and load manually with [File] > "Device Settings".

Parameters:

<Setup> 488.2 block data

Usage: SCPI confirmed

SYSTem:ERRor[:NEXT]?

Returns the oldest item of the error/event queue and removes it from the queue.

Return values:

<Error> Error/event_number,"Error/event_description>[:Device-dependent info]"

Example: 0, "No error"

Usage: Query only
SCPI confirmed

SYSTem:ERRor:ALL?

Returns a list of all error/event numbers and their description, and removes it from the error/event queue.

Return values:

<ErrorList> List of ErrorFormat
List of: Error/event_number,"Error/event_description>[:Device-dependent info]"
If the queue is empty, the response is 0,"No error"

Usage: Query only
SCPI confirmed

SYSTem:PRESet

Resets the instrument to the default state, has the same effect as *RST.

Usage: Event

SYSTem:EDUCation:PRESet

Deletes the password of the education mode.

Usage: Event

SYSTem:DFPRint?

Returns the device footprint of the instrument. The device footprint contains the configuration of the instrument, installed modules, installed software and software licenses. This information is written in the device footprint xml file might be useful in case of maintenance or support request.

Return values:

<DeviceFootprint> Block Data
Information as block data.

Usage: Query only

SYSTem:TREE?

REturns a list of the implemented remote commands.

Return values:

<SystemTree> List of commands

Usage: Query only

16.10.3 LAN Settings

The following commands take effect if `SYSTem:COMMunicate:INTerface[:SElect]` is set to `ETHernet`.

| | |
|--|-----|
| <code>SYSTem:COMMunicate:INTerface:ETHernet:DHCP</code> | 570 |
| <code>SYSTem:COMMunicate:INTerface:ETHernet:IPADdress</code> | 570 |
| <code>SYSTem:COMMunicate:INTerface:ETHernet:SUBNet</code> | 570 |
| <code>SYSTem:COMMunicate:INTerface:ETHernet:GATeway</code> | 570 |
| <code>SYSTem:COMMunicate:INTerface:ETHernet:IPPort</code> | 570 |
| <code>SYSTem:COMMunicate:INTerface:ETHernet:VXIPort</code> | 570 |
| <code>SYSTem:COMMunicate:INTerface:ETHernet:HTTPport</code> | 571 |
| <code>SYSTem:COMMunicate:INTerface:ETHernet:TRANSfer</code> | 571 |
| <code>SYSTem:COMMunicate:INTerface:ETHernet:MACaddress?</code> | 571 |

SYSTem:COMMunicate:INTERface:ETHernet:DHCP

Enables DHCP for automatic network parameter distribution.

Parameters:

<DHCP> ON | OFF

OFF

Use the following commands to specify connection parameters:

[SYSTem:COMMunicate:INTERface:ETHernet:IPADdress](#)
on page 570

[SYSTem:COMMunicate:INTERface:ETHernet:SUBNet](#)
on page 570

[SYSTem:COMMunicate:INTERface:ETHernet:GATeway](#)
on page 570

SYSTem:COMMunicate:INTERface:ETHernet:IPADdress**SYSTem:COMMunicate:INTERface:ETHernet:SUBNet****SYSTem:COMMunicate:INTERface:ETHernet:GATeway**

Return or specify.

- IP address of the instrument.
- IP subnet mask used by the instrument.
- IP gateway used by the instrument.

Parameters:

<FirstByte> Range: 0 to 255
Increment: 1

<SecondByte> Range: 0 to 255
Increment: 1

<ThirdByte> Range: 0 to 255
Increment: 1

<FourthByte> Range: 0 to 255
Increment: 1

SYSTem:COMMunicate:INTERface:ETHernet:IPPort <IPPort>

Returns or specifies the IP port number (default = 5025).

Parameters:

<IPPort> Range: 1024 to 65535

SYSTem:COMMunicate:INTERface:ETHernet:VXIIPort <VXIport>

Specifies the VXI-11 port number.

Parameters:

<VXIport> Range: 0 to 65535
*RST: 1024

SYSTem:COMMunicate:INTerface:ETHernet:HTTPport <HTTPport>

Returns the HTTP port number.

Parameters:

| | | |
|------------|--------|------------|
| <HTTPport> | Range: | 0 to 65535 |
| | *RST: | 80 |

SYSTem:COMMunicate:INTerface:ETHernet:TRANSfer <TransferMode>

Enables automatic transfer speed selection, or selects one of the predefined settings that corresponds to your network data rate.

Parameters:

| | |
|----------------|------------------------------------|
| <TransferMode> | AUTO FD10 FD100 HD10 HD100 |
|----------------|------------------------------------|

AUTO

Automatic transfer speed

FD10 | FD100 | HD10 | HD100

FD = full duplex, HD = half duplex

10 = 10 Mbps, 100 = 100 Mbps

SYSTem:COMMunicate:INTerface:ETHernet:MACaddress?

Returns the instrument's media access control address.

Return values:

| | |
|--------------|------------------|
| <MACaddress> | String data |
| | String parameter |

| | |
|---------------|------------|
| Usage: | Query only |
|---------------|------------|

16.10.4 USB Settings

The following command takes effect if `SYSTem:COMMunicate:INTerface[:SELect]` is set to `USB`.

SYSTem:COMMunicate:INTerface:USB:CLASs

Selects the USB mode.

- USB TMC (Test & Measurement Class)
- USB VCP (Virtual Com Port)
- USB MTP (Media Transfer Protocol)

Parameters:

| | |
|------------|-----------------|
| <USBClass> | TMC VCP MTP |
|------------|-----------------|

16.10.5 Trigger Out

| | |
|---------------------------|-----|
| TRIGger:OUT:MODE..... | 572 |
| TRIGger:OUT:PLENght..... | 572 |
| TRIGger:OUT:POLarity..... | 572 |

TRIGger:OUT:MODE <OutputMode>

Defines which signals are generated at the [Aux Out] connector.

Parameters:

<OutputMode> OFF | TRIGger | REFerence | MASK

OFF

No output

TRIGger

Outputs a pulse when the instrument triggers.

REFerence

Outputs a 10 MHz reference frequency.

MASK

Outputs a pulse when a mask is violated. This function is only available if a mask is specified.

*RST: OFF

TRIGger:OUT:PLENght <PulseLength>

Defines the pulse width of the pulse at the [Aux Out] front connector (at trigger event or mask violation).

Parameters:

<PulseLength> *RST: 1E-6

TRIGger:OUT:POLarity <Polarity>

Defines the polarity of the pulse at the [Aux Out] front connector (at trigger event or mask violation).

Parameters:

<Polarity> POSitive | NEGative

*RST: POS

16.10.6 Firmware Update

| | |
|---------------------------------------|-----|
| DIAGnostic:UPDate:TRANsfer:OPEN..... | 573 |
| DIAGnostic:UPDate:TRANsfer:DATA..... | 573 |
| DIAGnostic:UPDate:TRANsfer:CLOSe..... | 573 |
| DIAGnostic:UPDate:INSTall..... | 573 |

DIAGnostic:UPDate:TRANSfer:OPEN <TransferItem>

Opens a data transfer for the firmware update file, and checks for errors.

Parameters:

<TransferItem> FIRMware

Example: See [Chapter 16.2.2.2, "Using DIAGnostic:UPDate:TRANSfer"](#), on page 409

DIAGnostic:UPDate:TRANSfer:DATA <Offset>,<Checksum>,<Data>

Sends the firmware update file data to the internal RAM of the instrument

Setting parameters:

<Offset> Specifies the byte offset of the blockdata in the file.

<Checksum> CRC-16-CCITT type checksum calculated for the raw binary data in blockdata.

<Data> Block data is composed of a header #nm containing the length of the data followed by the data in raw binary format. Here, m is the length of the data in byte, and n is the number of digits in m.

Example: See [Chapter 16.2.2.2, "Using DIAGnostic:UPDate:TRANSfer"](#), on page 409

Usage: Setting only

DIAGnostic:UPDate:TRANSfer:CLOSe

Closes the file transfer.

Example: See [Chapter 16.2.2.2, "Using DIAGnostic:UPDate:TRANSfer"](#), on page 409.

Usage: Event

DIAGnostic:UPDate:INSTall <Path>

Starts the firmware update.

Setting parameters:

<Path> Empty string

Example: See [Chapter 16.2.2.2, "Using DIAGnostic:UPDate:TRANSfer"](#), on page 409

Usage: Setting only

16.11 Serial Bus Analysis

| | |
|--------------------------------------|-----|
| • General..... | 574 |
| • SPI (Option R&S RTM-K1)..... | 576 |
| • I ² C..... | 589 |
| • UART (Option R&S RTM-K2)..... | 599 |
| • CAN (Option R&S RTM-K3)..... | 608 |
| • LIN (Option R&S RTM-K3)..... | 624 |
| • Audio (Option R&S RTM-K5)..... | 637 |
| • MIL-1553 (Option R&S RTM-K6)..... | 649 |
| • ARINC 429 (Option R&S RTM-K7)..... | 671 |

16.11.1 General

| | |
|-------------------------|-----|
| BUS:TYPE..... | 574 |
| BUS:STATe..... | 574 |
| BUS:FORMat..... | 575 |
| BUS:LABel..... | 575 |
| BUS:LABel:STATe..... | 575 |
| BUS:DSIGNals..... | 575 |
| BUS:DSIZe..... | 575 |
| BUS:POSition..... | 576 |
| BUS:RESult..... | 576 |

BUS:TYPE <Type>

Defines the bus or interface type for analysis. All buses require special option to the instrument.

Suffix:

 1..4

Parameters:

<Type> PARAllel | CPARAllel | I2C | SPI | SSPI | UART | CAN | LIN | I2S | MILStd | ARINc
*RST: PARAllel

BUS:STATe <State>

Switches protocol decoding on or off.

Suffix:

 1..4

Parameters:

<State> ON | OFF
*RST: OFF

BUS:FORMat <Format>

Sets the decoding format for the display on the screen.

Suffix:

 1..4

Parameters:

<Format> ASCII | HEXadecimal | BINary | DECimal | OCTal
*RST: HEX

BUS:LABel <Label>

Defines an additional name label for the selected bus. The maximum name length is 8 characters, and only ASCII characters provided on the on-screen keypad can be used.

Suffix:

 1..2
Selects the bus.

Parameters:

<Label> String value

BUS:LABel:STATe <State>

Displays or hides the bus label. The bus label is shown on the the right side of the display.

Suffix:

 1..2
Selects the bus.

Parameters:

<State> ON | OFF
*RST: ON

BUS:DSIGNals <BitsSignals>

Displays the individual bit lines above the decoded bus line.

Suffix:

 1..4

Parameters:

<BitsSignals> ON | OFF
*RST: ON

BUS:DSIZE <DisplaySize>

Sets the height of the decoded bus signal on the screen.

Suffix:

 1..4

Parameters:

<DisplaySize> SMAL | MEDium | LARGe | DIV2 | DIV4

DIV2 | DIV4

2 or 4 divisions

SMAL | MEDium | LARGe

Size of indicated bus is smaller than 2 div.

*RST: MEDium

BUS:POSition <Position>

Sets the vertical position of the decoded bus signal in divisions on the screen.

Suffix:

 1..4

Parameters:

<Position> Range: 5 to -5

Increment: 0.02

*RST: -3.5

Default unit: DIV

BUS:RESult <ShowResultTable>

Displays or hides the table of decode results.

Suffix:

 1..4

Parameters:

<ShowResultTable> ON | OFF

16.11.2 SPI (Option R&S RTM-K1)

The Serial Peripheral Interface (SPI) is used for communication with slow peripheral devices, in particular, for transmission of data streams.

SPI (no CS) is a Simplified SPI configuration without chip select line.

A 4-channel instrument is required for full support of the SPI (with CS) and SPI (no CS) protocols.

- [SPI \(with CS\)- Configuration](#).....577
- [SPI \(no CS\) - Configuration](#)..... 580
- [SPI - Trigger](#).....583
- [SPI - Decode Results](#).....585

16.11.2.1 SPI (with CS)- Configuration

Start the bus configuration with the threshold setting. Use one of the following commands:

- `CHANnel<m>:THReshold:FINDlevel` on page 422
- `CHANnel<m>:THReshold` on page 421

In all `BUS:SPI...` commands, the suffix `` selects the bus.

| | |
|--|-----|
| <code>BUS:SPI:CS:SOURce</code> | 577 |
| <code>BUS:SPI:CS:POLarity</code> | 577 |
| <code>BUS:SPI:CLOCK:SOURce</code> | 577 |
| <code>BUS:SPI:CLOCK:POLarity</code> | 578 |
| <code>BUS:SPI:DATA:SOURce</code> | 578 |
| <code>BUS:SPI:MOSI:SOURce</code> | 578 |
| <code>BUS:SPI:MISO:SOURce</code> | 578 |
| <code>BUS:SPI:DATA:POLarity</code> | 578 |
| <code>BUS:SPI:MOSI:POLarity</code> | 579 |
| <code>BUS:SPI:MISO:POLarity</code> | 579 |
| <code>BUS:SPI:BORDER</code> | 579 |
| <code>BUS:SPI:SSIZE</code> | 579 |

BUS:SPI:CS:SOURce <Source>

Selects the input channel of the chip select line.

Suffix:

 1..4

Parameters:

<Source> CH1 | CH2 | CH3 | CH4 | D0..D15
*RST: CH1

BUS:SPI:CS:POLarity <Polarity>

Selects whether the chip select signal is high active (high = 1) or low active (low = 1).

Suffix:

 1..4

Parameters:

<Polarity> POSitive | NEGative
POSitive = high active
NEGative = low active
*RST: NEGative

BUS:SPI:CLOCK:SOURce <Source>

Selects the input channel of the clock line.

Suffix:

 1..4

Parameters:<Source> CH1 | CH2 | CH3 | CH4 | D0..D15
*RST: CH1**BUS:SPI:CLOCK:POLarity <Polarity>**

Selects if data is stored with the rising or falling slope of the clock. The slope marks the begin of a new bit.

Suffix:

 1..4

Parameters:<Polarity> POSitive | NEGative
POSitive: rising slope
NEGative: falling slope
*RST: POS**BUS:SPI:DATA:SOURce <Source>****BUS:SPI:MOSI:SOURce <MosiSource>**

Selects the input channel of the MOSI / MISO line.

Suffix:

 1..4

Parameters:<MosiSource> CH1 | CH2 | CH3 | CH4 | D0..D15
*RST: CH1**BUS:SPI:MISO:SOURce <MisoSource>**

Selects the input channel of the optional MISO line.

Suffix:

 1 | 3. Bus 2 or 4 is not available if the MISO source is used on bus 1 or 3, respectively.

Parameters:<MisoSource> CH1 | CH2 | CH3 | CH4 | NONE | D0..D15
*RST: NONE**BUS:SPI:DATA:POLarity <Polarity>**

Selects whether transmitted data is high active (high = 1) or low active (low = 1) on the data line.

Suffix:

 1..4

Parameters:

<Polarity> POSitive | NEGative
 POSitive = high active
 NEGative = low active
 *RST: POSitive

BUS:SPI:MOSI:POLarity <MosiPolarity>

Selects if transmitted data is high active (high = 1) or low active (low = 1) on the MOSI/MISO line.

Suffix:

 1..4

Parameters:

<MosiPolarity> ACTLow | ACTHigh
 *RST: ACTH

BUS:SPI:MISO:POLarity <MisoPolarity>

Selects whether transmitted data is high active (high = 1) or low active (low = 1) on the MISO line.

Suffix:

 1 | 3. Bus 2 or 4 is not available if the MISO source is used on bus 1 or 3, respectively.

Parameters:

<MisoPolarity> ACTLow | ACTHigh
 *RST: ACTH

BUS:SPI:BORDER <BitOrder>

Defines if the data of the messages starts with MSB (most significant bit) or LSB (least significant bit).

Suffix:

 1..4

Parameters:

<BitOrder> MSBFirst | LSBFirst
 *RST: MSBFirst

BUS:SPI:SSIZE <SymbolSize>

Sets the word length, the number of bits in a message.

Suffix:

 1..4

Parameters:

<SymbolSize> Range: 4 to 32
 Increment: 1
 *RST: 8
 Default unit: Bit

16.11.2.2 SPI (no CS) - Configuration

Start the bus configuration with the threshold setting. Use one of the following commands:

- [CHANnel<m>:THReshold:FINDlevel](#) on page 422
- [CHANnel<m>:THReshold](#) on page 421

In all `BUS:SSPI...` commands, the suffix selects the bus.

| | |
|--|-----|
| BUS:SSPI:CLOCK:SOURce | 580 |
| BUS:SSPI:CLOCK:POLarity | 580 |
| BUS:SSPI:DATA:SOURce | 581 |
| BUS:SSPI:MOSI:SOURce | 581 |
| BUS:SSPI:MISO:SOURce | 581 |
| BUS:SSPI:DATA:POLarity | 581 |
| BUS:SSPI:MOSI:POLarity | 581 |
| BUS:SSPI:MISO:POLarity | 582 |
| BUS:SSPI:BITime | 582 |
| BUS:SSPI:BORDER | 582 |
| BUS:SSPI:SSIZE | 582 |

BUS:SSPI:CLOCK:SOURce <Source>

Selects the input channel of the clock line.

Suffix:

 1..4

Parameters:

<Source> CH1 | CH2 | CH3 | CH4 | D0..D15
 CH3 and CH4 are only available with 4-channel R&S RTM3000 oscilloscopes.
 *RST: CH1

BUS:SSPI:CLOCK:POLarity <Polarity>

Selects if data is stored with the rising or falling slope of the clock. The slope marks the begin of a new bit.

Suffix:

 1..4

Parameters:

<Polarity> POSitive | NEGative
 POSitive: rising slope
 NEGative: falling slope
 *RST: POSitive

BUS:SSPI:DATA:SOURce <Source>

BUS:SSPI:MOSI:SOURce <MosiSource>

Selects the input channel of the MOSI / MISO line.

Suffix:

 1..4

Parameters:

<MosiSource> CH1 | CH2 | CH3 | CH4 | D0..D15

*RST: CH1

BUS:SSPI:MISO:SOURce <MisoSource>

Selects the input channel of the optional MISO line.

Suffix:

 1 | 3. Bus 2 or 4 is not available if the MISO source is used on
 bus 1 or 3, respectively.

Parameters:

<MisoSource> CH1 | CH2 | CH3 | CH4 | NONE | D0..D15

*RST: NONE

BUS:SSPI:DATA:POLarity <Polarity>

Selects whether transmitted data is high active (high = 1) or low active (low = 1) on the data line.

Suffix:

 1..4

Parameters:

<Polarity> POSitive | NEGative
 POSitive = high active
 NEGative = low active

*RST: POSitive

BUS:SSPI:MOSI:POLarity <MosiPolarity>

Selects if transmitted data is high active (high = 1) or low active (low = 1) on the MOSI/ MISO line.

Suffix:

 1..4

Parameters:<MosiPolarity> ACTLow | ACTHigh
*RST: ACTH**BUS:SSPI:MISO:POLarity** <MisoPolarity>

Selects whether transmitted data is high active (high = 1) or low active (low = 1) on the MISO line.

Suffix:

 1 | 3. Bus 2 or 4 is not available if the MISO source is used on bus 1 or 3, respectively.

Parameters:<MisoPolarity> ACTLow | ACTHigh
*RST: ACTH**BUS:SSPI:BITime** <BurstIdleTime>

Within the idle time the data and clock lines are low. A new frame begins when the idle time has expired and the clock line has been inactive during that time. If the time interval between the data words is shorter than the idle time, the words are part of the same frame.

Suffix:

 1..4

Parameters:<BurstIdleTime> Range: 16e-9 to 838.832e-6
Increment: 16e-9
*RST: 100e-6
Default unit: s**BUS:SSPI:BORDER** <BitOrder>

Defines if the data of the messages starts with MSB (most significant bit) or LSB (least significant bit).

Suffix:

 1..4

Parameters:<BitOrder> MSBFirst | LSBFirst
*RST: MSBFirst**BUS:SSPI:SSIZe** <SymbolSize>

Sets the word length, the number of bits in a message.

Suffix:

 1..4

Parameters:

<SymbolSize> Range: 4 to 32
 Increment: 1
 *RST: 8
 Default unit: Bit

16.11.2.3 SPI - Trigger

To configure the protocol trigger, make sure to set first:

- `TRIGger:A:TYPE` to BUS
- `TRIGger:A:SOURce` to SBUS1 | SBUS2

| | |
|--|-----|
| <code>TRIGger:A:SOURce:SPI</code> | 583 |
| <code>TRIGger:A:SPI:MODE</code> | 583 |
| <code>TRIGger:A:SPI:PATtern</code> | 584 |
| <code>TRIGger:A:SPI:PLENght</code> | 584 |
| <code>TRIGger:A:SPI:POFFset</code> | 584 |

TRIGger:A:SOURce:SPI <SpiSource>

Selects the MOSI or the MISO line as trigger source. Only relevant, if both lines are used and configured.

Parameters:

<SpiSource> MOSI | MISO

TRIGger:A:SPI:MODE <Mode>

Specifies the trigger mode for the SPI protocols (with and without CS).

Parameters:

<Mode> BStart | BEND | NTHBit | PATtern

BStart

Burst start, sets the trigger event to the start of the frame. The frame starts when the chip select signal CS changes to the active state.

BEND

Burst end, sets the trigger event to the end of the message.

NTHBit

Sets the trigger event to the specified bit number. To define the bit number, use `TRIGger:A:SPI:POFFset`.

PATtern

Sets the trigger event to a serial pattern. To define the pattern, use `TRIGger:A:SPI:PATtern`.

For a complete configuration of the pattern mode, you also have to set `TRIGger:A:SPI:PLENght` and `TRIGger:A:SPI:POFFset`.

*RST: BStart

TRIGger:A:SPI:PATtern <DataPattern>

Defines the bit pattern as trigger condition. The pattern length is adjusted to the number of bits defined in the pattern.

Parameters:

<DataPattern> String with max. 32 characters (4 byte + 8 bit) . Characters 0, 1 and X are allowed.

Example: TRIG:A:SPI:PA TT "0011XXXX0110"
Sets a 12bit pattern.

TRIGger:A:SPI:PLENght <PatternLength>

Returns the number of bits in the previously defined bit pattern (`TRIGger:A:SPI:PATtern`). The command can also be used to shorten a previously defined bit pattern.

Parameters:

<PatternLength> Range: 1 to 32
Increment: 1
*RST: 4

Example: TRIG:A:SPI:PA TT "0011XXXX0110"
TRIG:A:SPI:PLEN?
12
TRIG:A:SPI:PLEN 4
TRIG:A:SPI:PA TT?
"0011"

TRIGger:A:SPI:POFFset <PatternBitOffset>

Sets the number of bits before the first bit of the pattern.

Parameters:

<PatternBitOffset> Number of ignored bits
Range: 0 to 4095
Increment: 1
*RST: 0

16.11.2.4 SPI - Decode Results

In all `BUS:SPI...` and `BUS:SSPI...` commands, the suffix `` selects the bus.

| | |
|---|-----|
| <code>BUS:SPI:FCOut?</code> | 585 |
| <code>BUS:SPI:FRAME<n>:STATus?</code> | 585 |
| <code>BUS:SPI:FRAME<n>:START?</code> | 585 |
| <code>BUS:SPI:FRAME<n>:STOP?</code> | 586 |
| <code>BUS:SPI:FRAME<n>:DATA:MOSI?</code> | 586 |
| <code>BUS:SPI:FRAME<n>:DATA:MISO?</code> | 586 |
| <code>BUS:SPI:FRAME<n>:WCOunt?</code> | 587 |
| <code>BUS:SPI:FRAME<n>:WORD<o>:START?</code> | 587 |
| <code>BUS:SPI:FRAME<n>:WORD<o>:STOP?</code> | 587 |
| <code>BUS:SPI:FRAME<n>:WORD<o>:MOSI?</code> | 588 |
| <code>BUS:SPI:FRAME<n>:WORD<o>:MISO?</code> | 588 |

BUS:SPI:FCOut?

Returns the number of decoded frames.

Suffix:

`` 1..4

Return values:

`<FrameCount>` Total number of decoded frames.

Usage:

Query only

BUS:SPI:FRAME<n>:STATus?

Returns the overall state of the specified frame.

Suffix:

`` 1..4

`<n>`

*

Selects the frame.

Return values:

`<Status>` OK | INCFirst | INCLast | INSufficient

INCFirst

First frame is incomplete

INCLast

Last frame is incomplete

Usage:

Query only

BUS:SPI:FRAME<n>:START?

Returns the start time of the specified frame.

Suffix:

 1..4

<n> *

Return values:

<StartTime> Range: depends on sample rate, record length, and time base
 Increment: depends on the time base
 Default unit: s

Usage: Query only**BUS:SPI:FRAME<n>:STOP?**

Returns the end time of the specified frame.

Suffix:

 1..4

<n> *
Selects the frame.**Return values:**

<StopTime> Range: depends on sample rate, record length, and time base
 Increment: depends on the time base
 Default unit: s

Usage: Query only**BUS:SPI:FRAME<n>:DATA:MOSI?**

Returns the data words of the specified frame of the MOSI line.

Suffix:

 1..4

<n> *
Selects the frame.**Return values:**

<DataMosi> List of decimal values of data bytes

Example:

```
BUS:SPI:FRAM3:DATA:MOSI?
-> 94,177,171,60,242,219,100,0
```

Usage: Query only**BUS:SPI:FRAME<n>:DATA:MISO?**

Returns the data words of the specified frame of the MISO line.

Suffix:

 1..4

<n> *
Selects the frame.

Return values:
<DataMiso> List of decimal values of data bytes

Example: BUS:SPI:FRAM3:DATA:MISO?
-> 94,177,171,60,242,219,100,0

Usage: Query only

BUS:SPI:FRAME<n>:WCOunt?

Returns the number of words in the specified frame.

Suffix:
 1..4
<n> *
Selects the frame.

Return values:
<WordCount> Number of words

Usage: Query only

BUS:SPI:FRAME<n>:WORD<o>:START?

Returns the start time of the specified data word.

Suffix:
 1..4
<n> *
Selects the frame.
<o> *
Selects the word number.

Return values:
<StartTime> Range: depends on sample rate, record length, and time base
Increment: depends on the time base
Default unit: s

Usage: Query only

BUS:SPI:FRAME<n>:WORD<o>:STOP?

Returns the end time of the specified data word.

Suffix:
 1..4

| | | |
|-----------------------|---------------|--|
| <n> | * | Selects the frame. |
| <o> | * | Selects the word number. |
| Return values: | | |
| <StopTime> | Range: | depends on sample rate, record length, and time base |
| | Increment: | depends on the time base |
| | Default unit: | s |
| Usage: | | Query only |

BUS:SPI:FRAME<n>:WORD<o>:MOSI?

Returns the data value of the specified word on the MOSI line.

Use this command if only one line is defined.

Suffix:

| | | |
|-----|------|---------------------------------|
| | 1..4 | |
| <n> | * | Selects the frame (1...n) |
| <o> | * | Selects the word number (1...o) |

Return values:

<Data> Decimal value of the data word

Usage: Query only

BUS:SPI:FRAME<n>:WORD<o>:MISO?

Returns the data value of the specified word on the optional MISO line.

Suffix:

| | | |
|-----|------|---------------------------------|
| | 1..4 | |
| <n> | * | Selects the frame (1...n) |
| <o> | * | Selects the word number (1...o) |

Return values:

<Data> Decimal value of the data word

Usage: Query only

16.11.3 I²C

The Inter-Integrated Circuit is a simple, low-bandwidth, low-speed protocol used for communication between on-board devices, for example, in LCD and LED drivers, RAM, EEPROM, and others.

- I²C - Configuration (Option R&S RTM-K1)..... 589
- I²C - Trigger..... 590
- I²C - Decode Results..... 592

16.11.3.1 I²C - Configuration (Option R&S RTM-K1)

Start the bus configuration with the threshold setting. Use one of the following commands:

- `CHANnel<m>:THReshold:FINDlevel` on page 422
- `CHANnel<m>:THReshold` on page 421

In all `BUS:I2C...` commands, the suffix `` selects the bus.

| | |
|--|-----|
| <code>BUS:I2C:CLOCK:SOURce</code> | 589 |
| <code>BUS:I2C:DATA:SOURce</code> | 589 |

BUS:I2C:CLOCK:SOURce <Source>

Sets the input channel to which the clock line is connected.

Suffix:

 1..4

Parameters:

<Source> CH1 | CH2 | CH3 | CH4 | D0..D15
 CH3 and CH4 are only available with 4-channel R&S RTM3000 oscilloscopes.
 *RST: CH1

BUS:I2C:DATA:SOURce <Source>

Sets the input channel to which the data line is connected.

Suffix:

 1..4

Parameters:

<Source> CH1 | CH2 | CH3 | CH4 | D0..D15
 CH3 and CH4 are only available with 4-channel R&S RTM3000 oscilloscopes.
 *RST: CH1

16.11.3.2 I²C - Trigger

To configure the protocol trigger, make sure to set first:

- `TRIGger:A:TYPE` to BUS
- `TRIGger:A:SOURce` to SBUS1 | SBUS2

| | |
|--|-----|
| <code>TRIGger:A:I2C:MODE</code> | 590 |
| <code>TRIGger:A:I2C:ACCess</code> | 590 |
| <code>TRIGger:A:I2C:AMode</code> | 591 |
| <code>TRIGger:A:I2C:ADDRess</code> | 591 |
| <code>TRIGger:A:I2C:PATtern</code> | 591 |
| <code>TRIGger:A:I2C:PLENght</code> | 592 |
| <code>TRIGger:A:I2C:POFFset</code> | 592 |

`TRIGger:A:I2C:MODE` <Mode>

Specifies the trigger mode for I²C.

Parameters:

<Mode>

START | REStart | STOP | MACKnowledge | PATtern

START

Start of the message. The start condition is a falling slope on SDA while SCL is high.

REStart

Restarted message. The restart is a repeated start condition.

STOP

End of the message. The stop condition is a rising slope on SDA while SCL is high.

MACKnowledge

Missing acknowledge. If the transfer failed, at the moment of the acknowledge bit the SCL and the SDA lines are both on high level.

PATtern

Triggers on a set of trigger conditions: read or write access of the master, to an address, or/and to a bit pattern in the message.

For a complete configuration of the pattern mode, you have to set:

`TRIGger:A:I2C:ACCess` (read/write access), and

`TRIGger:A:I2C:AMode` and `TRIGger:A:I2C:ADDRess` (address), and/or

`TRIGger:A:I2C:POFFset` and `TRIGger:A:I2C:PLENght` and `TRIGger:A:I2C:PATtern` (pattern)

*RST: START

`TRIGger:A:I2C:ACCess` <Access>

Toggles the trigger condition between Read and Write access of the master.

Parameters:

<Access> READ | WRITe
 *RST: READ

TRIGger:A:I2C:AMODe <AdrMode>

Sets the length of the slave address.

Parameters:

<AdrMode> NORMal | EXTended
 NORMal: 7 bit address
 EXTended: 10 bit address
 *RST: NORMal

TRIGger:A:I2C:ADDRess <AddressString>

Sets the address of the slave device. The address can have 7 bits or 10 bits.

Parameters:

<AddressString> String with max. 7 or 10 characters, depending on the address length. Characters 0, 1, and X are allowed, but X cannot be assigned to a specified bit. If at least one X occurs in the address, the complete address is set to X.

Example:

```
TRIG:A:I2C:AMOD NORM
TRIG:A:I2C:ADDR "1011"
TRIG:A:I2C:ADDR?
Return value (7bit address): "0001011"
```

Example:

```
TRIG:A:I2C:AMOD EXT
TRIG:A:I2C:ADDR "10X1"
TRIG:A:I2C:ADDR?
Return value (10bit address): "XXXXXXXXXX"
```

TRIGger:A:I2C:PATTern <DataPattern>

Defines the bit pattern as trigger condition. Make sure that the correct pattern length has been defined before with [TRIGger:A:I2C:PLENght](#).

Parameters:

<DataPattern> String with max. 24 characters (3 byte * 8 bit). Characters 0, 1, and X are allowed. X can be assigned to a specified bit. If you define a pattern shorter than the pattern length, the missing LSB are filled with X. If you define a pattern longer than the pattern length, the pattern string is not valid

Example:

```
TRIG:A:I2C:PLEN 2
TRIG:A:I2C:PATT "10X10000XXXX1111"
TRIG:A:I2C:PATT?
Return value (2 bytes): "10X10000XXXX1111"
```

Example:

```
TRIG:A:I2C:PLEN 1
TRIG:A:I2C:PATT "110"
TRIG:A:I2C:PATT?
Return value (1 byte): "110XXXXX"
```

TRIGger:A:I2C:PLENgtH <PatternLength>

Defines how many bytes are considered in the trigger condition. To set the pattern for these bytes, use [TRIGger:A:I2C:PATtern](#).

Parameters:

<PatternLength> Number of bytes
 Range: 1 to 3
 Increment: 1
 *RST: 1

TRIGger:A:I2C:POFFset <PatternByteOffset>

Sets the number of bytes before the first byte of interest, relating to the end of the address bytes.

Parameters:

<PatternByteOffset> Number of ignored bytes
 Range: 0 to 4095
 Increment: 1
 *RST: 0

16.11.3.3 I²C - Decode Results

In all `BUS:I2C...` commands, the suffix `` selects the bus.

| | |
|---|-----|
| BUS:I2C:FCOut? | 593 |
| BUS:I2C:FRAMe<n>:DATA? | 593 |
| BUS:I2C:FRAMe<n>:STATus? | 593 |
| BUS:I2C:FRAMe<n>:STARt? | 594 |
| BUS:I2C:FRAMe<n>:STOP? | 594 |
| BUS:I2C:FRAMe<n>:AACCess? | 594 |
| BUS:I2C:FRAMe<n>:ACCess? | 594 |
| BUS:I2C:FRAMe<n>:ACOMplete? | 595 |
| BUS:I2C:FRAMe<n>:ADBStart? | 595 |
| BUS:I2C:FRAMe<n>:ADDRess? | 595 |
| BUS:I2C:FRAMe<n>:ADEVice? | 596 |
| BUS:I2C:FRAMe<n>:AMODe? | 596 |
| BUS:I2C:FRAMe<n>:ASTart? | 596 |
| BUS:I2C:FRAMe<n>:BCOut? | 597 |
| BUS:I2C:FRAMe<n>:BYTE<o>:ACCess? | 597 |
| BUS:I2C:FRAMe<n>:BYTE<o>:ACKStart? | 597 |

| | |
|---------------------------------------|-----|
| BUS:I2C:FRAMe<n>:BYTE<o>:COMPLete? | 598 |
| BUS:I2C:FRAMe<n>:BYTE<o>:STARt? | 598 |
| BUS:I2C:FRAMe<n>:BYTE<o>:VALue? | 599 |

BUS:I2C:FCOunt?

Returns the number of received frames.

Suffix:

 1..4

Return values:

<FrameCount> Total number of decoded frames.

Usage: Query only

BUS:I2C:FRAMe<n>:DATA?

Returns the data words of the specified frame.

Suffix:

 1..4

<n> *
Selects the frame.

Return values:

<DataWords> Comma-separated list of decimal values of the data bytes.

Example:

```
BUS:I2C:FRAM2:DATA?
returns four data bytes:
-> 69,158,174,161
```

Usage: Query only

BUS:I2C:FRAMe<n>:STATUs?

Returns the overall state of the frame.

Suffix:

 1..4

<n> *
Selects the frame.

Return values:

<State> INComplete | OK | UNEXpstop | INSufficient | ADDifferent

INComplete

The frame is not completely contained in the acquisition.

Usage: Query only

BUS:I2C:FRAMe<n>:START?

Returns the start time of the specified frame.

Suffix:

| | |
|-----|------|
| | 1..4 |
| <n> | * |

Selects the frame.

Return values:

| | | |
|-------------|---------------|--|
| <StartTime> | Range: | depends on sample rate, record length, and time base |
| | Increment: | depends on the time base |
| | Default unit: | s |

Usage: Query only

BUS:I2C:FRAMe<n>:STOP?

Returns the end time of the specified frame.

Suffix:

| | |
|-----|------|
| | 1..4 |
| <n> | * |

Selects the frame.

Return values:

| | | |
|-----------|---------------|--|
| <EndTime> | Range: | depends on sample rate, record length, and time base |
| | Increment: | depends on the time base |
| | Default unit: | s |

Usage: Query only

BUS:I2C:FRAMe<n>:AACCess?

Returns the address acknowledge bit value for the indicated frame.

Suffix:

| | |
|-----|------|
| | 1..4 |
| <n> | * |

Selects the frame.

Return values:

| | |
|---------------|----------------------------------|
| <Acknowledge> | INComplete ACK NACK EITHER |
|---------------|----------------------------------|

Usage: Query only

BUS:I2C:FRAMe<n>:ACCess?

Returns the transfer direction - read or write access from master to slave.

Suffix:

 1..4
 <n> *
 Selects the frame.

Return values:

<Access> INComplete | READ | WRITE | EITHER | UNDF
INComplete
 The frame is not completely contained in the acquisition.
UNDF
 Access is not defined.

Usage: Query only

BUS:I2C:FRAMe<n>:ACOMplete?

Returns the state of the address.

Suffix:

 1..4
 <n> *
 Selects the frame.

Return values:

<AddressComplete> ON | OFF
ON
 Address was received completely.

Usage: Query only

BUS:I2C:FRAMe<n>:ADBStart?

Returns the start time of the address acknowledge bit.

Suffix:

 1..4
 <n> *
 Selects the frame.

Return values:

<AckStartTime> Range: depends on sample rate, record length, and time base
 Increment: depends on the time base
 Default unit: s

Usage: Query only

BUS:I2C:FRAMe<n>:ADDRess?

Returns the decimal address value of the indicated frame **including** the R/W bit.

Suffix:

 1..4
 <n> *
 Selects the frame.

Return values:

<AddressValue> Decimal value
 Range: 0 to 2047
 Increment: 1

Usage: Query only

BUS:I2C:FRAMe<n>:ADEVice?

Returns the decimal address value of the indicated frame **without** R/W bit.

Suffix:

 1..4
 <n> *
 Selects the frame.

Return values:

<SlaveAddress> Decimal value
 Range: 0 to 1023
 Increment: 1

Usage: Query only

BUS:I2C:FRAMe<n>:AMODE?

Returns the address length.

Suffix:

 1..4
 <n> *
 Selects the frame.

Return values:

<AddressMode> BIT7 | BIT10

Usage: Query only

BUS:I2C:FRAMe<n>:AStart?

Returns the start time of the address for the indicated frame.

Suffix:

 1..4
 <n> *
 Selects the frame.

<0> *
Selects the byte number.

Return values:

<AckStartTime> Range: depends on sample rate, record length, and time base
Increment: depends on the time base
Default unit: s

Usage: Query only

BUS:I2C:FRAMe<n>:BYTE<o>:COMPLete?

Returns the state of the byte.

Suffix:

 1..4

<n> *
Selects the frame.

<o> *
Selects the byte number.

Return values:

<ByteComplete> ON | OFF
ON
Data byte was received completely.

Usage: Query only

BUS:I2C:FRAMe<n>:BYTE<o>:START?

Returns the start time of the specified data byte.

Suffix:

 1..4

<n> *
Selects the frame.

<o> *
Selects the byte number.

Return values:

<StartTime> Range: depends on sample rate, record length, and time base
Increment: depends on the time base
Default unit: s

Usage: Query only

BUS:I2C:FRAMe<n>:BYTE<o>:VALue?

Returns the decimal value of the specified byte.

Suffix:

| | |
|-----|--------------------------|
| | 1..4 |
| <n> | * |
| | Selects the frame. |
| <o> | * |
| | Selects the byte number. |

Return values:

| | |
|-------------|-----------------|
| <ByteValue> | Decimal value |
| | Range: 0 to 255 |
| | Increment: 1 |

Example: BUS:I2C:FRAM2:BYTE2:VAL?
-> 158

Usage: Query only

16.11.4 UART (Option R&S RTM-K2)

The Universal Asynchronous Receiver/Transmitter (UART) converts a word of data into serial data, and vice versa.

- [UART - Configuration](#).....599
- [UART - Trigger](#).....602
- [UART - Decode Results](#).....604

16.11.4.1 UART - Configuration

Start the bus configuration with the threshold setting. Use one of the following commands:

- [CHANnel<m>:THReshold:FINDlevel](#) on page 422
- [CHANnel<m>:THReshold](#) on page 421

In all `BUS:UART...` commands, the suffix `` selects the bus.

| | |
|---|-----|
| BUS:UART:RX:SOURce | 600 |
| BUS:UART:DATA:SOURce | 600 |
| BUS:UART:TX:SOURce | 600 |
| BUS:UART:POLarity | 600 |
| BUS:UART:DATA:POLarity | 600 |
| BUS:UART:SSIZE | 601 |
| BUS:UART:PARity | 601 |
| BUS:UART:SBIT | 601 |
| BUS:UART:BAUDrate | 601 |
| BUS:UART:BITime | 602 |

BUS:UART:RX:SOURce <Source>

BUS:UART:DATA:SOURce <Source>

Selects the input channel of the data line.

Suffix:

 1..4

Parameters:

<Source> CH1 | CH2 | CH3 | CH4 | D0..D15

CH3 and CH4 are only available with 4-channel R&S RTM3000 oscilloscopes.

*RST: CH1

BUS:UART:TX:SOURce <Source>

Selects the input channel of the transmitter TX line.

Suffix:

 1 | 3. Bus 2 or 4 is not available if the TX source is used on bus 1 or 3, respectively.

Parameters:

<TxSource> CH1 | CH2 | CH3 | CH4 | NONE | D0..D15

NONE

Disables the optional TX line.

*RST: NONE

BUS:UART:POLarity <IdleState>

Defines the logic levels of the bus. The idle state corresponds to a logic 1, and the start bit to a logic 0.

Alternative command for [BUS:UART:DATA:POLarity](#)

Suffix:

 1..4

Parameters:

<IdleState> IDLLow | IDLHigh

IDLLow: idle low, low = 1

IDLHigh: idle high, high = 1

*RST: IDLH

BUS:UART:DATA:POLarity <Polarity>

Defines if the transmitted data on the bus is high (high = 1) or low (low = 1) active.

Alternative command for [BUS:UART:POLarity](#).

Suffix:

 1..4

Parameters:

<Polarity> POSitive | NEGative
 POSitive = high active
 NEGative = low active
 *RST: POS

BUS:UART:SSIZE <SymbolSize>

Sets the number of data bits in a message.

Suffix:

 1..4

Parameters:

<SymbolSize> Range: 5 to 9
 Increment: 1
 *RST: 8
 Default unit: Bit

BUS:UART:PARity <Parity>

Defines the optional parity bit that is used for error detection.

Suffix:

 1..2
 Selects the bus.
 Note: SPI and UART protocols occupy two bus lines.

Parameters:

<Parity> ODD | EVEN | NONE
 *RST: NONE

BUS:UART:SBIT <StopBitNumber>

Sets the stop bits.

Suffix:

 1..2
 Selects the bus.
 Note: SPI and UART protocols occupy two bus lines.

Parameters:

<StopBitNumber> B1 | B1_5 | B2
 1 stop bit, 1.5 stop bits or 2 stop bits are possible.
 *RST: B1

BUS:UART:BAUDrate <Baudrate>

Sets the number of transmitted bits per second.

Suffix:

 1..4

Parameters:

<Baudrate> Range: 100 to 78.1E6
 Increment: 100
 *RST: 115200
 Default unit: Bit

BUS:UART:BITime <BurstIdleTime>

Sets the minimal time between two data frames (packets), that is, between the last stop bit and the start bit of the next frame.

Suffix:

 1..4

Parameters:

<BurstIdleTime> Range: Range depends on the bus configuration, mainly on bit rate and symbol size.
 Default unit: s

16.11.4.2 UART - Trigger

To configure the protocol trigger, make sure to set first:

- `TRIGger:A:TYPE` to BUS
- `TRIGger:A:SOURce` to SBUS1 | SBUS2

| | |
|---|-----|
| <code>TRIGger:A:SOURce:UART</code> | 602 |
| <code>TRIGger:A:UART:MODE</code> | 602 |
| <code>TRIGger:A:UART:PATtern</code> | 603 |
| <code>TRIGger:A:UART:PLENght</code> | 603 |
| <code>TRIGger:A:UART:POFFset</code> | 603 |

TRIGger:A:SOURce:UART <UartSource>

Selects the transmitter or receiver line as trigger source.

Parameters:

<UartSource> RX | TX

TRIGger:A:UART:MODE <Mode>

Specifies the trigger mode for UART/RS-232 interfaces.

See also: "[UART trigger settings](#)" on page 262.

Parameters:

<Mode> BStart | SBIT | NTHSymbol | SYMBol | PATtern | PRERror | SPERror | BREak

BStart

Burst start. Sets the trigger to the begin of a data frame. The frame start is the first start bit after the idle time.

SBIT

Start bit. The start bit is the first low bit after a stop bit.

NTHSymbol

Sets the trigger to the n-th symbol of a burst.

SYMBOL

Triggers if a pattern occurs in a symbol at any position in a burst.

PATtern

Triggers on a serial pattern at a defined position in the burst.

To define the pattern, use `TRIGger:A:UART:PLENgtH` and `TRIGger:A:UART:PATtern`.

To define the position, use `TRIGger:A:UART:POFFset`.

PRERror

Parity Error: Triggers if a bit error occurred in transmission.

FERRor

Triggers on frame error.

BREak

Triggers if a start bit is not followed by a stop bit within a defined time. During the break the stop bits are at low state.

*RST: SBIT

TRIGger:A:UART:PATtern <DataPattern>

Defines the bit pattern as trigger condition.

Parameters:

<DataPattern> Binary pattern with max. 32 bit. Characters 0, 1, and X are allowed.

*RST: 1 = "00000001"

TRIGger:A:UART:PLENgtH <PatternLength>

Defines how many symbols build up the serial pattern.

Parameters:

<PatternLength> Number of symbols

Range: 1 to 4

Increment: 1

*RST: 1

TRIGger:A:UART:POFFset <PatternByteOffset>

Sets the number of symbols before the first symbol of the pattern.

Parameters:

<PatternByteOffset> Number of ignored symbols
 Range: 0 to 4095
 Increment: 1
 *RST: 0

16.11.4.3 UART - Decode Results

In all `BUS:UART...` commands, the suffix `` selects the bus.

| | |
|---|-----|
| <code>BUS:UART:FCOut?</code> | 604 |
| <code>BUS:UART:RX:FCOut?</code> | 604 |
| <code>BUS:UART:TX:FCOut?</code> | 604 |
| <code>BUS:UART:FRAMe<n>:STARt?</code> | 605 |
| <code>BUS:UART:RX:FRAMe<n>:STARt?</code> | 605 |
| <code>BUS:UART:TX:FRAMe<n>:STARt?</code> | 605 |
| <code>BUS:UART:FRAMe<n>:STOP?</code> | 605 |
| <code>BUS:UART:RX:FRAMe<n>:STOP?</code> | 605 |
| <code>BUS:UART:TX:FRAMe<n>:STOP?</code> | 605 |
| <code>BUS:UART:FRAMe<n>:STATe?</code> | 605 |
| <code>BUS:UART:RX:FRAMe<n>:STATe?</code> | 605 |
| <code>BUS:UART:TX:FRAMe<n>:STATe?</code> | 605 |
| <code>BUS:UART:FRAMe<n>:WCOunt?</code> | 606 |
| <code>BUS:UART:RX:FRAMe<n>:WCOunt?</code> | 606 |
| <code>BUS:UART:TX:FRAMe<n>:WCOunt?</code> | 606 |
| <code>BUS:UART:FRAMe<n>:WORD<o>:SOURce?</code> | 606 |
| <code>BUS:UART:FRAMe<n>:WORD<o>:STATe?</code> | 606 |
| <code>BUS:UART:RX:FRAMe<n>:WORD<o>:STATe?</code> | 606 |
| <code>BUS:UART:TX:FRAMe<n>:WORD<o>:STATe?</code> | 606 |
| <code>BUS:UART:FRAMe<n>:WORD<o>:STARt?</code> | 607 |
| <code>BUS:UART:RX:FRAMe<n>:WORD<o>:STARt?</code> | 607 |
| <code>BUS:UART:TX:FRAMe<n>:WORD<o>:STARt?</code> | 607 |
| <code>BUS:UART:FRAMe<n>:WORD<o>:STOP?</code> | 608 |
| <code>BUS:UART:RX:FRAMe<n>:WORD<o>:STOP?</code> | 608 |
| <code>BUS:UART:TX:FRAMe<n>:WORD<o>:STOP?</code> | 608 |
| <code>BUS:UART:FRAMe<n>:WORD<o>:VALue?</code> | 608 |
| <code>BUS:UART:FRAMe<n>:WORD<o>:RXValue?</code> | 608 |
| <code>BUS:UART:FRAMe<n>:WORD<o>:TXValue?</code> | 608 |
| <code>BUS:UART:RX:FRAMe<n>:WORD<o>:VALue?</code> | 608 |
| <code>BUS:UART:TX:FRAMe<n>:WORD<o>:VALue?</code> | 608 |

`BUS:UART:FCOut?`

`BUS:UART:RX:FCOut?`

`BUS:UART:TX:FCOut?`

Return the number of decoded frames on the indicated line, respectively.

Suffix:

 1..4

Return values:

<FrameCount> Total number of decoded frames.

Usage: Query only

BUS:UART:FRAME<n>:START?

BUS:UART:RX:FRAME<n>:START?

BUS:UART:TX:FRAME<n>:START?

Return the start time of the specified frame.

Suffix:

 1..4

<n> *
Selects the frame.

Return values:

<TxFrameStart> Time in s, range depends on sample rate, record length, and time base

Usage: Query only

BUS:UART:FRAME<n>:STOP?

BUS:UART:RX:FRAME<n>:STOP?

BUS:UART:TX:FRAME<n>:STOP?

Return the end time of the specified frame.

Suffix:

 1..4

<n> *
Selects the frame.

Return values:

<TxFrameStop> Time in s, range depends on sample rate, record length, and time base

Usage: Query only

BUS:UART:FRAME<n>:STATE?

BUS:UART:RX:FRAME<n>:STATE?

BUS:UART:TX:FRAME<n>:STATE?

Returns the status of the specified frame.

Suffix:

 1..4

<n> *
Selects the frame.

Return values:

<TxFrameState> STER | SPER | PRER | BRE | OK | INS

STER: start error, no start bit found.
 SPERr: stop error, no stop condition found.
 PRER: parity error, which indicates a transmission error.
 BRE: break condition found. A start bit is not followed by a stop bit, and the data line remains at logic 0 for longer than a UART word.
 OK: the frame is valid.
 INS: the frame is not completely contained in the acquisition. The acquired part of the frame is valid.

Usage: Query only

BUS:UART:FRAME<n>:WCOunt?
BUS:UART:RX:FRAME<n>:WCOunt?
BUS:UART:TX:FRAME<n>:WCOunt?

Returns the number of symbols in the specified frame.

Suffix:

| | |
|-----|------|
| | 1..4 |
| <n> | * |

Selects the frame.

Return values:

| | |
|-------------|---------------------------------------|
| <WordCount> | Number of words (symbols, characters) |
|-------------|---------------------------------------|

Usage: Query only

BUS:UART:FRAME<n>:WORD<o>:SOURce?

Returns the line on which the specified word was transferred.

Suffix:

| | |
|-----|------|
| | 1..4 |
| <n> | * |

Selects the frame.

| | |
|-----|---|
| <o> | * |
|-----|---|

Selects the word.

Return values:

| | |
|----------|----------|
| <Source> | TX or RX |
|----------|----------|

Usage: Query only

BUS:UART:FRAME<n>:WORD<o>:STATe?
BUS:UART:RX:FRAME<n>:WORD<o>:STATe?
BUS:UART:TX:FRAME<n>:WORD<o>:STATe?

Returns the status of the specified symbol (word).

Suffix:

| | |
|-----|--------------------------|
| | 1..4 |
| <n> | * |
| | Selects the frame. |
| <o> | * |
| | Selects the word number. |

Return values:

| | |
|----------|--|
| <Status> | OK FRStArT FREnd FRMErroR STERror SPERror PRERror INSufficient BREak |
| | OK: the frame is valid. |
| | FRStArT: frame start not found |
| | FREnd: frame end not found |
| | FRMErroR: error in frame |
| | STERror: start error, no start bit found. |
| | SPERror: stop error, no stop condition found. |
| | PRERror: parity error, which indicates a transmission error. |
| | INSufficient: the frame is not completely contained in the acquisition. The acquired part of the frame is valid. |
| | BREak: break condition found. A start bit is not followed by a stop bit, and the data line remains at logic 0 for longer than a UART word. |

Usage: Query only

BUS:UART:FRAME<n>:WORD<o>:START?
BUS:UART:RX:FRAME<n>:WORD<o>:START?
BUS:UART:TX:FRAME<n>:WORD<o>:START?

Returns the start time of the specified symbol (word).

Suffix:

| | |
|-----|--------------------------|
| | 1..4 |
| <n> | * |
| | Selects the frame. |
| <o> | * |
| | Selects the word number. |

Return values:

| | |
|-------------|---|
| <StartTime> | Range: depends on sample rate, record length, and time base |
| | Increment: depends on the time base |
| | Default unit: s |

Usage: Query only

BUS:UART:FRAMe<n>:WORD<o>:STOP?
BUS:UART:RX:FRAMe<n>:WORD<o>:STOP?
BUS:UART:TX:FRAMe<n>:WORD<o>:STOP?

Returns the end time of the specified symbol (word).

Suffix:

| | |
|-----|--------------------------|
| | 1..4 |
| <n> | * |
| | Selects the frame. |
| <o> | * |
| | Selects the word number. |

Return values:

| | | |
|------------|---------------|--|
| <StopTime> | Range: | depends on sample rate, record length, and time base |
| | Increment: | depends on the time base |
| | Default unit: | s |

Usage: Query only

BUS:UART:FRAMe<n>:WORD<o>:VALue?
BUS:UART:FRAMe<n>:WORD<o>:RXValue?
BUS:UART:FRAMe<n>:WORD<o>:TXValue?
BUS:UART:RX:FRAMe<n>:WORD<o>:VALue?
BUS:UART:TX:FRAMe<n>:WORD<o>:VALue?

Return the value of the specified symbol (word) on the Rx line and Tx line, respectively.

Suffix:

| | |
|-----|--------------------------|
| | 1..4 |
| <n> | * |
| | Selects the frame. |
| <o> | * |
| | Selects the word number. |

Return values:

| | | |
|---------|------------|----------|
| <Value> | Range: | 0 to 511 |
| | Increment: | 1 |

Usage: Query only

16.11.5 CAN (Option R&S RTM-K3)

CAN is the Controller Area Network, a bus system used within automotive network architecture.

| | |
|-----------------------------|-----|
| • CAN - Configuration..... | 609 |
| • CAN - Trigger..... | 610 |
| • CAN - Decode Results..... | 614 |
| • CAN - Search..... | 620 |

16.11.5.1 CAN - Configuration

Start the bus configuration with the threshold setting. Use one of the following commands:

- `CHANnel<m>:THReshold:FINDlevel` on page 422
- `CHANnel<m>:THReshold` on page 421

In all `BUS:CAN...` commands, the suffix `` selects the bus.

| | |
|---|-----|
| <code>BUS:CAN:DATA:SOURce</code> | 609 |
| <code>BUS:CAN:TYPE</code> | 609 |
| <code>BUS:CAN:SAMPlepoint</code> | 610 |
| <code>BUS:CAN:BITRate</code> | 610 |

BUS:CAN:DATA:SOURce <Source>

Sets the source of the data line. All channel waveforms can be used.

Suffix:

 1..4

Parameters:

<Source> CH1 | CH2 | CH3 | CH4 | D0..D15

Logic channels D0..D15 are available if MSO option R&S RTM-B1 is installed.

*RST: CH1

BUS:CAN:TYPE <SignalType>

Selects the CAN-High or CAN-Low line. CAN uses both lines for differential signal transmission.

If you measure with a differential probe, connect the probe to both CAN-H and CAN-L lines, and set the type CANH.

If you use a single-ended probe, connect the probe to either CAN_L or CAN_H, and select the type accordingly.

Suffix:

 1..4

Parameters:

<SignalType> CANH | CANL

*RST: CANH

BUS:CAN:SAMPlEpoint <SamplePoint>

Sets the position of the sample point within the bit in percent of the nominal bit time.

See also: "[Sample Point](#)" on page 268.

Suffix:

 1..4

Parameters:

<SamplePoint> Range: 10 to 90
Increment: 1
*RST: 50
Default unit: %

BUS:CAN:BITRate <BitRate>

Sets the number of transmitted bits per second.

Suffix:

 1..4

Parameters:

<BitRate> Range: 100 to 5,04E06
Increment: Depends on the bit rate value
*RST: 50E03
Default unit: Bit/s

16.11.5.2 CAN - Trigger

To configure the protocol trigger, make sure to set first:

- `TRIGger:A:TYPE` to BUS
- `TRIGger:A:SOURce` to SBUS1 | SBUS2

| | |
|---|-----|
| <code>TRIGger:A:CAN:TYPE</code> | 611 |
| <code>TRIGger:A:CAN:FTYPE</code> | 611 |
| <code>TRIGger:A:CAN:ITYPE</code> | 611 |
| <code>TRIGger:A:CAN:ICONdition</code> | 612 |
| <code>TRIGger:A:CAN:IDENtifier</code> | 612 |
| <code>TRIGger:A:CAN:DCONdition</code> | 612 |
| <code>TRIGger:A:CAN:DLC</code> | 612 |
| <code>TRIGger:A:CAN:DATA</code> | 613 |
| <code>TRIGger:A:CAN:ACKerror</code> | 613 |
| <code>TRIGger:A:CAN:BITSterror</code> | 613 |
| <code>TRIGger:A:CAN:CRCError</code> | 613 |
| <code>TRIGger:A:CAN:FORMerror</code> | 614 |

TRIGger:A:CAN:TYPE <TriggerType>

Specifies the trigger mode for CAN.

Parameters:

<TriggerType> STOframe | EOFframe | ID | IDDT | FTYPe | ERRCondition

STOframe

Start of frame

EOFframe

End of frame

ID

Sets the trigger to a specific message "Identifier" or an "Identifier" range.

Specify the identifier with [TRIGger:A:CAN:ITYPe](#), [TRIGger:A:CAN:ICONdition](#) and [TRIGger:A:CAN:IDENTifier](#).

IDDT

Sets the trigger to a combination of "Identifier and Data" condition. The instrument triggers at the end of the last byte of the specified data pattern.

Specify the "Identifier" (see [ID](#)), and the "Data" with [TRIGger:A:CAN:DLC](#), [TRIGger:A:CAN:DCONDITION](#) and [TRIGger:A:CAN:DATA](#).

FTYPe

Triggers on a specified "Frame".

Specify the frame type with [TRIGger:A:CAN:FTYPe](#).

ERRCondition

Identifies various errors in the frame.

Specify the "Error" with [TRIGger:A:CAN:ACKerror](#), [TRIGger:A:CAN:BITSterror](#), [TRIGger:A:CAN:CRCError](#) and [TRIGger:A:CAN:FORMerror](#).

*RST: STOF

TRIGger:A:CAN:FTYPe <FrameType>

Specifies the frame type to be triggered on if [TRIGger:A:CAN:TYPE](#) is set to [FTYPe](#).

Parameters:

<FrameType> DATA | REMote | ERRor | OVERload | ANY

*RST: ERR

TRIGger:A:CAN:ITYPe <IdentifierType>

Selects the length of the identifier: 11 bit for CAN base frames, or 29 bits for CAN extended frames.

The command is relevant if [TRIGger:A:CAN:TYPE](#) is set to [ID](#), [IDDT](#), or [FTYPe](#) (data and remote frames).

Parameters:

<IdentifierType> B11 | B29 | ANY

ANY: use if the identifier length is not relevant. Not available for trigger type ID.

*RST: B11

TRIGger:A:CAN:ICONdition <IdentifierCondition>

Sets the comparison condition: If the pattern contains at least one X (don't care), you can trigger on values equal or not equal to the specified value. If the pattern contains only 0 and 1, you can also trigger on a range greater than or lower than the specified value.

The command is relevant, if `TRIGger:A:CAN:TYPE` is set to ID or IDDT.

Parameters:

<IdentifierCondition> EQUual | NEQual | GTHan | LTHan

*RST: EQ

TRIGger:A:CAN:IDENTifier <Identifier>

Defines the identifier pattern. The pattern length is defined with `TRIGger:A:CAN:ITYPE`.

The command is relevant if `TRIGger:A:CAN:TYPE` is set to ID or IDDT.

Parameters:

<Identifier> String containing binary pattern with 11 bit or 29 bit. Characters 0, 1, and X are allowed.

TRIGger:A:CAN:DCONdition <DataCondition>

Sets the comparison condition for data: If the pattern contains at least one X (don't care), you can trigger on values equal or not equal to the specified value. If the pattern contains only 0 and 1, you can also trigger on a range greater than or lower than the specified value.

The command is relevant if `TRIGger:A:CAN:TYPE` is set to IDDT.

Parameters:

<DataCondition> EQUal | NEQual | GTHan | LTHan

*RST: EQ

TRIGger:A:CAN:DLC <DataLength>

Defines the length of the data pattern - the number of bytes in the pattern.

The command is relevant if `TRIGger:A:CAN:TYPE` is set to IDDT.

Parameters:

<DataLength> Range: 0 to 8
 Increment: 1
 *RST: 1
 Default unit: Byte

TRIGger:A:CAN:DATA <Data>

Defines the data pattern. The number of bytes in the data pattern is defined with [TRIGger:A:CAN:DLC](#).

The command is relevant if [TRIGger:A:CAN:TYPE](#) is set to IDDT.

Parameters:

<Data> String containing binary pattern with max. 64 bit. Characters 0, 1, and X are allowed. Make sure to enter complete bytes.

TRIGger:A:CAN:ACKerror <AcknowledgeError>

Triggers on acknowledgement errors. An acknowledgement error occurs when the transmitter does not receive an acknowledgment - a dominant bit during the Ack Slot.

The command is relevant if [TRIGger:A:CAN:TYPE](#) is set to ERRCondition.

Parameters:

<AcknowledgeError> ON | OFF
 *RST: OFF

TRIGger:A:CAN:BITSterror <BitStuffingError>

Triggers on bit stuffing errors.

See also: "[Stuff Bit](#)" on page 271.

The command is relevant if [TRIGger:A:CAN:TYPE](#) is set to ERRCondition.

Parameters:

<BitStuffingError> ON | OFF
 *RST: ON

TRIGger:A:CAN:CRCErrror <CRCErrror>

Triggers on errors in the Cyclic Redundancy Check.

The command is relevant if [TRIGger:A:CAN:TYPE](#) is set to ERRCondition.

Parameters:

<CRCErrror> ON | OFF
 *RST: OFF

TRIGger:A:CAN:FORMerror <FormError>

Triggers on form errors. A form error occurs when a fixed-form bit field contains one or more illegal bits.

The command is relevant if **TRIGger:A:CAN:TYPE** is set to **ERRCondition**.

Parameters:

<FormError> ON | OFF
 *RST: OFF

16.11.5.3 CAN - Decode Results

In all **BUS:CAN...** commands, the suffix **** selects the bus.

| | |
|---|-----|
| BUS:CAN:FCOunt? | 614 |
| BUS:CAN:FRAME<n>:TYPE? | 614 |
| BUS:CAN:FRAME<n>:STATus? | 615 |
| BUS:CAN:FRAME<n>:START? | 615 |
| BUS:CAN:FRAME<n>:STOP? | 616 |
| BUS:CAN:FRAME<n>:DATA? | 616 |
| BUS:CAN:FRAME<n>:ACKState? | 616 |
| BUS:CAN:FRAME<n>:ACKValue? | 616 |
| BUS:CAN:FRAME<n>:CSState? | 617 |
| BUS:CAN:FRAME<n>:CSValue? | 617 |
| BUS:CAN:FRAME<n>:DLCState? | 617 |
| BUS:CAN:FRAME<n>:DLCValue? | 618 |
| BUS:CAN:FRAME<n>:IDState? | 618 |
| BUS:CAN:FRAME<n>:IDType? | 618 |
| BUS:CAN:FRAME<n>:IDValue? | 618 |
| BUS:CAN:FRAME<n>:BSEPosition? | 619 |
| BUS:CAN:FRAME<n>:BCOunt? | 619 |
| BUS:CAN:FRAME<n>:BYTE<o>:STATE? | 619 |
| BUS:CAN:FRAME<n>:BYTE<o>:VALue? | 620 |

BUS:CAN:FCOunt?

Returns the number of received frames.

Suffix:

 1..4

Return values:

<FrameCount> Total number of decoded frames.

Usage:

Query only

BUS:CAN:FRAME<n>:TYPE?

Returns the type of the specified frame.

Suffix:

 1..4

<n> *

Selects the frame (1...n).

Return values:

<FrameType> DATA | REMote | ERR | OVLD

Data, remote, error or overload frame

Usage:

Query only

BUS:CAN:FRAME<n>:STATus?

Returns the overall state of the specified frame.

Suffix:

 1..4

<n> *

Selects the frame (1...n).

Return values:<FrameStatus> OK | BTST | CRCD | ACKD | CRC | EOFD | NOACK |
INSufficient

OK: frame is valid.

BTST: bit stuffing error occurred

CRCD: wrong CRC delimiter occurred

ACKD: Wrong ACK delimiter occurred

CRC: cyclic redundancy check failed

EOfD: wrong end of frame

NOACK: acknowledge is missing

INSufficient: frame is not completely contained in the acquisition.

The acquired part of the frame is valid.

Usage:

Query only

BUS:CAN:FRAME<n>:START?

Returns the start time of the specified frame.

Suffix:

 1..4

<n> *

Selects the frame (1...n).

Return values:

<StartTime> Default unit: s

Usage:

Query only

BUS:CAN:FRAME<n>:STOP?

Returns the end time of the specified frame.

Suffix:

 1..4

<n> *

Selects the frame (1...n).

Return values:

<StopTime> Default unit: s

Usage: Query only

BUS:CAN:FRAME<n>:DATA?

Returns the data words of the specified frame.

Suffix:

 1..4

<n> *

Selects the frame (1...n).

Return values:

<FrameData> Comma-separated list of decimal values of the data bytes.

Usage: Query only

BUS:CAN:FRAME<n>:ACKState?

Returns the state of the acknowledge field.

Suffix:

 1..4

<n> *

Selects the frame (1...n).

Return values:

<AcknowledgeState> OK | UNDF
UNDF: Undefined

Usage: Query only

BUS:CAN:FRAME<n>:ACKValue?

Returns the value of the acknowledge field.

Suffix:

 1..4

<n> *

Selects the frame (1...n).

Return values:

<AcknowledgeValue> Decimal value

Usage: Query only

BUS:CAN:FRAME<n>:CSState?

Returns the state of the checksum.

Suffix:

 1..4

<n> *

Selects the frame (1...n).

Return values:

<ChecksumState> OK | UNDF

UNDF: Undefined

Usage: Query only

BUS:CAN:FRAME<n>:CSValue?

Returns the checksum value.

Suffix:

 1..4

<n> *

Selects the frame (1...n).

Return values:

<ChecksumValue> Decimal value

Usage: Query only

BUS:CAN:FRAME<n>:DLCState?

Returns the state of the data length code.

Suffix:

 1..4

<n> *

Selects the frame (1...n).

Return values:

<DLCState> OK | UNDF

UNDF: Undefined

Usage: Query only

BUS:CAN:FRAME<n>:DLCValue?

Returns the number of data bytes in the specified frame.

Suffix:

 1..4

<n> *

Selects the frame (1...n).

Return values:

<DLCValue> Non-negative integer

Usage: Query only

BUS:CAN:FRAME<n>:IDState?

Returns the state of the identifier.

Suffix:

 1..4

<n> *

Selects the frame (1...n).

Return values:

<IdentifierState> OK | UNDF

UNDF: Undefined

Usage: Query only

BUS:CAN:FRAME<n>:IDType?

Returns the length of the identifier: 11 bits for CAN base frames, 29 bits for CAN extended frames.

Suffix:

 1..4

<n> *

Selects the frame (1...n).

Return values:

<IdentifierType> ANY | B11 | B29

Usage: Query only

BUS:CAN:FRAME<n>:IDValue?

Returns the identifier of the specified frame.

Suffix:

 1..4

<n> *
Selects the frame (1...n).

Return values:

<IdentifierValue> Decimal value

Usage: Query only

BUS:CAN:FRAME<n>:BSEPosition?

Returns the position of the bit stuffing error in the specified frame (if available).

Suffix:

 1..4

<n> *
Selects the frame (1...n).

Return values:

<ErrorPosition> *RST: 0
Default unit: s

Usage: Query only

BUS:CAN:FRAME<n>:BCOunt?

Returns the number of data bytes in the specified frame.

Suffix:

 1..4

<n> *
Selects the frame (1...n).

Return values:

<ByteCount> Number of words (bytes)

Usage: Query only

BUS:CAN:FRAME<n>:BYTE<o>:STATE?

Returns the state of the specified data byte.

Suffix:

 1..4

<n> *
Selects the frame (1...n).

<o> *
Selects the byte number (1...m).

Return values:

<ByteStatus> OK | UNDF
UNDF: Undefined

Usage: Query only

BUS:CAN:FRAME<n>:BYTE<o>:VALue?

Returns the decimal value of the specified byte.

Suffix:

| | |
|-----|----------------------------------|
| | 1..4 |
| <n> | * |
| | Selects the frame (1...n). |
| <o> | * |
| | Selects the byte number (1...m). |

Return values:

<ByteValue> Decimal value

Usage: Query only

16.11.5.4 CAN - Search

| | |
|-------------------------------------|-----|
| SEARch:PROTocol:CAN:CONDition..... | 620 |
| SEARch:PROTocol:CAN:FRAMe..... | 621 |
| SEARch:PROTocol:CAN:ACKerror..... | 621 |
| SEARch:PROTocol:CAN:BITSterror..... | 622 |
| SEARch:PROTocol:CAN:CRError..... | 622 |
| SEARch:PROTocol:CAN:FORMerror..... | 622 |
| SEARch:PROTocol:CAN:FTYPE..... | 622 |
| SEARch:PROTocol:CAN:ITYPe..... | 622 |
| SEARch:PROTocol:CAN:ICONdition..... | 623 |
| SEARch:PROTocol:CAN:IDENtifier..... | 623 |
| SEARch:PROTocol:CAN:DLENgth..... | 623 |
| SEARch:PROTocol:CAN:DCONdition..... | 623 |
| SEARch:PROTocol:CAN:DATA..... | 624 |

SEARch:PROTocol:CAN:CONDition <SearchCondition>

Sets the event or combination of events to be searched for. Depending on the selected event, further settings are required.

Parameters:

<SearchCondition> FRAME | ERRor | IDENtifier | IDData | IDERror

FRAME

Search for a frame type. Set the frame type with [SEARch:PROTocol:CAN:FRAMe](#).

ERRor

Search for errors of one or more error types. Set the error types with [SEARch:PROTocol:CAN:ACKerror](#), [SEARch:PROTocol:CAN:BITSterror](#), [SEARch:PROTocol:CAN:CRError](#) and [SEARch:PROTocol:CAN:FORMerror](#).

IDENTifier

Search for identifier.

Specify the identifier with `SEARCH:PROTOCOL:CAN:FTYPE`, `SEARCH:PROTOCOL:CAN:ITYPE`, `SEARCH:PROTOCOL:CAN:ICONDITION` and `SEARCH:PROTOCOL:CAN:IDENTIFIER`.

IDData

Search for identifier and data.

Set the identifier (see `IDENTifier`) and the data with `SEARCH:PROTOCOL:CAN:DLENGTH`, `SEARCH:PROTOCOL:CAN:DCONDITION` and `SEARCH:PROTOCOL:CAN:DATA`.

IDERror

Search for errors that occur with a specified identifier.

Set the identifier (see `IDENTifier`) and the errors to be found (see `ERRor`)

*RST: FRAM

SEARCH:PROTOCOL:CAN:FRAME <Frame>

Selects the frame type to be searched for.

The command is relevant if `SEARCH:PROTOCOL:CAN:CONDITION` is set to `FRAME`.

Parameters:

<Frame> SOF | EOF | OVERload | ERRor | DTA11 | DTA29 | REM11 | REM29

SOF: start of frame

EOF: end of frame

OVERload: overload frame

ERRor: error frame

DTA11: data frame with 11bit identifier

DTA29: data frame with 29bit identifier

REM11: remote frame with 11bit identifier

REM29: remote frame with 29bit identifier

*RST: SOF

SEARCH:PROTOCOL:CAN:ACKerror <AcknowledgeError>

Searches for acknowledgement errors. An acknowledgement error occurs when the transmitter does not receive an acknowledgment - a dominant bit during the Ack Slot.

The command is relevant if `SEARCH:PROTOCOL:CAN:CONDITION` is set to `ERRor` or `IDERRor`.

Parameters:

<AcknowledgeError> ON | OFF

*RST: OFF

SEARCh:PROTOcol:CAN:BITSterror <BitStuffingError>

Searches for bit stuffing errors.

See also: "Stuff Bit" on page 271.

The command is relevant if `SEARCh:PROTOcol:CAN:CONDition` is set to `ERRor` or `IDERRor`.

Parameters:

<BitStuffingError> ON | OFF
 *RST: OFF

SEARCh:PROTOcol:CAN:CRCError <CRCError>

Searches for errors in the Cyclic Redundancy Check.

The command is relevant if `SEARCh:PROTOcol:CAN:CONDition` is set to `ERRor` or `IDERRor`.

Parameters:

<CRCError> ON | OFF
 *RST: OFF

SEARCh:PROTOcol:CAN:FORMerror <FormError>

Searches for form errors. A form error occurs when a fixed-form bit field contains one or more illegal bits.

The command is relevant if `SEARCh:PROTOcol:CAN:CONDition` is set to `ERRor` or `IDERRor`.

Parameters:

<FormError> ON | OFF
 *RST: OFF

SEARCh:PROTOcol:CAN:FTYPE <FrameType>

Specifies the frame type to be searched for if `SEARCh:PROTOcol:CAN:CONDition` is set to `IDENtifier`.

Parameters:

<FrameType> DATA | REMote | ANY

SEARCh:PROTOcol:CAN:ITYPE <IdType>

Selects the length of the identifier: 11 bit for CAN base frames, or 29 bits for CAN extended frames.

The command is relevant if `SEARCh:PROTOcol:CAN:CONDition` is set to `IDENtifier`, `IDData`, or `IDERRor`.

Parameters:

<IdType> B11 | B29
 *RST: B11

SEARCH:PROTocol:CAN:ICONdition <IdCondition>

Sets the comparison condition for the identifier: If the pattern contains at least one X (don't care), you can trigger on values equal or not equal to the specified value. If the pattern contains only 0 and 1, you can also trigger on a range greater than or lower than the specified value.

The command is relevant if [SEARCH:PROTocol:CAN:CONDition](#) is set to IDENTifier, IDData, or IDERror.

Parameters:

<IdCondition> EQUal | NEQual | GTHan | LTHan
 *RST: EQU

SEARCH:PROTocol:CAN:IDENTifier <Identifier>

Defines the identifier pattern. The pattern length is defined with [SEARCH:PROTocol:CAN:ITYPE](#).

The command is relevant if [SEARCH:PROTocol:CAN:CONDition](#) is set to IDENTifier, IDData, or IDERror.

Parameters:

<Identifier> String containing binary pattern with max. 29 bit. Characters 0, 1, and X are allowed.

SEARCH:PROTocol:CAN:DLENgth <DataLength>

Defines the length of the data pattern - the number of bytes in the pattern.

The command is relevant if [SEARCH:PROTocol:CAN:CONDition](#) is set to IDData.

Parameters:

<DataLength> Range: 0 to 8
 Increment: 1
 *RST: 1
 Default unit: Byte

SEARCH:PROTocol:CAN:DCONDition <DataCondition>

Sets the comparison condition for data: If the pattern contains at least one X (don't care), you can trigger on values equal or not equal to the specified value. If the pattern contains only 0 and 1, you can also trigger on a range greater than or lower than the specified value.

The command is relevant if [SEARCH:PROTocol:CAN:CONDition](#) is set to IDData.

Parameters:

<DataCondition> EQUal | NEQual | GTHan | LTHan
 *RST: EQU

SEARCH:PROTOCOL:CAN:DATA <Data>

Defines the data pattern. The pattern length is defined with [SEARCH:PROTOCOL:CAN:DLNGTH](#).

The command is relevant if [SEARCH:PROTOCOL:CAN:CONDITION](#) is set to IDData.

Parameters:

<Data> String containing binary pattern with max. 64 bit. Characters 0, 1, and X are allowed. Make sure to enter complete bytes.

16.11.6 LIN (Option R&S RTM-K3)

The Local Interconnect Network (LIN) is a simple, low-cost bus system used within automotive network architectures.

Note: SPI and UART protocols occupy two bus lines (bus 1 and 2 or bus 3 and 4). If one of these buses is configured, the number of buses (suffix) is reduced. Bus 2 and/or bus 4 is not available.

- [LIN - Configuration](#)..... 624
- [LIN - Trigger](#)..... 625
- [LIN - Decode Results](#)..... 628
- [LIN - Search](#)..... 634

16.11.6.1 LIN - Configuration

Start the bus configuration with the threshold setting. Use one of the following commands:

- [CHANNEL<m>:THRESHOLD:FINDLEVEL](#) on page 422
- [CHANNEL<m>:THRESHOLD](#) on page 421

In all [BUS:LIN...](#) commands, the suffix selects the bus.

- [BUS:LIN:DATA:SOURCE](#)..... 624
- [BUS:LIN:POLARITY](#)..... 625
- [BUS:LIN:STANDARD](#)..... 625
- [BUS:LIN:BITRATE](#)..... 625

BUS:LIN:DATA:SOURCE <Source>

Sets the source of the data line. All channel waveforms can be used.

Suffix:

 1..4

Parameters:

<Source> CH1 | CH2 | CH3 | CH4 | D0..D15
 *RST: CH1

BUS:LIN:POLarity <Polarity>

Defines the idle state of the bus. The idle state is the recessive state and corresponds to a logic 1.

Suffix:

 1..4

Parameters:

<Polarity> IDLHigh | IDLLow
 IDLHigh: Low active, negative polarity
 IDLLow: High active, positive polarity
 *RST: IDLL

BUS:LIN:STANdard <Standard>

Selects the version of the LIN standard that is used in the DUT. The setting mainly defines the checksum version used during decoding.

The most common version is LIN 2.x. For mixed networks, or if the standard is unknown, set the LIN standard to AUTO.

Suffix:

 1..4

Parameters:

<Standard> V1X | V2X | J2602 | AUTO
 *RST: V1X

BUS:LIN:BITRate <BitRate>

Sets the number of transmitted bits per second.

Suffix:

 1..4

Parameters:

<BitRate> Range: 100 bit/s to 5 Mbit/s
 *RST: 9,6E03
 Default unit: Bit/s

16.11.6.2 LIN - Trigger

To configure the protocol trigger, make sure to set first:

- `TRIGger:A:TYPE` to `BUS`

- `TRIGger:A:SOURce` to SBUS1 | SBUS2

| | |
|---|-----|
| <code>TRIGger:A:LIN:TYPE</code> | 626 |
| <code>TRIGger:A:LIN:CHKSError</code> | 626 |
| <code>TRIGger:A:LIN:IPERror</code> | 627 |
| <code>TRIGger:A:LIN:SYERror</code> | 627 |
| <code>TRIGger:A:LIN:ICONdition</code> | 627 |
| <code>TRIGger:A:LIN:IDENTifier</code> | 627 |
| <code>TRIGger:A:LIN:DATA</code> | 627 |
| <code>TRIGger:A:LIN:DCONdition</code> | 628 |
| <code>TRIGger:A:LIN:DLENgth</code> | 628 |

`TRIGger:A:LIN:TYPE` <TriggerType>

Specifies the trigger mode for LIN.

Parameters:

<TriggerType> SYNC | WKFRame | ID | IDDT | ERRCondition

SYNC

Start of frame, triggers on the stop bit of the sync field.

WKFRame

Triggers after a wakeup frame.

ID

Sets the trigger to a specific identifier or an identifier range.

Set the identifier with `TRIGger:A:LIN:ICONdition` and `TRIGger:A:LIN:IDENTifier`.

IDDT

Set the identifier (see ID) and the data with `TRIGger:A:LIN:DLENgth`, `TRIGger:A:LIN:DCONdition` and `TRIGger:A:LIN:DATA`.

ERRCondition

Identifies various errors in the frame. You can select one or more error types as trigger condition.

Select the error types with `TRIGger:A:LIN:CHKSError`, `TRIGger:A:LIN:IPERror` and `TRIGger:A:LIN:SYERror`.

*RST: SYNC

`TRIGger:A:LIN:CHKSError` <ChecksumError>

Triggers on a checksum error. The checksum verifies the correct data transmission. It is the last byte of the frame response. The checksum includes not only the data but also the protected identifier (PID).

The command is relevant if `TRIGger:A:LIN:TYPE` is set to `ERRCondition`.

Parameters:

<ChecksumError> ON | OFF

*RST: ON

TRIGger:A:LIN:IPERror <IdParityError>

Triggers on a parity error. Parity bits are the bits 6 and 7 of the identifier. They verify the correct transmission of the identifier.

The command is relevant if **TRIGger:A:LIN:TYPE** is set to **ERRCondition**.

Parameters:

<IdParityError> ON | OFF
*RST: OFF

TRIGger:A:LIN:SYERror <SyncError>

Triggers if synchronization caused an error.

The command is relevant if **TRIGger:A:LIN:TYPE** is set to **ERRCondition**.

Parameters:

<SyncError> ON | OFF
*RST: OFF

TRIGger:A:LIN:ICONdition <IdentifierCondition>

Sets the comparison condition for the identifier: If the pattern contains at least one X (don't care), you can trigger on values equal or not equal to the specified value. If the pattern contains only 0 and 1, you can also trigger on a range greater than or lower than the specified value.

The command is relevant if **TRIGger:A:LIN:TYPE** is set to **ID** or **IDDT**.

Parameters:

<IdentifierCondition> EQUal | NEQual | GTHan | LTHan
*RST: EQ

TRIGger:A:LIN:IDENTifier <Identifier>

Defines the identifier pattern.

The command is relevant if **TRIGger:A:LIN:TYPE** is set to **ID** or **IDDT**.

Parameters:

<Identifier> String containing binary pattern. Characters 0, 1, and X are allowed. Enter the 6 bit identifier without parity bits, not the protected identifier.

TRIGger:A:LIN:DATA <Data>

Defines the data pattern. The number of bytes in the data pattern is defined with **TRIGger:A:LIN:DLENgth**.

The command is relevant if **TRIGger:A:LIN:TYPE** is set to **IDDT**.

Parameters:

<Data> String containing binary pattern with max. 64 bit. Characters 0, 1, and X are allowed. Make sure to enter complete bytes.

TRIGger:A:LIN:DCondition <DataCondition>

Sets the comparison condition for data: If the pattern contains at least one X (don't care), you can trigger on values equal or not equal to the specified value. If the pattern contains only 0 and 1, you can also trigger on a range greater than or lower than the specified value.

The command is relevant if `TRIGger:A:LIN:TYPE` is set to `IDDT`.

Parameters:

<DataCondition> `EQUal` | `NEQual` | `GTHan` | `LTHan`
 *RST: `EQ`

TRIGger:A:LIN:DLEnGth <DataLength>

Defines the length of the data pattern - the number of bytes in the pattern.

The command is relevant if `TRIGger:A:LIN:TYPE` is set to `IDDT`.

Parameters:

<DataLength> Range: 1 to 8
 Increment: 1
 *RST: 1
 Default unit: Byte

16.11.6.3 LIN - Decode Results

In all `BUS:LIN...` commands, the suffix `` selects the bus.

| | |
|---|-----|
| <code>BUS:LIN:FCOut?</code> | 629 |
| <code>BUS:LIN:FRAMe<n>:DATA?</code> | 629 |
| <code>BUS:LIN:FRAMe<n>:STATus?</code> | 629 |
| <code>BUS:LIN:FRAMe<n>:START?</code> | 629 |
| <code>BUS:LIN:FRAMe<n>:STOP?</code> | 630 |
| <code>BUS:LIN:FRAMe<n>:CSStAtE?</code> | 630 |
| <code>BUS:LIN:FRAMe<n>:CSVAlue?</code> | 630 |
| <code>BUS:LIN:FRAMe<n>:IDPValue?</code> | 631 |
| <code>BUS:LIN:FRAMe<n>:IDStAtE?</code> | 631 |
| <code>BUS:LIN:FRAMe<n>:IDVAlue?</code> | 631 |
| <code>BUS:LIN:FRAMe<n>:SYStAtE?</code> | 632 |
| <code>BUS:LIN:FRAMe<n>:SYVAlue?</code> | 632 |
| <code>BUS:LIN:FRAMe<n>:VERSiOn?</code> | 632 |
| <code>BUS:LIN:FRAMe<n>:BCOut?</code> | 632 |
| <code>BUS:LIN:FRAMe<n>:BYTE<o>:StAtE?</code> | 633 |
| <code>BUS:LIN:FRAMe<n>:BYTE<o>:VAlue?</code> | 633 |

BUS:LIN:FCOunt?

Returns the number of received frames of the active LIN bus.

Suffix:

 1..4

Return values:

<FrameCount> Total number of decoded frames.

Usage: Query only

BUS:LIN:FRAMe<n>:DATA?

Returns the data bytes of the specified frame.

Suffix:

 1..4

<n> *

Selects the frame (1...n).

Return values:

<FrameData> Comma-separated list of decimal values of the data bytes.

Usage: Query only

BUS:LIN:FRAMe<n>:STATus?

Returns the overall state of the specified frame.

Suffix:

 1..4

<n> *

Selects the frame (1...n).

Return values:

<FrameStatus> OK | UART | CHCKsum | PRERror | SYERror | WAKeup |
INSufficient | ERR | LENer

Usage: Query only

BUS:LIN:FRAMe<n>:START?

Returns the start time of the specified frame.

Suffix:

 1..4

<n> *

Selects the frame (1...n).

Return values:

<StartTime> Range: depends on sample rate, record length, and time base
 Increment: depends on the time base
 Default unit: s

Usage: Query only

BUS:LIN:FRAME<n>:STOP?

Returns the end time of the specified frame.

Suffix:

 1..4

<n> *

Selects the frame (1...n).

Return values:

<StopTime> Range: depends on sample rate, record length, and time base
 Increment: depends on the time base
 Default unit: s

Usage: Query only

BUS:LIN:FRAME<n>:CSState?

Returns the checksum state of the specified frame.

Suffix:

 1..4

<n> *

Selects the frame (1...n).

Return values:

<ChecksumState> OK | ERR | UNDF
 ERR: error
 UNDF: undefined

Usage: Query only

BUS:LIN:FRAME<n>:CSValue?

Returns the checksum value.

Suffix:

 1..4

<n> *

Selects the frame (1...n).

Return values:
 <ChecksumValue> Decimal value

Usage: Query only

BUS:LIN:FRAMe<n>:IDPValue?

Returns the parity value.

Suffix:
 1..4
 <n> *
 Selects the frame (1...n).

Return values:
 <IdentifierParityValue>Decimal value

Usage: Query only

BUS:LIN:FRAMe<n>:IDStAtE?

Returns the identifier state of the selected frame.

Suffix:
 1..4
 <n> *
 Selects the frame (1...n).

Return values:
 <IdentifierState> OK | PRERror | UVAL | INSufficient
 PRERror: parity error
 UVAL: unexpected value
 INSufficient: the frame is not completely contained in the acquisition. The decoded part of the frame is valid.

Usage: Query only

BUS:LIN:FRAMe<n>:IDValue?

Returns the identifier value (address)

Suffix:
 1..4
 <n> *
 Selects the frame (1...n).

Return values:
 <IdentifierValue> Decimal value

Usage: Query only

BUS:LIN:FRAME<n>:SYSTate?

Returns the state of the sync field for the specified frame.

Suffix:

| | |
|-----|------|
| | 1..4 |
| <n> | * |

Selects the frame (1...n).

Return values:

| | |
|------------------|-----------------|
| <SyncFieldState> | OK ERR UNDF |
| | ERR: error |
| | UNDF: undefined |

Usage: Query only

BUS:LIN:FRAME<n>:SYValue?

Returns the value of the synchronization field.

Suffix:

| | |
|-----|------|
| | 1..4 |
| <n> | * |

Selects the frame (1...n).

Return values:

| | |
|------------------|---------------|
| <SyncFieldValue> | Decimal value |
|------------------|---------------|

Usage: Query only

BUS:LIN:FRAME<n>:VERSion?

Returns the version of the LIN standard for the specified frame.

Suffix:

| | |
|-----|------|
| | 1..4 |
| <n> | * |

Selects the frame (1...n).

Return values:

| | |
|----------------|-----------------|
| <FrameVersion> | V1X V2X UNK |
| | UNK: Unknown |

Usage: Query only

BUS:LIN:FRAME<n>:BCOunt?

Returns the number of data bytes in the specified frame.

Suffix:

| | |
|-----|------|
| | 1..4 |
|-----|------|

<n> *
Selects the frame (1...n).

Return values:

<ByteCount> Number of words (bytes)

Usage: Query only

BUS:LIN:FRAMe<n>:BYTE<o>:STATe?

Returns the state of the specified data byte.

Suffix:

 1..4

<n> *
Selects the frame (1...n).

<o> *
Selects the byte number (1...o).

Return values:

<ByteStatus> OK | INS | UART

INS

Insufficient, the byte is not completely contained in the acquisition.

UART

At least one UART error occurred. LIN uses UART words without parity bit.

Usage: Query only

BUS:LIN:FRAMe<n>:BYTE<o>:VALue?

Returns the decimal value of the specified byte.

Suffix:

 1..4

<n> *
Selects the frame (1...n).

<o> *
Selects the byte number (1...o).

Return values:

<ByteValue> Decimal value

Usage: Query only

16.11.6.4 LIN - Search

| | |
|-------------------------------------|-----|
| SEARCh:PROTocol:LIN:CONDition..... | 634 |
| SEARCh:PROTocol:LIN:FRAMe..... | 634 |
| SEARCh:PROTocol:LIN:IPERror..... | 635 |
| SEARCh:PROTocol:LIN:CHKSError..... | 635 |
| SEARCh:PROTocol:LIN:SYERror..... | 635 |
| SEARCh:PROTocol:LIN:ICONdition..... | 635 |
| SEARCh:PROTocol:LIN:IDENtifier..... | 636 |
| SEARCh:PROTocol:LIN:DLENgth..... | 636 |
| SEARCh:PROTocol:LIN:DCONdition..... | 636 |
| SEARCh:PROTocol:LIN:DATA..... | 636 |

SEARCh:PROTocol:LIN:CONDition <SearchCondition>

Sets the event or combination of events to be searched for. Depending on the selected event, further settings are required.

Parameters:

<SearchCondition> FRAME | ERRor | IDENtifier | IDData | IDERror

FRAMe

Search for a frame type.

Set the frame type with `SEARCh:PROTocol:LIN:FRAMe`.

ERRor

Search for errors of one or more error types.

Set the error types with `SEARCh:PROTocol:LIN:CHKSError`, `SEARCh:PROTocol:LIN:IPERror` and `SEARCh:PROTocol:LIN:SYERror`.

IDENtifier

Search for identifier.

Specify the identifier with `SEARCh:PROTocol:LIN:ICONdition` and `SEARCh:PROTocol:LIN:IDENtifier`.

IDData

Search for identifier and data.

Set the identifier (see `IDENtifier`) and the data with `SEARCh:PROTocol:LIN:DLENgth`, `SEARCh:PROTocol:LIN:DCONdition` and `SEARCh:PROTocol:LIN:DATA`.

IDERror

Search for errors that occur with a specified identifier. Set the identifier (see `IDENtifier`) and the errors to be found (see `ERRor`).

*RST: FRAM

SEARCh:PROTocol:LIN:FRAMe <Frame>

Selects the frame type to be searched for.

The command is relevant if `SEARCh:PROTocol:LIN:CONDition` is set to `FRAMe`.

Parameters:

<Frame> SOF | WAKEup
 SOF: start of frame
 WAKEup: Wakeup frame
 *RST: SOF

SEARCH:PROTOCOL:LIN:IPERror <IdParityError>

Searches for parity errors.

The command is relevant if [SEARCH:PROTOCOL:LIN:CONDition](#) is set to `ERRor` or `IDERRor`.

Parameters:

<IdParityError> ON | OFF
 *RST: OFF

SEARCH:PROTOCOL:LIN:CHKSError <ChecksumError>

Searches for checksum errors.

The command is relevant if [SEARCH:PROTOCOL:LIN:CONDition](#) is set to `ERRor` or `IDERRor`.

Parameters:

<ChecksumError> ON | OFF
 *RST: OFF

SEARCH:PROTOCOL:LIN:SYERror <SyncError>

Searches for synchronization errors.

The command is relevant if [SEARCH:PROTOCOL:LIN:CONDition](#) is set to `ERRor` or `IDERRor`.

Parameters:

<SyncError> ON | OFF
 *RST: OFF

SEARCH:PROTOCOL:LIN:ICONdition <IdCondition>

Sets the comparison condition for the identifier: If the pattern contains at least one X (don't care), you can trigger on values equal or not equal to the specified value. If the pattern contains only 0 and 1, you can also trigger on a range greater than or lower than the specified value.

The command is relevant if [SEARCH:PROTOCOL:LIN:CONDition](#) is set to `IDENtifier`, `IDData` or `IDERRor`.

Parameters:

<IdCondition> EQUal | NEQual | GTHan | LTHan
 *RST: EQU

SEARCH:PROTOCOL:LIN:IDENTIFIER <Identifier>

Defines the identifier pattern.

The command is relevant if `SEARCH:PROTOCOL:LIN:CONDITION` is set to `IDENTIFIER`, `IDDATA` or `IDERROR`.

Parameters:

<Identifier> String containing binary pattern. Characters 0, 1, and X are allowed. Enter the 6 bit identifier without parity bits, not the protected identifier.

SEARCH:PROTOCOL:LIN:DLENGTH <DataLength>

Defines the length of the data pattern - the number of bytes in the pattern.

The command is relevant if `SEARCH:PROTOCOL:LIN:CONDITION` is set to `IDDATA`.

Parameters:

<DataLength> Range: 1 to 8
 Increment: 1
 *RST: 1
 Default unit: Byte

SEARCH:PROTOCOL:LIN:DCONDITION <DataCondition>

Sets the comparison condition for data: If the pattern contains at least one X (don't care), you can trigger on values equal or not equal to the specified value. If the pattern contains only 0 and 1, you can also trigger on a range greater than or lower than the specified value.

The command is relevant if `SEARCH:PROTOCOL:LIN:CONDITION` is set to `IDDATA`.

Parameters:

<DataCondition> EQUal | NEQual | GTHan | LTHan
 *RST: EQU

SEARCH:PROTOCOL:LIN:DATA <Data>

Defines the data pattern. The pattern length is defined with `SEARCH:PROTOCOL:LIN:DLENGTH`.

The command is relevant if `SEARCH:PROTOCOL:LIN:CONDITION` is set to `IDDATA`.

Parameters:

<Data> String containing binary pattern with max. 64 bit. Characters 0, 1, and X are allowed. Make sure to enter complete bytes.

16.11.7 Audio (Option R&S RTM-K5)

- [Audio Configuration](#)..... 637
- [Audio Trigger](#)..... 642
- [Audio Decode Results](#)..... 646

16.11.7.1 Audio Configuration

| | |
|--|-----|
| BUS:I2S:AVARiant | 637 |
| BUS:I2S:BORDer | 637 |
| BUS:I2S:CHANnel:LENGth | 638 |
| BUS:I2S:CHANnel:OFFSet | 638 |
| BUS:I2S:CHANnel:ORDer | 638 |
| BUS:I2S:CHANnel:TDMCount | 638 |
| BUS:I2S:CLOCK:POLarity | 639 |
| BUS:I2S:CLOCK:SOURce | 639 |
| BUS:I2S:CLOCK:THReshold | 639 |
| BUS:I2S:DATA:POLarity | 639 |
| BUS:I2S:DATA:SOURce | 640 |
| BUS:I2S:DATA:THReshold | 640 |
| BUS:I2S:DISPlay | 640 |
| BUS:I2S:FOFFset | 641 |
| BUS:I2S:WLENGth | 641 |
| BUS:I2S:WSElect:POLarity | 641 |
| BUS:I2S:WSElect:SOURce | 642 |
| BUS:I2S:WSElect:THReshold | 642 |

BUS:I2S:AVARiant <AudioVariant>

Selects the protocol variant of the audio signal.

Suffix:

 1..4

Parameters:

<AudioVariant> I2S | LJ | RJ | TDM | DSP

I2S: Inter-IC sound standard audio format.

LJ: left justified data format

RJ: right justified data format

TDM: time division multiplexed audio format to transfer up to 8 audio data channels on one line

*RST: I2S

BUS:I2S:BORDer <BitOrder>

Sets the bit order in the audio data words. Usually, the MSB is transmitted first.

Suffix:

 1..4

Parameters:

<BitOrder> MSBFirst | LSBFirst
 MSBFirst: most significant bit is transmitted first
 LSBFirst: least significant bit is transmitted first
 *RST: MSBF

BUS:I2S:CHANnel:LENGth <ChannelLength>

Sets the number of bits in a channel block for TDM audio signals (transmitter length).

The setting is available only if **BUS:I2S:AVARiant** is set to TDM.

Suffix:

 1..4

Parameters:

<ChannelLength> *RST: 8
 Default unit: Bit

BUS:I2S:CHANnel:OFFSet <ChannelOffset>

Sets the number of bits between the channel start and the start of the audio word.

The setting is available only, if **BUS:I2S:AVARiant** is set to TDM or LJ.

Suffix:

 1..4

Parameters:

<ChannelOffset> *RST: 1
 Default unit: Bit

BUS:I2S:CHANnel:ORDer <ChannelOrder>

Defines if the left or the right channel is the first channel in the frame.

The setting is available for I²S standard, left and right justified audio signals.

Suffix:

 1..4

Parameters:

<ChannelOrder> LFIRst | RFIRst
 LFIRst: left channel first
 RFIRst: right channel first
 *RST: LFIR

BUS:I2S:CHANnel:TDMCount <ChannelCount>

Sets the number of channels transmitted on the TDM audio line.

Suffix:

 1..4

Parameters:

<ChannelCount> *RST: 8
 Default unit: Channel

BUS:I2S:CLOCK:POLarity <ClockSlope>

Sets the clock edge at which the instrument samples the data on the data line. Usually, the rising edge is used. The R&S RTM3000 can also analyze the converse setup.

Suffix:

 1..4

Parameters:

<ClockSlope> RISing | FALLing
 *RST: RIS

BUS:I2S:CLOCK:SOURce <ClockSource>

Selects the source of the clock line.

Suffix:

 1..4

Parameters:

<ClockSource> CH1 | CH2 | CH3 | CH4 | D0..15
 CH3 and CH4 are only available with 4-channel R&S RTM3000 oscilloscopes.
 *RST: CH2

BUS:I2S:CLOCK:THReshold <Threshold>

Sets the threshold for the clock line.

Suffix:

 1..4

Parameters:

<Threshold> *RST: 1.4
 Default unit: V

BUS:I2S:DATA:POLarity <DataPolarity>

Defines the interpretation of high and low signal states.

Suffix:

 1..4

Parameters:

<DataPolarity> ACTHigh | ACTLow

ACTHigh

Active high: HIGH (signal level above the threshold level) = 1
and LOW (signal level below the threshold level) = 0

ACTLow

Active low: HIGH = 0 and LOW = 1

*RST: ACTH

BUS:I2S:DATA:SOURce <DataSource>

Selects the source of the data line.

Suffix:

 1..4

Parameters:

<DataSource> CH1 | CH2 | CH3 | CH4 | D0..15

CH3 and CH4 are only available with 4-channel R&S RTM3000 oscilloscopes.

*RST: CH3

BUS:I2S:DATA:THReshold <Threshold>

Sets the threshold for the indicated audio line.

Suffix:

 1..4

Parameters:

<Threshold> *RST: 1.4

Default unit: V

BUS:I2S:DISPlay <DisplayMode>

Defines how the decoded bus, the bit lines of the channels, and the track waveforms are displayed.

Suffix:

 1..4

Parameters:

<DisplayMode> SEQuential | PARAllel | STRack | PTRack | TRACk | SDSignal

SEQuential

The decoded data words of the channels are shown in sequential, horizontal order.

PARAllel

The decoded data words of the channels are arranged vertically.

STRack

Sequential order of data words, and tracks

PTRack

Parallel order of data words, and tracks

TRACK

Only tracks

SDSignal

Sequential order of data words, and bit lines of the channels

BUS:I2S:FOFFset <FrameOffset>

Sets a delay of the channel blocks after the frame start (word select edge). Thus, all channels are shifted.

Suffix:

 1..4

Parameters:

<FrameOffset> *RST: 0
Default unit: Bit

BUS:I2S:WLENgth <WordLength>

Defines the number of bits in an audio data word (receiver length).

Suffix:

 1..4

Parameters:

<WordLength> Range: The minimum length is 1bit, the maximum length is the channel length.
*RST: 8
Default unit: Bit

BUS:I2S:WSElect:POLarity <WordSelectPolarity>

For I²S, left and right justified signals (BUS:I2S:AVARiant is set to I2S/LJ/RJ), the polarity defines the word select values assigned to the left and right channels.

For TDM signals (BUS:I2S:AVARiant is set to TDM), the polarity defines the edge of the frame synchronization pulse that identifies the beginning of a frame.

Suffix:

 1..4

Parameters:

<WordSelectPolarity> NORMAl | INVert

NORMAl

0 indicates the left channel, and 1 indicates the right channel. This is the usual setting.

TDM: the frame begins with a rising edge. This is the usual setting.

INVert

0 indicates the right channel, and 1 the left channel.

TDM: the frame begins with a falling edge.

*RST: NORM

BUS:I2S:WSElect:SOURce <WordSelectSource>

Selects the source of the word select line.

Suffix:

 1..4

Parameters:

<WordSelectSource> CH1 | CH2 | CH3 | CH4 | D0..15

CH3 and CH4 are only available with 4-channel R&S RTM3000 oscilloscopes.

*RST: CH1

BUS:I2S:WSElect:THReshold <Threshold>

Sets the threshold for the indicated audio line.

Suffix:

 1..4

Parameters:

<Threshold> s

*RST: 1.4

16.11.7.2 Audio Trigger

| | |
|--|-----|
| BUS:I2S:FCOut? | 643 |
| TRIGger:A:I2S:CHANnel:LEFT:CONDition | 643 |
| TRIGger:A:I2S:CHANnel:LEFT:DMAX | 643 |
| TRIGger:A:I2S:CHANnel:LEFT:DMIN | 643 |
| TRIGger:A:I2S:CHANnel:RIGHT:CONDition | 644 |
| TRIGger:A:I2S:CHANnel:RIGHT:DMAX | 644 |
| TRIGger:A:I2S:CHANnel:RIGHT:DMIN | 644 |
| TRIGger:A:I2S:CHANnel:TDM<n>:CONDition | 644 |
| TRIGger:A:I2S:CHANnel:TDM<n>:DMAX | 645 |
| TRIGger:A:I2S:CHANnel:TDM<n>:DMIN | 645 |
| TRIGger:A:I2S:FUNction | 645 |
| TRIGger:A:I2S:TYPE | 645 |
| TRIGger:A:I2S:SOWords | 646 |
| TRIGger:A:I2S:WINDow:LENGth | 646 |
| TRIGger:A:I2S:WSElect:SLOPe | 646 |
| TRIGger:A:I2S:WSSLOPe | 646 |

BUS:I2S:FCOut?

Returns the number of decoded frames.

Suffix:

 1..4

Return values:

<FrameCount>

Usage: Query only

TRIGger:A:I2S:CHANnel:LEFT:CONDition <Comparison>

Define the operators for comparison of the decoded data words with the specified data words on the specified channel.

Parameters:

<Comparison> OFF | EQUal | NEQual | GTHan | LTHan | INRange | OORange

INRange: in range

OORange: out of range

OFF

No range is defined.

EQUal | NEQual | GTHan | LTHan

Equal, not equal, greater than, less than. These conditions require one data word to be set with [TRIGger:A:I2S:CHANnel:LEFT:DMIN](#).

TRIGger:A:I2S:CHANnel:LEFT:DMAX <MaximumValue>

Specifies the maximum data value to be found, if [TRIGger:A:I2S:CHANnel:LEFT:CONDition](#) is set to [INRange](#) or [OORange](#)

Parameters:

<MaximumValue> The data format is decimal. The maximum value is limited by the word length. Consider that audio words are signed numbers in 2's complement format. For example, an 8-bit data word has a value range from -128 to 127.

TRIGger:A:I2S:CHANnel:LEFT:DMIN <MinimumValue>

Specifies a data pattern, or sets the the start value of a data pattern range.

Parameters:

<MinimumValue>

TRIGger:A:I2S:CHANnel:RIGHT:CONDition <Comparison>

Define the operators for comparison of the decoded data words with the specified data words on the specified channel.

Parameters:

<Comparison> OFF | EQUAL | NEQUAL | GTHan | LTHan | INRange | OORange

INRange: in range

OORange: out of range

OFF

No range is defined.

EQUAL | NEQUAL | GTHan | LTHan

Equal, not equal, greater than, less than. These conditions require one data word to be set with [TRIGger:A:I2S:CHANnel:RIGHT:DMIN](#) on page 644.

TRIGger:A:I2S:CHANnel:RIGHT:DMAX <MaximumValue>

Specifies the maximum data value to be found, if [TRIGger:A:I2S:CHANnel:RIGHT:CONDition](#) is set to INRange or OORange

Parameters:

<MaximumValue> The data format is decimal. The maximum value is limited by the word length. Consider that audio words are signed numbers in 2's complement format. For example, an 8-bit data word has a value range from -128 to 127.

TRIGger:A:I2S:CHANnel:RIGHT:DMIN <MinimumValue>

Specifies a data pattern, or sets the the start value of a data pattern range.

Parameters:

<MinimumValue>

TRIGger:A:I2S:CHANnel:TDM<n>:CONDition <Comparison>

Define the operators for comparison of the decoded data words with the specified data words on the specified channel.

Parameters:

<Comparison> OFF | EQUAL | NEQUAL | GTHan | LTHan | INRange | OORange

INRange: in range

OORange: out of range

OFF

No range is defined.

EQUal | NEQual | GTHan | LTHan

Equal, not equal, greater than, less than. These conditions require one data word to be set with `TRIGger:A:I2S:CHANnel:TDM<n>:DMIN`.

TRIGger:A:I2S:CHANnel:TDM<n>:DMAX <MaximumValue>

Specifies the maximum data value to be found, if `TRIGger:A:I2S:CHANnel:TDM<n>:CONDition` is set to `INRange` or `ORange`

Parameters:

<MaximumValue> The data format is decimal. The maximum value is limited by the word length. Consider that audio words are signed numbers in 2's complement format. For example, an 8-bit data word has a value range from -128 to 127.

TRIGger:A:I2S:CHANnel:TDM<n>:DMIN <MinimumValue>

Specifies a data pattern, or sets the the start value of a data pattern range.

Parameters:

<MinimumValue>

TRIGger:A:I2S:FUNcTion <Function>

Sets the logical combination to trigger on data words on different channels. The instrument triggers if all conditions are met inside one frame.

The setting is relevant, if `TRIGger:A:I2S:TYPE` is set to `DATA` or `WINDow`.

Parameters:

<Function> AND | OR

TRIGger:A:I2S:TYPE <TriggerMode>

Specifies the trigger mode for audio signals.

Parameters:

<TriggerMode> DATA | WINDow | WSElect | ERRCondition

DATA

Triggers on a data word or a data range that occurs on a specified channel. You can also trigger on an AND combination of data conditions on different channels.

Use the `TRIGger:A:I2S:CHANnel:LEFT:CONDition` commands to define the data condition.

To set the logical combination to trigger on data words on different channels, use `TRIGger:A:I2S:FUNcTion`.

WINDow

Triggers if the data conditions are fulfilled at least for the given number of subsequent frames. Uses the data trigger commands to define the data condition. Use `TRIGger:A:I2S:WINDow:LENGth` to set the time limit.

WSElect

Sets the edge of the word select signal as trigger condition. Use `TRIGger:A:I2S:WSSLOpe` to set the edge.

ERRCondition

An error is detected when two consecutive frames have different length. The instrument triggers on the first clock edge after error detection.

TRIGger:A:I2S:SOWords <WindowLength>

TRIGger:A:I2S:WINDow:LENGth <WindowLength>

Sets the number of subsequent frames (audio samples) for which the data conditions are fulfilled.

Parameters:

<WindowLength>

TRIGger:A:I2S:WSElect:SLOPe <WordSelectSlope>

TRIGger:A:I2S:WSSLOpe <WordSelectSlope>

Sets the edge of the word select signal as trigger condition.

Parameters:

<WordSelectSlope> POS | NEG

16.11.7.3 Audio Decode Results

| | |
|--|-----|
| <code>BUS:I2S:FRAMe<n>:LEFT:STATe?</code> | 646 |
| <code>BUS:I2S:FRAMe<n>:LEFT:VALue?</code> | 647 |
| <code>BUS:I2S:FRAMe<n>:RIGHT:STATe?</code> | 647 |
| <code>BUS:I2S:FRAMe<n>:RIGHT:VALue?</code> | 647 |
| <code>BUS:I2S:FRAMe<n>:STARt?</code> | 648 |
| <code>BUS:I2S:FRAMe<n>:STATe?</code> | 648 |
| <code>BUS:I2S:FRAMe<n>:STOP?</code> | 648 |
| <code>BUS:I2S:FRAMe<n>:TDM<o>:STATe?</code> | 648 |
| <code>BUS:I2S:FRAMe<n>:TDM<o>:VALue?</code> | 649 |

BUS:I2S:FRAMe<n>:LEFT:STATe?

Returns the state of the specified frame on the left audio channel.

Suffix:

 1..4

<n> *

Return values:

<State> ERRor | OK | INSufficient
 ERRor: an error ocured in the frame.
 OK: frame is valid.
 INSufficient: frame is not completely contained in the acquisition. The acquired part of the frame is valid.

Usage: Query only

BUS:I2S:FRAMe<n>:LEFT:VALue?

Returns the data word of the specified frame on the left audio channel.

Suffix:

 1..4
 <n> *

Return values:

<Value> Signed decimal value

Usage: Query only

BUS:I2S:FRAMe<n>:RIGHT:STATe?

Returns the state of the specified frame on the right or left audio channel.

Suffix:

 1..4
 <n> *

Return values:

<State> ERRor | OK | INSufficient
 ERRor: an error ocured in the frame.
 OK: frame is valid.
 INSufficient: frame is not completely contained in the acquisition. The acquired part of the frame is valid.

Usage: Query only

BUS:I2S:FRAMe<n>:RIGHT:VALue?

Returns the data word of the specified frame on the right audio channel.

Suffix:

 1..4
 <n> *

Return values:

<Value> Signed decimal value

Usage: Query only

BUS:I2S:FRAME<n>:START?

Returns the start time of the specified frame.

Suffix:

| | |
|-----|------|
| | 1..4 |
| <n> | * |

Return values:

| | | |
|-------------|------------|--|
| <StartTime> | Range: | depends on sample rate, record length, and time base |
| | Increment: | depends on the time base |

Usage: Query only

BUS:I2S:FRAME<n>:STATe?

Returns the state of the specified frame on the right audio channel.

Suffix:

| | |
|-----|------|
| | 1..4 |
| <n> | * |

Return values:

| | |
|--------------|---------------------------|
| <FrameState> | ERRor OK INSufficient |
|--------------|---------------------------|

ERRor: an error occurred in the frame.
 OK: frame is valid.
 INSufficient: frame is not completely contained in the acquisition. The acquired part of the frame is valid.

Usage: Query only

BUS:I2S:FRAME<n>:STOP?

Returns the end time of the specified frame.

Suffix:

| | |
|-----|------|
| | 1..4 |
| <n> | * |

Return values:

| | | |
|------------|------------|--|
| <StopTime> | Range: | depends on sample rate, record length, and time base |
| | Increment: | depends on the time base |

Usage: Query only

BUS:I2S:FRAME<n>:TDM<o>:STATe?

Returns the state of the specified TDM channel and frame.

Suffix:

| | |
|-----|------|
| | 1..4 |
| <n> | * |
| <o> | 1..8 |

Return values:

| | |
|---------|--|
| <State> | ERRor OK INSufficient |
| | ERRor: an error occurred in the frame. |
| | OK: frame is valid. |
| | INSufficient: frame is not completely contained in the acquisition. The acquired part of the frame is valid. |

Usage: Query only

BUS:I2S:FRAMe<n>:TDM<o>:VALue?

Returns the data word of the specified frame on the selected TDM channel.

Suffix:

| | |
|-----|-------------------------|
| | 1..4 |
| <n> | * |
| <o> | 1..8 |
| | Selects the TDM channel |

Return values:

| | |
|---------|----------------------|
| <Value> | Signed decimal value |
|---------|----------------------|

Usage: Query only

16.11.8 MIL-1553 (Option R&S RTM-K6)

- [MIL-1553 Configuration](#).....649
- [MIL-1553 Trigger](#).....652
- [MIL-1553 Decode Results](#).....659
- [MIL-1553 Search](#).....666

16.11.8.1 MIL-1553 Configuration

| | |
|---|-----|
| BUS:MILStd:IMGTime:INFinite | 650 |
| BUS:MILStd:IMGTime:MAXimum | 650 |
| BUS:MILStd:IMGTime:MINimum | 650 |
| BUS:MILStd:POLarity | 650 |
| BUS:MILStd:RESPonsetime:INFinite | 650 |
| BUS:MILStd:RESPonsetime:MAXimum | 651 |
| BUS:MILStd:RESPonsetime:MINimum | 651 |
| BUS:MILStd:SOURce | 651 |
| BUS:MILStd:THReshold:HIGH | 651 |
| BUS:MILStd:THReshold:LOW | 651 |

BUS:MILStd:IMGTime:INFinite <MaximumInfinite>

Set the maximum inter message gap time to infinity.

Suffix:

 1..4

Parameters:

<MaximumInfinite> ON | OFF
*RST: ON

BUS:MILStd:IMGTime:MAXimum <MaximumTime>

Sets the maximum inter message gap time.

Suffix:

 1..4

Parameters:

<MaximumTime>

BUS:MILStd:IMGTime:MINimum <MinimumTime>

Sets the minimum inter message gap time.

Suffix:

 1..4

Parameters:

<MinimumTime>

BUS:MILStd:POLarity <Polarity>

Sets the polarity of the bus.

Suffix:

 1..4

Parameters:

<Polarity> POSitive | NEGative
*RST: POS

BUS:MILStd:RESPonsetime:INFinite <MaximumInfinite>**Suffix:**

 1..4

Parameters:

<MaximumInfinite> ON | OFF
*RST: ON

BUS:MILStd:RESPonsetime:MAXimum <MaximumTime>

Sets a value for the maximum response time.

Suffix:

 1..2

Parameters:

<MaximumTime>

BUS:MILStd:RESPonsetime:MINimum <MinimumTime>

Sets the minimum response time.

Suffix:

 1..4

Parameters:

<MinimumTime>

BUS:MILStd:SOURce <Source>

Sets the channel for the signal source for the MIL-STD-1553 analysis.

Suffix:

 1..4

Parameters:

<Source> CH1 | CH2 | CH3 | CH4
*RST: CH1

BUS:MILStd:THReshold:HIGH <UpperLevel>

Sets the upper threshold level of the signal.

Suffix:

 1..4

Parameters:

<UpperLevel>

BUS:MILStd:THReshold:LOW <LowerLevel>

Sets the lower threshold level of the signal.

Suffix:

 1..4

Parameters:

<LowerLevel>

16.11.8.2 MIL-1553 Trigger

| | |
|---|-----|
| TRIGger:A:MILStd:COMManD:TYPE..... | 652 |
| TRIGger:A:MILStd:DATA:CONDition..... | 653 |
| TRIGger:A:MILStd:DATA:MAXimum..... | 653 |
| TRIGger:A:MILStd:DATA:MINimum..... | 653 |
| TRIGger:A:MILStd:DATA:OFFSet..... | 653 |
| TRIGger:A:MILStd:DATA:OFFSet:CONDition..... | 653 |
| TRIGger:A:MILStd:DATA:WORDs..... | 653 |
| TRIGger:A:MILStd:ERRor:MANChester..... | 653 |
| TRIGger:A:MILStd:ERRor:PARity..... | 654 |
| TRIGger:A:MILStd:ERRor:SYNC..... | 654 |
| TRIGger:A:MILStd:ERRor:TIMeout..... | 654 |
| TRIGger:A:MILStd:FRAMe..... | 654 |
| TRIGger:A:MILStd:MCODE:CODE..... | 654 |
| TRIGger:A:MILStd:MCODE:VALue..... | 655 |
| TRIGger:A:MILStd:MODE..... | 655 |
| TRIGger:A:MILStd:RTADdress:CONDition..... | 655 |
| TRIGger:A:MILStd:RTADdress:MAXimum..... | 655 |
| TRIGger:A:MILStd:RTADdress:MINimum..... | 655 |
| TRIGger:A:MILStd:SADdress:CONDition..... | 656 |
| TRIGger:A:MILStd:SADdress:MAXimum..... | 656 |
| TRIGger:A:MILStd:SADdress:MCADdress..... | 656 |
| TRIGger:A:MILStd:SADdress:MINimum..... | 656 |
| TRIGger:A:MILStd:STATus:BCReceivEd..... | 656 |
| TRIGger:A:MILStd:STATus:BUSY..... | 656 |
| TRIGger:A:MILStd:STATus:DBCaccept..... | 657 |
| TRIGger:A:MILStd:STATus:INSTrument..... | 657 |
| TRIGger:A:MILStd:STATus:MERRor..... | 657 |
| TRIGger:A:MILStd:STATus:SREQuest..... | 657 |
| TRIGger:A:MILStd:STATus:SUBSsystem..... | 657 |
| TRIGger:A:MILStd:STATus:TERMinal..... | 657 |
| TRIGger:A:MILStd:SYNC..... | 658 |
| TRIGger:A:MILStd:TRMode..... | 658 |
| TRIGger:A:MILStd:TTYPE..... | 658 |
| TRIGger:A:MILStd:TYPE..... | 658 |
| TRIGger:A:MILStd:WCOunt:CONDition..... | 658 |
| TRIGger:A:MILStd:WCOunt:MAXimum..... | 659 |
| TRIGger:A:MILStd:WCOunt:MINimum..... | 659 |
| TRIGger:A:MILStd:WORD..... | 659 |

TRIGger:A:MILStd:COMManD:TYPE <CommandType>

Selects the command type.

Parameters:

<CommandType> AWORD | MCODE
 *RST: AWOR

TRIGger:A:MILStd:DATA:CONDition <Compare>

For a data word, sets the triggering condition for the comparison of the decoded value to the defined range.

Parameters:

<Compare> EQUal | NEQUal | GTHan | GEQUal | LEQUal | LTHan | WITHin |
 OUTSide
*RST: OFF

TRIGger:A:MILStd:DATA:MAXimum <DataMinimum>

For a data word, sets the maximum data value.

Parameters:

<DataMinimum> 01X-string

TRIGger:A:MILStd:DATA:MINimum <DataMinimum>

For a data word, sets the minimum data value.

Parameters:

<DataMinimum> 01X-string

TRIGger:A:MILStd:DATA:OFFSet <DataOffset>

For a data word sets the word offset to be triggered on.

Parameters:

<DataOffset> *RST: 0

TRIGger:A:MILStd:DATA:OFFSet:CONDition <DataOffset>

For a data offset, sets the triggering condition for the comparison of the decoded value to the defined range.

Parameters:

<DataOffset> EQUal | NEQUal | GTHan | GEQUal | LEQUal | LTHan
*RST: 0

TRIGger:A:MILStd:DATA:WORDs <DataWords>

For a data word sets the number of words to be triggered on.

Parameters:

<DataWords> *RST: 1

TRIGger:A:MILStd:ERRor:MANChester <ErrorEnable>

Enables/disables triggering if there is an error in the Manchester coding of the signal.

Parameters:

<ErrorEnable> ON | OFF
 *RST: ON

TRIGger:A:MILStd:ERRor:PARity <ErrorEnable>

Enables/disables triggering when the parity is even.

Parameters:

<ErrorEnable> ON | OFF
 *RST: ON

TRIGger:A:MILStd:ERRor:SYNC <ErrorEnable>

Enables/disables triggering when a sync impulse doesn't fulfil the technical requirements or when the transmission is not valid.

Parameters:

<ErrorEnable> ON | OFF
 *RST: ON

TRIGger:A:MILStd:ERRor:TIMEout <ErrorEnable>

Enables/ disables triggering when the timeout is out of the set range.

Parameters:

<ErrorEnable> ON | OFF
 *RST: ON

TRIGger:A:MILStd:FRAME <Frame>**Parameters:**

<Frame> COMMANd | STATus | DATA | ALL
 *RST: CST

TRIGger:A:MILStd:MCODe:CODE <ModeCode>

Sets a function for the mode code to be triggered on.

Parameters:

<ModeCode> DBControl | TSYNchronize | TSTatus | ISELftest | TSHUTDOWN |
 OTSHUTDOWN | ITERminal | OITerminal | RESet | VECTor |
 RSYNchronize | TLASTcmmand | BITWord | STSHUTDOWN |
 OSTShutdown | ANY

DBControl: dynamic bus control.
 TSYNchronize: synchronize without data.
 TSTatus: transmit status word.
 ISELftest: initiate self-test.

TSHUTDOWN: transmitter shutdown.
 OTSHUTDOWN: override transmitter shutdown.
 ITERMINAL: inhibit terminal flag bit.
 OITERMINAL: override inhibit terminal flag bit.
 RESET: reset remote terminal.
 VECTOR: transmit vector word.
 RSYNCHRONIZE: synchronize with data.
 TLASTCOMMAND: transmit last command word.
 BITWORD: transmit BIT word.
 STSHUTDOWN: selected transmitter shutdown.
 OSTSHUTDOWN: override selected transmitter shutdown.
 *RST: ANY

TRIGGER:A:MILStd:MCODE:VALUE <ModeCode>

Sets the value of the mode code to be triggered on.

Parameters:

<ModeCode>

TRIGGER:A:MILStd:MODE <TriggerMode>

Parameters:

<TriggerMode> SYNCHRONIZATION | FRAME | ERROR | COMMAND | STATUS |
 DATA | CDATA

*RST: SYNC

TRIGGER:A:MILStd:RTADDRESS:CONDITION <Compare>

For the RT address, sets the triggering condition for the comparison of the decoded value to the defined range.

Parameters:

<Compare> EQUAL | NEQUAL | GTHAN | GEQUAL | LEQUAL | LTHAN | WITHIN |
 OUTSIDE

*RST: OFF

TRIGGER:A:MILStd:RTADDRESS:MAXIMUM <AddressMaximum>

Sets the maximum RT address.

Parameters:

<AddressMaximum> 01X-string

TRIGGER:A:MILStd:RTADDRESS:MINIMUM <AddressMinimum>

Sets the minimum RT address.

Parameters:

<AddressMinimum> 01X-string

TRIGger:A:MILStd:SADdress:CONDition <Compare>

For the subaddress, sets the triggering condition for the comparison of the decoded value to the defined range.

Parameters:

<Compare> EQUal | NEQual | GTHan | GEQual | LEQual | LTHan | WITHin |
 OUTSide

*RST: OFF

TRIGger:A:MILStd:SADdress:MAXimum <AddressMaximum>

Sets the maximum subaddress.

Parameters:

<AddressMaximum> 01X-string

TRIGger:A:MILStd:SADdress:MCAddress <ModeCodeAddress>

Triggers on the value of the subaddress, if `TRIGger:A:MILStd:COMManD:TYPE` is set to `MCODE`.

Parameters:

<ModeCodeAddress> A0 | A31 | EITHer

*RST: EITH

TRIGger:A:MILStd:SADdress:MINimum <AddressMinimum>

Sets the minimum subaddress.

Parameters:

<AddressMinimum> 01X-string

TRIGger:A:MILStd:STATus:BCReceived <StatusBit>

Triggers on the state of the broadcast command received bit of the status word.

Parameters:

<StatusBit> 0 | 1 | X

*RST: X

TRIGger:A:MILStd:STATus:BUSY <StatusBit>

Triggers on the state of the busy bit of the status word.

Parameters:

<StatusBit> 0 | 1 | X
 *RST: X

TRIGger:A:MILStd:STATus:DBCaccept <StatusBit>

Triggers on the state of the dynamic bus control accept bit of the status word.

Parameters:

<StatusBit> 0 | 1 | X
 *RST: X

TRIGger:A:MILStd:STATus:INSTrument <StatusBit>

Triggers on the state of the instrumentation bit of the status word.

Parameters:

<StatusBit> 0 | 1 | X
 *RST: X

TRIGger:A:MILStd:STATus:MERRor <StatusBit>

Triggers on the state of the message error bit of the status word.

Parameters:

<StatusBit> 0 | 1 | X
 *RST: X

TRIGger:A:MILStd:STATus:SREQuest <StatusBit>

Triggers on the state of the service request bit of the status word.

Parameters:

<StatusBit> 0 | 1 | X
 *RST: X

TRIGger:A:MILStd:STATus:SUBSystem <StatusBit>

Triggers on the state of the subsystem flag bit of the status word.

Parameters:

<StatusBit> 0 | 1 | X
 *RST: X

TRIGger:A:MILStd:STATus:TERMinal <StatusBit>

Triggers on the state of the terminal flag bit of the status word.

Parameters:

<StatusBit> 0 | 1 | X
 *RST: X

TRIGger:A:MILStd:SYNC <SyncMode>

Triggers on a sync impulse. You can select to trigger on comando/status, on data or on either syncs.

Parameters:

<SyncMode> CStatus | DATA | EITHER
 *RST: CST

TRIGger:A:MILStd:TRMode <DataDirection>

Triggers on a transmission mode.

Parameters:

<DataDirection> TRANsmit | RECeive | EITHer
 *RST: EITH

TRIGger:A:MILStd:TTPe <TransmissionType>

Sets the transmission type to be triggered on.

Parameters:

<TransmissionType> BCRT | RTBC | RTRT | MCData
 BCRT: bus controller to remote terminal transmission.
 RTBC: remote terminal to bus controller transmission.
 RTRT: remote terminal to remote terminal transmission.
 MCData: mode code data.
 *RST: BCRT

TRIGger:A:MILStd:TYPE <TriggerMode>

Selects the type of trigger.

Parameters:

<TriggerMode> SYNChronization | FRAME | ERRor | COMMand | STATus |
 DATA
 *RST: SYNC

TRIGger:A:MILStd:WCOunt:CONDition <Compare>**Parameters:**

<Compare> EQUal | NEQual | GTHan | GEQual | LEQual | LTHan | WITHin |
 OUTSide
 *RST: OFF

TRIGger:A:MILStd:WCOunt:MAXimum <WordCountMaximum>

Parameters:

<WordCountMaximum>

TRIGger:A:MILStd:WCOunt:MINimum <WordCountMinimum>

Parameters:

<WordCountMinimum>

TRIGger:A:MILStd:WORD <WordTyoe>

Selects the word type to be triggered on.

Parameters:

<WordTyoe> COMMand | STATus | DATA | ALL
 *RST: CST

16.11.8.3 MIL-1553 Decode Results

| | |
|---|-----|
| BUS:MILStd:WCOunt?..... | 659 |
| BUS:MILStd:WORD<n>:COMMand:MCODE:CODE?..... | 660 |
| BUS:MILStd:WORD<n>:COMMand:MCODE:VALue?..... | 660 |
| BUS:MILStd:WORD<n>:COMMand:RTADdress?..... | 661 |
| BUS:MILStd:WORD<n>:COMMand:SADdress?..... | 661 |
| BUS:MILStd:WORD<n>:COMMand:WCOunt?..... | 661 |
| BUS:MILStd:WORD<n>:DATA?..... | 661 |
| BUS:MILStd:WORD<n>:IMGTime?..... | 662 |
| BUS:MILStd:WORD<n>:PARity?..... | 662 |
| BUS:MILStd:WORD<n>:RTIME?..... | 662 |
| BUS:MILStd:WORD<n>:STARt?..... | 662 |
| BUS:MILStd:WORD<n>:STATus?..... | 663 |
| BUS:MILStd:WORD<n>:STATus:BCReceivEd?..... | 663 |
| BUS:MILStd:WORD<n>:STATus:BUSY?..... | 663 |
| BUS:MILStd:WORD<n>:STATus:DBCaccept?..... | 663 |
| BUS:MILStd:WORD<n>:STATus:INSTrument?..... | 664 |
| BUS:MILStd:WORD<n>:STATus:MERRor?..... | 664 |
| BUS:MILStd:WORD<n>:STATus:RTADdress?..... | 664 |
| BUS:MILStd:WORD<n>:STATus:SREQuest?..... | 664 |
| BUS:MILStd:WORD<n>:STATus:SUBSystem?..... | 665 |
| BUS:MILStd:WORD<n>:STATus:TERMinal?..... | 665 |
| BUS:MILStd:WORD<n>:STOP?..... | 665 |
| BUS:MILStd:WORD<n>:TRMode?..... | 665 |
| BUS:MILStd:WORD<n>:TYPE?..... | 666 |

BUS:MILStd:WCOunt?

Returns the number of received words.

Suffix:
 1..4

Return values:
 <WordCount>

Usage: Query only

BUS:MILStd:WORD<n>:COMMand:MCODE:CODE?

For the specified command word, returns the type of mode code.

Suffix:
 1..4
 <n> *

Return values:
 <ModeCode> DBControl | TSYNchronize | TSTatus | ISELftest | TSHUTDOWN | OTSHUTDOWN | ITERminal | OITerminal | RESet | VECTor | RSYNchronize | TLAScmmand | BITWord | STSHUTDOWN | OSTShutdown

DBControl: dynamic bus control.
 TSYNchronize: synchronize without data.
 TSTatus: transmit status word.
 ISELftest: initiate self-test.
 TSHUTDOWN: transmitter shutdown.
 OTSHUTDOWN: override transmitter shutdown.
 ITERminal: inhibit terminal flag bit.
 OITerminal: override inhibit terminal flag bit.
 RESet: reset remote terminal.
 VECTor: transmit vector word.
 RSYNchronize: synchronize with data.
 TLAScmmand: transmit last command word.
 BITWord: transmit BIT word.
 STSHUTDOWN: selected transmitter shutdown.
 OSTShutdown: override selected transmitter shutdown.

*RST: ANY

Usage: Query only

BUS:MILStd:WORD<n>:COMMand:MCODE:VALue?

For the specified command word, returns the value of the mode code.

Suffix:
 1..4
 <n> *

Return values:
 <ModeCodeValue>

Usage: Query only

BUS:MILStd:WORD<n>:COMMand:RTAddress?

Returns the RT address of the specified word.

Suffix:

 1..4

<n> *

Return values:

<RTAddress>

Usage: Query only

BUS:MILStd:WORD<n>:COMMand:SADdress?

For a command word, returns the subaddress of the specified word.

Suffix:

 1..4

<n> *

Return values:

<SubAddress>

Usage: Query only

BUS:MILStd:WORD<n>:COMMand:WCOunt?

For a command word, returns the word count.

Suffix:

 1..4

<n> *

Return values:

<WordCount>

Usage: Query only

BUS:MILStd:WORD<n>:DATA?

Returns the value of the specified data word.

Suffix:

 1..4

<n> *

Return values:

<DataValue>

Usage: Query only

BUS:MILStd:WORD<n>:IMGTime?

Returns the intermessage gap time of the specified word.

Suffix:

 1..4

<n> *

Return values:

<InterMessageGapTime>

Usage: Query only

BUS:MILStd:WORD<n>:PARity?

Returns the parity of the specified word.

Suffix:

 1..4

<n> *

Return values:

<ParityValue>

Usage: Query only

BUS:MILStd:WORD<n>:RTIME?

Return the response time of the specified word.

Suffix:

 1..4

<n> *

Return values:

<ResponseTime>

Usage: Query only

BUS:MILStd:WORD<n>:START?

Returns the start time of the specified word.

Suffix:

 1..4

<n> *

Return values:

<StartTime>

Usage: Query only

BUS:MILStd:WORD<n>:STATus?

For a status word returns the value and if there are errors.

Suffix:

 1..4

<n> *

Parameters:

<WordState> OK | INSufficient | PERRor | MERRor | TERRor | SERRor

Usage: Query only

BUS:MILStd:WORD<n>:STATus:BCReceived?

Returns the state of the broadcast command received bit of the specified status word.

Suffix:

 1..4

<n> *

Return values:

<BitState>

Usage: Query only

BUS:MILStd:WORD<n>:STATus:BUSY?

Returns the state of the busy bit of the specified status word.

Suffix:

 1..4

<n> *

Return values:

<BitState>

Usage: Query only

BUS:MILStd:WORD<n>:STATus:DBCaccept?

Returns the state of the dynamic bus control bit of the specified status word.

Suffix:

 1..4

<n> *

Return values:

<BitState>

Usage: Query only

BUS:MILStd:WORD<n>:STATus:INSTrument?

Returns the state of the instrumentation bit of the specified status word.

Suffix:

 1..4

<n> *

Return values:

<BitState>

Usage: Query only

BUS:MILStd:WORD<n>:STATus:MERRor?

Returns the state of the message error bit of the specified status word.

Suffix:

 1..4

<n> *

Return values:

<BitState>

Usage: Query only

BUS:MILStd:WORD<n>:STATus:RTADdress?

Returns the RT address of the specified status word.

Suffix:

 1..4

<n> *

Return values:

<RTAddress>

Usage: Query only

BUS:MILStd:WORD<n>:STATus:SREQuest?

Returns the state of the service request bit of the specified word.

Suffix:

 1..4

<n> *

Return values:

<BitState>

Usage: Query only

BUS:MILStd:WORD<n>:STATus:SUBSystem?

Returns the state of the subsystem bit of the specified status word.

Suffix:

 1..4

<n> *

Return values:

<BitState>

Usage: Query only

BUS:MILStd:WORD<n>:STATus:TERMinal?

Returns the state of the terminal flag bit of the specified status word.

Suffix:

 1..4

<n> *

Return values:

<BitState>

Usage: Query only

BUS:MILStd:WORD<n>:STOP?

Returns the stop time of the word of the specified word.

Suffix:

 1..4

<n> *

Return values:

<StopTime>

Usage: Query only

BUS:MILStd:WORD<n>:TRMode?

Returns the transmission direction of the specified word.

Suffix:

 1..4

<n> *

Return values:

<DataDirection> TRANsmit | RECEive

Usage: Query only

BUS:MILStd:WORD<n>:TYPE?

Returns the type of word of the specified word.

Suffix:

 1..4

<n> *

Return values:

<WordType> COMMand | STATus | DATA | CMCode

Usage: Query only

16.11.8.4 MIL-1553 Search

| | |
|---|-----|
| SEARCh:PROTocol:MILStd:CONDition..... | 666 |
| SEARCh:PROTocol:MILStd:DATA:CONDition..... | 667 |
| SEARCh:PROTocol:MILStd:DATA:MAXimum..... | 667 |
| SEARCh:PROTocol:MILStd:DATA:MINimum..... | 667 |
| SEARCh:PROTocol:MILStd:DATA:OFFSet..... | 667 |
| SEARCh:PROTocol:MILStd:DATA:WORDs..... | 667 |
| SEARCh:PROTocol:MILStd:ERRor..... | 667 |
| SEARCh:PROTocol:MILStd:MCODE..... | 668 |
| SEARCh:PROTocol:MILStd:RTADdress:CONDition..... | 668 |
| SEARCh:PROTocol:MILStd:RTADdress:MAXimum..... | 668 |
| SEARCh:PROTocol:MILStd:RTADdress:MINimum..... | 668 |
| SEARCh:PROTocol:MILStd:SADdress:CONDition..... | 668 |
| SEARCh:PROTocol:MILStd:SADdress:MAXimum..... | 668 |
| SEARCh:PROTocol:MILStd:SADdress:MCADdress..... | 669 |
| SEARCh:PROTocol:MILStd:SADdress:MINimum..... | 669 |
| SEARCh:PROTocol:MILStd:STATus:BCReceivEd..... | 669 |
| SEARCh:PROTocol:MILStd:STATus:BUSY..... | 669 |
| SEARCh:PROTocol:MILStd:STATus:DBCaccept..... | 669 |
| SEARCh:PROTocol:MILStd:STATus:INSTrument..... | 669 |
| SEARCh:PROTocol:MILStd:STATus:MERRor..... | 670 |
| SEARCh:PROTocol:MILStd:STATus:SREQuest..... | 670 |
| SEARCh:PROTocol:MILStd:STATus:SUBSystem..... | 670 |
| SEARCh:PROTocol:MILStd:STATus:TERMinal..... | 670 |
| SEARCh:PROTocol:MILStd:TRMode..... | 670 |
| SEARCh:PROTocol:MILStd:TTYPe..... | 670 |
| SEARCh:PROTocol:MILStd:WCOunt:CONDition..... | 671 |
| SEARCh:PROTocol:MILStd:WCOunt:MAXimum..... | 671 |
| SEARCh:PROTocol:MILStd:WCOunt:MINimum..... | 671 |
| SEARCh:PROTocol:MILStd:WStart..... | 671 |

SEARCh:PROTocol:MILStd:CONDition <SearchCondition>

Selects the condition to be searched for.

Parameters:

<SearchCondition> WStart | ERRor | STATus | DATA | COMMand | MCODE |
CDATA
*RST: WST

SEARCH:PROTOCOL:MILStd:DATA:CONDition <Comparison>

For a data word, searches for a comparison condition.

Parameters:

<Comparison> OFF | EQUal | NEQual | GTHan | GEQual | LEQual | LTHan |
WITHin | OUTSide
*RST: OFF

SEARCH:PROTOCOL:MILStd:DATA:MAXimum <DataMaximum>

For a data word, searches for a maximum value.

Parameters:

<DataMaximum> 01X-string

SEARCH:PROTOCOL:MILStd:DATA:MINimum <DataMinimum>

For a data word, searches for a minimum value.

Parameters:

<DataMinimum> 01X-string

SEARCH:PROTOCOL:MILStd:DATA:OFFSet <DataOffset>

For a data word, searches for a data offset.

Parameters:

<DataOffset> *RST: 0

SEARCH:PROTOCOL:MILStd:DATA:WORDs <DataWords>

For a data word, searches for a number of words.

Parameters:

<DataWords> *RST: 1

SEARCH:PROTOCOL:MILStd:ERRor <ErrorType>

Selects the error type to be searched for.

Parameters:

<ErrorType> SYNChronization | PARity | TIMEout | MANChester | ANY

SEARCh:PROTOcol:MILStd:MCODE <ModeCode>

Searches for a mode code type.

Parameters:

<ModeCode> DBControl | TSYNchronize | TStatus | ISELftest | TSHUTDOWN |
OTSHUTDOWN | ITERminal | OITerminal | RESet | VECTor |
RSYNchronize | TLAScmmand | BITWord | STSHUTDOWN |
OSTSHUTDOWN | ANY
*RST: ANY

SEARCh:PROTOcol:MILStd:RTAddress:CONDition <Comparison>

For an RT address, searches for a comparison condition.

Parameters:

<Comparison> OFF | EQUal | NEQual | GTHan | GEQual | LEQual | LTHan |
WITHin | OUTSide
*RST: OFF

SEARCh:PROTOcol:MILStd:RTAddress:MAXimum <AddressMaximum>

For an RT address, searches for the maximum address.

Parameters:

<AddressMaximum> 01X-string

SEARCh:PROTOcol:MILStd:RTAddress:MINimum <AddressMinimum>

For an RT address, searches for the minimum address.

Parameters:

<AddressMinimum> 01X-string

SEARCh:PROTOcol:MILStd:SADDRESS:CONDition <Comparison>

For a subaddress, searches for a comparison condition.

Parameters:

<Comparison> OFF | EQUal | NEQual | GTHan | GEQual | LEQual | LTHan |
WITHin | OUTSide
*RST: OFF

SEARCh:PROTOcol:MILStd:SADDRESS:MAXimum <AddressMaximum>

For a subaddress, searches for the maximum address.

Parameters:

<AddressMaximum> 01X-string

SEARCh:PROTOcol:MILStd:SADdRes:MCADdRes <ModeCodeAddress>

Searches for a mode code address.

Parameters:

<ModeCodeAddress> A0 | A31 | EITHer
*RST: EITH

SEARCh:PROTOcol:MILStd:SADdRes:MINimum <AddressMinimum>

For a subaddress, searches for the minimum address.

Parameters:

<AddressMinimum> 01X-string

SEARCh:PROTOcol:MILStd:STATus:BCReceivEd <StatusBit>

Searches for a broadcast received bit of a status word.

Parameters:

<StatusBit> 0 | 1 | X
*RST: X

SEARCh:PROTOcol:MILStd:STATus:BUSY <StatusBit>

Searches for a busy bit of a status word.

Parameters:

<StatusBit> 0 | 1 | X
*RST: X

SEARCh:PROTOcol:MILStd:STATus:DBCaccept <StatusBit>

Searches for a dynamic bus control accept bit of a status word.

Parameters:

<StatusBit> 0 | 1 | X
*RST: X

SEARCh:PROTOcol:MILStd:STATus:INSTrument <StatusBit>

Searches for an instrument bit of a status word.

Parameters:

<StatusBit> 0 | 1 | X
*RST: X

SEARCh:PROTOcol:MILStd:STATus:MERRor <StatusBit>

Searches for a message error bit of a status word.

Parameters:

<StatusBit> 0 | 1 | X
*RST: X

SEARCh:PROTOcol:MILStd:STATus:SREQuest <StatusBit>

Searches for a service request bit of a status word.

Parameters:

<StatusBit> 0 | 1 | X
*RST: X

SEARCh:PROTOcol:MILStd:STATus:SUBSystem <StatusBit>

Searches for a subsystem bit of a status word.

Parameters:

<StatusBit> 0 | 1 | X
*RST: X

SEARCh:PROTOcol:MILStd:STATus:TERMinal <StatusBit>

Searches for a terminal bit of a status word.

Parameters:

<StatusBit> 0 | 1 | X
*RST: X

SEARCh:PROTOcol:MILStd:TRMode <DataDirection>

Selects the transmission mode to be searched for.

Parameters:

<DataDirection> TRANsmit | RECeive | EITHer
*RST: EITH

SEARCh:PROTOcol:MILStd:TTYPE <TransmissionType>

Selects the transmission type to be searched for.

Parameters:

<TransmissionType> BCRT | RTBC | RTRT | MCDData
BCRT: bus controller to remote terminal transmission
RTBC: remote terminal to bus controller transmission
RTRT: remote terminal to remote terminal transmission

MCDATA: mde code with data

*RST: BCRT

SEARCh:PROTOcol:MILStd:WCOunt:CONDition <Compare>

Searches for a comparison condition of the word count.

Parameters:

<Compare> OFF | EQUal | NEQual | GTHan | GEQual | LEQual | LTHan |
WITHin | OUTSide

*RST: OFF

SEARCh:PROTOcol:MILStd:WCOunt:MAXimum <WordCountMaximum>

Searches for the maximum word count.

Parameters:

<WordCountMaximum>

SEARCh:PROTOcol:MILStd:WCOunt:MINimum <WordCountMinimum>

Searches for the minimum word count.

Parameters:

<WordCountMinimum>

SEARCh:PROTOcol:MILStd:WStart <WordStart>

Selects a word start to be searched for.

Parameters:

<WordStart> COMMand | STATus | DATA

*RST: COMM

16.11.9 ARINC 429 (Option R&S RTM-K7)

- [ARINC 429 Configuration](#).....671
- [ARINC 429 Trigger](#).....673
- [ARINC 429 Decode Results](#).....677
- [ARINC 429 Search](#).....680

16.11.9.1 ARINC 429 Configuration

- BUS:ARINC:BRMode..... 672
- BUS:ARINC:BRValue..... 672
- BUS:ARINC:POLarity..... 672

| | |
|----------------------------------|-----|
| BUS:ARINc:SOURce..... | 672 |
| BUS:ARINc:THReshold:HIGH..... | 673 |
| BUS:ARINc:THReshold:LOW..... | 673 |

BUS:ARINc:BRMode <BitRateMode>

Sets the bit rate mode to high speed, low speed or a user defined mode.

If `USER` mode is selected, you can set the bit rate value with `BUS:ARINc:BRValue`.

Suffix:

 1..4

Parameters:

<BitRateMode> HIGH | LOW | USER

BUS:ARINc:BRValue <BitRateValue>

Sets the number of transmitted bits per second.

If you set a value with this command, the mode of `BUS:ARINc:BRMode` will be automatically set to `USER`.

Suffix:

 1..4

Parameters:

<BitRateValue>

BUS:ARINc:POLarity <Polarity>

Sets the wire on which the bus signal is measured.

Suffix:

 1..4

Parameters:

<Polarity> ALEG | BLEG | NORMal | INVerted
*RST: ALEG

BUS:ARINc:SOURce <Source>

Sets the channel for the signal source.

Suffix:

 1..4

Parameters:

<Source> CH1 | CH2 | CH3 | CH4
*RST: CH1

BUS:ARINc:THReshold:HIGH <ThresholdHigh>

Sets the high threshold level of the signal.

Suffix:

 1..4

Parameters:

<ThresholdHigh>

BUS:ARINc:THReshold:LOW <ThresholdLow>

Sets the low threshold level of the signal.

Suffix:

 1..4

Parameters:

<ThresholdLow>

16.11.9.2 ARINC 429 Trigger

| | |
|--------------------------------------|-----|
| TRIGger:A:ARINc:DATA:CONDition..... | 673 |
| TRIGger:A:ARINc:DATA:MAXimum..... | 674 |
| TRIGger:A:ARINc:DATA:MINimum..... | 674 |
| TRIGger:A:ARINc:DATA:OFFSet..... | 674 |
| TRIGger:A:ARINc:DATA:SIZE..... | 674 |
| TRIGger:A:ARINc:ERRor:CODing..... | 674 |
| TRIGger:A:ARINc:ERRor:GAP..... | 675 |
| TRIGger:A:ARINc:ERRor:PARity..... | 675 |
| TRIGger:A:ARINc:FORMat..... | 675 |
| TRIGger:A:ARINc:LABel:CONDition..... | 675 |
| TRIGger:A:ARINc:LABel:MAXimum..... | 676 |
| TRIGger:A:ARINc:LABel:MINimum..... | 676 |
| TRIGger:A:ARINc:SDI..... | 676 |
| TRIGger:A:ARINc:SSM..... | 676 |
| TRIGger:A:ARINc:TTIME:CONDition..... | 676 |
| TRIGger:A:ARINc:TTIME:MAXimum..... | 676 |
| TRIGger:A:ARINc:TTIME:MINimum..... | 676 |
| TRIGger:A:ARINc:TYPE..... | 677 |
| TRIGger:A:ARINc:WORD:TYPE..... | 677 |

TRIGger:A:ARINc:DATA:CONDition <Compare>

Define the operators for comparison of the decoded data condition with the specified data.

Parameters:

<Compare> EQUal | NEQUal | GTHan | GEQUal | LEQUal | LTHan | WITHin |
 OUTSide

INRange: in range

OORange: out of range

EQUal | NEQual | GTHan | LTHan

Equal, not equal, greater than, less than. These conditions require one data word to be set with `TRIGger:A:ARINc:DATA:MINimum`.

INRange | OORange

In range / Out of range: Set the minimum and maximum value of the range with `TRIGger:A:ARINc:DATA:MINimum` and `TRIGger:A:ARINc:DATA:MAXimum`.

TRIGger:A:ARINc:DATA:MAXimum <DataMaximum>

Specifies the maximum value of the data if `TRIGger:A:ARINc:DATA:CONDition` is set to `INRange` or `OORange`.

Parameters:

<DataMaximum> 01X-string

TRIGger:A:ARINc:DATA:MINimum <DataMinimum>

Sets the minimum condition for the data.

Parameters:

<DataMinimum> 01X-string

TRIGger:A:ARINc:DATA:OFFSet <DataOffset>

Sets a data offset.

Parameters:

<DataOffset>

TRIGger:A:ARINc:DATA:SIZE <DataSize>

Sets the data size.

Parameters:

<DataSize>

TRIGger:A:ARINc:ERRor:CODing <ErrorEnable>

Enables triggering when a coding error occurs.

Parameters:

<ErrorEnable> ON | OFF

*RST: ON

TRIGger:A:ARINc:ERRor:GAP <ErrorEnable>

Enables triggering when a gap error occurs.

Parameters:

<ErrorEnable> ON | OFF
*RST: ON

TRIGger:A:ARINc:ERRor:PARity <ErrorEnable>

Enables triggering when a parity error occurs.

Parameters:

<ErrorEnable> ON | OFF
*RST: ON

TRIGger:A:ARINc:FORMat <DataFormat>

Sets the the transmission format to be triggered on.

Parameters:

<DataFormat> DATA | DSSM | DSDI | DSSSm
DSSM: SSM+Data
DSDI: SDI+Data
DSSSm: SSM+Data +SDI

TRIGger:A:ARINc:LABel:CONDition <Compare>

Define the operators for comparison of the decoded label condition with the specified label.

Parameters:

<Compare> EQUal | NEQual | GTHan | GEQual | LEQual | LTHan | WITHin |
OUTSide

INRange: in range

OORange: out of range

EQUal | NEQual | GTHan | LTHan

Equal, not equal, greater than, less than. These conditions require one label to be set with [TRIGger:A:ARINc:LABel:MINimum](#).

INRange | OORange

In range / Out of range: Set the minimum and maximum value of the range with [TRIGger:A:ARINc:LABel:MINimum](#) and [TRIGger:A:ARINc:LABel:MAXimum](#).

TRIGger:A:ARINc:LABel:MAXimum <LabelMaximum>

Specifies the maximum value of the label if **TRIGger:A:ARINc:LABel:CONDition** is set to **INRange** or **OORange**.

Parameters:

<LabelMaximum> 01X-string

TRIGger:A:ARINc:LABel:MINimum <LabelMinimum>

Sets the minimum value of the label to be triggered on.

Parameters:

<LabelMinimum> 01X-string

TRIGger:A:ARINc:SDI <SDIvalue>

Sets the source/destination identifier (SDI) bits to be triggered on.

Parameters:

<SDIvalue> ANY | S00 | S01 | S10 | S11

TRIGger:A:ARINc:SSM <SSMvalue>

Sets the sign/status matrix (SSM) bits to be triggered on.

Parameters:

<SSMvalue> ANY | S00 | S01 | S10 | S11

TRIGger:A:ARINc:TTIME:CONDition <Compare>

Define the operators for comparison of the decoded transmission time condition with the specified data.

Parameters:

<Compare> GTHan | LTHan | WITHin | OUTSide
*RST: GTH

TRIGger:A:ARINc:TTIME:MAXimum <TransmissionTimeMax>

Sets the maximum value of the transmission time.

Parameters:

<TransmissionTimeMax>

TRIGger:A:ARINc:TTIME:MINimum <TransmissionTimeMin>

Sets the minimum value of the transmission time.

Parameters:

<TransmissionTimeMin>

TRIGger:A:ARINc:TYPE <TriggerType>

Selects the type of trigger.

Parameters:

<TriggerType> WORD | ERRor | LABel | LDATa | TTIMe

TRIGger:A:ARINc:WORD:TYPE <WordType>

Sets the word type to be triggered on.

Parameters:

<WordType> START | STOP

16.11.9.3 ARINC 429 Decode Results

| | |
|--|-----|
| BUS:ARINc:WCOunt?..... | 677 |
| BUS:ARINc:DATA:FORMat..... | 677 |
| BUS:ARINc:WORD<n>:DATA[:VALue]?..... | 678 |
| BUS:ARINc:WORD<n>:FORMat?..... | 678 |
| BUS:ARINc:WORD<n>:LABel[:VALue]?..... | 678 |
| BUS:ARINc:WORD<n>:PARity?..... | 678 |
| BUS:ARINc:WORD<n>:PATtern?..... | 679 |
| BUS:ARINc:WORD<n>:SDI?..... | 679 |
| BUS:ARINc:WORD<n>:SSM?..... | 679 |
| BUS:ARINc:WORD<n>:START?..... | 679 |
| BUS:ARINc:WORD<n>:STATus?..... | 680 |
| BUS:ARINc:WORD<n>:STOP?..... | 680 |

BUS:ARINc:WCOunt?

Returns the number of decoded words.

Suffix:

 1..4

Return values:

<WordCount>

Usage:

Query only

BUS:ARINc:DATA:FORMat <StandardDecodeFormat>

Sets the decoding data format for the specified ARINC 429 bus.

Suffix:

 1..4

Parameters:

<StandardDecodeFormat> DATA | DSSM | DSDI | DSSSm

DSSSm: Data + SSM

DSDI: Data + SDI

DSSD: Data + SSM +SDI

BUS:ARINc:WORD<n>:DATA[:VALue]?

Returns the decimal value of the data of the specified word.

Suffix:

 1..4

Return values:

<DataValue>

Usage: Query only

BUS:ARINc:WORD<n>:FORMat?

Returns the format of the sepcified word.

Suffix:

 1..4

Return values:

<DataFormat> DATA | DSSM | DSDI | DSSSm

DSSSm: Data + SSM

DSDI: Data + SDI

DSSD: Data + SSM +SDI

Usage: Query only

BUS:ARINc:WORD<n>:LABel[:VALue]?

Returns the decimal value of the label of the specified word.

Suffix:

 1..4

Return values:

<LabelValue>

Usage: Query only

BUS:ARINc:WORD<n>:PARity?

Returns the parity of the specified word.

Suffix:

 1..4

Return values:

<Parity>

Usage: Query only

BUS:ARINc:WORD<n>:PATteRn?

Returns all 32 bits of a data word as decimal value.

Suffix:

 1..4

Return values:

<PatternValue>

Usage: Query only

BUS:ARINc:WORD<n>:SDI?

Returns the source/destination identifier (SDI) bits of the specified word.

Suffix:

 1..4

Return values:

<SDI>

Usage: Query only

BUS:ARINc:WORD<n>:SSM?

Returns the sign/status matrix(SSM) bits of the specified word.

Suffix:

 1..4

Return values:

<SSM>

Usage: Query only

BUS:ARINc:WORD<n>:StARt?

Returns the start time of the specified word.

Suffix:

 1..4

Return values:

<StartTime>

Usage: Query only

BUS:ARINc:WORD<n>:STATUS?

Returns the overall state of the specified word.

Suffix:

 1..4

Return values:

<WordStatus> OK | INSufficient | INComplete | PRERror | GERRor | CERRor
 PRERror: parity error occurred.
 GERRor: timing gap error occurred.
 CERRor: coding error occurred.

Usage: Query only

BUS:ARINc:WORD<n>:STOP?

Returns the end time of the specified word.

Suffix:

 1..4

Return values:

<StopTime>

Usage: Query only

16.11.9.4 ARINC 429 Search

| | |
|--|-----|
| SEARch:PROTocol:ARINc:CONDition..... | 680 |
| SEARch:PROTocol:ARINc:DATA:CONDition..... | 681 |
| SEARch:PROTocol:ARINc:DATA:MAXimum..... | 681 |
| SEARch:PROTocol:ARINc:DATA:MINimum..... | 682 |
| SEARch:PROTocol:ARINc:DATA:OFFSet..... | 682 |
| SEARch:PROTocol:ARINc:DATA:SIZE..... | 682 |
| SEARch:PROTocol:ARINc:ERRor..... | 682 |
| SEARch:PROTocol:ARINc:FORMat..... | 682 |
| SEARch:PROTocol:ARINc:LAbel:CONDition..... | 683 |
| SEARch:PROTocol:ARINc:LAbel:MAXimum..... | 683 |
| SEARch:PROTocol:ARINc:LAbel:MINimum..... | 683 |
| SEARch:PROTocol:ARINc:SDI..... | 683 |
| SEARch:PROTocol:ARINc:SSM..... | 683 |
| SEARch:PROTocol:ARINc:WORD[:TYPE]..... | 684 |

SEARch:PROTocol:ARINc:CONDition

Sets the event or combination of events to be searched for. Depending on the selected event, further settings are required.

Parameters:

<SearchCondition> WORD | ERRor | LAbel | LDATA

WORD

Search for a word type.

Set the word type with `SEARCH:PROTOCOL:ARINC:WORD[:TYPE]`.

ERROR

Search for errors of one or more error types.

Set the error types with `SEARCH:PROTOCOL:ARINC:ERROR`.

LABEL

Searches for label.

Set the label with `SEARCH:PROTOCOL:ARINC:LABEL:CONDITION`, `SEARCH:PROTOCOL:ARINC:LABEL:MAXIMUM` and `SEARCH:PROTOCOL:ARINC:LABEL:MINIMUM`

LDATA

Searches for label and data.

Set the label with `SEARCH:PROTOCOL:ARINC:LABEL:CONDITION`, `SEARCH:PROTOCOL:ARINC:LABEL:MAXIMUM` and `SEARCH:PROTOCOL:ARINC:LABEL:MINIMUM`

Set the data with `SEARCH:PROTOCOL:ARINC:DATA:CONDITION`, `SEARCH:PROTOCOL:ARINC:DATA:MAXIMUM`, `SEARCH:PROTOCOL:ARINC:DATA:MINIMUM`, `SEARCH:PROTOCOL:ARINC:DATA:OFFSET`, `SEARCH:PROTOCOL:ARINC:DATA:SIZE`, `SEARCH:PROTOCOL:ARINC:SDI` and `SEARCH:PROTOCOL:ARINC:SSM`.

SEARCH:PROTOCOL:ARINC:DATA:CONDITION

Sets the comparison condition for data: If the pattern contains at least one X (don't care), you can trigger on values equal or not equal to the specified value. If the pattern contains only 0 and 1, you can also trigger on a range greater than or lower than the specified value.

The command is relevant if `SEARCH:PROTOCOL:ARINC:CONDITION` is set to `LDATA`.

Parameters:

<DataCondition> EQUAL | NEQUAL | GTHAN | GEQUAL | LEQUAL | LTHAN | WITHIN | OUTSIDE

SEARCH:PROTOCOL:ARINC:DATA:MAXIMUM

Searches for a maximum value of the data if `SEARCH:PROTOCOL:ARINC:DATA:CONDITION` is set to `INRANGE` or `ORANGE`.

The command is relevant if `SEARCH:PROTOCOL:ARINC:CONDITION` is set to `LDATA`.

Parameters:

<DataMaximum> 01X-string

SEARCH:PROTOCOL:ARINC:DATA:MINIMUM

Searches for a minimum value of the data.

The command is relevant if `SEARCH:PROTOCOL:ARINC:CONDITION` is set to `LDATA`.

Parameters:

<DataMinimum> 01X-string

SEARCH:PROTOCOL:ARINC:DATA:OFFSET

Searches for specified data offset.

The command is relevant if `SEARCH:PROTOCOL:ARINC:CONDITION` is set to `LDATA`.

Parameters:

<DataOffset>

SEARCH:PROTOCOL:ARINC:DATA:SIZE

Searches for specified data size.

The command is relevant if `SEARCH:PROTOCOL:ARINC:CONDITION` is set to `LDATA`.

Parameters:

<DataSize>

SEARCH:PROTOCOL:ARINC:ERROR

Searches for an error condition.

The command is relevant if `SEARCH:PROTOCOL:ARINC:CONDITION` is set to `ERROR`.

Parameters:

<ErrorCondition> ANY | PARity | GAP | CODing

SEARCH:PROTOCOL:ARINC:FORMAT

Searches for a data format.

The command is relevant if `SEARCH:PROTOCOL:ARINC:CONDITION` is set to `LDATA`.

Parameters:

<DataFormat> DATA | DSSM | DSDI | DSSSm
 SSMData: SSM+Data
 SDIData: SDI+Data
 SSData: SSM+Data +SDI

SEARCh:PROTOcol:ARINc:LABel:CONDition

Sets the comparison condition for label: If the pattern contains at least one X (don't care), you can trigger on values equal or not equal to the specified value. If the pattern contains only 0 and 1, you can also trigger on a range greater than or lower than the specified value.

The command is relevant if `SEARCh:PROTOcol:ARINc:CONDition` is set to `LABel` or `LDATa`.

Parameters:

<LabelCondition> `EQUal` | `NEQual` | `GTHan` | `GEQual` | `LEQual` | `LTHan` | `WITHin` | `OUTSide`

SEARCh:PROTOcol:ARINc:LABel:MAXimum

Searches for a maximum value of the label if `SEARCh:PROTOcol:ARINc:LABel:CONDition` is set to `INRange` or `OORange`.

The command is relevant if `SEARCh:PROTOcol:ARINc:CONDition` is set to `LABel` or `LDATa`.

Parameters:

<LabelMaximum> `01X-string`

SEARCh:PROTOcol:ARINc:LABel:MINimum

Searches for a minimum value of the label.

The command is relevant if `SEARCh:PROTOcol:ARINc:CONDition` is set to `LABel` or `LDATa`.

Parameters:

<LabelMinimum> `01X-string`

SEARCh:PROTOcol:ARINc:SDI

Searches for the specified source/destination identifier (SDI) bits.

The command is relevant if `SEARCh:PROTOcol:ARINc:CONDition` is set to `LDATa`.

Parameters:

<SDIvalue> `ANY` | `S00` | `S01` | `S10` | `S11`

SEARCh:PROTOcol:ARINc:SSM

Searches for specified sign/status matrix (SSM) bits.

The command is relevant if `SEARCh:PROTOcol:ARINc:CONDition` is set to `LDATa`.

Parameters:

<SSMvalue> `ANY` | `S00` | `S01` | `S10` | `S11`

SEARch:PROTOcol:ARINc:WORD[:TYPE]

Selects the word type to be searched for.

The command is relevant if `SEARch:PROTOcol:ARINc:CONDition` is set to `WORD`.

Parameters:

<WordType> START | STOP

16.12 Power Analysis (Option R&S RTM-K31)

| | |
|------------------------------|-----|
| • General..... | 684 |
| • Probe Adjustment..... | 686 |
| • Report..... | 687 |
| • Consumption..... | 688 |
| • Dynamic ON Resistance..... | 690 |
| • Power Efficiency..... | 691 |
| • Current Harmonic..... | 693 |
| • Inrush Current..... | 699 |
| • Modulation Analysis..... | 700 |
| • Turn On/Off..... | 704 |
| • Quality..... | 705 |
| • Ripple..... | 709 |
| • Slew Rate..... | 714 |
| • S.O.A..... | 720 |
| • Spectrum..... | 728 |
| • Switching..... | 731 |
| • Transient Response..... | 735 |

16.12.1 General

| | |
|-------------------------------|-----|
| POWER:ATYPe..... | 684 |
| POWER:AUToscale..... | 685 |
| POWER:AUToscale:CURRent..... | 685 |
| POWER:AUToscale:VOLTage..... | 685 |
| POWER:ENABLE..... | 685 |
| POWER:RESult:TABLE..... | 685 |
| POWER:SOURce:CURRent<n>..... | 685 |
| POWER:SOURce:VOLTage<n>..... | 686 |
| POWER:STATistics:RESet..... | 686 |
| POWER:STATistics:VISible..... | 686 |

POWER:ATYPe

Sets the type of power analysis measurement.

Parameters:

<AnalysisType> OFF | QUALity | CONSumption | HARMonicsINRushcurrent |
 RIPPLE | SPECTrumSWITChingloss | SLEWrateMODulation |
 DONResistance | EFFiciencySWITChingloss | TURNonoff |
 TRANsient
 *RST: OFF

POWER:AUToscale

Performs an autoset of the voltage and current source scales.

Usage: Event

POWER:AUToscale:CURRent

Performs an autoset of the current source scale.

Usage: Event

POWER:AUToscale:VOLTagE

Performs an autoset of the voltage source scale.

Usage: Event

POWER:ENABle

Enables/disables the power analysis measurements.

Parameters:

<State> ON | OFF
 *RST: OFF

POWER:RESult:TABLE

Displays or hides the result table.

The command is available for harmonic and spectrum power measurements.

Parameters:

<Visible> ON | OFF
 *RST: OFF

POWER:SOURce:CURRent<n>

Sets the channel for the current source. Connect the current probe in flow direction of the current.

Suffix:

<n> 1..2
Only relevant if two current sources are used: 1 = Input, 2 = Output

Parameters:

<CurrentSource> CH1 | CH2 | CH3 | CH4 | RE1 | RE2 | RE3 | RE4

POWer:SOURce:VOLTage<n>

Sets the channel for the voltage source.

Suffix:

<n> 1..4
Only relevant if several voltage sources are used: 1 = In, 2 = Out, 3 and 4 = Out for "Turn ON/OFF time" measurement

Parameters:

<VoltageSource> CH1 | CH2 | CH3 | CH4 | RE1 | RE2 | RE3 | RE4

POWer:STATistics:RESet

Deletes the statistical results for the current measurement or all measurements, respectively, and starts a new statistical evaluation.

Usage: Event

POWer:STATistics:VISible

Shows/ hides the statistical evaluation of the measurement.

Parameters:

<Visible> ON | OFF
*RST: OFF

16.12.2 Probe Adjustment

POWer:DESKew[:EXECute]

Starts the automatic deskew procedure to align the waveforms of all visible channels. It is necessary to deskew if a current and a voltage probe is used in the measurement. Use the R&S RT-ZF20 power deskew fixture to deskew the probes.

Usage: Event

POWer:ZOFFset[:EXECute]

Executes a zero offset for all visible channels.

Usage: Event

16.12.3 Report

| | |
|-------------------------------|-----|
| POWer:REPort:ADD..... | 687 |
| POWer:REPort:DESCRiption..... | 687 |
| POWer:REPort:DUT..... | 687 |
| POWer:REPort:OUTPut..... | 687 |
| POWer:REPort:SITe..... | 687 |
| POWer:REPort:TEMPerature..... | 687 |
| POWer:REPort:USER..... | 688 |

POWer:REPort:ADD

Adds a power report.

Usage: Event

POWer:REPort:DESCRiption

Sets a description that can be shown at the titel page of a report.

Parameters:

<DescriptionString> String parameter

POWer:REPort:DUT

Sets a device under test (DUT) value that can be shown at the titel page of a report.

Parameters:

<DeviceString> String parameter

POWer:REPort:OUTPut

Sets the directory for the output folder, where the reports are stored.

Parameters:

<OutputFolderPath> String parameter

POWer:REPort:SITe

Sets a site value that can be shown at the titel page of a report.

Parameters:

<SiteString> String parameter

POWer:REPort:TEMPerature <Temperature>

Sets a temperature value that can be shown at the titel page of a report.

Parameters:

<Temperature> Range: -273 to 32767
 Increment: 1
 *RST: 20

POWER:REPort:USER

Sets a user value that can be shown at the title page of a report.

Parameters:

<UserString> String parameter

16.12.4 Consumption

| | |
|--|-----|
| POWER:CONSumption:EXECute..... | 688 |
| POWER:CONSumption:REPort:ADD..... | 688 |
| POWER:CONSumption:REStart..... | 688 |
| POWER:CONSumption:RESult:APParent?..... | 688 |
| POWER:CONSumption:RESult:DURation?..... | 689 |
| POWER:CONSumption:RESult:ENERgy?..... | 689 |
| POWER:CONSumption:RESult:PFACTOR?..... | 689 |
| POWER:CONSumption:RESult:PHASe?..... | 689 |
| POWER:CONSumption:RESult:REACTive?..... | 689 |
| POWER:CONSumption:RESult:REALpower?..... | 690 |

POWER:CONSumption:EXECute <State>

Starts the consumption measurement.

Parameters:

<State> ON | OFF

Usage: Event

POWER:CONSumption:REPort:ADD

Adds the result to the report list.

Usage: Event

POWER:CONSumption:REStart

Restarts the consumption measurement.

Usage: Event

POWER:CONSumption:RESult:APParent?

Queries the apparent power, the magnitude of the vector sum of real and reactive power.

Return values:

<ApparentPower>

Usage: Query only

POWER:CONSumption:RESult:DURation?

Queries the duration of the measurement. The result is displayed in seconds.

Return values:

<Duration>

Usage: Query only

POWER:CONSumption:RESult:ENERgy?

Queries the energy.

Return values:

<Energy>

Usage: Query only

POWER:CONSumption:RESult:PFACTOR?

Queries the power factor, a measure of the system efficiency. The value varies between -1 and 1.

Return values:

<PowerFactor>

Usage: Query only

POWER:CONSumption:RESult:PHASe?

Queries the phase angle, the angle between the current and the voltage sine waves.

Return values:

<Phase>

Usage: Query only

POWER:CONSumption:RESult:REACTive?

Queries the reactive power, the power flow that is temporarily stored in a system because of the inductive and capacitive elements.

Return values:

<ReactivePower>

Usage: Query only

POWER:CONSumption:RESult:REALpower?

Queries the real power.

Return values:

<RealPower>

Usage: Query only

16.12.5 Dynamic ON Resistance

| | |
|--|-----|
| POWER:DONResistance:EXECute..... | 690 |
| POWER:DONResistance:GATE<n>:START..... | 690 |
| POWER:DONResistance:GATE<n>:STOP..... | 690 |
| POWER:DONResistance:REPort:ADD..... | 690 |
| POWER:DONResistance:RESult:DONResistance?..... | 691 |

POWER:DONResistance:EXECute

Starts the dynamic on resistance measurement.

Usage: Event

POWER:DONResistance:GATE<n>:START

Sets the start time for the corresponding gate.

Suffix:

<n> 1..2

Return values:

<StartTime>

POWER:DONResistance:GATE<n>:STOP

Sets the stop time for the corresponding gate.

Suffix:

<n> 1..2

Return values:

<StopTime>

POWER:DONResistance:REPort:ADD

Adds the result to the report list.

Usage: Event

POWER:DONResistance:RESult:DONResistance?

Starts the dynamic on resistance measurement.

Return values:

<Value>

Usage: Query only

16.12.6 Power Efficiency

| | |
|---|-----|
| POWER:EFFiciency:EXECute..... | 691 |
| POWER:EFFiciency:REPort:ADD..... | 691 |
| POWER:EFFiciency:RESult:EFFiciency[:ACTual]? | 691 |
| POWER:EFFiciency:RESult:EFFiciency:AVG? | 691 |
| POWER:EFFiciency:RESult:EFFiciency:NPEak? | 691 |
| POWER:EFFiciency:RESult:EFFiciency:PPEak? | 691 |
| POWER:EFFiciency:RESult:EFFiciency:STDDev? | 692 |
| POWER:EFFiciency:RESult:EFFiciency:WFMCCount? | 692 |
| POWER:EFFiciency:RESult:INPut:REALpower[:ACTual]? | 692 |
| POWER:EFFiciency:RESult:INPut:REALpower:AVG? | 692 |
| POWER:EFFiciency:RESult:INPut:REALpower:NPEak? | 692 |
| POWER:EFFiciency:RESult:INPut:REALpower:PPEak? | 692 |
| POWER:EFFiciency:RESult:INPut:REALpower:STDDev? | 692 |
| POWER:EFFiciency:RESult:INPut:REALpower:WFMCCount? | 692 |
| POWER:EFFiciency:RESult:OUTPut:REALpower[:ACTual]? | 692 |
| POWER:EFFiciency:RESult:OUTPut:REALpower:AVG? | 692 |
| POWER:EFFiciency:RESult:OUTPut:REALpower:NPEak? | 692 |
| POWER:EFFiciency:RESult:OUTPut:REALpower:PPEak? | 692 |
| POWER:EFFiciency:RESult:OUTPut:REALpower:STDDev? | 692 |
| POWER:EFFiciency:RESult:OUTPut:REALpower:WFMCCount? | 692 |

POWER:EFFiciency:EXECute

Starts the efficiency measurement.

Usage: Event

POWER:EFFiciency:REPort:ADD

Adds the result to the report list.

Usage: Event

POWER:EFFiciency:RESult:EFFiciency[:ACTual]?**POWER:EFFiciency:RESult:EFFiciency:AVG?****POWER:EFFiciency:RESult:EFFiciency:NPEak?****POWER:EFFiciency:RESult:EFFiciency:PPEak?**

POWER:EFFiciency:RESult:EFFiciency:STDDev?
POWER:EFFiciency:RESult:EFFiciency:WFMCOUNT?

Returns the corresponding statistic result for the efficiency.

- [:ACTual] : current measurement result
- AVG : average of the long-term measurement results
- NPEak : negative peak value of the long-term measurement results
- PPEak : positive peak value of the long-term measurement results
- STDDev : standard deviation of the long-term measurement results
- WFMCOUNT : the number of waveforms used for the displayed results

Return values:

<WaveformCount>

Usage: Query only

POWER:EFFiciency:RESult:INPut:REALpower[:ACTual]?
POWER:EFFiciency:RESult:INPut:REALpower:AVG?
POWER:EFFiciency:RESult:INPut:REALpower:NPEak?
POWER:EFFiciency:RESult:INPut:REALpower:PPEak?
POWER:EFFiciency:RESult:INPut:REALpower:STDDev?
POWER:EFFiciency:RESult:INPut:REALpower:WFMCOUNT?

Returns the corresponding statistic result for the input real power.

- [:ACTual] : current measurement result
- AVG : average of the long-term measurement results
- NPEak : negative peak value of the long-term measurement results
- PPEak : positive peak value of the long-term measurement results
- STDDev : standard deviation of the long-term measurement results
- WFMCOUNT : the number of waveforms used for the displayed results

Return values:

<WaveformCount>

Usage: Query only

POWER:EFFiciency:RESult:OUTPut:REALpower[:ACTual]?
POWER:EFFiciency:RESult:OUTPut:REALpower:AVG?
POWER:EFFiciency:RESult:OUTPut:REALpower:NPEak?
POWER:EFFiciency:RESult:OUTPut:REALpower:PPEak?
POWER:EFFiciency:RESult:OUTPut:REALpower:STDDev?
POWER:EFFiciency:RESult:OUTPut:REALpower:WFMCOUNT?

Returns the corresponding statistic result for the output real power.

- [:ACTual] : current measurement result
- AVG : average of the long-term measurement results
- NPEak : negative peak value of the long-term measurement results

- **PPEak**: positive peak value of the long-term measurement results
- **STDDev**: standard deviation of the long-term measurement results
- **WFMCOUNT**: the number of waveforms used for the displayed results

Return values:

<WaveformCount>

Usage: Query only**16.12.7 Current Harmonic**

| | |
|--|-----|
| POWER:HARMonics:AVailable? | 693 |
| POWER:HARMonics:DOFRequency | 694 |
| POWER:HARMonics:ENFRequency | 694 |
| POWER:HARMonics:EXECute | 694 |
| POWER:HARMonics:MEASurement:DURation? | 694 |
| POWER:HARMonics:MEASurement:FREquency:AVG? | 694 |
| POWER:HARMonics:MEASurement:FREquency:NPEak? | 694 |
| POWER:HARMonics:MEASurement:FREquency:PPEak? | 695 |
| POWER:HARMonics:MEASurement:FREquency:STDDev? | 695 |
| POWER:HARMonics:MEASurement:FREquency[:ACTual]? | 695 |
| POWER:HARMonics:MEASurement:REALpower[:ACTual]? | 695 |
| POWER:HARMonics:MEASurement:THDistortion:AVG? | 695 |
| POWER:HARMonics:MEASurement:THDistortion:NPEak? | 695 |
| POWER:HARMonics:MEASurement:THDistortion:PPEak? | 696 |
| POWER:HARMonics:MEASurement:THDistortion:STDDev? | 696 |
| POWER:HARMonics:MEASurement:THDistortion[:ACTual]? | 696 |
| POWER:HARMonics:MIFRequency | 696 |
| POWER:HARMonics:REPort:ADD | 696 |
| POWER:HARMonics:RESult<n>:FREquency? | 696 |
| POWER:HARMonics:RESult<n>:LEVel:LIMit? | 697 |
| POWER:HARMonics:RESult<n>:LEVel[:VALue]? | 697 |
| POWER:HARMonics:RESult<n>:MAXimum? | 697 |
| POWER:HARMonics:RESult<n>:MEAN? | 697 |
| POWER:HARMonics:RESult<n>:MINimum? | 697 |
| POWER:HARMonics:RESult<n>:RESet | 698 |
| POWER:HARMonics:RESult<n>:VALid? | 698 |
| POWER:HARMonics:RESult<n>:VCOunt? | 698 |
| POWER:HARMonics:RESult<n>:WFMCOUNT? | 698 |
| POWER:HARMonics:STANdard | 698 |
| EXPort:POWER:NAME | 699 |
| EXPort:POWER:SAVE | 699 |

POWER:HARMonics:AVailable?

Returns the number of measured harmonics.

Return values:

<HarmonicsCount>

Usage: Query only

POWer:HARMonics:DOFrequency <DoFrequency>

Selects the frequency of the input signal if `POWer:HARMonics:STANdard` is set to RTC.

Parameters:

<DoFrequency> F400 | NVF | WVF

POWer:HARMonics:ENFrequency <ENFrequency>

Selects the frequency of the input signal if `POWer:HARMonics:STANdard` is set to ENA/ENB/ENC/END.

Parameters:

<ENFrequency> AUTO | F50 | F60

POWer:HARMonics:EXECute

Starts the current harmonics measurement.

Usage: Event

POWer:HARMonics:MEASurement:DURation?

Returns the time duration of the measurement.

Return values:

<MeasurementDuration>

Usage: Query only

POWer:HARMonics:MEASurement:FREQuency:AVG?

Returns the average frequency of the measured signal.

Return values:

<AverageValue>

Usage: Query only

POWer:HARMonics:MEASurement:FREQuency:NPEak?

Returns the minimum frequency of the measured signal.

Return values:

<MinimumValue>

Usage: Query only

POWER:HARMONics:MEASurement:FREQuency:PPeak?

Returns the maximum frequency of the measured signal.

Return values:

<MaximumValue>

Usage: Query only

POWER:HARMONics:MEASurement:FREQuency:STDDev?

Returns the standard deviation of frequencies of the measured signal.

Return values:

<DeviationValue>

Usage: Query only

POWER:HARMONics:MEASurement:FREQuency[:ACTual]?

Returns the current frequency value.

Return values:

<ActualValue>

Usage: Query only

POWER:HARMONics:MEASurement:REALpower[:ACTual]?

Returns the measured total power, which is used for dynamic calculation of the limits.

Return values:

<RealPower>

Usage: Query only

POWER:HARMONics:MEASurement:THDistortion:AVG?

Returns the average total harmonic distortion of the measured signal.

Return values:

<AverageValue>

Usage: Query only

POWER:HARMONics:MEASurement:THDistortion:NPEak?

Returns the minimum total harmonic distortion of the measured signal.

Return values:

<MinimumValue>

Usage: Query only

POWer:HARMonics:MEASurement:THDistortion:PPeak?

Returns the maximum total harmonic distortion of the measured signal.

Return values:

<MaximumValue>

Usage: Query only

POWer:HARMonics:MEASurement:THDistortion:STDDev?

Returns the standard deviation of total harmonic distortions of the measured signal.

Return values:

<DeviationValue>

Usage: Query only

POWer:HARMonics:MEASurement:THDistortion[:ACTual]?

Returns the current total harmonic distortion value.

Return values:

<ActualValue>

Usage: Query only

POWer:HARMonics:MIFrequency <MILFrequency>

Selects the frequency of the input signal when `POWer:HARMonics:STANdard` is set to `MIL`.

Parameters:

<MILFrequency> F60 | F400

POWer:HARMonics:REPort:ADD

Adds the result to the report list.

Usage: Event

POWer:HARMonics:RESult<n>:FREQency?

Queries the frequency of the n-th harmonic.

Suffix:

<n> 1..40

Return values:

<Frequency>

Usage: Query only

POWER:HARMONics:RESult<n>:LEVel:LIMit?

Queries the limit for the level of the n-th harmonic.

Suffix:

<n> 1..40

Return values:

<LevelLimit>

Usage: Query only

POWER:HARMONics:RESult<n>:LEVel[:VALue]?

Queries the level of the n-th harmonic.

Suffix:

<n> 1..40

Return values:

<Level>

Usage: Query only

POWER:HARMONics:RESult<n>:MAXimum?

Queries the maximum level of the n-th harmonic.

Suffix:

<n> 1..40

Return values:

<LevelMaximum>

Usage: Query only

POWER:HARMONics:RESult<n>:MEAN?

Queries the average level of the n-th harmonic.

Suffix:

<n> 1..40

Return values:

<LevelAverage>

Usage: Query only

POWER:HARMONics:RESult<n>:MINimum?

Queries the minimum level of the n-th harmonic.

Suffix:

<n> 1..40

Return values:
<LevelMinimum>

Usage: Query only

POWer:HARMonics:RESult<n>:RESet

Resets the count of the measurements.

Suffix:
<n> 1..40

Usage: Event

POWer:HARMonics:RESult<n>:VALid?

Queries if the value of n-th harmonic is within the limit for the current measurement.

Suffix:
<n> 1..40

Return values:
<Valid> PASS | FAIL

Usage: Query only

POWer:HARMonics:RESult<n>:VCOunt?

Queries the number of waveforms, for which the limit value of at least one harmonic was violated.

Suffix:
<n> 1..40

Parameters:
<ViolateCount>

Usage: Query only

POWer:HARMonics:RESult<n>:WFMCount?

Queries the number of waveforms, for which the harmonics were measured.

Suffix:
<n> 1..40

Return values:
<WaveformCount>

Usage: Query only

POWer:HARMonics:STANdard <Standard>

Sets a standard for the current harmonic measurement.

Parameters:

<Standard> ENA | ENB | ENC | END | MIL | RTC

EXPort:POWer:NAME <ExportPath>

Defines the path and filename for results of harmonics and spectrum power measurements. Results are saved with `EXPort:POWer:SAVE`. The file format is CSV, the filename is incremented automatically.

Parameters:

<ExportPath> String parameter

EXPort:POWer:SAVE

Saves the harmonics and spectrum measurement results to the path and file defined by `EXPort:POWer:NAME`.

Usage: Event

16.12.8 Inrush Current

| | |
|--|-----|
| <code>POWer:INRushcurrent:EXECute</code> | 699 |
| <code>POWer:INRushcurrent:GATE<n>:START</code> | 699 |
| <code>POWer:INRushcurrent:GATE<n>:STOP</code> | 699 |
| <code>POWer:INRushcurrent:GCOut</code> | 700 |
| <code>POWer:INRushcurrent:REPort:ADD</code> | 700 |
| <code>POWer:INRushcurrent:RESult<n>:AREA?</code> | 700 |
| <code>POWer:INRushcurrent:RESult<n>:MAXCurrent?</code> | 700 |

POWer:INRushcurrent:EXECute

Starts the inrush current measurement.

Usage: Event

POWer:INRushcurrent:GATE<n>:START <StartTime>

Sets the start measuring time for the selected gate.

Suffix:

<n> 1..3

Parameters:

<StartTime>

POWer:INRushcurrent:GATE<n>:STOP <StopTime>

Sets the stop measuring time for the selected gate.

Suffix:
<n> 1..3

Parameters:
<StopTime>

POWER:INRushcurrent:GCOunt <GateCount>

Sets the number of inrush current gates.

Parameters:
<GateCount> *RST: 1

POWER:INRushcurrent:REPort:ADD

Adds the result to the report list.

Usage: Event

POWER:INRushcurrent:RESult<n>:AREA?

Queries the area of the corresponding gate.

Suffix:
<n> 1..3

Return values:
<AreaValue>

Usage: Query only

POWER:INRushcurrent:RESult<n>:MAXCurrent?

Queires the maximum current for the corresponding gate.

Suffix:
<n> 1..3

Return values:
<MaxCurrentValue>

Usage: Query only

16.12.9 Modulation Analysis

| | |
|--|-----|
| POWER:MODulation:TYPE..... | 701 |
| POWER:MODulation:THReshold[:UPPer]..... | 702 |
| POWER:MODulation:THReshold:LOWer..... | 702 |
| POWER:MODulation:THReshold:HYSteresis..... | 702 |
| POWER:MODulation:EXECute..... | 702 |
| POWER:MODulation:REPort:ADD..... | 702 |
| POWER:MODulation:RESult:LPEak:AVG?..... | 702 |

| | |
|---|-----|
| POWer:MODulation:RESult:LPEak:NPEak?..... | 702 |
| POWer:MODulation:RESult:LPEak:PPEak?..... | 702 |
| POWer:MODulation:RESult:LPEak:STDDev?..... | 702 |
| POWer:MODulation:RESult:LPEak:WFMCount?..... | 702 |
| POWer:MODulation:RESult:LPEak[:ACTual]?..... | 702 |
| POWer:MODulation:RESult:MEAN[:ACTual]?..... | 702 |
| POWer:MODulation:RESult:MEAN:AVG?..... | 702 |
| POWer:MODulation:RESult:MEAN:NPEak?..... | 702 |
| POWer:MODulation:RESult:MEAN:PPEak?..... | 703 |
| POWer:MODulation:RESult:MEAN:STDDev?..... | 703 |
| POWer:MODulation:RESult:MEAN:WFMCount?..... | 703 |
| POWer:MODulation:RESult:RMS[:ACTual]?..... | 703 |
| POWer:MODulation:RESult:RMS:AVG?..... | 703 |
| POWer:MODulation:RESult:RMS:NPEak?..... | 703 |
| POWer:MODulation:RESult:RMS:PPEak?..... | 703 |
| POWer:MODulation:RESult:RMS:STDDev?..... | 703 |
| POWer:MODulation:RESult:RMS:WFMCount?..... | 703 |
| POWer:MODulation:RESult:STDDev[:ACTual]?..... | 703 |
| POWer:MODulation:RESult:STDDev:AVG?..... | 703 |
| POWer:MODulation:RESult:STDDev:NPEak?..... | 703 |
| POWer:MODulation:RESult:STDDev:PPEak?..... | 703 |
| POWer:MODulation:RESult:STDDev:STDDev?..... | 703 |
| POWer:MODulation:RESult:STDDev:WFMCount?..... | 703 |
| POWer:MODulation:RESult:UPEak:AVG?..... | 704 |
| POWer:MODulation:RESult:UPEak:NPEak?..... | 704 |
| POWer:MODulation:RESult:UPEak:PPEak?..... | 704 |
| POWer:MODulation:RESult:UPEak:STDDev?..... | 704 |
| POWer:MODulation:RESult:UPEak[:ACTual]?..... | 704 |
| POWer:MODulation:RESult:UPEakWFMCount?..... | 704 |

POWer:MODulation:TYPE <ModulationType>

Sets the modulation type.

Parameters:

<ModulationType> PERiod | FREquency | DCYcle | PWIDth | UPERiod |
 UFRequency | UDCYcle | UPWidth | BPERiod | BFRrequency |
 BDCYcle | BPWidth
 PERiod, UPERiod: "Track Period"
 BPERiod: "Track Period Bipolar"
 FREquency, UFRequency: "Track Frequency"
 BFRrequency: "Track Frequency Bipolar"
 DCYcle, UDCYcle: "Track Duty Cycle"
 BDCYcle: "Track Duty Cycle Bipolar"
 PWIDth, UPWidth: "Track Pulse Width"
 BPWidth: "Track Pulse Width Bipolar"

POWER:MODulation:THReshold[:UPPer] <ThresholdLevel>

Sets the threshold for unipolar sources, or the upper level for bipolar sources. The signal is measured at the crossing points of the signal with the threshold.

Parameters:

<ThresholdLevel> Default unit: V

POWER:MODulation:THReshold:LOWer <ThresholdLevel>

Sets the lower level for bipolar sources, which determines the crossing points on negative pulses.

Parameters:

<ThresholdLevel> Default unit: V

POWER:MODulation:THReshold:HYSteresis <Hysteresis>

Sets the hysteresis for correct edge detection.

Parameters:

<Hysteresis> Default unit: V

POWER:MODulation:EXECute

Starts the modulation analysis measurement.

Usage: Event

POWER:MODulation:REPort:ADD

Adds the result to the report list.

Usage: Event

POWER:MODulation:RESult:LPEak:AVG?
POWER:MODulation:RESult:LPEak:NPEak?
POWER:MODulation:RESult:LPEak:PPEak?
POWER:MODulation:RESult:LPEak:STDDev?
POWER:MODulation:RESult:LPEak:WFMCount?
POWER:MODulation:RESult:LPEak[:ACTual]?

Return values:

<ActualValue>

Usage: Query only

POWER:MODulation:RESult:MEAN[:ACTual]?

POWER:MODulation:RESult:MEAN:AVG?

POWER:MODulation:RESult:MEAN:NPEak?

POWER:MODulation:RESult:MEAN:PPEak?
POWER:MODulation:RESult:MEAN:STDDev?
POWER:MODulation:RESult:MEAN:WFMCCount?

Returns the corresponding statistic result for "Mean".

- [:ACTual] : current measurement result
- AVG : average of the long-term measurement results
- NPEak : negative peak value of the long-term measurement results
- PPEak : positive peak value of the long-term measurement results
- STDDev : standard deviation of the long-term measurement results
- WFMCCount : the number of waveforms used for the displayed results

Return values:

<WaveformCount>

Usage: Query only

POWER:MODulation:RESult:RMS[:ACTual]?
POWER:MODulation:RESult:RMS:AVG?
POWER:MODulation:RESult:RMS:NPEak?
POWER:MODulation:RESult:RMS:PPEak?
POWER:MODulation:RESult:RMS:STDDev?
POWER:MODulation:RESult:RMS:WFMCCount?

Returns the corresponding statistic result for RMS.

- [:ACTual] : current measurement result
- AVG : average of the long-term measurement results
- NPEak : negative peak value of the long-term measurement results
- PPEak : positive peak value of the long-term measurement results
- STDDev : standard deviation of the long-term measurement results
- WFMCCount : the number of waveforms used for the displayed results

Return values:

<WaveformCount>

Usage: Query only

POWER:MODulation:RESult:STDDev[:ACTual]?
POWER:MODulation:RESult:STDDev:AVG?
POWER:MODulation:RESult:STDDev:NPEak?
POWER:MODulation:RESult:STDDev:PPEak?
POWER:MODulation:RESult:STDDev:STDDev?
POWER:MODulation:RESult:STDDev:WFMCCount?

Returns the corresponding statistic result for the standard deviation.

- [:ACTual] : current measurement result
- AVG : average of the long-term measurement results

- **NPEak**: negative peak value of the long-term measurement results
- **PPEak**: positive peak value of the long-term measurement results
- **STDDev**: standard deviation of the long-term measurement results
- **WFMCOUNT**: the number of waveforms used for the displayed results

Return values:

<WaveformCount>

Usage: Query only

POWER:MODulation:RESult:UPEak:AVG?
POWER:MODulation:RESult:UPEak:NPEak?
POWER:MODulation:RESult:UPEak:PPEak?
POWER:MODulation:RESult:UPEak:STDDev?
POWER:MODulation:RESult:UPEak[:ACTual]?
POWER:MODulation:RESult:UPEakWFMCOUNT?

Returns the corresponding statistic result for "Vp+".

- **[:ACTual]**: current measurement result
- **AVG**: average of the long-term measurement results
- **NPEak**: negative peak value of the long-term measurement results
- **PPEak**: positive peak value of the long-term measurement results
- **STDDev**: standard deviation of the long-term measurement results
- **WFMCOUNT**: the number of waveforms used for the displayed results

Return values:

<WaveformCount>

Usage: Query only**16.12.10 Turn On/Off**

| | |
|---|-----|
| POWER:ONOff:EXECute | 704 |
| POWER:ONOff:MEASurement | 704 |
| POWER:ONOff:REPort:ADD | 705 |
| POWER:ONOff:RESult<n>:TIME? | 705 |

POWER:ONOff:EXECute

Starts the turn on/off measurement.

Usage: Event**POWER:ONOff:MEASurement <MeasureType>**

Selects the turn on or the turn off measurement.

Parameters:

<MeasureType> TON | TOFF
 *RST: TON

POWER:ONOFF:REPort:ADD

Adds the result to the report list.

Usage: Event

POWER:ONOFF:RESult<n>:TIME?

Queries the turn on/ turn off time. You can select the type of measurement with
[POWER:ONOFF:MEASurement](#).

Suffix:

<n> 1..3

Return values:

<Value>

Usage: Query only

16.12.11 Quality

| | |
|---|-----|
| POWER:QUALity:EXECute | 706 |
| POWER:QUALity:REPort:ADD | 707 |
| POWER:QUALity:RESult:CURRent:CREStfactor:AVG? | 707 |
| POWER:QUALity:RESult:CURRent:FREQuency:AVG? | 707 |
| POWER:QUALity:RESult:CURRent:RMS:AVG? | 707 |
| POWER:QUALity:RESult:POWer:APParent:AVG? | 707 |
| POWER:QUALity:RESult:POWer:PFACTOR:AVG? | 707 |
| POWER:QUALity:RESult:POWer:PHASe:AVG? | 707 |
| POWER:QUALity:RESult:POWer:REACTive:AVG? | 707 |
| POWER:QUALity:RESult:POWer:REALpower:AVG? | 707 |
| POWER:QUALity:RESult:VOLTagE:CREStfactor:AVG? | 707 |
| POWER:QUALity:RESult:VOLTagE:FREQuency:AVG? | 707 |
| POWER:QUALity:RESult:VOLTagE:RMS:AVG? | 707 |
| POWER:QUALity:RESult:CURRent:CREStfactor:NPEak? | 707 |
| POWER:QUALity:RESult:CURRent:FREQuency:NPEak? | 707 |
| POWER:QUALity:RESult:CURRent:RMS:NPEak? | 707 |
| POWER:QUALity:RESult:POWer:APParent:NPEak? | 707 |
| POWER:QUALity:RESult:POWer:PFACTOR:NPEak? | 707 |
| POWER:QUALity:RESult:POWer:PHASe:NPEak? | 707 |
| POWER:QUALity:RESult:POWer:REACTive:NPEak? | 707 |
| POWER:QUALity:RESult:POWer:REALpower:NPEak? | 707 |
| POWER:QUALity:RESult:VOLTagE:CREStfactor:NPEak? | 707 |
| POWER:QUALity:RESult:VOLTagE:FREQuency:NPEak? | 707 |
| POWER:QUALity:RESult:VOLTagE:RMS:NPEak? | 707 |
| POWER:QUALity:RESult:CURRent:CREStfactor:PPEak? | 707 |

| | |
|--|-----|
| POWer:QUALity:RESult:CURRent:FREQuency:PPEak? | 707 |
| POWer:QUALity:RESult:CURRent:RMS:PPEak? | 707 |
| POWer:QUALity:RESult:POWer:APParent:PPEak? | 707 |
| POWer:QUALity:RESult:POWer:PFACTOR:PPEak? | 707 |
| POWer:QUALity:RESult:POWer:PHASe:PPEak? | 707 |
| POWer:QUALity:RESult:POWer:REACTive:PPEak? | 707 |
| POWer:QUALity:RESult:POWer:REALpower:PPEak? | 708 |
| POWer:QUALity:RESult:VOLTagE:CREStfactor:PPEak? | 708 |
| POWer:QUALity:RESult:VOLTagE:FREQuency:PPEak? | 708 |
| POWer:QUALity:RESult:VOLTagE:RMS:PPEak? | 708 |
| POWer:QUALity:RESult:CURRent:CREStfactor:STDDev? | 708 |
| POWer:QUALity:RESult:CURRent:FREQuency:STDDev? | 708 |
| POWer:QUALity:RESult:CURRent:RMS:STDDev? | 708 |
| POWer:QUALity:RESult:POWer:APParent:STDDev? | 708 |
| POWer:QUALity:RESult:POWer:PFACTOR:STDDev? | 708 |
| POWer:QUALity:RESult:POWer:PHASe:STDDev? | 708 |
| POWer:QUALity:RESult:POWer:REACTive:STDDev? | 708 |
| POWer:QUALity:RESult:POWer:REALpower:STDDev? | 708 |
| POWer:QUALity:RESult:VOLTagE:CREStfactor:STDDev? | 708 |
| POWer:QUALity:RESult:VOLTagE:FREQuency:STDDev? | 708 |
| POWer:QUALity:RESult:VOLTagE:RMS:STDDev? | 708 |
| POWer:QUALity:RESult:CURRent:CREStfactor:WFMCount? | 708 |
| POWer:QUALity:RESult:CURRent:FREQuency:WFMCount? | 708 |
| POWer:QUALity:RESult:CURRent:RMS:WFMCount? | 708 |
| POWer:QUALity:RESult:POWer:APParent:WFMCount? | 708 |
| POWer:QUALity:RESult:POWer:PFACTOR:WFMCount? | 708 |
| POWer:QUALity:RESult:POWer:PHASe:WFMCount? | 708 |
| POWer:QUALity:RESult:POWer:REACTive:WFMCount? | 708 |
| POWer:QUALity:RESult:POWer:REALpower:WFMCount? | 708 |
| POWer:QUALity:RESult:VOLTagE:CREStfactor:WFMCount? | 708 |
| POWer:QUALity:RESult:VOLTagE:FREQuency:WFMCount? | 708 |
| POWer:QUALity:RESult:VOLTagE:RMS:WFMCount? | 708 |
| POWer:QUALity:RESult:CURRent:CREStfactor[:ACTual]? | 708 |
| POWer:QUALity:RESult:CURRent:FREQuency[:ACTual]? | 708 |
| POWer:QUALity:RESult:CURRent:RMS[:ACTual]? | 709 |
| POWer:QUALity:RESult:POWer:APParent[:ACTual]? | 709 |
| POWer:QUALity:RESult:POWer:PFACTOR[:ACTual]? | 709 |
| POWer:QUALity:RESult:POWer:PHASe[:ACTual]? | 709 |
| POWer:QUALity:RESult:POWer:REACTive[:ACTual]? | 709 |
| POWer:QUALity:RESult:POWer:REALpower[:ACTual]? | 709 |
| POWer:QUALity:RESult:VOLTagE:CREStfactor[:ACTual]? | 709 |
| POWer:QUALity:RESult:VOLTagE:FREQuency[:ACTual]? | 709 |
| POWer:QUALity:RESult:VOLTagE:RMS[:ACTual]? | 709 |

POWer:QUALity:EXECute

Starts the power quality measurement.

Usage: Event

POWER:QUALity:REPort:ADD

Adds the result to the report list.

Usage: Event

POWER:QUALity:RESult:CURRent:CREStfactor:AVG?
POWER:QUALity:RESult:CURRent:FREQuency:AVG?
POWER:QUALity:RESult:CURRent:RMS:AVG?
POWER:QUALity:RESult:POWer:APParent:AVG?
POWER:QUALity:RESult:POWer:PFACTOR:AVG?
POWER:QUALity:RESult:POWer:PHASe:AVG?
POWER:QUALity:RESult:POWer:REACTive:AVG?
POWER:QUALity:RESult:POWer:REALpower:AVG?
POWER:QUALity:RESult:VOLTagE:CREStfactor:AVG?
POWER:QUALity:RESult:VOLTagE:FREQuency:AVG?
POWER:QUALity:RESult:VOLTagE:RMS:AVG?

Returns the average value of the specified measurement series.

Return values:

<AverageValue> Statistic value

Usage: Query only

POWER:QUALity:RESult:CURRent:CREStfactor:NPEak?
POWER:QUALity:RESult:CURRent:FREQuency:NPEak?
POWER:QUALity:RESult:CURRent:RMS:NPEak?
POWER:QUALity:RESult:POWer:APParent:NPEak?
POWER:QUALity:RESult:POWer:PFACTOR:NPEak?
POWER:QUALity:RESult:POWer:PHASe:NPEak?
POWER:QUALity:RESult:POWer:REACTive:NPEak?
POWER:QUALity:RESult:POWer:REALpower:NPEak?
POWER:QUALity:RESult:VOLTagE:CREStfactor:NPEak?
POWER:QUALity:RESult:VOLTagE:FREQuency:NPEak?
POWER:QUALity:RESult:VOLTagE:RMS:NPEak?

Returns the minimum value of the specified measurement series.

Return values:

<MinimumValue> Statistic value

Usage: Query only

POWER:QUALity:RESult:CURRent:CREStfactor:PPEak?
POWER:QUALity:RESult:CURRent:FREQuency:PPEak?
POWER:QUALity:RESult:CURRent:RMS:PPEak?
POWER:QUALity:RESult:POWer:APParent:PPEak?
POWER:QUALity:RESult:POWer:PFACTOR:PPEak?
POWER:QUALity:RESult:POWer:PHASe:PPEak?
POWER:QUALity:RESult:POWer:REACTive:PPEak?

POWER:QUALity:RESult:POWER:REALpower:PPEak?
POWER:QUALity:RESult:VOLTage:CREStfactor:PPEak?
POWER:QUALity:RESult:VOLTage:FREQuency:PPEak?
POWER:QUALity:RESult:VOLTage:RMS:PPEak?

Returns the maximum value of the specified measurement series.

Return values:

<MaximumValue> Statistic value

Usage: Query only

POWER:QUALity:RESult:CURREnt:CREStfactor:STDDev?
POWER:QUALity:RESult:CURREnt:FREQuency:STDDev?
POWER:QUALity:RESult:CURREnt:RMS:STDDev?
POWER:QUALity:RESult:POWER:APParent:STDDev?
POWER:QUALity:RESult:POWER:PFACTOR:STDDev?
POWER:QUALity:RESult:POWER:PHASe:STDDev?
POWER:QUALity:RESult:POWER:REACTIVE:STDDev?
POWER:QUALity:RESult:POWER:REALpower:STDDev?
POWER:QUALity:RESult:VOLTage:CREStfactor:STDDev?
POWER:QUALity:RESult:VOLTage:FREQuency:STDDev?
POWER:QUALity:RESult:VOLTage:RMS:STDDev?

Returns the statistical standard deviation of the specified measurement series.

Return values:

<DeviationValue> Statistic value

Usage: Query only

POWER:QUALity:RESult:CURREnt:CREStfactor:WFMCOUNT?
POWER:QUALity:RESult:CURREnt:FREQuency:WFMCOUNT?
POWER:QUALity:RESult:CURREnt:RMS:WFMCOUNT?
POWER:QUALity:RESult:POWER:APParent:WFMCOUNT?
POWER:QUALity:RESult:POWER:PFACTOR:WFMCOUNT?
POWER:QUALity:RESult:POWER:PHASe:WFMCOUNT?
POWER:QUALity:RESult:POWER:REACTIVE:WFMCOUNT?
POWER:QUALity:RESult:POWER:REALpower:WFMCOUNT?
POWER:QUALity:RESult:VOLTage:CREStfactor:WFMCOUNT?
POWER:QUALity:RESult:VOLTage:FREQuency:WFMCOUNT?
POWER:QUALity:RESult:VOLTage:RMS:WFMCOUNT?

Returns the current number of measured waveforms.

Return values:

<WaveformCount> Statistic value

Usage: Query only

POWER:QUALity:RESult:CURREnt:CREStfactor[:ACTual]?
POWER:QUALity:RESult:CURREnt:FREQuency[:ACTual]?

POWer:QUALity:RESult:CURRent:RMS[:ACTual]?
POWer:QUALity:RESult:POWer:APParent[:ACTual]?
POWer:QUALity:RESult:POWer:PFACTOR[:ACTual]?
POWer:QUALity:RESult:POWer:PHASe[:ACTual]?
POWer:QUALity:RESult:POWer:REACTive[:ACTual]?
POWer:QUALity:RESult:POWer:REALpower[:ACTual]?
POWer:QUALity:RESult:VOLTagE:CREStfactor[:ACTual]?
POWer:QUALity:RESult:VOLTagE:FREQuency[:ACTual]?
POWer:QUALity:RESult:VOLTagE:RMS[:ACTual]?

Returns the instantaneous result of the specified measurement.

Return values:

<ActualValue> Measurement result. If no measurement was executed, no value (NAN) is returned.

Usage: Query only

16.12.12 Ripple

| | |
|---|-----|
| POWer:RIPPlE:EXECute..... | 710 |
| POWer:RIPPlE:REPort:ADD..... | 710 |
| POWer:RIPPlE:RESult:FREQuency[:ACTual]? | 710 |
| POWer:RIPPlE:RESult:FREQuency:AVG? | 710 |
| POWer:RIPPlE:RESult:FREQuency:NPEak? | 710 |
| POWer:RIPPlE:RESult:FREQuency:PPEak? | 710 |
| POWer:RIPPlE:RESult:FREQuency:STDDev? | 710 |
| POWer:RIPPlE:RESult:FREQuency:WFMCOUNT? | 710 |
| POWer:RIPPlE:RESult:LPEak[:ACTual]? | 711 |
| POWer:RIPPlE:RESult:LPEak:AVG? | 711 |
| POWer:RIPPlE:RESult:LPEak:NPEak? | 711 |
| POWer:RIPPlE:RESult:LPEak:PPEak? | 711 |
| POWer:RIPPlE:RESult:LPEak:STDDev? | 711 |
| POWer:RIPPlE:RESult:LPEak:WFMCOUNT? | 711 |
| POWer:RIPPlE:RESult:MEAN[:ACTual]? | 711 |
| POWer:RIPPlE:RESult:MEAN:AVG? | 711 |
| POWer:RIPPlE:RESult:MEAN:NPEak? | 711 |
| POWer:RIPPlE:RESult:MEAN:PPEak? | 711 |
| POWer:RIPPlE:RESult:MEAN:STDDev? | 711 |
| POWer:RIPPlE:RESult:MEAN:WFMCOUNT? | 711 |
| POWer:RIPPlE:RESult:NDCYcle[:ACTual]? | 712 |
| POWer:RIPPlE:RESult:NDCYcle:AVG? | 712 |
| POWer:RIPPlE:RESult:NDCYcle:NPEak? | 712 |
| POWer:RIPPlE:RESult:NDCYcle:PPEak? | 712 |
| POWer:RIPPlE:RESult:NDCYcle:STDDev? | 712 |
| POWer:RIPPlE:RESult:NDCYcle:WFMCOUNT? | 712 |
| POWer:RIPPlE:RESult:PDCYcle[:ACTual]? | 712 |
| POWer:RIPPlE:RESult:PDCYcle:AVG? | 712 |
| POWer:RIPPlE:RESult:PDCYcle:NPEak? | 712 |
| POWer:RIPPlE:RESult:PDCYcle:PPEak? | 712 |
| POWer:RIPPlE:RESult:PDCYcle:STDDev? | 712 |

| | |
|--|-----|
| POWer:RIPPlE:RESult:PDCYcle:WFMCount?..... | 712 |
| POWer:RIPPlE:RESult:PEAK[:ACTual]?..... | 712 |
| POWer:RIPPlE:RESult:PEAK:AVG?..... | 712 |
| POWer:RIPPlE:RESult:PEAK:NPEak?..... | 712 |
| POWer:RIPPlE:RESult:PEAK:PPEak?..... | 712 |
| POWer:RIPPlE:RESult:PEAK:STDDev?..... | 713 |
| POWer:RIPPlE:RESult:PEAK:WFMCount?..... | 713 |
| POWer:RIPPlE:RESult:PERiod[:ACTual]?..... | 713 |
| POWer:RIPPlE:RESult:PERiod:AVG?..... | 713 |
| POWer:RIPPlE:RESult:PERiod:NPEak?..... | 713 |
| POWer:RIPPlE:RESult:PERiod:PPEak?..... | 713 |
| POWer:RIPPlE:RESult:PERiod:STDDev?..... | 713 |
| POWer:RIPPlE:RESult:PERiod:WFMCount?..... | 713 |
| POWer:RIPPlE:RESult:STDDev[:ACTual]?..... | 713 |
| POWer:RIPPlE:RESult:STDDev:AVG?..... | 713 |
| POWer:RIPPlE:RESult:STDDev:NPEak?..... | 713 |
| POWer:RIPPlE:RESult:STDDev:PPEak?..... | 713 |
| POWer:RIPPlE:RESult:STDDev:STDDev?..... | 713 |
| POWer:RIPPlE:RESult:STDDev:WFMCount?..... | 713 |
| POWer:RIPPlE:RESult:UPEak[:ACTual]?..... | 714 |
| POWer:RIPPlE:RESult:UPEak:AVG?..... | 714 |
| POWer:RIPPlE:RESult:UPEak:NPEak?..... | 714 |
| POWer:RIPPlE:RESult:UPEak:PPEak?..... | 714 |
| POWer:RIPPlE:RESult:UPEak:STDDev?..... | 714 |
| POWer:RIPPlE:RESult:UPEak:WFMCount?..... | 714 |

POWer:RIPPlE:EXECute

Starts the ripple measurement.

Usage: Event

POWer:RIPPlE:REPort:ADD

Adds the result to the report list.

Usage: Event

POWer:RIPPlE:RESult:FREQUency[:ACTual]?

POWer:RIPPlE:RESult:FREQUency:AVG?

POWer:RIPPlE:RESult:FREQUency:NPEak?

POWer:RIPPlE:RESult:FREQUency:PPEak?

POWer:RIPPlE:RESult:FREQUency:STDDev?

POWer:RIPPlE:RESult:FREQUency:WFMCount?

Returns the corresponding statistic result for the frequency.

- [:ACTual] : current measurement result
- AVG : average of the long-term measurement results
- NPEak : negative peak value of the long-term measurement results

- **PPEak**: positive peak value of the long-term measurement results
- **STDDev**: standard deviation of the long-term measurement results
- **WFMCOUNT**: the number of waveforms used for the displayed results

Return values:

<WaveformCount>

Usage: Query only**POWER:RIPPLE:RESult:LPEak[:ACTual]?****POWER:RIPPLE:RESult:LPEak:AVG?****POWER:RIPPLE:RESult:LPEak:NPEak?****POWER:RIPPLE:RESult:LPEak:PPEak?****POWER:RIPPLE:RESult:LPEak:STDDev?****POWER:RIPPLE:RESult:LPEak:WFMCOUNT?**

Returns the corresponding statistic result for "Vp-".

- **[:ACTual]**: current measurement result
- **AVG**: average of the long-term measurement results
- **NPEak**: negative peak value of the long-term measurement results
- **PPEak**: positive peak value of the long-term measurement results
- **STDDev**: standard deviation of the long-term measurement results
- **WFMCOUNT**: the number of waveforms used for the displayed results

Return values:

<WaveformCount>

Usage: Query only**POWER:RIPPLE:RESult:MEAN[:ACTual]?****POWER:RIPPLE:RESult:MEAN:AVG?****POWER:RIPPLE:RESult:MEAN:NPEak?****POWER:RIPPLE:RESult:MEAN:PPEak?****POWER:RIPPLE:RESult:MEAN:STDDev?****POWER:RIPPLE:RESult:MEAN:WFMCOUNT?**

Returns the corresponding statistic result for "Mean".

- **[:ACTual]**: current measurement result
- **AVG**: average of the long-term measurement results
- **NPEak**: negative peak value of the long-term measurement results
- **PPEak**: positive peak value of the long-term measurement results
- **STDDev**: standard deviation of the long-term measurement results
- **WFMCOUNT**: the number of waveforms used for the displayed results

Return values:

<WaveformCount>

Usage: Query only

POWER:RIPPLE:RESult:NDCYcle[:ACTual]?
POWER:RIPPLE:RESult:NDCYcle:AVG?
POWER:RIPPLE:RESult:NDCYcle:NPEak?
POWER:RIPPLE:RESult:NDCYcle:PPEak?
POWER:RIPPLE:RESult:NDCYcle:STDDev?
POWER:RIPPLE:RESult:NDCYcle:WFMCCount?

Returns the corresponding statistic result for the negative duty cycle.

- [:ACTual] : current measurement result
- AVG : average of the long-term measurement results
- NPEak : negative peak value of the long-term measurement results
- PPEak : positive peak value of the long-term measurement results
- STDDev : standard deviation of the long-term measurement results
- WFMCCount : the number of waveforms used for the displayed results

Return values:

<WaveformCount>

Usage: Query only

POWER:RIPPLE:RESult:PDCYcle[:ACTual]?
POWER:RIPPLE:RESult:PDCYcle:AVG?
POWER:RIPPLE:RESult:PDCYcle:NPEak?
POWER:RIPPLE:RESult:PDCYcle:PPEak?
POWER:RIPPLE:RESult:PDCYcle:STDDev?
POWER:RIPPLE:RESult:PDCYcle:WFMCCount?

Returns the corresponding statistic result for the positive duty cycle.

- [:ACTual] : current measurement result
- AVG : average of the long-term measurement results
- NPEak : negative peak value of the long-term measurement results
- PPEak : positive peak value of the long-term measurement results
- STDDev : standard deviation of the long-term measurement results
- WFMCCount : the number of waveforms used for the displayed results

Return values:

<WaveformCount>

Usage: Query only

POWER:RIPPLE:RESult:PEAK[:ACTual]?
POWER:RIPPLE:RESult:PEAK:AVG?
POWER:RIPPLE:RESult:PEAK:NPEak?
POWER:RIPPLE:RESult:PEAK:PPEak?

POWER:RIPPLE:RESult:PEAK:STDDev?**POWER:RIPPLE:RESult:PEAK:WFMCOUNT?**

Returns the corresponding statistic result for "Vpp".

- [:ACTual] : current measurement result
- AVG : average of the long-term measurement results
- NPEak : negative peak value of the long-term measurement results
- PPEak : positive peak value of the long-term measurement results
- STDDev : standard deviation of the long-term measurement results
- WFMCOUNT : the number of waveforms used for the displayed results

Return values:

<WaveformCount>

Usage: Query only

POWER:RIPPLE:RESult:PERiod[:ACTual]?**POWER:RIPPLE:RESult:PERiod:AVG?****POWER:RIPPLE:RESult:PERiod:NPEak?****POWER:RIPPLE:RESult:PERiod:PPEak?****POWER:RIPPLE:RESult:PERiod:STDDev?****POWER:RIPPLE:RESult:PERiod:WFMCOUNT?**

Returns the corresponding statistic result for the period.

- [:ACTual] : current measurement result
- AVG : average of the long-term measurement results
- NPEak : negative peak value of the long-term measurement results
- PPEak : positive peak value of the long-term measurement results
- STDDev : standard deviation of the long-term measurement results
- WFMCOUNT : the number of waveforms used for the displayed results

Return values:

<WaveformCount>

Usage: Query only

POWER:RIPPLE:RESult:STDDev[:ACTual]?**POWER:RIPPLE:RESult:STDDev:AVG?****POWER:RIPPLE:RESult:STDDev:NPEak?****POWER:RIPPLE:RESult:STDDev:PPEak?****POWER:RIPPLE:RESult:STDDev:STDDev?****POWER:RIPPLE:RESult:STDDev:WFMCOUNT?**

Returns the corresponding statistic result for the standard deviation.

- [:ACTual] : current measurement result
- AVG : average of the long-term measurement results
- NPEak : negative peak value of the long-term measurement results

- **PPEak**: positive peak value of the long-term measurement results
- **STDDDev**: standard deviation of the long-term measurement results
- **WFMCCount**: the number of waveforms used for the displayed results

Return values:

<WaveformCount>

Usage: Query only**POWER:RIPPlE:RESult:UPEak[:ACTual]?****POWER:RIPPlE:RESult:UPEak:AVG?****POWER:RIPPlE:RESult:UPEak:NPEak?****POWER:RIPPlE:RESult:UPEak:PPEak?****POWER:RIPPlE:RESult:UPEak:STDDDev?****POWER:RIPPlE:RESult:UPEak:WFMCCount?**

Returns the corresponding statistic result for "Vp+".

- **[:ACTual]**: current measurement result
- **AVG**: average of the long-term measurement results
- **NPEak**: negative peak value of the long-term measurement results
- **PPEak**: positive peak value of the long-term measurement results
- **STDDDev**: standard deviation of the long-term measurement results
- **WFMCCount**: the number of waveforms used for the displayed results

Return values:

<WaveformCount>

Usage: Query only**16.12.13 Slew Rate**

| | |
|---|-----|
| POWER:SLEWrate:DSAMple | 715 |
| POWER:SLEWrate:DTIME | 716 |
| POWER:SLEWrate:EXECute | 716 |
| POWER:SLEWrate:REPort:ADD | 716 |
| POWER:RIPPlE:RESult:FREQuency[:ACTual]? | 716 |
| POWER:RIPPlE:RESult:FREQuency:AVG? | 716 |
| POWER:RIPPlE:RESult:FREQuency:NPEak? | 716 |
| POWER:RIPPlE:RESult:FREQuency:PPEak? | 716 |
| POWER:RIPPlE:RESult:FREQuency:STDDDev? | 716 |
| POWER:RIPPlE:RESult:FREQuency:WFMCCount? | 716 |
| POWER:SLEWrate:RESult:LPEak[:ACTual]? | 716 |
| POWER:SLEWrate:RESult:LPEak:AVG? | 716 |
| POWER:SLEWrate:RESult:LPEak:NPEak? | 716 |
| POWER:SLEWrate:RESult:LPEak:PPEak? | 716 |
| POWER:SLEWrate:RESult:LPEak:STDDDev? | 716 |
| POWER:SLEWrate:RESult:LPEak:WFMCCount? | 716 |
| POWER:RIPPlE:RESult:MEAN[:ACTual]? | 717 |

| | |
|---------------------------------------|-----|
| POWer:RIPPlE:RESult:MEAN:AVG? | 717 |
| POWer:RIPPlE:RESult:MEAN:NPEak? | 717 |
| POWer:RIPPlE:RESult:MEAN:PPEak? | 717 |
| POWer:RIPPlE:RESult:MEAN:STDDev? | 717 |
| POWer:RIPPlE:RESult:MEAN:WFMCount? | 717 |
| POWer:RIPPlE:RESult:NDCYcle[:ACTual]? | 717 |
| POWer:RIPPlE:RESult:NDCYcle:AVG? | 717 |
| POWer:RIPPlE:RESult:NDCYcle:NPEak? | 717 |
| POWer:RIPPlE:RESult:NDCYcle:PPEak? | 717 |
| POWer:RIPPlE:RESult:NDCYcle:STDDev? | 717 |
| POWer:RIPPlE:RESult:NDCYcle:WFMCount? | 717 |
| POWer:RIPPlE:RESult:PDCYcle[:ACTual]? | 718 |
| POWer:RIPPlE:RESult:PDCYcle:AVG? | 718 |
| POWer:RIPPlE:RESult:PDCYcle:NPEak? | 718 |
| POWer:RIPPlE:RESult:PDCYcle:PPEak? | 718 |
| POWer:RIPPlE:RESult:PDCYcle:STDDev? | 718 |
| POWer:RIPPlE:RESult:PDCYcle:WFMCount? | 718 |
| POWer:RIPPlE:RESult:PEAK[:ACTual]? | 718 |
| POWer:RIPPlE:RESult:PEAK:AVG? | 718 |
| POWer:RIPPlE:RESult:PEAK:NPEak? | 718 |
| POWer:RIPPlE:RESult:PEAK:PPEak? | 718 |
| POWer:RIPPlE:RESult:PEAK:STDDev? | 718 |
| POWer:RIPPlE:RESult:PEAK:WFMCount? | 718 |
| POWer:RIPPlE:RESult:PERiod[:ACTual]? | 718 |
| POWer:RIPPlE:RESult:PERiod:AVG? | 718 |
| POWer:RIPPlE:RESult:PERiod:NPEak? | 719 |
| POWer:RIPPlE:RESult:PERiod:PPEak? | 719 |
| POWer:RIPPlE:RESult:PERiod:STDDev? | 719 |
| POWer:RIPPlE:RESult:PERiod:WFMCount? | 719 |
| POWer:RIPPlE:RESult:STDDev[:ACTual]? | 719 |
| POWer:RIPPlE:RESult:STDDev:AVG? | 719 |
| POWer:RIPPlE:RESult:STDDev:NPEak? | 719 |
| POWer:RIPPlE:RESult:STDDev:PPEak? | 719 |
| POWer:RIPPlE:RESult:STDDev:STDDev? | 719 |
| POWer:RIPPlE:RESult:STDDev:WFMCount? | 719 |
| POWer:SLEWrate:RESult:UPEak[:ACTual]? | 719 |
| POWer:SLEWrate:RESult:UPEak:AVG? | 719 |
| POWer:SLEWrate:RESult:UPEak:NPEak? | 719 |
| POWer:SLEWrate:RESult:UPEak:PPEak? | 719 |
| POWer:SLEWrate:RESult:UPEak:STDDev? | 719 |
| POWer:SLEWrate:RESult:UPEak:WFMCount? | 719 |

POWer:SLEWrate:DSAMple <DeltaSample>

Sets the number of samples that are used for the calculation of the slope.

Parameters:

<DeltaSample>

POWER:SLEWrate:DTIME <DeltaTime>

Sets the delta time.

Parameters:

<DeltaTime>

POWER:SLEWrate:EXECute

Starts the slew rate measurement.

Usage: Event

POWER:SLEWrate:REPort:ADD

Adds the result to the report list.

Usage: Event

POWER:RIPple:RESult:FREQuency[:ACTual]?**POWER:RIPple:RESult:FREQuency:AVG?****POWER:RIPple:RESult:FREQuency:NPEak?****POWER:RIPple:RESult:FREQuency:PPEak?****POWER:RIPple:RESult:FREQuency:STDDev?****POWER:RIPple:RESult:FREQuency:WFMCOUNT?**

Returns the corresponding statistic result for the frequency.

- [:ACTual] : current measurement result
- AVG : average of the long-term measurement results
- NPEak : negative peak value of the long-term measurement results
- PPEak : positive peak value of the long-term measurement results
- STDDev : standard deviation of the long-term measurement results
- WFMCOUNT : the number of waveforms used for the displayed results

Return values:

<WaveformCount>

Usage: Query only

POWER:SLEWrate:RESult:LPEak[:ACTual]?**POWER:SLEWrate:RESult:LPEak:AVG?****POWER:SLEWrate:RESult:LPEak:NPEak?****POWER:SLEWrate:RESult:LPEak:PPEak?****POWER:SLEWrate:RESult:LPEak:STDDev?****POWER:SLEWrate:RESult:LPEak:WFMCOUNT?**

Returns the corresponding statistic result for "Vp-".

- [:ACTual] : current measurement result

- **AVG**: average of the long-term measurement results
- **NPEak**: negative peak value of the long-term measurement results
- **PPEak**: positive peak value of the long-term measurement results
- **STDDev**: standard deviation of the long-term measurement results
- **WFMCOUNT**: the number of waveforms used for the displayed results

Return values:

<WaveformCount>

Usage: Query only**POWER:RIPPLE:RESult:MEAN[:ACTual]?****POWER:RIPPLE:RESult:MEAN:AVG?****POWER:RIPPLE:RESult:MEAN:NPEak?****POWER:RIPPLE:RESult:MEAN:PPEak?****POWER:RIPPLE:RESult:MEAN:STDDev?****POWER:RIPPLE:RESult:MEAN:WFMCOUNT?**

Returns the corresponding statistic result for "Mean".

- **[:ACTual]**: current measurement result
- **AVG**: average of the long-term measurement results
- **NPEak**: negative peak value of the long-term measurement results
- **PPEak**: positive peak value of the long-term measurement results
- **STDDev**: standard deviation of the long-term measurement results
- **WFMCOUNT**: the number of waveforms used for the displayed results

Return values:

<WaveformCount>

Usage: Query only**POWER:RIPPLE:RESult:NDCYcle[:ACTual]?****POWER:RIPPLE:RESult:NDCYcle:AVG?****POWER:RIPPLE:RESult:NDCYcle:NPEak?****POWER:RIPPLE:RESult:NDCYcle:PPEak?****POWER:RIPPLE:RESult:NDCYcle:STDDev?****POWER:RIPPLE:RESult:NDCYcle:WFMCOUNT?**

Returns the corresponding statistic result for the negative duty cycle.

- **[:ACTual]**: current measurement result
- **AVG**: average of the long-term measurement results
- **NPEak**: negative peak value of the long-term measurement results
- **PPEak**: positive peak value of the long-term measurement results
- **STDDev**: standard deviation of the long-term measurement results
- **WFMCOUNT**: the number of waveforms used for the displayed results

Return values:

<WaveformCount>

Usage: Query only

POWER:RIPPLE:RESult:PDCYcle[:ACTual]?
POWER:RIPPLE:RESult:PDCYcle:AVG?
POWER:RIPPLE:RESult:PDCYcle:NPEak?
POWER:RIPPLE:RESult:PDCYcle:PPEak?
POWER:RIPPLE:RESult:PDCYcle:STDDev?
POWER:RIPPLE:RESult:PDCYcle:WFMCOUNT?

Returns the corresponding statistic result for the positive duty cycle.

- [:ACTual] : current measurement result
- AVG : average of the long-term measurement results
- NPEak : negative peak value of the long-term measurement results
- PPEak : positive peak value of the long-term measurement results
- STDDev : standard deviation of the long-term measurement results
- WFMCOUNT : the number of waveforms used for the displayed results

Return values:

<WaveformCount>

Usage: Query only

POWER:RIPPLE:RESult:PEAK[:ACTual]?
POWER:RIPPLE:RESult:PEAK:AVG?
POWER:RIPPLE:RESult:PEAK:NPEak?
POWER:RIPPLE:RESult:PEAK:PPEak?
POWER:RIPPLE:RESult:PEAK:STDDev?
POWER:RIPPLE:RESult:PEAK:WFMCOUNT?

Returns the corresponding statistic result for "Vpp".

- [:ACTual] : current measurement result
- AVG : average of the long-term measurement results
- NPEak : negative peak value of the long-term measurement results
- PPEak : positive peak value of the long-term measurement results
- STDDev : standard deviation of the long-term measurement results
- WFMCOUNT : the number of waveforms used for the displayed results

Return values:

<WaveformCount>

Usage: Query only

POWER:RIPPLE:RESult:PERiod[:ACTual]?
POWER:RIPPLE:RESult:PERiod:AVG?

POWer:RIPPlE:RESult:PERiod:NPEak?
POWer:RIPPlE:RESult:PERiod:PPEak?
POWer:RIPPlE:RESult:PERiod:STDDev?
POWer:RIPPlE:RESult:PERiod:WFMCCount?

Returns the corresponding statistic result for the period.

- [:ACTual] : current measurement result
- AVG : average of the long-term measurement results
- NPEak : negative peak value of the long-term measurement results
- PPEak : positive peak value of the long-term measurement results
- STDDev : standard deviation of the long-term measurement results
- WFMCCount : the number of waveforms used for the displayed results

Return values:

<WaveformCount>

Usage: Query only

POWer:RIPPlE:RESult:STDDev[:ACTual]?
POWer:RIPPlE:RESult:STDDev:AVG?
POWer:RIPPlE:RESult:STDDev:NPEak?
POWer:RIPPlE:RESult:STDDev:PPEak?
POWer:RIPPlE:RESult:STDDev:STDDev?
POWer:RIPPlE:RESult:STDDev:WFMCCount?

Returns the corresponding statistic result for the standard deviation.

- [:ACTual] : current measurement result
- AVG : average of the long-term measurement results
- NPEak : negative peak value of the long-term measurement results
- PPEak : positive peak value of the long-term measurement results
- STDDev : standard deviation of the long-term measurement results
- WFMCCount : the number of waveforms used for the displayed results

Return values:

<WaveformCount>

Usage: Query only

POWer:SLEWrate:RESult:UPEak[:ACTual]?
POWer:SLEWrate:RESult:UPEak:AVG?
POWer:SLEWrate:RESult:UPEak:NPEak?
POWer:SLEWrate:RESult:UPEak:PPEak?
POWer:SLEWrate:RESult:UPEak:STDDev?
POWer:SLEWrate:RESult:UPEak:WFMCCount?

Returns the corresponding statistic result for "Vp+".

- [:ACTual] : current measurement result

- **AVG**: average of the long-term measurement results
- **NPEak**: negative peak value of the long-term measurement results
- **PPEak**: positive peak value of the long-term measurement results
- **STDDev**: standard deviation of the long-term measurement results
- **WFMCOUNT**: the number of waveforms used for the displayed results

Return values:

<WaveformCount>

Usage: Query only**16.12.14 S.O.A**

| | |
|---|-----|
| POWER:SOA:EXECute..... | 721 |
| POWER:SOA:LINear:ADD..... | 721 |
| POWER:SOA:LOGarithmic:ADD..... | 721 |
| POWER:SOA:LINear:COUNT?..... | 721 |
| POWER:SOA:LOGarithmic:COUNT?..... | 721 |
| POWER:SOA:LINear:INSert..... | 721 |
| POWER:SOA:LOGarithmic:INSert..... | 721 |
| POWER:SOA:LINear:POINt<m>:CURRent..... | 722 |
| POWER:SOA:LOGarithmic:POINt<m>:CURRent..... | 722 |
| POWER:SOA:LINear:POINt<m>:CURRent:MAXimum..... | 722 |
| POWER:SOA:LOGarithmic:POINt<m>:CURRent:MAXimum..... | 722 |
| POWER:SOA:LINear:POINt<m>:CURRent:MINimum..... | 722 |
| POWER:SOA:LOGarithmic:POINt<m>:CURRent:MINimum..... | 722 |
| POWER:SOA:LINear:POINt<m>:VOLTage..... | 722 |
| POWER:SOA:LOGarithmic:POINt<m>:VOLTage..... | 722 |
| POWER:SOA:LINear:REMOve..... | 723 |
| POWER:SOA:LOGarithmic:REMOve..... | 723 |
| POWER:SOA:RESult:ACQuisition:FAILed?..... | 723 |
| POWER:SOA:RESult:ACQuisition:FRATe?..... | 723 |
| POWER:SOA:RESult:ACQuisition:PASSed?..... | 723 |
| POWER:SOA:RESult:ACQuisition:POINts?..... | 723 |
| POWER:SOA:RESult:ACQuisition:STATe?..... | 723 |
| POWER:SOA:RESult:ACQuisition:TOLerance..... | 724 |
| POWER:SOA:RESult:ACQuisition:VCOunt?..... | 724 |
| POWER:SOA:RESult:ACQuisition:VIOLation<n>?..... | 724 |
| POWER:SOA:RESult:ACQuisition:VIOLation<n>:CURRent?..... | 724 |
| POWER:SOA:RESult:TOTal:COUNT?..... | 724 |
| POWER:SOA:RESult:TOTal:FAILed?..... | 725 |
| POWER:SOA:RESult:TOTal:FRATe?..... | 725 |
| POWER:SOA:RESult:TOTal:PASSed?..... | 725 |
| POWER:SOA:RESult:TOTal:SAMPle:COUNT?..... | 725 |
| POWER:SOA:RESult:TOTal:SAMPle:FAILed?..... | 725 |
| POWER:SOA:RESult:TOTal:SAMPle:PASSed?..... | 725 |
| POWER:SOA:RESult:TOTal:STATe?..... | 726 |
| POWER:SOA:RESult:TOTal:TOLerance..... | 726 |
| POWER:SOA:RESult:TOTal:VCOunt?..... | 726 |

| | |
|--|-----|
| POWer:SOA:RESult:TOTal:VIOLation<n>?..... | 726 |
| POWer:SOA:RESult:TOTal:VIOLation<n>:CURRent?..... | 726 |
| POWer:SOA:RESult:TOTal:VIOLation<n>:VOLTage?..... | 726 |
| POWer:SOA:RESult:TOTal:VIOLation<n>:CURRent:DATA?..... | 727 |
| POWer:SOA:RESult:TOTal:VIOLation<n>:VOLTage:DATA?..... | 727 |
| POWer:SOA:RESult:TOTal:VIOLation<n>:CURRent:DATA:HEADer?..... | 727 |
| POWer:SOA:RESult:TOTal:VIOLation<n>:VOLTage:DATA:HEADer?..... | 727 |
| POWer:SOA:RESult:TOTal:VIOLation<n>:CURRent:DATA:XINCrement?..... | 727 |
| POWer:SOA:RESult:TOTal:VIOLation<n>:VOLTage:DATA:XINCrement?..... | 727 |
| POWer:SOA:RESult:TOTal:VIOLation<n>:CURRent:DATA:XORigin?..... | 727 |
| POWer:SOA:RESult:TOTal:VIOLation<n>:VOLTage:DATA:XORigin?..... | 727 |
| POWer:SOA:RESult:TOTal:VIOLation<n>:CURRent:DATA:YINCrement?..... | 727 |
| POWer:SOA:RESult:TOTal:VIOLation<n>:VOLTage:DATA:YINCrement?..... | 727 |
| POWer:SOA:RESult:TOTal:VIOLation<n>:CURRent:DATA:YORigin?..... | 728 |
| POWer:SOA:RESult:TOTal:VIOLation<n>:VOLTage:DATA:YORigin?..... | 728 |
| POWer:SOA:RESult:TOTal:VIOLation<n>:CURRent:DATA:YRESolution?..... | 728 |
| POWer:SOA:RESult:TOTal:VIOLation<n>:VOLTage:DATA:YRESolution?..... | 728 |
| POWer:SOA:REPort:ADD..... | 728 |
| POWer:SOA:REStart..... | 728 |
| POWer:SOA:SCALe..... | 728 |
| POWer:SOA:SCALe:DISPlay..... | 728 |
| POWer:SOA:SCALe:MASK..... | 728 |

POWer:SOA:EXECute

Starts the safe operating area (S.O.A.) measurement.

Usage: Event

POWer:SOA:LINear:ADD**POWer:SOA:LOGarithmic:ADD**

Adds a point to the safe operation area definition list.

Usage: Event

POWer:SOA:LINear:COUNT?**POWer:SOA:LOGarithmic:COUNT?**

Retruns the number of points.

Return values:

<PointsCount>

Usage: Query only

POWer:SOA:LINear:INSert <InsertIndex>**POWer:SOA:LOGarithmic:INSert <InsertIndex>**

Inserts a point with the selected insert index in the list of the safe operating area mask definition.

Setting parameters:

<InsertIndex>

Usage: Setting only

POWER:SOA:LINEar:POINT<m>:CURRENT <Current>**POWER:SOA:LOGarithmic:POINT<m>:CURRENT** <Current>

Sets the maximum current for the indicated mask point. The minimum current is set to 0.

Suffix:

<m> *
Index of the mask point

Parameters:

<Current> I_{max} value

POWER:SOA:LINEar:POINT<m>:CURRENT:MAXimum <MinimumCurrent>**POWER:SOA:LOGarithmic:POINT<m>:CURRENT:MAXimum** <MinimumCurrent>

Sets the maximum current for the corresponding point.

Suffix:

<m> *

Parameters:

<MinimumCurrent>

POWER:SOA:LINEar:POINT<m>:CURRENT:MINimum <MaximumCurrent>**POWER:SOA:LOGarithmic:POINT<m>:CURRENT:MINimum** <MaximumCurrent>

Sets the minimum current for the corresponding point.

Suffix:

<m> *

Parameters:

<MaximumCurrent>

POWER:SOA:LINEar:POINT<m>:VOLTage <Voltage>**POWER:SOA:LOGarithmic:POINT<m>:VOLTage** <Voltage>

Sets the voltage for the corresponding point.

Suffix:

<m> *

Parameters:

<Voltage>

POWER:SOA:LINEar:REMove <RemoveIndex>

POWER:SOA:LOGarithmic:REMove <RemoveIndex>

Removes the point with the selected index from the list of the safe operating area mask definition.

Setting parameters:

<RemoveIndex>

Usage: Setting only

POWER:SOA:RESult:ACQuisition:FAILED?

Returns the number of points that failed, i.e. they are not within the defined safe operating area.

Return values:

<FailedPoints>

Usage: Query only

POWER:SOA:RESult:ACQuisition:FRATe?

Returns the total point fail rate, i.e. the ratio of point hits to the number of tested points for the current acquisition.

Return values:

<FailRate>

Usage: Query only

POWER:SOA:RESult:ACQuisition:PASSED?

Returns the number of passed points, i.e. they are within the defined safe operating area.

Return values:

<PassedPoints>

Usage: Query only

POWER:SOA:RESult:ACQuisition:POINTs?

Returns the number of points, considered for the current acquisition.

Return values:

<Points>

Usage: Query only

POWER:SOA:RESult:ACQuisition:STATe?

Returns the result, passed or failed, of the current acquisition measurement.

Return values:

<AcquisitionState> 0 | 1

Usage: Query only

POWER:SOA:RESult:ACQquisition:TOLerance <Tolerance>

Sets acquisition tolerance in percent.

Parameters:

<Tolerance>

POWER:SOA:RESult:ACQquisition:VCOunt?

Returns the acquisition violation count.

Return values:

<ViolationCount>

Usage: Query only

POWER:SOA:RESult:ACQquisition:VIOLation<n>?

Returns the current and voltage value for the corresponding acquisition violation.

Return values:

<Current>

<Voltage>

Usage: Query only

POWER:SOA:RESult:ACQquisition:VIOLation<n>:CURRent?

Returns the current value for the corresponding acquisition violation point.

Suffix:

<n> *

Return values:

<Current>

Usage: Query only

POWER:SOA:RESult:TOTal:COUnT?

Returns the total number of acquisitions used to determine the total result.

Return values:

<AcquisitionCount>

Usage: Query only

POWER:SOA:RESult:TOTal:FAILed?

Returns the total number of failed acquisitions, i.e they are not within the defined safe operating area.

Return values:

<FailedAcquisitions>

Usage: Query only

POWER:SOA:RESult:TOTal:FRATe?

Returns the total acquisition fail rate, i.e the ratio of acquisition hits to the number of tested acquisitions.

Return values:

<FailRate>

Usage: Query only

POWER:SOA:RESult:TOTal:PASSed?

Returns the number of passed acquisitions, i.e they are within the defined safe operating area.

Return values:

<PassedAcquisitions>

Usage: Query only

POWER:SOA:RESult:TOTal:SAMPle:COUNT?

Returns the total number of samples used to determine the total result.

Usage: Query only

POWER:SOA:RESult:TOTal:SAMPle:FAILed?

Returns the total number of failed samples, i.e they are not within the defined safe operating area.

Usage: Query only

POWER:SOA:RESult:TOTal:SAMPle:PASSed?

Returns the number of passed samples, i.e they are within the defined safe operating area.

Usage: Query only

POWER:SOA:RESult:TOTal:STATe?

Returns the result, passed or failed, of the total measurement.

Return values:

<TotalState> 0 | 1

Usage: Query only

POWER:SOA:RESult:TOTal:TOLerance <Tolerance>

Returns the tolerance of the total measurement.

Parameters:

<Tolerance>

POWER:SOA:RESult:TOTal:VCOunt?

Returns the acquisition violation count.

Return values:

<ViolationCount>

Usage: Query only

POWER:SOA:RESult:TOTal:VIOLation<n>?

Returns the current and voltage value for the corresponding total violation.

Return values:

<Current>

<Voltage>

Usage: Query only

POWER:SOA:RESult:TOTal:VIOLation<n>:CURRent?**POWER:SOA:RESult:TOTal:VIOLation<n>:VOLTage?**

Returns the voltage of the total violation.

Suffix:

<n> *

Return values:

<Voltage>

Usage: Query only

POWER:SOA:RESult:TOTal:VIOLation<n>:CURRent:DATA?

POWER:SOA:RESult:TOTal:VIOLation<n>:VOLTage:DATA?

Returns the data of the total voltage violation waveform in the same way as [CHANnel<m>:DATA?](#).

Return values:

<Header> StringData

Usage: Query only

POWER:SOA:RESult:TOTal:VIOLation<n>:CURRent:DATA:HEADer?

POWER:SOA:RESult:TOTal:VIOLation<n>:VOLTage:DATA:HEADer?

Returns information on the total violation current.

Return values:

<Header> StringData

Usage: Query only

POWER:SOA:RESult:TOTal:VIOLation<n>:CURRent:DATA:XINCrement?

POWER:SOA:RESult:TOTal:VIOLation<n>:VOLTage:DATA:XINCrement?

Return the time difference between two adjacent samples of the indicated waveform.

Return values:

<Xincrement>

Usage: Query only

POWER:SOA:RESult:TOTal:VIOLation<n>:CURRent:DATA:XORigin?

POWER:SOA:RESult:TOTal:VIOLation<n>:VOLTage:DATA:XORigin?

Return the time of the first sample of the indicated waveform.

Return values:

<Xorigin>

Usage: Query only

POWER:SOA:RESult:TOTal:VIOLation<n>:CURRent:DATA:YINCrement?

POWER:SOA:RESult:TOTal:VIOLation<n>:VOLTage:DATA:YINCrement?

Return the voltage value per bit of the indicated waveform.

Return values:

<Yincrement>

Usage: Query only

POWer:SOA:RESult:TOTal:VIOLation<n>:CURRent:DATA:YORigin?

POWer:SOA:RESult:TOTal:VIOLation<n>:VOLTage:DATA:YORigin?

Return the voltage value for binary value 0 of the indicated waveform.

Return values:

<Yorigin>

Usage: Query only

POWer:SOA:RESult:TOTal:VIOLation<n>:CURRent:DATA:YRESolution?

POWer:SOA:RESult:TOTal:VIOLation<n>:VOLTage:DATA:YRESolution?

POWer:SOA:REPort:ADD

POWer:SOA:REStart

POWer:SOA:SCALe <>

POWer:SOA:SCALe:DISPlay <>

POWer:SOA:SCALe:MASK <>

Sets the scale for the mask, linear or logarithmic.

16.12.15 Spectrum

| | |
|---|-----|
| POWer:SPECtrum:EXECute | 728 |
| POWer:SPECtrum:FREQuency | 728 |
| POWer:SPECtrum:REPort:ADD | 729 |
| POWer:SPECtrum:RESult<n>:FREQuency? | 729 |
| POWer:SPECtrum:RESult<n>:LEVel[:VALue]? | 729 |
| POWer:SPECtrum:RESult<n>:MAXimum? | 729 |
| POWer:SPECtrum:RESult<n>:MEAN? | 729 |
| POWer:SPECtrum:RESult<n>:MINimum? | 730 |
| POWer:SPECtrum:RESult<n>:RESet | 730 |
| POWer:SPECtrum:RESult<n>:WFMCount? | 730 |
| EXPort:POWer:NAME | 730 |
| EXPort:POWer:SAVE | 730 |

POWer:SPECtrum:EXECute

Starts the spectrum measurement.

Usage: Event

POWer:SPECtrum:FREQuency <SwitchingFrequency>

Sets the frequency of the input signal.

Parameters:

<SwitchingFrequency>

POWER:SPECTrum:REPort:ADD

Adds the result to the report list.

Usage: Event

POWER:SPECTrum:RESult<n>:FREQuency?

Queries the frequency of the n-th order.

Suffix:

<n> 1..40

Return values:

<FrequencyValue>

Usage: Query only

POWER:SPECTrum:RESult<n>:LEVel[:VALue]?

Queries the level of the n-th order.

Suffix:

<n> 1..40

Return values:

<LevelValue>

Usage: Query only

POWER:SPECTrum:RESult<n>:MAXimum?

Queries the maximum level of the n-th order.

Suffix:

<n> 1..40

Return values:

<LevelMaximum>

Usage: Query only

POWER:SPECTrum:RESult<n>:MEAN?

Queries the average level of the n-th order.

Suffix:

<n> 1..40

Return values:

<LevelAverage>

Usage: Query only

POWER:SPECTrum:RESult<n>:MINimum?

Queries the minimum level of the n-th order.

Suffix:

<n> 1..40

Return values:

<LevelMinimum>

Usage: Query only

POWER:SPECTrum:RESult<n>:RESet

Resets the count of the measurements.

Suffix:

<n> 1..40

Usage: Event

POWER:SPECTrum:RESult<n>:WFMCount?

Queries the number of waveforms, for which the spectrum was measured.

Suffix:

<n> 1..40

Return values:

<WaveformCount>

Usage: Query only

EXPort:POWER:NAME <ExportPath>

Defines the path and filename for results of harmonics and spectrum power measurements. Results are saved with `EXPort:POWER:SAVE`. The file format is CSV, the filename is incremented automatically.

Parameters:

<ExportPath> String parameter

EXPort:POWER:SAVE

Saves the harmonics and spectrum measurement results to the path and file defined by `EXPort:POWER:NAME`.

Usage: Event

16.12.16 Switching

| | |
|---|-----|
| POWer:SWITChing:EXECute..... | 731 |
| POWer:SWITChing:GATE:CONDUction:START..... | 731 |
| POWer:SWITChing:GATE:CONDUction:STOP..... | 731 |
| POWer:SWITChing:GATE:NCONDUction:START..... | 732 |
| POWer:SWITChing:GATE:NCONDUction:STOP..... | 732 |
| POWer:SWITChing:GATE:SWAVe..... | 732 |
| POWer:SWITChing:GATE:TOFF:START..... | 732 |
| POWer:SWITChing:GATE:TOFF:STOP..... | 732 |
| POWer:SWITChing:GATE:TON:START..... | 732 |
| POWer:SWITChing:GATE:TON:STOP..... | 732 |
| POWer:SWITChing:REPort:ADD..... | 733 |
| POWer:SWITChing:RESult:CONDUction:ENERgy?..... | 733 |
| POWer:SWITChing:RESult:CONDUction:POWer?..... | 733 |
| POWer:SWITChing:RESult:NCONDUction:ENERgy?..... | 733 |
| POWer:SWITChing:RESult:NCONDUction:POWer?..... | 733 |
| POWer:SWITChing:RESult:TOFF:ENERgy?..... | 733 |
| POWer:SWITChing:RESult:TOFF:POWer?..... | 734 |
| POWer:SWITChing:RESult:TON:ENERgy?..... | 734 |
| POWer:SWITChing:RESult:TON:POWer?..... | 734 |
| POWer:SWITChing:RESult:TOTal:ENERgy?..... | 734 |
| POWer:SWITChing:RESult:TOTal:POWer?..... | 734 |
| POWer:SWITChing:TYPE..... | 734 |

POWer:SWITChing:EXECute

Starts the switching loss measurement.

Usage: Event

POWer:SWITChing:GATE:CONDUction:START <StartTime>

Sets the start time for the conduction gate. This value is simultaneously the stop time for the turn on gate.

Parameters:

<StartTime>

POWer:SWITChing:GATE:CONDUction:STOP <StopTime>

Sets the stop time for the conduction gate. This value is simultaneously the start time for the turn off gate.

Parameters:

<StopTime>

POWER:SWITChing:GATE:NCONduction:START <StartTime>

Sets the start time for the non conduction gate. This value is simultaneously the stop time for the turn off gate.

Parameters:

<StartTime>

POWER:SWITChing:GATE:NCONduction:STOP <StopTime>

Sets the cursor on the waveform.

Parameters:

<StopTime>

POWER:SWITChing:GATE:SWAVe

Sets the cursor on the waveform.

Usage: Event

POWER:SWITChing:GATE:TOFF:START <StartTime>

Sets the start time for the turn off gate. This value is simultaneously the stop time for the conduction gate.

Parameters:

<StartTime>

POWER:SWITChing:GATE:TOFF:STOP <StopTime>

Sets the stop time for the turn off gate.

Parameters:

<StopTime>

POWER:SWITChing:GATE:TON:START <StartTime>

Sets the start time for the turn on gate.

Parameters:

<StartTime>

POWER:SWITChing:GATE:TON:STOP <StopTime>

Sets the stop time for the turn on gate.

Parameters:

<StopTime>

POWer:SWITching:REPort:ADD

Adds the result to the report list.

Usage: Event

POWer:SWITching:RESult:CONduction:ENERgy?

Queries the conduction energy.

Return values:

<ConductionEnergy>

Usage: Query only

POWer:SWITching:RESult:CONduction:POWer?

Queries the conduction power.

Return values:

<ConductionPower>

Usage: Query only

POWer:SWITching:RESult:NCONduction:ENERgy?

Queries the non conduction energy.

Return values:

<NonConductionEnergy>

Usage: Query only

POWer:SWITching:RESult:NCONduction:POWer?

Queries the non conduction power.

Return values:

<NonConductionPower>

Usage: Query only

POWer:SWITching:RESult:TOFF:ENERgy?

Queries the turn off energy.

Return values:

<TurnOffEnergy>

Usage: Query only

POWer:SWITching:RESult:TOFF:POWer?

Queries the turn off power.

Return values:

<TurnOffPower>

Usage: Query only

POWer:SWITching:RESult:TON:ENERgy?

Queries the turn on energy.

Return values:

<TurnOnEnergy>

Usage: Query only

POWer:SWITching:RESult:TON:POWer?

Queries the turn on power.

Return values:

<TurnOnPower>

Usage: Query only

POWer:SWITching:RESult:TOTal:ENERgy?

Queries the total energy.

Return values:

<TotalEnergy>

Usage: Query only

POWer:SWITching:RESult:TOTal:POWer?

Queries the total power.

Return values:

<TotalPower>

Usage: Query only

POWer:SWITching:TYPE <MeasureType>

Sets the measurement type for the switching loss measurement.

Parameters:

<MeasureType> ENERgy | POWer

16.12.17 Transient Response

| | |
|---|-----|
| POWer:TRANsient:EXECute..... | 735 |
| POWer:TRANsient:REPort:ADD..... | 735 |
| POWer:TRANsient:RESult:DELay?..... | 735 |
| POWer:TRANsient:RESult:OVERshoot?..... | 735 |
| POWer:TRANsient:RESult:PEAK:TIME?..... | 735 |
| POWer:TRANsient:RESult:PEAK:VALue?..... | 736 |
| POWer:TRANsient:RESult:RTIME?..... | 736 |
| POWer:TRANsient:RESult:SETTlingtime?..... | 736 |
| POWer:TRANsient:SIGHigh..... | 736 |
| POWer:TRANsient:SIGLow..... | 736 |
| POWer:TRANsient:START..... | 736 |
| POWer:TRANsient:STOP..... | 737 |

POWer:TRANsient:EXECute

Starts the transient response measurement.

Usage: Event

POWer:TRANsient:REPort:ADD

Adds the result to the report list.

Usage: Event

POWer:TRANsient:RESult:DELay?

Queries the delay time.

Return values:

<DeleayTime>

Usage: Query only

POWer:TRANsient:RESult:OVERshoot?

Queries the overshoot.

Return values:

<Overshoot>

Usage: Query only

POWer:TRANsient:RESult:PEAK:TIME?

Queries the peak time.

Return values:

<PeakTime>

Usage: Query only

POWer:TRANsient:RESult:PEAK:VALue?

Queries the peak value.

Return values:

<PeakValue>

Usage: Query only

POWer:TRANsient:RESult:RTIME?

Queries the rise time.

Return values:

<RiseTime>

Usage: Query only

POWer:TRANsient:RESult:SETTlingtime?

Queries the settling time.

Return values:

<SettlingTime>

Usage: Query only

POWer:TRANsient:SIGHigh <SignalHigh>

Sets the expected signal high voltage value.

Parameters:

<SignalHigh>

POWer:TRANsient:SIGLow <SignalLow>

Sets the expected signal low voltage value.

Parameters:

<SignalLow>

POWer:TRANsient:STARt <StartTime>

Sets the start time for the transient response measurement.

Parameters:

<StartTime>

POWER:TRANSient:STOP <StopTime>

Sets the stop time for the transient response measurement.

Parameters:

<StopTime>

16.13 Mixed Signal Option (Option R&S RTM-B1)

- [Logic Channels](#)..... 737
- [Parallel Buses](#)..... 744

16.13.1 Logic Channels

Two different sets of commands are described in this chapter:

- `LOGic<p>:xxx:xxx:`
Refer to the logic pod 1 ("D7...D0") or logic pod 2 ("D8...D15"). The suffix <p> selects the logic pod, range 1..2.
- `DIGital<m>:xxx:xxx:`
Refer to a specific logic channel. The suffix <m> selects the logic channel, range 0..15.

- [Logic Channels - Activity Display](#)..... 737
- [Logic Analyzer Configuration](#)..... 738
- [Logic Channels - Waveform Data](#)..... 741

16.13.1.1 Logic Channels - Activity Display

| | |
|--|-----|
| <code>LOGic<p>:PROBe[:ENABLE]?</code> | 737 |
| <code>LOGic<p>:CURRent:STATe:MAXimum?</code> | 738 |
| <code>DIGital<m>:CURRent:STATe:MAXimum?</code> | 738 |
| <code>LOGic<p>:CURRent:STATe:MINimum?</code> | 738 |
| <code>DIGital<m>:CURRent:STATe:MINimum?</code> | 738 |

LOGic<p>:PROBe[:ENABLE]?

Checks if the logic probe is connected.

Suffix:

<p> 1..2
Selects the pod.

Return values:

<ProbeEnable> 1 | 0
1 = connected, 0 = not connected

Usage: Query only

LOGic<p>:CURRent:STATe:MAXimum?
DIGital<m>:CURRent:STATe:MAXimum?
LOGic<p>:CURRent:STATe:MINimum?
DIGital<m>:CURRent:STATe:MINimum?

Both commands together return the current status of the indicated logic channel/pod regardless of the trigger settings, and even without any acquisition.

| xxx:CURR:STAT:MIN returns | xxx:CURR:STAT:MAX returns | Signal |
|---------------------------|---------------------------|--------|
| 0 | 0 | Low |
| 1 | 1 | High |
| 0 | 1 | Toggle |

Suffix:

<m> 0..15
 Selects the logic channel

<p> 1..2
 Selects the logic pod

Return values:

<CurrentState> Range: 0 | 1

Usage:

Query only

16.13.1.2 Logic Analyzer Configuration

LOGic<p>:STATe..... 738
 DIGital<m>:DISPlay..... 739
 DIGital<m>:TECHnology..... 739
 DIGital<m>:THCoupling..... 739
 DIGital<m>:THReshold..... 739
 DIGital<m>:HYSTeresis..... 740
 DIGital<m>:DESKew..... 740
 DIGital<m>:SIZE..... 740
 DIGital<m>:POSition..... 741
 DIGital<m>:LABel..... 741
 DIGital<m>:LABel:STATe..... 741

LOGic<p>:STATe

Switches the logic pod on or off.

Suffix:

<p> 1..2
 Selects the logic pod

Parameters:

<State> ON | OFF
 *RST: OFF

DIGital<m>:DISPlay <State>

Enables and displays the indicated logic channel, or disables it.

Suffix:

<m> 0..15
Number of the logic channel

Parameters:

<State> ON | OFF
*RST: OFF

DIGital<m>:TECHnology <ThresholdMode>

Selects the threshold voltage for various types of integrated circuits and applies it to the channel group to which the indicated logic channel belongs.

Suffix:

<m> 0..15
Number of the logic channel

Parameters:

<ThresholdMode> TTL | ECL | CMOS | MANual
TTL: 1.4 V
ECL: -1.3 V
CMOS: 2.5 V
MANual: Set a user-defined threshold value with [DIGital<m>:THReshold](#)
*RST: MAN

DIGital<m>:THCoupling <ThresholdCoupling>

Sets all threshold and hysteresis values to the values of the first nibble (D0...D3).

Suffix:

<m> 0..15
The suffix is irrelevant.

Parameters:

<ThresholdCoupling> ON | OFF
*RST: ON

DIGital<m>:THReshold <ThresholdLevel>

Sets the logical threshold for the nibble (D0...D3, D4...D7, D8...D11, and D12...D15) to which the indicated logic channel belongs.

Suffix:

<m> 0..15
Number of the logic channel

Parameters:

<ThresholdLevel> *RST: 1.4
Default unit: V

DIGital<m>:HYSTeresis <Hysteresis>

Defines the size of the hysteresis to avoid the change of signal states due to noise. The setting applies to the logic pod to which the indicated logic channel belongs.

Suffix:

<m> 0..15
Selects the logic channel.

<p> 1..2
Selects the logic pod.

Parameters:

<Hysteresis> SMAL | MEDium | LARGe

DIGital<m>:DESKew <Deskew>

Sets the deskew value for the pod to which the specified logic channel belongs. The deskew value compensates delays that are known from the circuit specifics or caused by the different length of cables. The skew between the probe boxes of the digital channels and the probe connectors of the analog channels is automatically aligned by the instrument.

Suffix:

<m> 0..15
Number of the logic channel. Each pod (D0...D7 and D8...D15) has a common deskew.

Parameters:

<Deskew> *RST: 0
Default unit: s

DIGital<m>:SIZE <Size>

Sets the vertical size of the indicated digital channel.

Suffix:

<m> 0..15
Number of the logic channel

Parameters:

<Size> Specifies the number of divisions per logic channel.
Range: 0.2 to 8
Increment: 0.1
*RST: 0.3
Default unit: DIV

DIGital<m>:POSition <Position>

Sets the vertical position of the indicated vertical channel.

Suffix:

<m> 0..15
 Number of the logic channel

Parameters:

<Position> Vertical position in divisions
 Default unit: DIV

DIGital<m>:LABel <Label>

Defines a label for the indicated logic channel.

Suffix:

<m> 0..15
 Number of the logic channel

Parameters:

<Label> String value
 String parameter

Example:

DIGital4:LABel "Data"
Defines the label "Data" for logic channel D4.

DIGital<m>:LABel:STATe <State>

Displays or hides the label of the indicated logic channel.

Suffix:

<m> 0..15
 Number of the logic channel

Parameters:

<State> ON | OFF
 *RST: OFF

16.13.1.3 Logic Channels - Waveform Data

For data queries and conversion, consider also the following commands:

- [FORMat\[:DATA\]](#) on page 539
- [DIGital<m>:DATA:XINCrement?](#) on page 549
- [DIGital<m>:DATA:XORigin?](#) on page 548
- [DIGital<m>:DATA:YINCrement?](#) on page 550
- [DIGital<m>:DATA:YORigin?](#) on page 549
- [DIGital<m>:DATA:YRESolution?](#) on page 550
- [LOGic<p>:DATA:XINCrement?](#) on page 549

- LOGic<p>:DATA:XORigin? on page 548
- LOGic<p>:DATA:YINCrement? on page 550
- LOGic<p>:DATA:YORigin? on page 549
- LOGic<p>:DATA:YRESolution? on page 550

LOGic<p>:DATA?.....742
 DIGital<m>:DATA?.....742
 LOGic<p>:DATA:HEADer?.....742
 DIGital<m>:DATA:HEADer?.....742
 LOGic<p>:DATA:POINts.....743
 DIGital<m>:DATA:POINts.....743

LOGic<p>:DATA?
DIGital<m>:DATA?

Returns the data of the specified logic channel/pod for transmission from the instrument to the controlling computer. The waveforms data can be used in MATLAB, for example.

To set the export format, use `FORMat [:DATA]`.

To set the range of samples to be returned, use `DIGital<m>:DATA:POINts`.

Suffix:

- <m> 0..15
Selects the logic channel
- <p> 1..2
Selects the logic pod

Parameters:

<WaveformData> List of values according to the format settings.

Example:

```
FORM ASC,0
DIG1:DATA?
1,1,1,1,1,1,0,0,0,0,0,0,...
```

Usage: Query only

LOGic<p>:DATA:HEADer?
DIGital<m>:DATA:HEADer?

Returns information on the waveform of the specified logic channel/pod.

Table 16-6: Header data

| Position | Meaning | Example |
|----------|--|--------------------------|
| 1 | XStart in s | -9.477E-008 = - 94,77 ns |
| 2 | XStop in s | 9.477E-008 = 94,77 ns |
| 3 | Record length of the waveform in Samples | 200000 |
| 4 | Number of values per sample interval, usually 1. | 1 |

Suffix:

<m> 0..15
Selects the logic channel

<p> 1..2
Selects the logic pod

Parameters:

<Header> Comma-separated value list
Example: -9.477E-008,9.477E-008,200000,1

Usage: Query only

LOGic<p>:DATA:POINts <PointSelection>

DIGital<m>:DATA:POINts <PointSelection>

As a setting, the command selects a range of samples that will be returned with `DIGital<m>:DATA?`. As a query, it returns the number of returned samples for the selected range.

Depending on the current settings, the memory can contain more data samples than the screen is able to display. In this case, you can decide which data will be saved: samples stored in the memory or only the displayed samples.

Note: The sample range can be changed only in STOP mode. If the acquisition is running, DEF is always used automatically. If the acquisition has been stopped, data can be read from the memory, and all settings are available.

Suffix:

<m> 0..15
Selects the logic channel

<p> 1..2
Selects the logic pod

Setting parameters:

<PointSelection> DEFault | MAXimum | DMAXimum
Sets the range for data queries.

DEFault

Waveform points that are visible on the screen. At maximum waveform rate, the instrument stores more samples than visible on the screen, and DEF returns less values than acquired.

MAXimum

All waveform samples that are stored in the memory. Only available if acquisition is stopped.

DMAXimum

Display maximum: Waveform samples stored in the current waveform record but only for the displayed time range. At maximum waveform rate, the instrument stores more samples than visible on the screen, and DMAX returns more values than DEF. Only available if acquisition is stopped.

*RST: DEFault

Return values:

<Points> Number of data points in the selected range.
 Default unit: Samples

See also: [CHANnel<m>:DATA:POINTs](#)

16.13.2 Parallel Buses

- [Parallel Bus - Line Configuration](#).....744
- [Parallel Clocked Bus Configuration](#).....745
- [Parallel Buses - Decode Results](#).....746

16.13.2.1 Parallel Bus - Line Configuration

BUS:PARAllel:WIDTh <BusWidth>

Sets the number of lines to be analyzed for the parallel bus.

Suffix:

 1..2
 Selects the parallel bus.

Parameters:

<BusWidth> Maximum number is the number of input channels.
 Range: 1 to 4
 Increment: 1
 *RST: 4
 Default unit: Bit

BUS:CPARAllel:WIDTh <BusWidth>

Sets the number of lines to be analyzed for the parallel clocked bus.

Suffix:

 1..2
 Selects the parallel bus.

Parameters:

<BusWidth> Range: 1 to 15 (clock only) or 14 (clock and CS)
 Increment: 1
 *RST: 4
 Default unit: Bit

BUS:PARAllel:DATA<m>:SOURce <DataSource>**BUS:CPARAllel:DATA<m>:SOURce <DataSource>**

Defines the logic channel that is assigned to the selected bit.

Use the command for each bit of the bus.

Suffix:

 1..2
Selects the parallel bus.

<m> Sets the bit number.

Parameters:

<DataSource> D0..D15

Example:

```
BUS:PARAllel:Width 4
BUS:PARAllel:DATA0:SOURce D8
BUS:PARAllel:DATA1:SOURce D9
BUS:PARAllel:DATA2:SOURce D10
BUS:PARAllel:DATA3:SOURce D11
```

16.13.2.2 Parallel Clocked Bus Configuration

| | |
|------------------------------------|-----|
| BUS:CPARAllel:CLOCK:SOURce..... | 745 |
| BUS:CPARAllel:CLOCK:SLOPe..... | 745 |
| BUS:CPARAllel:CS:ENABle..... | 745 |
| BUS:CPARAllel:CS:SOURce..... | 746 |
| BUS:CPARAllel:CS:POLarity..... | 746 |

BUS:CPARAllel:CLOCK:SOURce <ClockSource>

Selects the logic channel that is used as clock line.

Suffix:

 1..2
Selects the parallel bus.

Parameters:

<ClockSource> D0..D15
*RST: D0

BUS:CPARAllel:CLOCK:SLOPe <ClockSlope>

Selects if the data is sampled on the rising or falling slope of the clock, or on both edges (EITHer). The clock slope marks the begin of a new bit.

Suffix:

 1..2
Selects the parallel bus.

Parameters:

<ClockSlope> POSitive | NEGative | EITHer

BUS:CPARAllel:CS:ENABle <ChipSelectEnable>

Enables and disables the chip select line.

Suffix:

 1..2
Selects the parallel bus.

Parameters:

<ChipSelectEnable> ON | OFF
*RST: ON

BUS:CPARAllel:CS:SOURCe <ChipSelectSource>

Selects the logic channel that is used as chip select line.

Suffix:

 1..2
Selects the parallel bus.

Parameters:

<ChipSelectSource> D0..D15
*RST: D1

BUS:CPARAllel:CS:POLArity <Polarity>

Selects if the chip select signal is high active (high = 1) or low active (low = 1).

Suffix:

 1..2
Selects the parallel bus.

Parameters:

<Polarity> POSitive | NEGative
POSitive = high active
NEGative = low active

16.13.2.3 Parallel Buses - Decode Results

The commands to query results of decoded parallel clocked and unlocked buses are similar and described together in this chapter..

| | |
|---------------------------------------|-----|
| BUS:PARAllel:FCOunt?..... | 747 |
| BUS:CPARAllel:FCOunt?..... | 747 |
| BUS:PARAllel:FRAMe<n>:DATA?..... | 747 |
| BUS:CPARAllel:FRAMe<n>:DATA?..... | 747 |
| BUS:PARAllel:FRAMe<n>:STATe?..... | 747 |
| BUS:CPARAllel:FRAMe<n>:STATe?..... | 747 |
| BUS:PARAllel:FRAMe<n>:START?..... | 747 |
| BUS:CPARAllel:FRAMe<n>:START?..... | 747 |
| BUS:PARAllel:FRAMe<n>:STOP?..... | 748 |
| BUS:CPARAllel:FRAMe<n>:STOP?..... | 748 |

BUS:PARAllel:FCOunt?**BUS:CPARAllel:FCOunt?**

Returns the number of decoded frames.

Suffix:

 1..2
Selects the parallel bus.

Return values:

<FrameCount> Total number of decoded frames.

Usage: Query only

BUS:PARAllel:FRAMe<n>:DATA?**BUS:CPARAllel:FRAMe<n>:DATA?**

Returns the data words of the specified frame.

Suffix:

 1..2
Selects the parallel bus.

<n> *
Selects the frame.

Return values:

<FrameData> List of decimal values of data words

Usage: Query only

BUS:PARAllel:FRAMe<n>:STATe?**BUS:CPARAllel:FRAMe<n>:STATe?**

Returns the overall state of the specified frame.

Suffix:

 1..2
Selects the parallel bus.

<n> *
Selects the frame.

Return values:

<FrameStatus> OK | ERRor | INSufficient

Usage: Query only

BUS:PARAllel:FRAMe<n>:START?**BUS:CPARAllel:FRAMe<n>:START?**

Returns the start time of the specified frame.

Suffix:

 1..2
Selects the parallel bus.

<n> *
Selects the frame.

Return values:

<StartTime> Default unit: s

Usage: Query only

BUS:PARAllel:FRAMe<n>:STOP?**BUS:CPARAllel:FRAMe<n>:STOP?**

Returns the end time of the specified frame.

Suffix:

 1..2
Selects the parallel bus.

<n> *
Selects the frame.

Return values:

<StopTime> Default unit: s

Usage: Query only

16.14 Signal Generation (Option R&S RTM-B6)

16.14.1 Function Generator

16.14.1.1 Basic Settings of the Function Generator

| | |
|---|-----|
| WGENerator:FUNctIon..... | 749 |
| WGENerator:VOLtAge..... | 749 |
| WGENerator:VOLtAge:OFFSet..... | 749 |
| WGENerator:FREQuency..... | 749 |
| WGENerator:FUNctIon:PULSe:DCYCLe..... | 749 |
| WGENerator:TRlangle:SYMMetry..... | 750 |
| WGENerator:FUNctIon:PULSe:ETIME..... | 750 |
| WGENerator:FUNctIon:EXPOntial:POLarity..... | 750 |
| WGENerator:FUNctIon:RAMP:POLarity..... | 750 |
| WGENerator:NOISe:ABSolute..... | 750 |
| WGENerator:NOISe:RELative..... | 750 |
| WGENerator:OUTPut:LOAD..... | 751 |
| WGENerator:OUTPut[:ENABLE]..... | 751 |

WGENerator:FUNction <Function>

Selects the function to be generated.

Parameters:

<Function> DC | SINusoid | SQUare | PULSe | TRIangle | RAMP | SINC |
ARBitrary | EXPonential

WGENerator:VOLTage <Amplitude>

Defines the amplitude value (peak-to-peak value) of the selected generator function.

Parameters:

<Amplitude> Numeric value
Range: 6.0000E-02 to 6.00000E+00
*RST: 5.0000E-01
Default unit: Vpp

WGENerator:VOLTage:OFFSet <Offset>

Sets the DC offset of the selected generator function.

Parameters:

<Offset> Numeric value
Range: -3.00000E+00 to 3.00000E+00
*RST: 0.00E+00
Default unit: V

WGENerator:FREQUency <Frequency>

Defines the frequency.

Parameters:

<Frequency> Range: Depends on the selected function. For details, refer
to the datasheet.
*RST: 10 kHz

WGENerator:FUNction:PULSe:DCYCLE <DutyCycle>

Defines the duty cycle value of the generator function pulse.

Parameters:

<DutyCycle> Numeric value
Range: 1.000E+01 to 9.000E+01
*RST: 2.500E+01
Default unit: %

WGENerator:TRiangle:SYMMetry <Symmetry>

Sets the symmetry for the triangle waveform.

Parameters:

<Symmetry> 50% defines symmetric triangles. Values <50% define triangles with steeper rising edge leaned to the left. Values >50% define triangles with steeper falling edge leaned to the right.

Range: 1 to 99
Increment: 1
*RST: 50
Default unit: %

WGENerator:FUNCTion:PULSe:ETIme <EdgeTime>

Sets the pulse edge time.

Parameters:

<EdgeTime>

WGENerator:FUNCTion:EXPonential:POLarity <Polarity>

Sets the polarity of the generator function exponential.

Parameters:

<Polarity> POSitive | NEGative

WGENerator:FUNCTion:RAMP:POLarity <Polarity>

Sets the polarity of the generator function ramp.

Parameters:

<Polarity> POSitive | NEGative
*RST: NEG

WGENerator:NOISe:ABSolute <AbsoluteNoise>

Sets the noise of the waveform in volts.

Parameters:

<AbsoluteNoise>

WGENerator:NOISe:RELative <RelativeNoise>

Sets the noise of the generated waveform in percentage of the amplitude.

Parameters:

<RelativeNoise>

WGENerator:OUTPut:LOAD <Load>

Select the user load, the load of the DUT at its connection. You can select either a "50Ω" or a "High-Z" (high input impedance) load.

Parameters:

<Load> HIGHz | R50

WGENerator:OUTPut[:ENABle] <OutputEnable>

Enables the function generator and outputs the waveform.

Parameters:

<OutputEnable> ON | OFF

16.14.1.2 Arbitrary Waveform Setup

| | |
|---------------------------------------|-----|
| WGENerator:ARBitrary:SOURce..... | 751 |
| WGENerator:ARBitrary:RANGe:START..... | 751 |
| WGENerator:ARBitrary:RANGe:STOP..... | 751 |
| WGENerator:ARBitrary:UPDate..... | 752 |
| WGENerator:ARBitrary[:FILE]:NAME..... | 752 |
| WGENerator:ARBitrary[:FILE]:OPEN..... | 752 |
| WGENerator:ARBitrary:VISible..... | 752 |

WGENerator:ARBitrary:SOURce <Source>

Selects the input channel for an arbitrary function to be generated.

Parameters:

<Source> CH1 | CH2 | CH3 | CH4
*RST: CH1

WGENerator:ARBitrary:RANGe:START <StartTime>

Sets the start time of the copied waveform part.

Parameters:

<StartTime> Default unit: s

WGENerator:ARBitrary:RANGe:STOP <StopTime>

Sets the end time of the copied waveform part.

Parameters:

<StopTime> Default unit: s

WGENerator:ARbitrary:UPDate

Loads the waveform from the selected signal source ([WGENerator:ARbitrary:SOURce](#)).

Usage: Event

WGENerator:ARbitrary[:FILE]:NAME <FilePath>

Sets the file path and the file for an arbitrary waveform to be loaded.

Parameters:

<FilePath> string
*RST: "

WGENerator:ARbitrary[:FILE]:OPEN

Loads the arbitrary waveform, that is selected with the [WGENerator:ARbitrary\[:FILE\]:NAME](#) command.

Usage: Event

WGENerator:ARbitrary:VISible <ArbWaveformVisible>

Enables the display of the arbitrary waveform.

Parameters:

<ArbWaveformVisible>ON | OFF
*RST: OFF

16.14.1.3 Burst Settings

| | |
|--|-----|
| WGENerator:BURSt:ITIME | 752 |
| WGENerator:BURSt:NCYCLe | 752 |
| WGENerator:BURSt:PHASe | 753 |
| WGENerator:BURSt[:STATe] | 753 |

WGENerator:BURSt:ITIME <IdleTime>

Sets the idle time between two burst cycles.

Parameters:

<IdleTime> Range: 28n to 17
*RST: 100u
Default unit: s

WGENerator:BURSt:NCYCLe <NumberOfCycles>

Sets the number of times the generator outputs one cycle of the waveform per burst.

Parameters:

<NumberOfCycles> Range: 1 to 1023
 Increment: 1
 *RST: 1

WGENerator:BURSt:PHASe <PhaseOffset>

Sets the start phase of the burst.

Parameters:

<PhaseOffset> Range: 0 to 360
 Increment: 0.1
 *RST: 0
 Default unit: Degree

WGENerator:BURSt[:STATe] <Enable>

Enables or disables the burst. for the generator.

Parameters:

<Enable> ON | OFF
 *RST: OFF

16.14.1.4 Modulation Settings

| | |
|---|-----|
| WGENerator:MODulation[:ENABLE]..... | 753 |
| WGENerator:MODulation:FUNCTion..... | 753 |
| WGENerator:MODulation:TYPE..... | 754 |
| WGENerator:MODulation:AM:FREQuency..... | 754 |
| WGENerator:MODulation:AM:DEPTH..... | 754 |
| WGENerator:MODulation:FM:FREQuency..... | 754 |
| WGENerator:MODulation:FM:DEVIation..... | 755 |
| WGENerator:MODulation:ASK:FREQuency..... | 755 |
| WGENerator:MODulation:ASK:DEPTH..... | 755 |
| WGENerator:MODulation:FSK:HFREQuency..... | 755 |
| WGENerator:MODulation:FSK:RATE..... | 755 |
| WGENerator:MODulation:RAMP:POLarity..... | 755 |

WGENerator:MODulation[:ENABLE] <Enable>

Activates or deactivates modulation of the function generator output. To define the modulation function, see [WGENerator:MODulation:FUNCTion](#).

Parameters:

<Enable> ON | OFF

WGENerator:MODulation:FUNCTion <ModulationFunction>

Selects a function for the modulation.

Parameters:

<ModulationFunction>SINusiod | SQUare | TRIangle | RAMP

WGENerator:MODulation:TYPE <ModulationType>

Sets the modulation type, which defines how the carrier signal is modified.

Parameters:

<ModulationType> AM | FM | ASK | FSK

AM

Amplitude modulation. The amplitude of the carrier signal is varied according to the modulation signal.

FM

Frequency modulation. The frequency of the carrier signal is varied according to the modulation signal.

ASK

Amplitude shift keying (ASK) modulation. The amplitude switches between 100% and the `WGENerator:MODulation:ASK:DEPTH` amplitude with a defined modulating `WGENerator:MODulation:ASK:FREQUENCY`.

FSK

Frequency shift keying (FSK) modulation. The signal frequency switches between the carrier frequency and the `WGENerator:MODulation:FSK:HFREQUENCY` at a `WGENerator:MODulation:FSK:RATE`.

WGENerator:MODulation:AM:FREQUENCY <Frequency>

Sets the frequency of the modulating waveform for AM modulation.

Parameters:

<Frequency>

WGENerator:MODulation:AM:DEPTH <ModulationDepth>

Sets the modulation depth, the percentage of the amplitude range that is used for AM modulation.

Parameters:

<ModulationDepth>

WGENerator:MODulation:FM:FREQUENCY <Frequency>

Sets the frequency of the modulating waveform for FM modulation.

Parameters:

<Frequency>

WGENerator:MODulation:FM:DEVIation <Deviation>

Sets the frequency deviation, the maximum difference between the FM modulated signal and the carrier signal.

Parameters:
<Deviation>

WGENerator:MODulation:ASK:FREQUency <Frequency>

Sets the frequency of the modulating waveform for ASK modulation.

Parameters:
<Frequency>

WGENerator:MODulation:ASK:DEPTTh <ModulationDepth>

Sets the modulation depth, the percentage of the amplitude range that is used for ASK modulation.

Parameters:
<ModulationDepth>

WGENerator:MODulation:FSK:HFREquency <HoppingFrequency>

Sets the second frequency of the FSK-modulated signal.

Parameters:
<HoppingFrequency> The range depends on the signal type:
Sinus: 100mHz - 25MHz
Sinc/Triangle/Ramp/Exponential: 100mHz - 1MHz
Rectangle/Pulse/Arbitrary: 100mHz - 10MHz

WGENerator:MODulation:FSK:RATE <Rate>

Sets the rate at which signal switches between the carrier frequency and the hopping frequency.

Parameters:
<Rate> Range: 0.1 to 1E6
 Default unit: Hz

WGENerator:MODulation:RAMP:POLarity <Polarity>

Sets the polarity for the ramp function for a modulation waveform.

Parameters:
<Polarity> POSitive | NEGative

16.14.1.5 Sweep Settings

| | |
|--------------------------------|-----|
| WGENerator:SWEep:FEND..... | 756 |
| WGENerator:SWEep:FStart..... | 756 |
| WGENerator:SWEep:TIME..... | 756 |
| WGENerator:SWEep:TYPE..... | 756 |
| WGENerator:SWEep[:ENABLE]..... | 756 |

WGENerator:SWEep:FEND <StopFrequency>

Sets the stop frequency of the sweep signal.

Parameters:

<StopFrequency>

WGENerator:SWEep:FStart <StartFrequency>

Sets the start frequency of the sweep signal.

Parameters:

<StartFrequency>

WGENerator:SWEep:TIME <SweepTime>

Sets the duration of the sweep.

Parameters:

<SweepTime>

WGENerator:SWEep:TYPE <SweepType>

Sets the type of the sweep, a linear, logarithmic or triangle-shaped change of the frequency.

Parameters:

<SweepType> LINear | LOGarithmic | TRIangle

WGENerator:SWEep[:ENABLE] <SweepEnable>

Enables or disables sweeping.

Parameters:

<SweepEnable> ON | OFF

16.14.2 Pattern Generator

| | |
|--------------------------|-----|
| • General Settings..... | 757 |
| • Square Wave..... | 758 |
| • Counter Pattern..... | 759 |
| • Arbitrary Pattern..... | 760 |
| • Manual Pattern..... | 762 |
| • PWM Signals..... | 763 |

16.14.2.1 General Settings

PGENERator:FUNCtion <PatternFunction>

Selects the pattern generator function.

Parameters:

<PatternFunction> SQUarewave | COUNter | ARBitary | SPI | I2C | UART | CAN | LIN | MANual | I2S | TDM | TPWM | PWM | LEDPwm

SQUarewave

Square wave function (e.g. for manual probe compensation).

COUNter

Definition of a 4-bit wide counter pattern.

ARBitary

Definition of a 4-bit wide and 2048 samples deep pattern.

SPI

SPI BUS signals for measurements without measurement object. Data rate 100 kBit/s, 250 kBit/s or 1 MBit/s.

I2C

I²C BUS signals for measurements without measurement object. Data rate 100 kBit/s, 400 kBit/s, 1 MBit/s or 3.4 MBit/s.

UART

UART BUS signals for measurements without measurement object. Data rate 9600 Bit/s, 115.2 kBit/s and 1 MBit/s.

CAN

CAN BUS signals for measurements without measurement object up to 50 MBit/s.

LIN

LIN BUS signals for measurements without measurement object up to 50 MBit/s.

MANual

Manual pattern mode.

I2S

Audio-I2S BUS signal.

TDM

Audio-TDM BUS signal.

TPWM

Test signals with pulse width modulation.

PWM

Pulse width modulated signal.

LEDPwm

Pulse width modulated signal for LED color control.

*RST: SQUAREwave

PGENERator:PATtern:STATe <State>

Activates or deactivates the pattern.

Parameters:

<State> ON | OFF

*RST: OFF

PGENERator:PATtern:TRIGger:EXTern:SLOPe

Defines the slope of the external arbitrary pattern trigger.

Parameters:

<ExternSlope> POSitive | NEGative | EITHer

POSitive

Rising edge (rise).

NEGative

Falling edge (fall).

EITHer

Rising as well as the falling edge (both).

*RST: POSitive

16.14.2.2 Square Wave**PGENERator:PATtern:SQUarewave:POLarity <Polarity>**

Defines the polarity of the pattern generator square wave function.

Parameters:

<Polarity> NORMAl | INVerted

*RST: NORM

PGENERator:PATtern:SQUarewave:DCYCLE <DutyCycle>

Sets the duty cycle of the square wave function.

Parameters:

<DutyCycle> Numeric value

Range: 1.00E+00 to 9.900E+01

*RST: 5.000E+01

Default unit: %

Example:

PGEN:PATT:SQU:DCYC 20

Sets the duty cycle of the square wave function to 20%.

PGENERator:PATtern:PERiod <PatternPeriod>

Defines the period of the pattern generator function.

Parameters:

<PatternPeriod> Numeric value (Period = Pattern length * Bit time)
 Range: MIN 1 Sample * 20ns = 20ns to MAX 2048 Samples * 42s = 10416s (approx. 2.89h)
 *RST: 2.000E-06
 Default unit: s

PGENERator:PATtern:FREQuency <PatternFrequency>

Defines the frequency (period) value of the pattern generator function.

Parameters:

<PatternFrequency> Numeric value
 Default unit: Hz

16.14.2.3 Counter Pattern**PGENERator:PATtern:COUNter:FREQuency** <Period>

Defines the frequency value of the pattern generator counter function. The user frequency always refers to the switching of the pattern condition. This results in square waveforms for individual pins.

| Pin | Frequency |
|-----|-----------|
| S0 | f/2 |
| S1 | f/4 |
| S2 | f/8 |
| S3 | f/16 |

Parameters:

<Period> Numeric value
 Range: 2.380952425301E-02 to 2.500000000000E+07
 *RST: 1.000000000000E+05
 Default unit: Hz

PGENERator:PATtern:COUNter:DIRection <CountDirection>

Sets the pattern generator counter direction.

Parameters:

<CountDirection> UPWard | DOWNward
 *RST: UPW

16.14.2.4 Arbitrary Pattern

PGENERator:PATTERN:TRIGGER:MODE <TriggerMode>

Defines the arbitrary trigger mode of the pattern generator function.

Parameters:

<TriggerMode> CONTInuous | SINGle

CONTInuous

The CONT function (continuous trigger) issues the pattern continuously.

SINGle

If the SING setting is activated, the pattern is issued manually.

*RST: CONT

PGENERator:PATTERN:ARBITRARY:DATA[:SET] <ArbitraryData>

Defines the arbitrary pattern.

Parameters:

<ArbitraryData> List of Values

Example: PGEN:PATT:ARB:DATA 0,1,1,1,2,0,3,1,4,0

PGENERator:PATTERN:ARBITRARY:DATA:LENGTH <PatternLength>

Defines the arbitrary pattern length.

Parameters:

<PatternLength> Numeric value

Range: 1 to 2048

*RST: 1

PGENERator:PATTERN:ARBITRARY:DATA:APPend <AppendData>

Defines the arbitrary pattern.

Setting parameters:

<AppendData> List of Values

Example: PGEN:PATT:ARB:DATA:APP 4

From `index = n`, the oscilloscope appends a 4 in HEX to the pattern.

Usage: Setting only

PGENERator:PATTERN:ARBITRARY:DATA:APPend:BOR <AppendData>

From `index = n`, data will be integrated in existing pattern via OR combination.

Setting parameters:

<AppendData> List of Values

Usage: Setting only

PGENERator:PATTern:ARBITrary:DATA:APPend:BAND <AppendData>

From `index = n`, data will be integrated in existing pattern via AND combination.

Setting parameters:

<AppendData> List of Values

Usage: Setting only

PGENERator:PATTern:ARBITrary:DATA:APPend:INDex <AppendIndex>

Defines the index of the arbitrary pattern.

Parameters:

<AppendIndex> Numeric value

Example:

PGEN:PATT:ARB:DATA:APP:IND 5

PGEN:PATT:ARB:DATA:APP 4

From `index = n`, a pattern length of 6 will be defined with last high bit 4.

PGENERator:PATTern:TRIGger:SINGLE

Manual output of a pattern (single trigger).

Usage: Event

PGENERator:PATTern:STIME <SampleTime>

Sets the time at which each sample is applied for the pattern generator function.

Parameters:

<SampleTime> Numeric value

Range: 2.000E-08 to 4.200E+01

*RST: 2.000E-08

Default unit: s

PGENERator:PATTern:ITIME <IdleTime>

Defines the idle time of the pattern generator function. The idle time can be only defined with activated BURST function.

Parameters:

<IdleTime> Numeric value
 Range: 2.000E-08 to 4.200000000000E+01
 *RST: 2.5000000000E-01
 Default unit: s

PGENerator:PATtern:BURSt:STATe <BurstState>

Turns the BURST function on or off.

Parameters:

<BurstState> ON | OFF
 *RST: OFF

PGENerator:PATtern:BURSt:NCYClE <PatternCycles>

Defines the BURST pattern cycles. The cycles can be only defined with activated BURST function.

Parameters:

<PatternCycles> Numeric value
 Range: 1 to 4096
 *RST: 1

16.14.2.5 Manual Pattern**PGENerator:MANual:STATe<s>** <State>

Selects the pins S0 to S3 manually and sets their states to high (H) or low (L).

Suffix:

<s> 0..3
 Pins S0 to S3

Parameters:

<State> ON | OFF
ON
 Pin state is set to high (H).
OFF
 Pin state is set to low (L).
 *RST: OFF

Example:

PGEN:MAN:STAT2 ON
 Sets the state of pin S2 to high (H).

16.14.2.6 PWM Signals

PGENERator:PATtern:PWM:DCYCLE <DutyCycle>

Sets the duty cycle of the PWM signal at P0, and thus the motor speed.

Parameters:

| | | |
|-------------|---------------|---------|
| <DutyCycle> | Range: | 1 to 99 |
| | Increment: | 1 |
| | *RST: | 50 |
| | Default unit: | % |

PGENERator:PATtern:PWM:DIRection <Direction>

Sets the direction of motor rotation.

Parameters:

| | |
|-------------|---------------------|
| <Direction> | POSitive NEGative |
|-------------|---------------------|

PGENERator:PATtern:PWM:ENABLE <Enable>

Switches the motor on or off if the motor driver uses a dedicated enable signal.

Parameters:

| | |
|----------|----------|
| <Enable> | ON OFF |
|----------|----------|

PGENERator:PATtern:LED:BLUE <DutyCycle>

PGENERator:PATtern:LED:GREEN <DutyCycle>

PGENERator:PATtern:LED:RED <DutyCycle>

Set the duty cycle of the red, green, and blue colors, which corresponds to the color intensity.

Parameters:

| | | |
|-------------|---------------|---------|
| <DutyCycle> | Range: | 1 to 99 |
| | Increment: | 1 |
| | *RST: | 50 |
| | Default unit: | % |

PGENERator:PATtern:LED:INTens <DutyCycle>

Sets the duty cycle of the signal at P3, which corresponds to the intensity of the light. You can use this signal if the controller supports separate intensity control.

Parameters:

| | | |
|-------------|---------------|---------|
| <DutyCycle> | Range: | 1 to 99 |
| | Increment: | 1 |
| | *RST: | 50 |
| | Default unit: | % |

16.15 Status Reporting

16.15.1 STATus:OPERation Register

The commands of the `STATus:OPERation` subsystem control the status reporting structures of the `STATus:OPERation` register:

See also:

- [Chapter B.1, "Structure of a SCPI Status Register"](#), on page 784
- [Chapter B.3.3, "STATus:OPERation Register"](#), on page 789

The following commands are available:

| | |
|---|-----|
| <code>STATus:OPERation:CONDition?</code> | 764 |
| <code>STATus:OPERation:ENABle</code> | 764 |
| <code>STATus:OPERation:NTRansition</code> | 765 |
| <code>STATus:OPERation:PTRansition</code> | 765 |
| <code>STATus:OPERation[:EVENT]?</code> | 765 |

STATus:OPERation:CONDition?

Returns the of the `CONDition` part of the operational status register.

Return values:

<Condition> Condition bits in decimal representation. `ALIGNment` (bit 0) , `SELFTest` (bit 1) , `AUToset` (bit 2), `WTRigger` (bit 3).
 Range: 1 to 65535
 Increment: 1

Usage: Query only

STATus:OPERation:ENABle <Enable>

Controls the `ENABle` part of the `STATus:OPERation` register. The `ENABle` defines which events in the `EVENT` part of the status register are forwarded to the `OPERation` summary bit (bit 7) of the status byte. The status byte can be used to create a service request.

Parameters:

<Enable> Range: 1 to 65535
 Increment: 1

Example:

`STATus:OPERation:ENABle 5`
 The `ALIGNment` event (bit 0) and `AUToset` event (bit 2) are forwarded to the `OPERation` summary bit of the status byte.

STATus:OPERation:NTRansition <NegativeTransition>**Parameters:**

<NegativeTransition> Range: 1 to 65535
Increment: 1

STATus:OPERation:PTRansition <PositiveTransition>**Parameters:**

<PositiveTransition> Range: 1 to 65535
Increment: 1

STATus:OPERation[:EVENT]?**Return values:**

<Event> Range: 1 to 65535
Increment: 1

Usage: Query only

16.15.2 STATus:QUEStionable Registers

The commands of the `STATus:QUEStionable` subsystem control the status reporting structures of the `STATus:QUEStionable` registers:

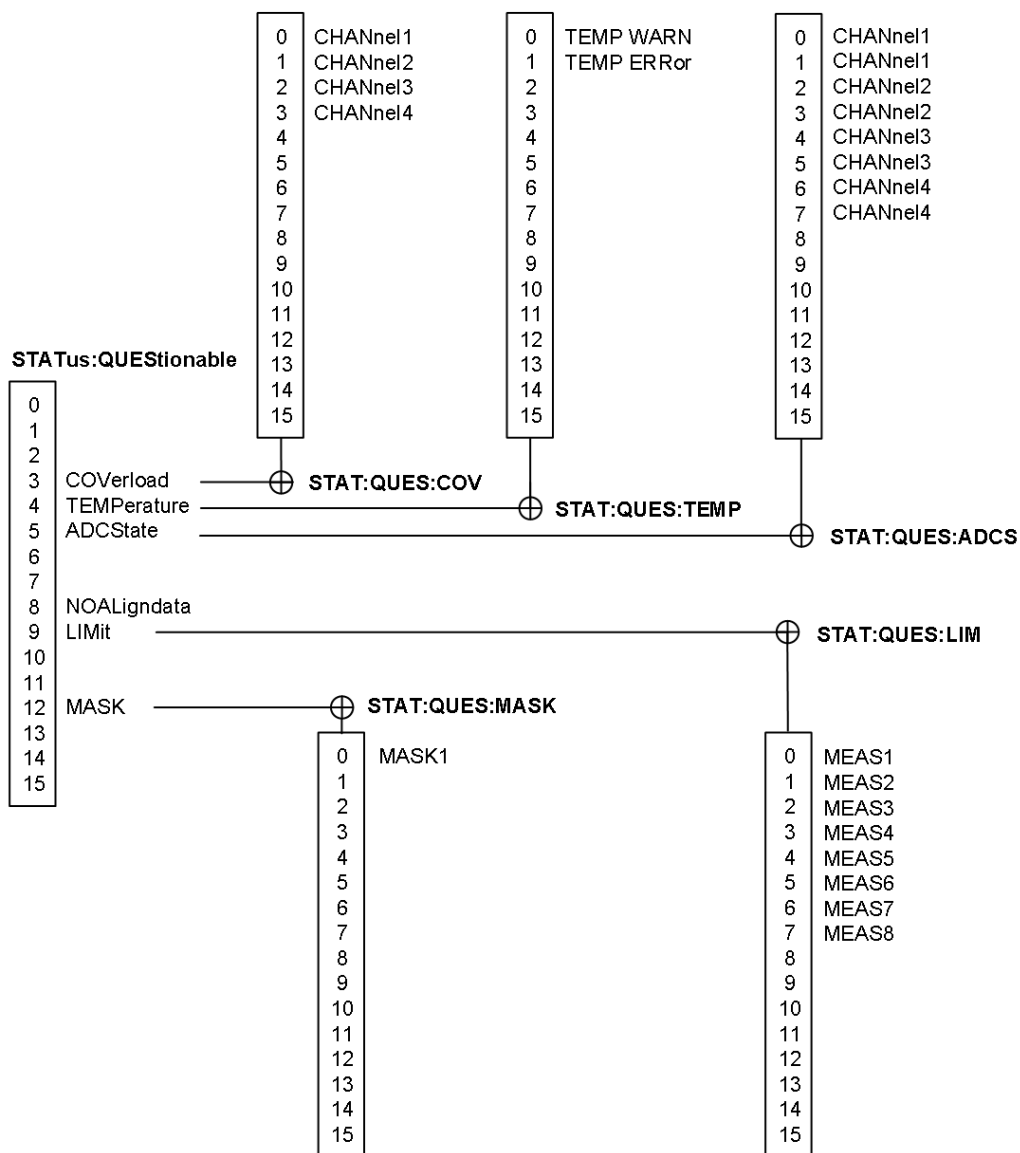

Figure 16-1: Structure of the `STATus:QUEStionable` register

See also:

- Chapter B.1, "Structure of a SCPI Status Register", on page 784
- Chapter B.3.4, "`STATus:QUEStionable` Register", on page 789

The following commands are available:

| | |
|---|-----|
| <code>STATus:PRESet</code> | 767 |
| <code>STATus:QUEStionable:CONDition?</code> | 767 |
| <code>STATus:QUEStionable:COVerload:CONDition?</code> | 767 |
| <code>STATus:QUEStionable:ADCState:CONDition?</code> | 767 |
| <code>STATus:QUEStionable:LIMit:CONDition?</code> | 767 |
| <code>STATus:QUEStionable:MASK:CONDition?</code> | 767 |
| <code>STATus:QUEStionable:ENABLE</code> | 767 |
| <code>STATus:QUEStionable:COVerload:ENABLE</code> | 767 |

| | |
|--|-----|
| STATus:QUESTionable:ADCState:ENABle..... | 767 |
| STATus:QUESTionable:LIMit:ENABle..... | 768 |
| STATus:QUESTionable:MASK:ENABle..... | 768 |
| STATus:QUESTionable[:EVENT]? | 768 |
| STATus:QUESTionable:COVerload[:EVENT]? | 768 |
| STATus:QUESTionable:ADCState[:EVENT]? | 768 |
| STATus:QUESTionable:LIMit[:EVENT]? | 768 |
| STATus:QUESTionable:MASK[:EVENT]? | 768 |
| STATus:QUESTionable:NTRansition..... | 768 |
| STATus:QUESTionable:COVerload:NTRansition..... | 768 |
| STATus:QUESTionable:ADCState:NTRansition..... | 768 |
| STATus:QUESTionable:LIMit:NTRansition..... | 768 |
| STATus:QUESTionable:MASK:NTRansition..... | 768 |
| STATus:QUESTionable:PTRansition..... | 769 |
| STATus:QUESTionable:COVerload:PTRansition..... | 769 |
| STATus:QUESTionable:ADCState:PTRansition..... | 769 |
| STATus:QUESTionable:LIMit:PTRansition..... | 769 |
| STATus:QUESTionable:MASK:PTRansition..... | 769 |

STATus:PRESet

Resets all STATUS:QUESTIONABLE registers.

Usage: Event

STATus:QUESTionable:CONDition?**STATus:QUESTionable:COVerload:CONDition?****STATus:QUESTionable:ADCState:CONDition?****STATus:QUESTionable:LIMit:CONDition?****STATus:QUESTionable:MASK:CONDition?**

Returns the contents of the CONDition part of the status register to check for questionable instrument or measurement states. Reading the CONDition registers does not delete the contents.

Return values:

<Condition> Condition bits in decimal representation

Range: 0 to 65535

Increment: 1

Usage: Query only

STATus:QUESTionable:ENABle <Enable>

STATus:QUESTionable:COVerload:ENABle <Enable>

STATus:QUESTionable:ADCState:ENABle <Enable>

STATus:QUESTIONable:LIMit:ENABle <Enable>

STATus:QUESTIONable:MASK:ENABle <Enable>

Sets the ENABle part that allows true conditions in the EVENT part to be reported in the summary bit. If a bit is set to 1 in the enable part and its associated event bit transitions to true, a positive transition occurs in the summary bit and is reported to the next higher level.

Parameters:

<Enable> Bit mask in decimal representation
 Range: 0 to 65535
 Increment: 1

Example:

STATus:QUESTIONable:MASK:ENABle 24
 Set bits no. 3 and 4 of the STATus:QUESTIONable:MASK:ENABle register part: $24 = 8 + 16 = 2^3 + 2^4$

STATus:QUESTIONable[:EVENT]?

STATus:QUESTIONable:COVERload[:EVENT]?

STATus:QUESTIONable:ADCState[:EVENT]?

STATus:QUESTIONable:LIMit[:EVENT]?

STATus:QUESTIONable:MASK[:EVENT]?

Returns the contents of the EVENT part of the status register to check whether an event has occurred since the last reading. Reading an EVENT register deletes its contents.

Return values:

<Event> Event bits in decimal representation
 Range: 0 to 65535
 Increment: 1

Usage: Query only

STATus:QUESTIONable:NTRansition <NegativeTransition>

STATus:QUESTIONable:COVERload:NTRansition <NegativeTransition>

STATus:QUESTIONable:ADCState:NTRansition <NegativeTransition>

STATus:QUESTIONable:LIMit:NTRansition <NegativeTransition>

STATus:QUESTIONable:MASK:NTRansition <NegativeTransition>

Sets the negative transition filter. If a bit is set, a 1 to 0 transition in the corresponding bit of the condition register causes a 1 to be written in the corresponding bit of the event register.

Parameters:

<NegativeTransition> Bit mask in decimal representation
 Range: 0 to 65535
 Increment: 1

Example:

STATus:QUESTIONable:MASK:NTRansition 24
 Set bits no. 3 and 4 of the STATus:QUESTIONable:MASK:NTRansition register part: $24 = 8 + 16 = 2^3 + 2^4$

STATus:QUESTionable:PTRansition <PositiveTransition>
STATus:QUESTionable:COVerload:PTRansition <PositiveTransition>
STATus:QUESTionable:ADCState:PTRansition <PositiveTransition>
STATus:QUESTionable:LIMit:PTRansition <PositiveTransition>
STATus:QUESTionable:MASK:PTRansition <PositiveTransition>

Sets the positive transition filter. If a bit is set, a 0 to 1 transition in the corresponding bit of the condition register causes a 1 to be written in the corresponding bit of the event register.

Parameters:

<PositiveTransition> Bit mask in decimal representation

Range: 0 to 65535

Increment: 1

Example:

`STATus:QUESTionable:MASK:PTRansition 24`

Set bits no. 3 and 4 of the `STATus:QUESTionable:MASK:PTRansition` register part: $24 = 8 + 16 = 2^3 + 2^4$

17 Maintenance

The instrument does not need a periodic maintenance. Only the cleaning of the instrument is essential.

To protect the front panel and to transport the instrument to another workplace safely and easily, several accessories are provided. The type designations and order numbers are listed in the data sheet.

In case of instrument damage, contact the nearest Rohde & Schwarz service center. A list of all service centers is available on www.services.rohde-schwarz.com.

The addresses of Rohde & Schwarz support centers can be found at www.customer-support.rohde-schwarz.com.

17.1 Cleaning

1. Clean the outside of the instrument using a soft, dry, lint-free dust cloth.
Note: Do not use any liquids for cleaning. Cleaning agents, solvents (thinners, acetone), acids and bases can damage the front panel labeling, plastic parts and display.
2. Check and clean the fans regularly to ensure that they always operate properly.
3. Clean the touchscreen as follows:
 - a) Apply a small amount of standard screen cleaner to a soft cloth.
 - b) Wipe the screen gently with the moist, but not wet, cloth.
 - c) If necessary, remove any excess moisture with a dry, soft cloth.

17.2 Storing and Packing

The storage temperature range of the instrument is given in the data sheet. If the instrument is to be stored for a longer period of time, it must be protected against dust.

Repack the instrument as it was originally packed when transporting or shipping. The two protective foam plastic parts prevent the control elements and connectors from being damaged. The antistatic packing foil avoids any undesired electrostatic charging to occur.

If you do not use the original packaging, use a sturdy cardboard box of suitable size and provide for sufficient padding to prevent the instrument from slipping inside the package. Wrap antistatic packing foil around the instrument to protect it from electrostatic charging.

17.3 Replacing the Fuse

The instrument is protected by a fuse. You can find it on the rear panel between the main power switch and AC power supply.

Type of fuse: Size 5x20 mm, 250V~, T3.15H (slow-blow), IEC60127-2/5

WARNING

Risk of electric shock

The fuse is part of the main power supply. Therefore, handling the fuse while power is on can lead to electric shock. Before opening the fuse holder, make sure that the instrument is switched off and disconnected from all power supplies.

Always use fuses supplied by Rohde & Schwarz as spare parts, or fuses of the same type and rating.

1. Pull the fuse holder out of its slot on the rear panel.
2. Exchange the fuse.
3. Insert the fuse holder carefully back in its slot until it latches.

17.4 Data Security

If you have to send the instrument to the service, or if the instrument is used in a secured environment, consider the document "Instrument Security Procedures" that is available on the R&S RTM3000 internet web page.

You can delete all current instrument configuration data and user data with "Setup" menu > "Secure Erase".

Annex

A Remote Control - Basics

A.1 SCPI Command Structure

SCPI commands consist of a header and, in most cases, one or more parameters. The header and the parameters are separated by a "white space" (ASCII code 0 to 9, 11 to 32 decimal, e.g. blank). The headers may consist of several mnemonics (keywords). Queries are formed by appending a question mark directly to the header.

The commands can be either device-specific or device-independent (common commands). Common and device-specific commands differ in their syntax.

A.1.1 Syntax for Common Commands

Common (= device-independent) commands consist of a header preceded by an asterisk (*), and possibly one or more parameters.

Table A-1: Examples of common commands

| | | |
|-------|----------------------|---|
| *RST | RESET | Resets the instrument. |
| *ESE | EVENT STATUS ENABLE | Sets the bits of the event status enable registers. |
| *ESR? | EVENT STATUS QUERY | Queries the contents of the event status register. |
| *IDN? | IDENTIFICATION QUERY | Queries the instrument identification string. |

A.1.2 Syntax for Device-Specific Commands



Not all commands used in the following examples are necessarily implemented in the instrument. For demonstration purposes only, assume the existence of the following commands for this section:

- DISPLAY[:WINDow<1...4>]:MAXimize <Boolean>
- FORMat:READings:DATA <type>[,<length>]
- HCOpy:DEvice:COLor <Boolean>
- HCOpy:DEvice:CMAP:COLor:RGB <red>,<green>,<blue>
- HCOpy[:IMMediate]
- HCOpy:ITEM:ALL
- HCOpy:ITEM:LABel <string>
- HCOpy:PAGE:DIMensions:QUADrant [<N>]
- HCOpy:PAGE:ORientation LANDscape | PORTrait
- HCOpy:PAGE:SCALE <numeric value>
- MMEMemory:COpy <file_source>,<file_destination>
- SENSE:BANDwidth|BWIDth[:RESolution] <numeric_value>
- SENSE:FREQuency:STOP <numeric value>
- SENSE:LIST:FREQuency <numeric_value>{,<numeric_value>}

| | |
|---|-----|
| • Long and short form | 773 |
| • Numeric Suffixes | 773 |
| • Optional Mnemonics | 774 |

A.1.2.1 Long and short form

The mnemonics feature a long form and a short form. The short form is marked by upper case letters, the long form corresponds to the complete word. Either the short form or the long form can be entered; other abbreviations are not permitted.

Example:

HCOpy:DEvice:COLor ON is equivalent to HCOP:DEV:COL ON.



Case-insensitivity

Upper case and lower case notation only serves to distinguish the two forms in the manual, the instrument itself is case-insensitive.

A.1.2.2 Numeric Suffixes

If a command can be applied to multiple instances of an object, e.g. specific channels or sources, the required instances can be specified by a suffix added to the command. Numeric suffixes are indicated by angular brackets (<1...4>, <n>, <i>) and are replaced

by a single value in the command. Entries without a suffix are interpreted as having the suffix 1.

Example:

Definition: `HCOPY:PAGE:DIMensions:QUADrant [<N>]`

Command: `HCOP:PAGE:DIM:QUAD2`

This command refers to the quadrant 2.



Different numbering in remote control

For remote control, the suffix may differ from the number of the corresponding selection used in manual operation. SCPI prescribes that suffix counting starts with 1. Suffix 1 is the default state and used when no specific suffix is specified.

Some standards define a fixed numbering, starting with 0. If the numbering differs in manual operation and remote control, it is indicated for the corresponding command.

A.1.2.3 Optional Mnemonics

Some command systems permit certain mnemonics to be inserted into the header or omitted. These mnemonics are marked by square brackets in the description. The instrument must recognize the long command to comply with the SCPI standard. Some commands are considerably shortened by these optional mnemonics.

Example:

Definition: `HCOPY[:IMMEDIATE]`

Command: `HCOP:IMM` is equivalent to `HCOP`



Optional mnemonics with numeric suffixes

Do not omit an optional mnemonic if it includes a numeric suffix that is relevant for the effect of the command.

Example:

Definition: `DISPlay[:WINDow<1...4>]:MAXimize <Boolean>`

Command: `DISP:MAX ON` refers to window 1.

In order to refer to a window other than 1, you must include the optional `WINDow` parameter with the suffix for the required window.

`DISP:WIND2:MAX ON` refers to window 2.

A.1.3 SCPI Parameters

Many commands are supplemented by a parameter or a list of parameters. The parameters must be separated from the header by a "white space" (ASCII code 0 to 9, 11 to 32 decimal, e.g. blank).

The parameters required for each command and the allowed range of values are specified in the command description.

Allowed parameters are:

| | |
|--|-----|
| • Numeric Values | 775 |
| • Special Numeric Values | 775 |
| • Boolean Parameters | 776 |
| • Text Parameters | 776 |
| • Character Strings | 777 |
| • Block Data | 777 |

A.1.3.1 Numeric Values

Numeric values can be entered in any form, i.e. with sign, decimal point and exponent. Values exceeding the resolution of the instrument are rounded up or down. The mantissa may comprise up to 255 characters, the exponent must lie inside the value range -32000 to 32000. The exponent is introduced by an "E" or "e". Entry of the exponent alone is not allowed.

Example:

```
SENS:FREQ:STOP 1500000 = SENS:FREQ:STOP 1.5E6
```

Units

For physical quantities, the unit can be entered. If the unit is missing, the basic unit is used. Allowed unit prefixes are:

- G (giga)
- MA (mega), MOHM, MHZ
- K (kilo)
- M (milli)
- U (micro)
- N (nano)

Example:

```
SENSe:FREQ:STOP 1.5GHz = SENSe:FREQ:STOP 1.5E9
```

Some settings allow relative values to be stated in percent. According to SCPI, this unit is represented by the PCT string.

Example:

```
HCOP:PAGE:SCAL 90PCT
```

A.1.3.2 Special Numeric Values

The following mnemonics are special numeric values. In the response to a query, the numeric value is provided.

- **MIN and MAX:** denote the minimum and maximum value.
- **DEF:** denotes a preset value which has been stored in the EPROM. This value conforms to the default setting, as it is called by the *RST command.
- **NAN:** Not A Number (NAN) represents the value 9.91E37. NAN is only sent as a instrument response. This value is not defined. Possible causes are the division of zero by zero, the subtraction of infinite from infinite and the representation of missing values.

Example:

Setting command: `SENSe:LIST:FREQ MAXimum`

Query: `SENS:LIST:FREQ?`

Response: `3.5E9`

**Queries for special numeric values**

The numeric values associated to `MAXimum`/`MINimum`/`DEFault` can be queried by adding the corresponding mnemonic after the quotation mark.

Example: `SENSe:LIST:FREQ? MAXimum`

Returns the maximum numeric value as a result.

A.1.3.3 Boolean Parameters

Boolean parameters represent two states. The "ON" state (logically true) is represented by "ON" or a numeric value 1. The "OFF" state (logically untrue) is represented by "OFF" or the numeric value 0. The numeric values are provided as the response for a query.

Example:

Setting command: `HCOPY:DEV:COL ON`

Query: `HCOPY:DEV:COL?`

Response: `1`

A.1.3.4 Text Parameters

Text parameters observe the syntactic rules for mnemonics, i.e. they can be entered using a short or long form. Like any parameter, they have to be separated from the header by a white space. In the response to a query, the short form of the text is provided.

Example:

Setting command: `HCOPY:PAGE:ORIENTATION LANDscape`

Query: `HCOP:PAGE:ORI?`

Response: `LAND`

A.1.3.5 Character Strings

Strings must always be entered in quotation marks (' or ").

Example:

```
HCOP:ITEM:LABel "Test1"
```

```
HCOP:ITEM:LABel 'Test1'
```

A.1.3.6 Block Data

Block data is a format which is suitable for the transmission of large amounts of data. For example, a command using a block data parameter has the following structure:

```
FORMat:READings:DATA #45168xxxxxxxx
```

The ASCII character # introduces the data block. The next number indicates how many of the following digits describe the length of the data block. In the example the 4 following digits indicate the length to be 5168 bytes. The data bytes follow. During the transmission of these data bytes all end or other control signs are ignored until all bytes are transmitted.

#0 specifies a data block of indefinite length. The use of the indefinite format requires a `NL^END` message to terminate the data block. This format is useful when the length of the transmission is not known or if speed or other considerations prevent segmentation of the data into blocks of definite length.

A.1.4 Overview of Syntax Elements

The following tables provide an overview of the syntax elements and special characters.

Table A-2: Syntax elements

| | |
|-----|---|
| : | The colon separates the mnemonics of a command. |
| ; | The semicolon separates two commands of a command line. It does not alter the path. |
| , | The comma separates several parameters of a command. |
| ? | The question mark forms a query. |
| * | The asterisk marks a common command. |
| ' ' | Quotation marks introduce a string and terminate it (both single and double quotation marks are possible). |
| # | The hash symbol introduces binary, octal, hexadecimal and block data. <ul style="list-style-type: none"> • Binary: #B10110 • Octal: #O7612 • Hexa: #HF3A7 • Block: #21312 |
| | A "white space" (ASCII-Code 0 to 9, 11 to 32 decimal, e.g. blank) separates the header from the parameters. |

Table A-3: Special characters

| | |
|-----|--|
| | <p>Parameters</p> <p>A vertical stroke in parameter definitions indicates alternative possibilities in the sense of "or". The effect of the command differs, depending on which parameter is used.</p> <p>Example:</p> <p>Definition:HCOPY:PAGE:ORIENTATION LANDscape PORTRait</p> <p>Command HCOP:PAGE:ORI LAND specifies landscape orientation</p> <p>Command HCOP:PAGE:ORI PORT specifies portrait orientation</p> <p>Mnemonics</p> <p>A selection of mnemonics with an identical effect exists for several commands. These mnemonics are indicated in the same line; they are separated by a vertical stroke. Only one of these mnemonics needs to be included in the header of the command. The effect of the command is independent of which of the mnemonics is used.</p> <p>Example:</p> <p>DefinitionSENSE:BANDwidth BWIDTH[:RESolution] <numeric_value></p> <p>The two following commands with identical meaning can be created:</p> <p>SENS:BAND:RES 1</p> <p>SENS:BWID:RES 1</p> |
| [] | <p>Mnemonics in square brackets are optional and may be inserted into the header or omitted.</p> <p>Example: HCOpy[:IMMEDIATE]</p> <p>HCOP: IMM is equivalent to HCOP</p> |
| { } | <p>Parameters in curly brackets are optional and can be inserted once or several times, or omitted.</p> <p>Example: SENSE:LIST:FREQuency <numeric_value>{,<numeric_value>}</p> <p>The following are valid commands:</p> <p>SENS:LIST:FREQ 10</p> <p>SENS:LIST:FREQ 10,20</p> <p>SENS:LIST:FREQ 10,20,30,40</p> |

A.1.5 Structure of a Command Line

A command line may consist of one or several commands. It is terminated by one of the following:

- <New Line>
- <New Line> with EOI
- EOI together with the last data byte

Several commands in a command line must be separated by a semicolon ";".

Example:

```
MMEM:COPY "Test1","MeasurementXY";:HCOP:ITEM ALL
```

This command line contains two commands. The first command belongs to the MMEM system, the second command belongs to the HCOP system. If the next command belongs to a different command system, the semicolon is followed by a colon.

Example:

```
HCOP:ITEM ALL;:HCOP:IMM
```

This command line contains two commands. Both commands are part of the `HCOP` command system, i.e. they have one level in common.

If the successive commands belong to the same system, having one or several levels in common, the command line can be abbreviated. When abbreviating the command line, the second command begins with the level below `HCOP`. The colon after the semi-colon is omitted. The abbreviated form of the command line reads as follows:

```
HCOP:ITEM ALL;IMM
```

Example:

```
HCOP:ITEM ALL
```

```
HCOP:IMM
```

A new command line always begins with the complete path.

A.1.6 Responses to Queries

A query is defined for each setting command unless explicitly specified otherwise. It is formed by adding a question mark to the associated setting command. According to SCPI, the responses to queries are partly subject to stricter rules than in standard IEEE 488.2.

- The requested parameter is transmitted without a header.
Example: `HCOP:PAGE:ORI?`, **Response:** `LAND`
- Maximum values, minimum values and all other quantities that are requested via a special text parameter are returned as numeric values.
Example: `SENSe:FREQuency:STOP? MAX`, **Response:** `3.5E9`
- Numeric values are output without a unit. Physical quantities are referred to the basic units or to the units set using the `Unit` command. The response `3.5E9` in the previous example stands for 3.5 GHz.
- Truth values (Boolean values) are returned as 0 (for OFF) and 1 (for ON).
Example:
Setting command: `HCOPY:DEV:COL ON`
Query: `HCOPY:DEV:COL?`
Response: `1`
- Text (character data) is returned in a short form.
Example:
Setting command: `HCOPY:PAGE:ORIENTATION LANDscape`
Query: `HCOP:PAGE:ORI?`
Response: `LAND`
- Invalid numerical results
In some cases, particularly when a result consists of multiple numeric values, invalid values are returned as `9.91E37` (not a number).

A.2 Command Sequence and Synchronization

IEEE 488.2 defines a distinction between overlapped (asynchronous) and sequential commands:

- A sequential command finishes executing before the next command starts executing. Commands that are processed quickly are usually implemented as sequential commands.
- An overlapping or asynchronous command does not automatically finish executing before the next command starts executing. Usually, overlapping commands take longer to process and allow the program to do other tasks while being executed. If overlapping commands must be executed in a defined order, e.g. to avoid wrong measurement results, they must be serviced sequentially. This method is called synchronization between the controller and the instrument.



As a rule, send commands and queries in different program messages, i.e. in separate command lines.

Do not combine queries with commands that affect the queried value in one program message because the response to the query is not predictable.

The following messages always return correct results:

```
:CHAN:SCAL 0.01;POS 1
```

```
:CHAN:SCAL?
```

Result: 0.01 (10 mV/div)

Reason: Setting commands within one command line, even though they are implemented as sequential commands, are not necessarily serviced in the order in which they have been received.

For further information, refer to:

- rohde-schwarz.com/rckb: Rohde & Schwarz web page that provides information on instrument drivers and remote control.
- "Automatic Measurement Control - A tutorial on SCPI and IEEE 488.2" from John M. Pieper (R&S order number 0002.3536.00). The book offers detailed information on concepts and definitions of SCPI.

A.2.1 Preventing Overlapping Execution

To prevent an overlapping execution of commands, one of the commands `*OPC`, `*OPC?` or `*WAI` can be used. All three commands cause a certain action only to be carried out after the hardware has been set. The controller can be forced to wait for the corresponding action to occur.

Table A-4: Synchronization using *OPC, *OPC? and *WAI

| Com-
mand | Action | Programming the controller |
|--------------|--|---|
| *OPC | Sets the Operation Complete bit in the ESR after all previous commands have been executed. | <ul style="list-style-type: none"> Setting bit 0 in the ESE Setting bit 5 in the SRE Waiting for service request (SRQ) |
| *OPC? | Stops command processing until 1 is returned. This occurs when all pending operations are completed. | Send *OPC? directly after the command whose processing must be terminated before other commands can be executed. |
| *WAI | Stops further command processing until all commands sent before *WAI have been executed. | Send *WAI directly after the command whose processing must be terminated before other commands are executed. |

Command synchronization using *WAI or *OPC? is a good choice if the overlapped command takes only little time to process. The two synchronization commands simply block overlapped execution of the command. Append the synchronization command to the overlapping command, for example:

```
SINGLE; *OPC?
```

For time consuming overlapped commands, you can allow the controller or the instrument to do other useful work while waiting for command execution. Use one of the following methods:

***OPC with a service request**

1. Set the OPC mask bit (bit no. 0) in the ESE: *ESE 1
2. Set bit no. 5 in the SRE: *SRE 32 to enable ESB service request.
3. Send the overlapped command with *OPC .
4. Wait for a service request.

The service request indicates that the overlapped command has finished.

***OPC? with a service request**

1. Set bit no. 4 in the SRE: *SRE 16 to enable MAV service request.
2. Send the overlapped command with *OPC?.
3. Wait for a service request.

The service request indicates that the overlapped command has finished.

Event status register (ESE)

1. Set the OPC mask bit (bit no. 0) in the ESE: *ESE 1
2. Send the overlapped command without *OPC, *OPC? or *WAI.

3. Poll the operation complete state periodically (with a timer) using the sequence:
*OPC; *ESR?

A return value (LSB) of 1 indicates that the overlapped command has finished.

A.3 Messages

A.3.1 Instrument Messages

Instrument messages are employed in the same way for all interfaces, if not indicated otherwise in the description.

There are different types of instrument messages, depending on the direction they are sent:

- Commands
- Instrument responses

Structure and syntax of the instrument messages are described in [Chapter A.1, "SCPI Command Structure"](#), on page 772.

Commands

Commands (program messages) are messages that the controller sends to the instrument. They operate the instrument functions and request information. The commands are subdivided according to two criteria:

- According to the effect on the instrument:
 - **Setting commands** cause instrument settings such as a reset of the instrument or setting the frequency.
 - **Queries** cause data to be provided for remote control, e.g. for identification of the instrument or polling a parameter value. Queries are formed by directly appending a question mark to the command header.
- According to their definition in standards:
 - **Common commands**: their function and syntax are precisely defined in standard IEEE 488.2. They are employed identically on all instruments (if implemented). They refer to functions such as management of the standardized status registers, reset and self-test.
 - **Instrument control commands** refer to functions depending on the features of the instrument such as frequency settings. Many of these commands have also been standardized by the SCPI committee. These commands are marked as "SCPI compliant" in the command reference chapters. Commands without this SCPI label are device-specific, however, their syntax follows SCPI rules as permitted by the standard.

Instrument responses

Instrument responses (response messages and service requests) are messages that the instrument sends to the controller after a query. They can contain measurement results, instrument settings and information on the instrument status.

A.3.2 LAN Interface Messages

In the LAN connection, the interface messages are called low-level control messages. These messages can be used to emulate interface messages of the GPIB bus.

| Command | Long term | Effect on the instrument |
|---------|-----------------------|--|
| &ABO | Abort | Aborts processing of the commands just received. |
| &DCL | Device Clear | Aborts processing of the commands just received and sets the command processing software to a defined initial state. Does not change the instrument setting. |
| >L | Go to Local | Transition to the "local" state (manual control). (The instrument automatically returns to remote state when a remote command is sent UNLESS &NREN was sent before.) |
| >R | Go to Remote | Enables automatic transition from local state to remote state by a subsequent remote command (after &NREN was sent). |
| &GET | Group Execute Trigger | Triggers a previously active instrument function (e.g. a sweep). The effect of the command is the same as with that of a pulse at the external trigger signal input. |
| &LLO | Local Lockout | Disables transition from remote control to manual control by means of the front panel keys. |
| &NREN | Not Remote Enable | Disables automatic transition from local state to remote state by a subsequent remote command. (To re-activate automatic transition use >R.) |
| &POL | Serial Poll | Starts a serial poll. |

B Remote Control - Status Reporting System

The status reporting system stores all information on the current operating state of the instrument, and on errors which have occurred. This information is stored in the status registers and in the error queue. Both can be queried via GPIB bus or LAN interface (STATus... commands).

B.1 Structure of a SCPI Status Register

Each standard SCPI register consists of 5 parts. Each part has a width of 16 bits and has different functions. The individual bits are independent of each other, i.e. each hardware status is assigned a bit number which is valid for all five parts. Bit 15 (the most significant bit) is set to zero for all parts. Thus the contents of the register parts can be processed by the controller as positive integers.

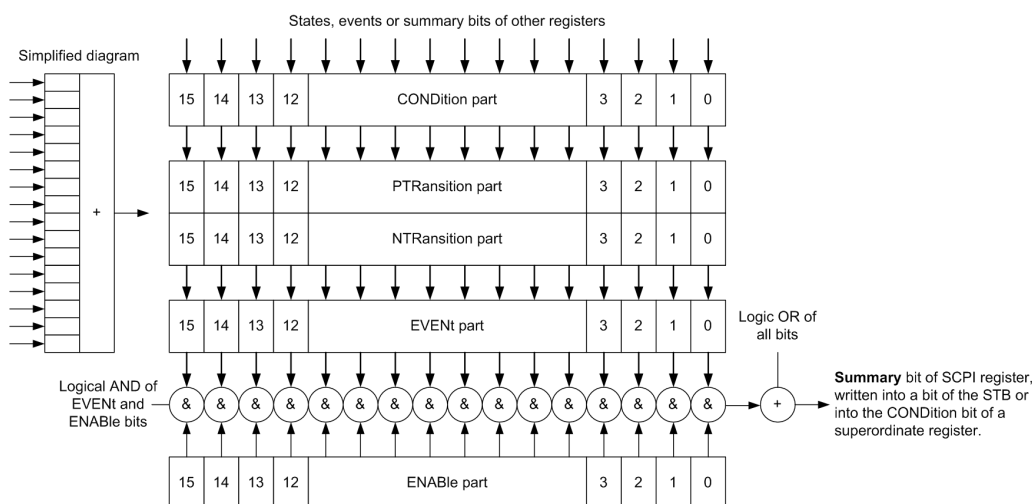

Figure B-1: The status-register model

Description of the five status register parts

The five parts of a SCPI register have different properties and functions:

- CONDition**
 The CONDition part is written into directly by the hardware or the sum bit of the next lower register. Its contents reflect the current instrument status. This register part can only be read, but not written into or cleared. Its contents are not affected by reading.
- PTRansition / NTRansition**
 The two transition register parts define which state transition of the CONDition part (none, 0 to 1, 1 to 0 or both) is stored in the EVENT part.
 The **Positive-TTransition** part acts as a transition filter. When a bit of the CONDition part is changed from 0 to 1, the associated PTR bit decides whether the EVENT bit is set to 1.

- PTR bit =1: the `EVENTt` bit is set.
- PTR bit =0: the `EVENTt` bit is not set.

This part can be written into and read as required. Its contents are not affected by reading.

The **Negative-TRansition** part also acts as a transition filter. When a bit of the `CONDition` part is changed from 1 to 0, the associated `NTR` bit decides whether the `EVENTt` bit is set to 1.

- NTR bit =1: the `EVENTt` bit is set.
- NTR bit =0: the `EVENTt` bit is not set.

This part can be written into and read as required. Its contents are not affected by reading.

- **EVENTt**

The `EVENTt` part indicates whether an event has occurred since the last reading, it is the "memory" of the condition part. It only indicates events passed on by the transition filters. It is permanently updated by the instrument. This part can only be read by the user. Reading the register clears it. This part is often equated with the entire register.

- **ENABLE**

The `ENABLE` part determines whether the associated `EVENTt` bit contributes to the sum bit (see below). Each bit of the `EVENTt` part is "ANDed" with the associated `ENABLE` bit (symbol '&'). The results of all logical operations of this part are passed on to the sum bit via an "OR" function (symbol '+').

`ENABLE` bit = 0: the associated `EVENTt` bit does not contribute to the sum bit

`ENABLE` bit = 1: if the associated `EVENTt` bit is "1", the sum bit is set to "1" as well.

This part can be written into and read by the user as required. Its contents are not affected by reading.

Sum bit

The sum bit is obtained from the `EVENTt` and `ENABLE` part for each register. The result is then entered into a bit of the `CONDition` part of the higher-order register.

The instrument automatically generates the sum bit for each register. Thus an event can lead to a service request throughout all levels of the hierarchy.

B.2 Hierarchy of status registers

As shown in the following figure, the status information is of hierarchical structure.

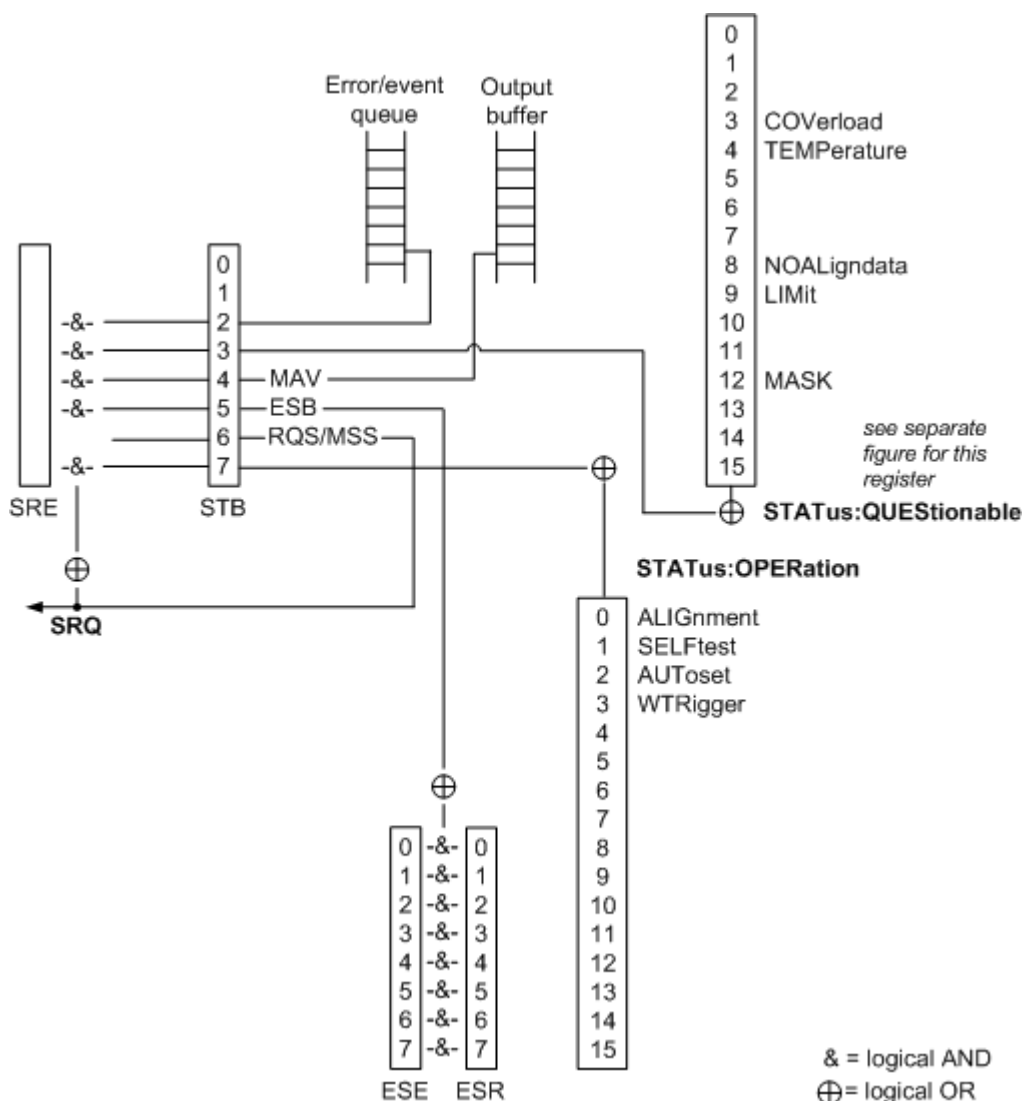

Figure B-2: Overview of the status registers hierarchy

- **STB, SRE**
The SStatus Byte (STB) register and its associated mask register Service Request Enable (SRE) form the highest level of the status reporting system. The STB provides a rough overview of the instrument status, collecting the information of the lower-level registers.
- **ESR, SCPI registers**
The STB receives its information from the following registers:
 - The Event Status Register (ESR) with the associated mask register standard Event Status Enable (ESE).
 - The STATUS:OPERation and STATUS:QUESTionable registers which are defined by SCPI and contain detailed information on the instrument.
- **Output buffer**

The output buffer contains the messages the instrument returns to the controller. It is not part of the status reporting system but determines the value of the `MAV` bit in the `STB` and thus is represented in the overview.

All status registers have the same internal structure.



SRE, ESE

The service request enable register `SRE` can be used as `ENABLE` part of the `STB` if the `STB` is structured according to SCPI. By analogy, the `ESE` can be used as the `ENABLE` part of the `ESR`.

B.3 Contents of the Status Registers

In the following sections, the contents of the status registers are described in more detail.

B.3.1 Status Byte (STB) and Service Request Enable Register (SRE)

The `Status Byte` (STB) is already defined in IEEE 488.2. It provides a rough overview of the instrument status by collecting the pieces of information of the lower registers. A special feature is that bit 6 acts as the sum bit of the remaining bits of the status byte.

The STB can thus be compared with the `CONDition` part of an SCPI register and assumes the highest level within the SCPI hierarchy.

The STB is read using the command `*STB?` or a serial poll.

The `Status Byte` (STB) is linked to the `Service Request Enable` (SRE) register. Each bit of the STB is assigned a bit in the SRE. Bit 6 of the SRE is ignored. If a bit is set in the SRE and the associated bit in the STB changes from 0 to 1, a service request (SRQ) is generated. The SRE can be set using the command `*SRE` and read using the command `*SRE?`.

Table B-1: Meaning of the bits used in the status byte

| Bit No. | Meaning |
|---------|--|
| 0...1 | Not used |
| 2 | Error Queue not empty
The bit is set when an entry is made in the error queue. If this bit is enabled by the SRE, each entry of the error queue generates a service request. Thus an error can be recognized and specified in greater detail by polling the error queue. The poll provides an informative error message. This procedure is to be recommended since it considerably reduces the problems involved with remote control. |
| 3 | QUESTIONable status register summary bit
The bit is set if an <code>EVENT</code> bit is set in the <code>QUESTIONable</code> status register and the associated <code>ENABLE</code> bit is set to 1. A set bit indicates a questionable instrument status, which can be specified in greater detail by querying the <code>STATus:QUESTIONable</code> status register. |

| Bit No. | Meaning |
|---------|--|
| 4 | MAV bit (message available)
The bit is set if a message is available in the output queue which can be read. This bit can be used to enable data to be automatically read from the instrument to the controller. |
| 5 | ESB bit
Sum bit of the event status register. It is set if one of the bits in the event status register is set and enabled in the event status enable register. Setting of this bit indicates a serious error which can be specified in greater detail by polling the event status register. |
| 6 | MSS bit (master status summary bit)
The bit is set if the instrument triggers a service request. This is the case if one of the other bits of this registers is set together with its mask bit in the service request enable register SRE. |
| 7 | STATUS:OPERation status register summary bit
The bit is set if an EVENT bit is set in the OPERATION status register and the associated ENABLE bit is set to 1. A set bit indicates that the instrument is just performing an action. The type of action can be determined by querying the STATUS:OPERation status register. |

B.3.2 Event Status Register (ESR) and Event Status Enable Register (ESE)

The ESR is defined in IEEE 488.2. It can be compared with the EVENT part of a SCPI register. The event status register can be read out using command *ESR?.

The ESE corresponds to the ENABLE part of a SCPI register. If a bit is set in the ESE and the associated bit in the ESR changes from 0 to 1, the ESB bit in the STB is set. The ESE register can be set using the command *ESE and read using the command *ESE?.

Table B-2: Meaning of the bits used in the event status register

| Bit No. | Meaning |
|---------|---|
| 0 | Operation Complete
This bit is set on receipt of the command *OPC exactly when all previous commands have been executed. |
| 1 | Not used |
| 2 | Query Error
This bit is set if either the controller wants to read data from the instrument without having sent a query, or if it does not fetch requested data and sends new instructions to the instrument instead. The cause is often a query which is faulty and hence cannot be executed. |
| 3 | Device-dependent Error
This bit is set if a device-dependent error occurs. An error message with a number between -300 and -399 or a positive error number, which denotes the error in greater detail, is entered into the error queue. |
| 4 | Execution Error
This bit is set if a received command is syntactically correct but cannot be performed for other reasons. An error message with a number between -200 and -300, which denotes the error in greater detail, is entered into the error queue. |

| Bit No. | Meaning |
|---------|---|
| 5 | Command Error
This bit is set if a command is received, which is undefined or syntactically incorrect. An error message with a number between -100 and -200, which denotes the error in greater detail, is entered into the error queue. |
| 6 | User Request
This bit is set when the instrument is switched over to manual control. |
| 7 | Power On (supply voltage on)
This bit is set on switching on the instrument. |

B.3.3 STATUS:OPERation Register

In the `CONDition` part, this register contains information on which actions the instrument is being executing. In the `EVENT` part, it contains information on which actions the instrument has executed since the last reading. It can be read using the commands `STATUS:OPERation:CONDition?` or `STATUS:OPERation[:EVENT]?`.

See also: [Figure B-2](#)

The remote commands for the `STATUS:OPERation` register are described in [Chapter 16.15.1, "STATUS:OPERation Register"](#), on page 764.

Table B-3: Bits in the STATUS:OPERation register

| Bit No. | Meaning |
|---------|---|
| 0 | <code>ALIGNment</code>
This bit is set as long as the instrument is performing a self alignment. |
| 1 | <code>SELFtest</code>
This bit is set while the selftest is running. |
| 2 | <code>AUTOset</code>
This bit is set while the instrument is performing an auto setup. |
| 3 | <code>WTRigger</code>
This bit is set while the instrument is waiting for the trigger. |
| 4 to 14 | Not used |
| 15 | This bit is always 0. |

B.3.4 STATUS:QUESTionable Register

This register contains information about indefinite states which may occur if the unit is operated without meeting the specifications. It can be read using the commands `STATUS:QUESTionable:CONDition?` on page 767 and `STATUS:QUESTionable[:EVENT]?` on page 768

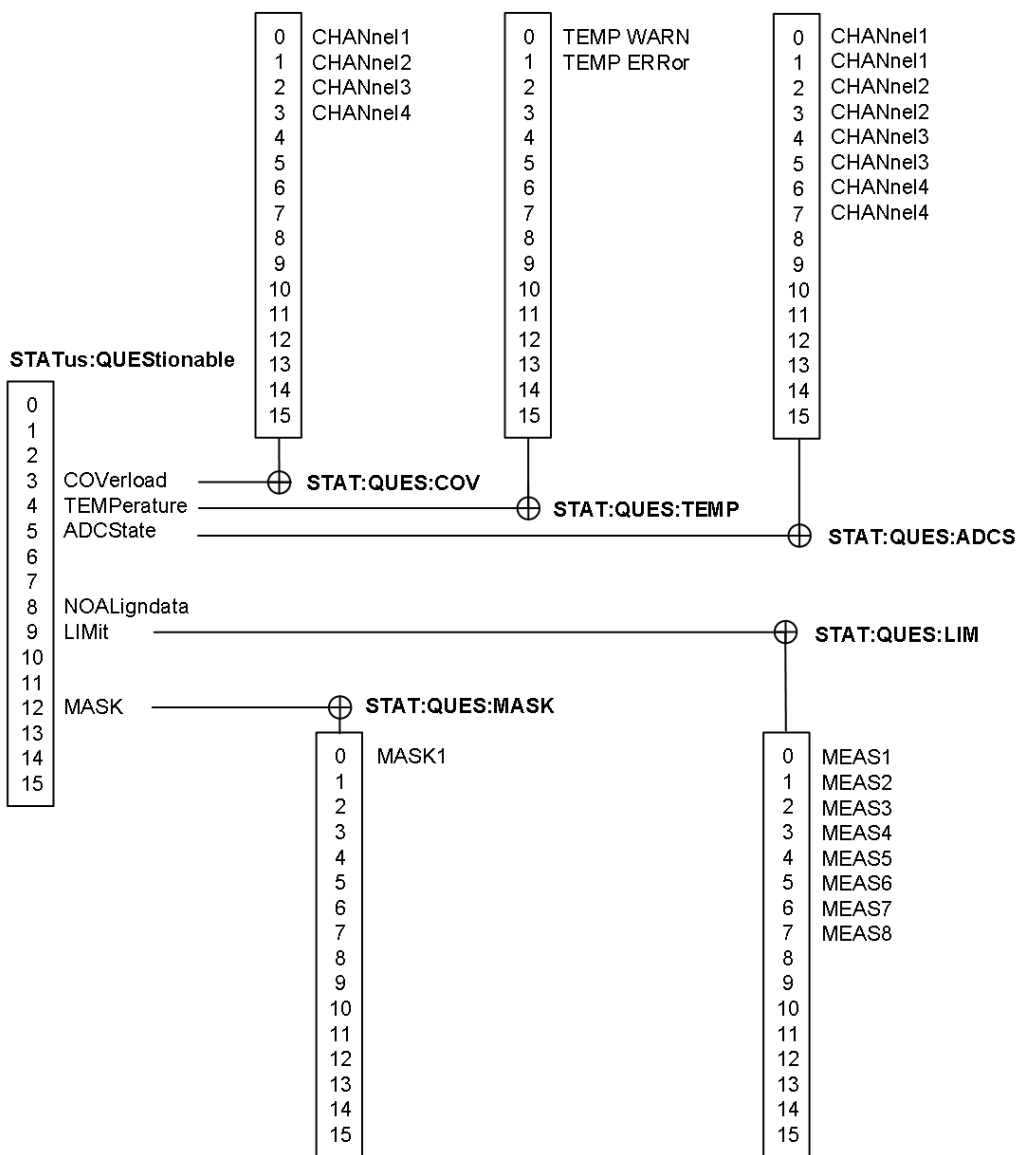

Figure B-3: Overview of the STATUS:QUESTIONABLE register

Table B-4: Bits in the STATUS:QUESTIONABLE register

| Bit No. | Meaning |
|---------|--|
| 0 to 2 | not used |
| 3 | COVerload
This bit is set if a questionable channel overload occurs (see Chapter B.3.4.1, "STATUS:QUESTIONABLE:COVerload register", on page 791). |
| 4 | TEMPerature
This bit is set if a questionable temperature occurs (see Chapter B.3.4.2, "STATUS:QUESTIONABLE:TEMPerature register", on page 791). |

| Bit No. | Meaning |
|----------|--|
| 5 | ADCState
The bit is set if the signal is clipped on the upper or lower edge of the screen - overflow of the ADC occurs (see Chapter B.3.4.3, "STATUS:QUESTIONable:ADCState Register" , on page 792). |
| 6 to 7 | Not used |
| 8 | NOALigndata
This bit is set if no alignment data is available - the instrument is uncalibrated. |
| 9 | LIMit
This bit is set if a limit value is violated (see Chapter B.3.4.4, "STATUS:QUESTIONable:LIMit register" , on page 792). |
| 10 to 11 | Not used |
| 12 | MASK
This bit is set if a mask value is violated (see Chapter B.3.4.5, "STATUS:QUESTIONable:MASK register" , on page 792 |
| 13 to 14 | Not used |
| 15 | This bit is always 0. |

B.3.4.1 STATUS:QUESTIONable:COVerload register

This register contains all information about overload of the channels. The bit is set if the assigned channel is overloaded.

Table B-5: Bits in the STATUS:QUESTIONable:COVerload register

| Bit No. | Meaning |
|---------|----------|
| 0 | CHANnel1 |
| 1 | CHANnel2 |
| 2 | CHANnel3 |
| 3 | CHANnel4 |

B.3.4.2 STATUS:QUESTIONable:TEMPerature register

This register contains information about the instrument's temperature.

Table B-6: Bits in the STATUS:QUESTIONable:TEMPerature register

| Bit No. | Meaning |
|---------|---|
| 0 | TEMP WARN
This bit is set if a temperature warning on channel 1, 2, 3 or 4 occurred. |
| 1 | TEMP ERROr
This bit is set if a temperature error on channel 1, 2, 3 or 4 occurred. |

B.3.4.3 STATus:QUEStionable:ADCState Register

This register contains all information about overflow of the ADC.

The bit is set if the assigned channel signal is clipped on the upper or lower edge of the screen. In this case, the signal does not fit in the range of the ADC and overflow occurs.

Table B-7: Bits in the STATus:QUEStionable:ADCState register

| Bit No. | Meaning |
|---------|---------------------------------------|
| 0 | CHANnel1, clipping on the upper limit |
| 1 | CHANnel1, clipping on the lower limit |
| 2 | CHANnel2, clipping on the upper limit |
| 3 | CHANnel2, clipping on the lower limit |
| 4 | CHANnel3, clipping on the upper limit |
| 5 | CHANnel3, clipping on the lower limit |
| 6 | CHANnel4, clipping on the upper limit |
| 7 | CHANnel4, clipping on the lower limit |

B.3.4.4 STATus:QUEStionable:LIMit register

This register contains information about the observance of the limits of measurements. This bit is set if the limits of the assigned measurement are violated.

Table B-8: Bits in the STATus:QUEStionable:LIMit register

| Bit No. | Meaning |
|---------|---------|
| 0 | MEAS1 |
| 1 | MEAS2 |
| 2 | MEAS3 |
| 3 | MEAS4 |
| 4 | MEAS5 |
| 5 | MEAS6 |
| 6 | MEAS7 |
| 7 | MEAS8 |

B.3.4.5 STATus:QUEStionable:MASK register

This register contains information about the violation of masks. This bit is set if the assigned mask is violated.

Table B-9: Bits in the STATus:QUEStionable:MASK register

| Bit No. | Meaning |
|---------|---------|
| 0 | MASK1 |

B.4 Application of the Status Reporting System

The purpose of the status reporting system is to monitor the status of one or several devices in a measuring system. To do this and react appropriately, the controller must receive and evaluate the information of all devices. The following standard methods are used:

- **Service request** (SRQ) initiated by the instrument
- **Serial poll** of all devices in the bus system, initiated by the controller in order to find out who sent a SRQ and why
- **Parallel poll** of all devices
- Query of a **specific instrument status** by means of commands
- Query of the **error queue**

B.4.1 Service Request

Under certain circumstances, the instrument can send a service request (SRQ) to the controller. Usually this service request initiates an interrupt at the controller, to which the control program can react appropriately. As evident from [Figure B-2](#), an SRQ is always initiated if one or several of bits 2, 3, 4, 5 or 7 of the status byte are set and enabled in the SRE. Each of these bits combines the information of a further register, the error queue or the output buffer. The `ENABLE` parts of the status registers can be set such that arbitrary bits in an arbitrary status register initiate an SRQ. In order to make use of the possibilities of the service request effectively, all bits should be set to "1" in enable registers SRE and ESE.

The SRQ is the only possibility for the instrument to become active on its own. Each controller program should cause the instrument to initiate a service request if errors occur. The program should react appropriately to the service request.

B.4.2 Serial Poll

In a serial poll, just as with command `*STB`, the status byte of an instrument is queried. However, the query is realized via interface messages and is thus clearly faster.

The serial poll method is defined in IEEE 488.1 and used to be the only standard possibility for different instruments to poll the status byte. The method also works for instruments which do not adhere to SCPI or IEEE 488.2.

The serial poll is mainly used to obtain a fast overview of the state of several instruments connected to the controller.

B.4.3 Query of an instrument status

Each part of any status register can be read using queries. There are two types of commands:

- The common commands `*ESR?`, `*IDN?`, `*IST?`, `*STB?` query the higher-level registers.
- The commands of the `STATus` system query the SCPI registers (`STATus:QUEStionable...`)

The returned value is always a decimal number that represents the bit pattern of the queried register. This number is evaluated by the controller program.

Queries are usually used after an SRQ in order to obtain more detailed information on the cause of the SRQ.

B.4.3.1 Decimal representation of a bit pattern

The STB and ESR registers contain 8 bits, the SCPI registers 16 bits. The contents of a status register are specified and transferred as a single decimal number. To make this possible, each bit is assigned a weighted value. The decimal number is calculated as the sum of the weighted values of all bits in the register that are set to 1.

| | | | | | | | | | |
|--------|---|---|---|---|----|----|----|-----|-----|
| Bits | 0 | 1 | 2 | 3 | 4 | 5 | 6 | 7 | ... |
| Weight | 1 | 2 | 4 | 8 | 16 | 32 | 64 | 128 | ... |

Example:

The decimal value $40 = 32 + 8$ indicates that bits no. 3 and 5 in the status register (e.g. the `QUEStionable` status summary bit and the `ESB` bit in the `STatus Byte`) are set.

B.4.4 Error Queue

Each error state in the instrument leads to an entry in the error queue. The entries of the error queue are detailed plain text error messages that can be looked up in the Error Log or queried via remote control using `SYSTem:ERRor[:NEXT]?`. Each call of `SYSTem:ERRor[:NEXT]?` provides one entry from the error queue. If no error messages are stored there any more, the instrument responds with 0, "No error".

The error queue should be queried after every SRQ in the controller program as the entries describe the cause of an error more precisely than the status registers. Especially in the test phase of a controller program the error queue should be queried regularly since faulty commands from the controller to the instrument are recorded there as well.

B.5 Reset Values of the Status Reporting System

The following table contains the different commands and events causing the status reporting system to be reset. None of the commands, except *RST and SYSTem:PRESet, influence the functional instrument settings. In particular, DCL does not change the instrument settings.

Table B-10: Reset of the status reporting system

| Event | Switching on supply voltage
Power-On-Status-Clear | | DCL,
SDC
(Device
Clear,
Selected
Device
Clear) | *RST or
SYS-
Tem:PRE
Set | STA-
Tus:PRE-
Set | *CLS |
|---|--|-----|--|-----------------------------------|-------------------------|------|
| | 0 | 1 | | | | |
| Clear STB, ESR | - | yes | - | - | - | yes |
| Clear SRE, ESE | - | yes | - | - | - | - |
| Clear EVENT parts of the registers | - | yes | - | - | - | yes |
| Clear ENABLE parts of all OPERation and QUEStionable registers;
Fill ENABLE parts of all other registers with "1". | - | yes | - | - | yes | - |
| Fill PTRansition parts with "1";
Clear NTRansition parts | - | yes | - | - | yes | - |
| Clear error queue | yes | yes | - | - | - | yes |
| Clear output buffer | yes | yes | yes | 1) | 1) | 1) |
| Clear command processing and input buffer | yes | yes | yes | - | - | - |

1) The first command in a command line that immediately follows a <PROGRAM MESSAGE TERMINATOR> clears the output buffer.

List of Commands

| | |
|--|-----|
| *CAL? | 411 |
| *CLS | 412 |
| *ESE | 412 |
| *ESR? | 412 |
| *IDN? | 412 |
| *OPC | 412 |
| *OPT? | 413 |
| *PSC | 413 |
| *RST | 413 |
| *SRE | 413 |
| *STB? | 414 |
| *TRG | 414 |
| *WAI | 414 |
| ACQUIRE:AVAILABLE? | 478 |
| ACQUIRE:AVERAge:COMPLete? | 434 |
| ACQUIRE:AVERAge:COUNt | 433 |
| ACQUIRE:AVERAge:CURREnt? | 478 |
| ACQUIRE:AVERAge:RESEt | 433 |
| ACQUIRE:COUNt | 478 |
| ACQUIRE:HRESolution | 433 |
| ACQUIRE:INTERpolate | 434 |
| ACQUIRE:MEMory[:MODE] | 476 |
| ACQUIRE:NSINGLE:COUNt | 415 |
| ACQUIRE:NSINGLE:COUNt | 433 |
| ACQUIRE:NSINGLE:COUNt | 478 |
| ACQUIRE:PEAKdetect | 433 |
| ACQUIRE:POINts:ARATE? | 435 |
| ACQUIRE:POINts:AUTomatic | 431 |
| ACQUIRE:POINts:AUTomatic | 477 |
| ACQUIRE:POINts[:VALue] | 431 |
| ACQUIRE:POINts[:VALue] | 477 |
| ACQUIRE:SEGMENTed:STATE | 478 |
| ACQUIRE:SRATE? | 435 |
| ACQUIRE:STATE | 416 |
| AUToscale | 415 |
| BPLot:AMPLitude:ENABle | 536 |
| BPLot:AMPLitude:MODE | 532 |
| BPLot:AMPLitude:POSition | 536 |
| BPLot:AMPLitude:PROFile:COUNt | 532 |
| BPLot:AMPLitude:PROFile:POINt<n>:AMPLitude | 532 |
| BPLot:AMPLitude:PROFile:POINt<n>:FREQuency | 532 |
| BPLot:AMPLitude:SCALE | 537 |
| BPLot:ENABle | 532 |
| BPLot:EXPort:NAME | 486 |
| BPLot:EXPort:SAVE | 487 |
| BPLot:FREQuency:DATA? | 533 |
| BPLot:FREQuency:STARt | 533 |

| | |
|--|-----|
| BPLot:FREQuency:STOP..... | 533 |
| BPLot:GAIN:DATA?..... | 535 |
| BPLot:GAIN:ENABle..... | 535 |
| BPLot:GAIN:POSition..... | 535 |
| BPLot:GAIN:SCALe..... | 535 |
| BPLot:INPut[:SOURce]..... | 533 |
| BPLot:MARKer<m>:DIFFerence:FREQ?..... | 537 |
| BPLot:MARKer<m>:DIFFerence:GAIN?..... | 537 |
| BPLot:MARKer<m>:DIFFerence:PHASe?..... | 537 |
| BPLot:MARKer<m>:FREQuency..... | 538 |
| BPLot:MARKer<m>:GAIN?..... | 538 |
| BPLot:MARKer<m>:INDex..... | 538 |
| BPLot:MARKer<m>:PHASe?..... | 538 |
| BPLot:MARKer<m>:SSCReen..... | 539 |
| BPLot:MEASurement:DELay..... | 533 |
| BPLot:MEASurement:POINT[:DISPLAY]..... | 533 |
| BPLot:OUTPut[:SOURce]..... | 534 |
| BPLot:PHASe:DATA?..... | 535 |
| BPLot:PHASe:ENABle?..... | 536 |
| BPLot:PHASe:POSition?..... | 536 |
| BPLot:PHASe:SCALe?..... | 536 |
| BPLot:POINts:LOGarithmic..... | 534 |
| BPLot:REPeat..... | 534 |
| BPLot:RESet..... | 534 |
| BPLot:STATe..... | 534 |
| BUS:ARINc:BRMode..... | 672 |
| BUS:ARINc:BRValue..... | 672 |
| BUS:ARINc:DATA:FORMat..... | 677 |
| BUS:ARINc:POLarity..... | 672 |
| BUS:ARINc:SOURce..... | 672 |
| BUS:ARINc:THReshold:HIGH..... | 673 |
| BUS:ARINc:THReshold:LOW..... | 673 |
| BUS:ARINc:WCOut?..... | 677 |
| BUS:ARINc:WORD<n>:DATA[:VALue]?..... | 678 |
| BUS:ARINc:WORD<n>:FORMat?..... | 678 |
| BUS:ARINc:WORD<n>:LABel[:VALue]?..... | 678 |
| BUS:ARINc:WORD<n>:PARity?..... | 678 |
| BUS:ARINc:WORD<n>:PATtern?..... | 679 |
| BUS:ARINc:WORD<n>:SDI?..... | 679 |
| BUS:ARINc:WORD<n>:SSM?..... | 679 |
| BUS:ARINc:WORD<n>:STARt?..... | 679 |
| BUS:ARINc:WORD<n>:STATus?..... | 680 |
| BUS:ARINc:WORD<n>:STOP?..... | 680 |
| BUS:CAN:BITRate..... | 610 |
| BUS:CAN:DATA:SOURce..... | 609 |
| BUS:CAN:FCOut?..... | 614 |
| BUS:CAN:FRAMe<n>:ACKState?..... | 616 |
| BUS:CAN:FRAMe<n>:ACKValue?..... | 616 |
| BUS:CAN:FRAMe<n>:BCOut?..... | 619 |
| BUS:CAN:FRAMe<n>:BSEPosition?..... | 619 |

| | |
|------------------------------------|-----|
| BUS:CAN:FRAMe<n>:BYTE<o>:STATe? | 619 |
| BUS:CAN:FRAMe<n>:BYTE<o>:VALue? | 620 |
| BUS:CAN:FRAMe<n>:CSSTate? | 617 |
| BUS:CAN:FRAMe<n>:CSValue? | 617 |
| BUS:CAN:FRAMe<n>:DATA? | 616 |
| BUS:CAN:FRAMe<n>:DLCState? | 617 |
| BUS:CAN:FRAMe<n>:DLCValue? | 618 |
| BUS:CAN:FRAMe<n>:IDSTate? | 618 |
| BUS:CAN:FRAMe<n>:IDTpe? | 618 |
| BUS:CAN:FRAMe<n>:IDValue? | 618 |
| BUS:CAN:FRAMe<n>:STARt? | 615 |
| BUS:CAN:FRAMe<n>:STATus? | 615 |
| BUS:CAN:FRAMe<n>:STOP? | 616 |
| BUS:CAN:FRAMe<n>:TYPE? | 614 |
| BUS:CAN:SAMPlepoint | 610 |
| BUS:CAN:TYPE | 609 |
| BUS:CPARallel:CLOCK:SLOPe | 745 |
| BUS:CPARallel:CLOCK:SOURce | 745 |
| BUS:CPARallel:CS:ENABle | 745 |
| BUS:CPARallel:CS:POLarity | 746 |
| BUS:CPARallel:CS:SOURce | 746 |
| BUS:CPARallel:DATA<m>:SOURce | 744 |
| BUS:CPARallel:FCOunt? | 747 |
| BUS:CPARallel:FRAMe<n>:DATA? | 747 |
| BUS:CPARallel:FRAMe<n>:STARt? | 747 |
| BUS:CPARallel:FRAMe<n>:STATe? | 747 |
| BUS:CPARallel:FRAMe<n>:STOP? | 748 |
| BUS:CPARallel:WIDTh | 744 |
| BUS:DSIGnals | 575 |
| BUS:DSIZe | 575 |
| BUS:FORMat | 575 |
| BUS:HISTory:CONTRol:ENABle] | 480 |
| BUS:HISTory:CURRent | 480 |
| BUS:HISTory:EXPort:NAME | 486 |
| BUS:HISTory:EXPort:SAVE | 487 |
| BUS:HISTory:PALL | 480 |
| BUS:HISTory:PLAYer:SPEed | 481 |
| BUS:HISTory:PLAYer:STATe | 482 |
| BUS:HISTory:REPLay | 481 |
| BUS:HISTory:STARt | 481 |
| BUS:HISTory:STOP | 481 |
| BUS:HISTory:TSABsolute:ALL? | 485 |
| BUS:HISTory:TSABsolute? | 485 |
| BUS:HISTory:TSDate:ALL? | 486 |
| BUS:HISTory:TSDate? | 485 |
| BUS:HISTory:TSRelative:ALL? | 484 |
| BUS:HISTory:TSRelative? | 484 |
| BUS:HISTory:TTABle[:ENABle] | 483 |
| BUS:I2C:CLOCK:SOURce | 589 |
| BUS:I2C:DATA:SOURce | 589 |

| | |
|--|-----|
| BUS:I2C:FCOunt?..... | 593 |
| BUS:I2C:FRAMe<n>:AACcess?..... | 594 |
| BUS:I2C:FRAMe<n>:ACcess?..... | 594 |
| BUS:I2C:FRAMe<n>:ACOMplete?..... | 595 |
| BUS:I2C:FRAMe<n>:ADBStart?..... | 595 |
| BUS:I2C:FRAMe<n>:ADDRes?..... | 595 |
| BUS:I2C:FRAMe<n>:ADEVice?..... | 596 |
| BUS:I2C:FRAMe<n>:AMODE?..... | 596 |
| BUS:I2C:FRAMe<n>:AStart?..... | 596 |
| BUS:I2C:FRAMe<n>:BCOunt?..... | 597 |
| BUS:I2C:FRAMe<n>:BYTE<o>:ACcess?..... | 597 |
| BUS:I2C:FRAMe<n>:BYTE<o>:ACKStart?..... | 597 |
| BUS:I2C:FRAMe<n>:BYTE<o>:COMplete?..... | 598 |
| BUS:I2C:FRAMe<n>:BYTE<o>:STARt?..... | 598 |
| BUS:I2C:FRAMe<n>:BYTE<o>:VALue?..... | 599 |
| BUS:I2C:FRAMe<n>:DATA?..... | 593 |
| BUS:I2C:FRAMe<n>:STARt?..... | 594 |
| BUS:I2C:FRAMe<n>:STATus?..... | 593 |
| BUS:I2C:FRAMe<n>:STOP?..... | 594 |
| BUS:I2S:AVARiant..... | 637 |
| BUS:I2S:BORDER..... | 637 |
| BUS:I2S:CHANnel:LENGth..... | 638 |
| BUS:I2S:CHANnel:OFFSet..... | 638 |
| BUS:I2S:CHANnel:ORDer..... | 638 |
| BUS:I2S:CHANnel:TDMCount..... | 638 |
| BUS:I2S:CLOCK:POLarity..... | 639 |
| BUS:I2S:CLOCK:SOURce..... | 639 |
| BUS:I2S:CLOCK:THReshold..... | 639 |
| BUS:I2S:DATA:POLarity..... | 639 |
| BUS:I2S:DATA:SOURce..... | 640 |
| BUS:I2S:DATA:THReshold..... | 640 |
| BUS:I2S:DISPlay..... | 640 |
| BUS:I2S:FCOunt?..... | 643 |
| BUS:I2S:FOFFset..... | 641 |
| BUS:I2S:FRAMe<n>:LEFT:STATe?..... | 646 |
| BUS:I2S:FRAMe<n>:LEFT:VALue?..... | 647 |
| BUS:I2S:FRAMe<n>:RIGHT:STATe?..... | 647 |
| BUS:I2S:FRAMe<n>:RIGHT:VALue?..... | 647 |
| BUS:I2S:FRAMe<n>:STARt?..... | 648 |
| BUS:I2S:FRAMe<n>:STATe?..... | 648 |
| BUS:I2S:FRAMe<n>:STOP?..... | 648 |
| BUS:I2S:FRAMe<n>:TDM<o>:STATe?..... | 648 |
| BUS:I2S:FRAMe<n>:TDM<o>:VALue?..... | 649 |
| BUS:I2S:WLENGth..... | 641 |
| BUS:I2S:WSElect:POLarity..... | 641 |
| BUS:I2S:WSElect:SOURce..... | 642 |
| BUS:I2S:WSElect:THReshold..... | 642 |
| BUS:LABel..... | 575 |
| BUS:LABel:STATe..... | 575 |
| BUS:LIN:BITRate..... | 625 |

| | |
|---|-----|
| BUS:LIN:DATA:SOURce..... | 624 |
| BUS:LIN:FCOunt?..... | 629 |
| BUS:LIN:FRAMe<n>:BCOunt?..... | 632 |
| BUS:LIN:FRAMe<n>:BYTE<o>:STATe?..... | 633 |
| BUS:LIN:FRAMe<n>:BYTE<o>:VALue?..... | 633 |
| BUS:LIN:FRAMe<n>:CSSTate?..... | 630 |
| BUS:LIN:FRAMe<n>:CSValue?..... | 630 |
| BUS:LIN:FRAMe<n>:DATA?..... | 629 |
| BUS:LIN:FRAMe<n>:IDPValue?..... | 631 |
| BUS:LIN:FRAMe<n>:IDSTate?..... | 631 |
| BUS:LIN:FRAMe<n>:IDValue?..... | 631 |
| BUS:LIN:FRAMe<n>:START?..... | 629 |
| BUS:LIN:FRAMe<n>:STATus?..... | 629 |
| BUS:LIN:FRAMe<n>:STOP?..... | 630 |
| BUS:LIN:FRAMe<n>:SYSTate?..... | 632 |
| BUS:LIN:FRAMe<n>:SYValue?..... | 632 |
| BUS:LIN:FRAMe<n>:VERSion?..... | 632 |
| BUS:LIN:POLarity..... | 625 |
| BUS:LIN:STANdard..... | 625 |
| BUS:MILStd:IMGTime:INFinite..... | 650 |
| BUS:MILStd:IMGTime:MAXimum..... | 650 |
| BUS:MILStd:IMGTime:MINimum..... | 650 |
| BUS:MILStd:POLarity..... | 650 |
| BUS:MILStd:RESPonsetime:INFinite..... | 650 |
| BUS:MILStd:RESPonsetime:MAXimum..... | 651 |
| BUS:MILStd:RESPonsetime:MINimum..... | 651 |
| BUS:MILStd:SOURce..... | 651 |
| BUS:MILStd:THReshold:HIGH..... | 651 |
| BUS:MILStd:THReshold:LOW..... | 651 |
| BUS:MILStd:WCOunt?..... | 659 |
| BUS:MILStd:WORD<n>:COMMand:MCODE:CODE?..... | 660 |
| BUS:MILStd:WORD<n>:COMMand:MCODE:VALue?..... | 660 |
| BUS:MILStd:WORD<n>:COMMand:RTADdress?..... | 661 |
| BUS:MILStd:WORD<n>:COMMand:SADdress?..... | 661 |
| BUS:MILStd:WORD<n>:COMMand:WCOunt?..... | 661 |
| BUS:MILStd:WORD<n>:DATA?..... | 661 |
| BUS:MILStd:WORD<n>:IMGTime?..... | 662 |
| BUS:MILStd:WORD<n>:PARity?..... | 662 |
| BUS:MILStd:WORD<n>:RTIME?..... | 662 |
| BUS:MILStd:WORD<n>:START?..... | 662 |
| BUS:MILStd:WORD<n>:STATus:BCReceived?..... | 663 |
| BUS:MILStd:WORD<n>:STATus:BUSY?..... | 663 |
| BUS:MILStd:WORD<n>:STATus:DBCaccept?..... | 663 |
| BUS:MILStd:WORD<n>:STATus:INSTrument?..... | 664 |
| BUS:MILStd:WORD<n>:STATus:MERRor?..... | 664 |
| BUS:MILStd:WORD<n>:STATus:RTADdress?..... | 664 |
| BUS:MILStd:WORD<n>:STATus:SREQuest?..... | 664 |
| BUS:MILStd:WORD<n>:STATus:SUBSystem?..... | 665 |
| BUS:MILStd:WORD<n>:STATus:TERMinal?..... | 665 |
| BUS:MILStd:WORD<n>:STATus?..... | 663 |

| | |
|------------------------------------|-----|
| BUS:MILStd:WORD<n>:STOP? | 665 |
| BUS:MILStd:WORD<n>:TRMode? | 665 |
| BUS:MILStd:WORD<n>:TYPE? | 666 |
| BUS:PARAllel:DATA<m>:SOURce | 744 |
| BUS:PARAllel:FCOunt? | 747 |
| BUS:PARAllel:FRAMe<n>:DATA? | 747 |
| BUS:PARAllel:FRAMe<n>:START? | 747 |
| BUS:PARAllel:FRAMe<n>:STATe? | 747 |
| BUS:PARAllel:FRAMe<n>:STOP? | 748 |
| BUS:PARAllel:WIDTh | 744 |
| BUS:POSition | 576 |
| BUS:RESult | 576 |
| BUS:SPI:BORDer | 579 |
| BUS:SPI:CLOCK:POLarity | 578 |
| BUS:SPI:CLOCK:SOURce | 577 |
| BUS:SPI:CS:POLarity | 577 |
| BUS:SPI:CS:SOURce | 577 |
| BUS:SPI:DATA:POLarity | 578 |
| BUS:SPI:DATA:SOURce | 578 |
| BUS:SPI:FCOunt? | 585 |
| BUS:SPI:FRAMe<n>:DATA:MISO? | 586 |
| BUS:SPI:FRAMe<n>:DATA:MOSI? | 586 |
| BUS:SPI:FRAMe<n>:STARt? | 585 |
| BUS:SPI:FRAMe<n>:STATus? | 585 |
| BUS:SPI:FRAMe<n>:STOP? | 586 |
| BUS:SPI:FRAMe<n>:WCOunt? | 587 |
| BUS:SPI:FRAMe<n>:WORD<o>:MISO? | 588 |
| BUS:SPI:FRAMe<n>:WORD<o>:MOSI? | 588 |
| BUS:SPI:FRAMe<n>:WORD<o>:STARt? | 587 |
| BUS:SPI:FRAMe<n>:WORD<o>:STOP? | 587 |
| BUS:SPI:MISO:POLarity | 579 |
| BUS:SPI:MISO:SOURce | 578 |
| BUS:SPI:MOSI:POLarity | 579 |
| BUS:SPI:MOSI:SOURce | 578 |
| BUS:SPI:SSIZe | 579 |
| BUS:SSPI:BITime | 582 |
| BUS:SSPI:BORDer | 582 |
| BUS:SSPI:CLOCK:POLarity | 580 |
| BUS:SSPI:CLOCK:SOURce | 580 |
| BUS:SSPI:DATA:POLarity | 581 |
| BUS:SSPI:DATA:SOURce | 581 |
| BUS:SSPI:MISO:POLarity | 582 |
| BUS:SSPI:MISO:SOURce | 581 |
| BUS:SSPI:MOSI:POLarity | 581 |
| BUS:SSPI:MOSI:SOURce | 581 |
| BUS:SSPI:SSIZe | 582 |
| BUS:STATe | 574 |
| BUS:TYPE | 574 |
| BUS:UART:BAUDrate | 601 |
| BUS:UART:BITime | 602 |

| | |
|--|-----|
| BUS:UART:DATA:POLarity..... | 600 |
| BUS:UART:DATA:SOURce..... | 600 |
| BUS:UART:FCOunt?..... | 604 |
| BUS:UART:FRAMe<n>:STARt?..... | 605 |
| BUS:UART:FRAMe<n>:STATe?..... | 605 |
| BUS:UART:FRAMe<n>:STOP?..... | 605 |
| BUS:UART:FRAMe<n>:WCOunt?..... | 606 |
| BUS:UART:FRAMe<n>:WORD<o>:RXValue?..... | 608 |
| BUS:UART:FRAMe<n>:WORD<o>:SOURce?..... | 606 |
| BUS:UART:FRAMe<n>:WORD<o>:STARt?..... | 607 |
| BUS:UART:FRAMe<n>:WORD<o>:STATe?..... | 606 |
| BUS:UART:FRAMe<n>:WORD<o>:STOP?..... | 608 |
| BUS:UART:FRAMe<n>:WORD<o>:TXValue?..... | 608 |
| BUS:UART:FRAMe<n>:WORD<o>:VALue?..... | 608 |
| BUS:UART:PARity..... | 601 |
| BUS:UART:POLarity..... | 600 |
| BUS:UART:RX:FCOunt?..... | 604 |
| BUS:UART:RX:FRAMe<n>:STARt?..... | 605 |
| BUS:UART:RX:FRAMe<n>:STATe?..... | 605 |
| BUS:UART:RX:FRAMe<n>:STOP?..... | 605 |
| BUS:UART:RX:FRAMe<n>:WCOunt?..... | 606 |
| BUS:UART:RX:FRAMe<n>:WORD<o>:STARt?..... | 607 |
| BUS:UART:RX:FRAMe<n>:WORD<o>:STATe?..... | 606 |
| BUS:UART:RX:FRAMe<n>:WORD<o>:STOP?..... | 608 |
| BUS:UART:RX:FRAMe<n>:WORD<o>:VALue?..... | 608 |
| BUS:UART:RX:SOURce..... | 600 |
| BUS:UART:SBIT..... | 601 |
| BUS:UART:SSIZe..... | 601 |
| BUS:UART:TX:FCOunt?..... | 604 |
| BUS:UART:TX:FRAMe<n>:STARt?..... | 605 |
| BUS:UART:TX:FRAMe<n>:STATe?..... | 605 |
| BUS:UART:TX:FRAMe<n>:STOP?..... | 605 |
| BUS:UART:TX:FRAMe<n>:WCOunt?..... | 606 |
| BUS:UART:TX:FRAMe<n>:WORD<o>:STARt?..... | 607 |
| BUS:UART:TX:FRAMe<n>:WORD<o>:STATe?..... | 606 |
| BUS:UART:TX:FRAMe<n>:WORD<o>:STOP?..... | 608 |
| BUS:UART:TX:FRAMe<n>:WORD<o>:VALue?..... | 608 |
| BUS:UART:TX:SOURce..... | 600 |
| CALCulate:MATH<m>:DATA:HEADer?..... | 545 |
| CALCulate:MATH<m>:DATA:POINts?..... | 545 |
| CALCulate:MATH<m>:DATA:XINCrement?..... | 549 |
| CALCulate:MATH<m>:DATA:XORigin?..... | 548 |
| CALCulate:MATH<m>:DATA:YINCrement?..... | 550 |
| CALCulate:MATH<m>:DATA:YORigin?..... | 549 |
| CALCulate:MATH<m>:DATA:YRESolution?..... | 550 |
| CALCulate:MATH<m>:DATA?..... | 545 |
| CALCulate:MATH<m>:HISTory:CONTRol:ENABle]..... | 480 |
| CALCulate:MATH<m>:HISTory:CURRent..... | 480 |
| CALCulate:MATH<m>:HISTory:PALL..... | 480 |
| CALCulate:MATH<m>:HISTory:PLAYer:SPEEd..... | 481 |

| | |
|---|-----|
| CALCulate:MATH<m>:HISTory:PLAYer:STATe..... | 482 |
| CALCulate:MATH<m>:HISTory:REPLay..... | 481 |
| CALCulate:MATH<m>:HISTory:START..... | 481 |
| CALCulate:MATH<m>:HISTory:STOP..... | 481 |
| CALCulate:MATH<m>:HISTory:TSABsolute:ALL?..... | 485 |
| CALCulate:MATH<m>:HISTory:TSABsolute?..... | 485 |
| CALCulate:MATH<m>:HISTory:TSDate:ALL?..... | 486 |
| CALCulate:MATH<m>:HISTory:TSDate?..... | 485 |
| CALCulate:MATH<m>:HISTory:TSRelative:ALL?..... | 484 |
| CALCulate:MATH<m>:HISTory:TSRelative?..... | 484 |
| CALCulate:MATH<m>:HISTory:TTABLE[:ENABLE]..... | 483 |
| CALCulate:MATH<m>:LABel..... | 454 |
| CALCulate:MATH<m>:LABel:STATe..... | 454 |
| CALCulate:MATH<m>:POSition..... | 455 |
| CALCulate:MATH<m>:SCALE..... | 455 |
| CALCulate:MATH<m>:STATe..... | 453 |
| CALCulate:MATH<m>:TRACK:DPULse[:ENABLE]..... | 456 |
| CALCulate:MATH<m>:TRACK:EDGE..... | 455 |
| CALCulate:MATH<m>:TRACK:THReshold:HYSteresis..... | 456 |
| CALCulate:MATH<m>:TRACK:THReshold:LOWer..... | 456 |
| CALCulate:MATH<m>:TRACK:THReshold[:UPPer]..... | 456 |
| CALCulate:MATH<m>:WCOLor..... | 455 |
| CALCulate:MATH<m>[:EXPRession][:DEFine]..... | 453 |
| CALibration..... | 566 |
| CALibration:STATe?..... | 566 |
| CHANnel<m>:AOFF..... | 417 |
| CHANnel<m>:AON..... | 417 |
| CHANnel<m>:ARITHmetics..... | 432 |
| CHANnel<m>:BANDwidth..... | 419 |
| CHANnel<m>:COUPling..... | 418 |
| CHANnel<m>:DATA:ENVELOpe:HEADer?..... | 544 |
| CHANnel<m>:DATA:ENVELOpe:XINCrement?..... | 549 |
| CHANnel<m>:DATA:ENVELOpe:XORigin?..... | 548 |
| CHANnel<m>:DATA:ENVELOpe:YINCrement?..... | 550 |
| CHANnel<m>:DATA:ENVELOpe:YORigin?..... | 549 |
| CHANnel<m>:DATA:ENVELOpe:YRESolution?..... | 550 |
| CHANnel<m>:DATA:ENVELOpe?..... | 543 |
| CHANnel<m>:DATA:HEADer?..... | 542 |
| CHANnel<m>:DATA:POINts..... | 542 |
| CHANnel<m>:DATA:XINCrement?..... | 549 |
| CHANnel<m>:DATA:XORigin?..... | 548 |
| CHANnel<m>:DATA:YINCrement?..... | 550 |
| CHANnel<m>:DATA:YORigin?..... | 549 |
| CHANnel<m>:DATA:YRESolution?..... | 550 |
| CHANnel<m>:DATA?..... | 541 |
| CHANnel<m>:HISTory:CONTRol[:ENABLE]..... | 480 |
| CHANnel<m>:HISTory:CURRent..... | 480 |
| CHANnel<m>:HISTory:EXPort:NAME..... | 487 |
| CHANnel<m>:HISTory:EXPort:SAVE..... | 487 |
| CHANnel<m>:HISTory:PALL..... | 480 |

| | |
|---|-----|
| CHANnel<m>:HISTory:PLAYer:SPEed..... | 481 |
| CHANnel<m>:HISTory:PLAYer:STATe..... | 482 |
| CHANnel<m>:HISTory:REPLay..... | 482 |
| CHANnel<m>:HISTory:STARt..... | 481 |
| CHANnel<m>:HISTory:STOP..... | 481 |
| CHANnel<m>:HISTory:TMODe..... | 484 |
| CHANnel<m>:HISTory:TSABsolute:ALL?..... | 485 |
| CHANnel<m>:HISTory:TSABsolute?..... | 485 |
| CHANnel<m>:HISTory:TSDate:ALL?..... | 486 |
| CHANnel<m>:HISTory:TSDate?..... | 485 |
| CHANnel<m>:HISTory:TSRelative:ALL?..... | 484 |
| CHANnel<m>:HISTory:TSRelative?..... | 484 |
| CHANnel<m>:HISTory:TTABLE[:ENABle]..... | 483 |
| CHANnel<m>:LABel..... | 422 |
| CHANnel<m>:LABel:STATe..... | 422 |
| CHANnel<m>:OFFSet..... | 418 |
| CHANnel<m>:OVERload..... | 421 |
| CHANnel<m>:POLarity..... | 419 |
| CHANnel<m>:POSition..... | 418 |
| CHANnel<m>:RANGe..... | 417 |
| CHANnel<m>:SCALe..... | 417 |
| CHANnel<m>:SKEW..... | 420 |
| CHANnel<m>:STATe..... | 417 |
| CHANnel<m>:THReshold..... | 421 |
| CHANnel<m>:THReshold:FINDlevel..... | 422 |
| CHANnel<m>:THReshold:HYSteresis..... | 422 |
| CHANnel<m>:TYPE..... | 432 |
| CHANnel<m>:WCOLor..... | 420 |
| CHANnel<m>:ZOFFset[:VALue]..... | 420 |
| CURSor<m>:AOFF..... | 501 |
| CURSor<m>:FUNctioN..... | 501 |
| CURSor<m>:SNPeak<n>..... | 505 |
| CURSor<m>:SOURce..... | 502 |
| CURSor<m>:SPPeak<n>..... | 505 |
| CURSor<m>:SSOURce..... | 503 |
| CURSor<m>:STATe..... | 501 |
| CURSor<m>:SWAVE..... | 504 |
| CURSor<m>:TRACKing:SCALe[:STATe]..... | 504 |
| CURSor<m>:TRACKing[:STATe]..... | 503 |
| CURSor<m>:USSOURce..... | 503 |
| CURSor<m>:X1Position..... | 503 |
| CURSor<m>:X2Position..... | 503 |
| CURSor<m>:XCOupling..... | 504 |
| CURSor<m>:XDELta:INVerse?..... | 506 |
| CURSor<m>:XDELta[:VALue]?..... | 505 |
| CURSor<m>:Y1Position..... | 504 |
| CURSor<m>:Y2Position..... | 504 |
| CURSor<m>:YCOupling..... | 504 |
| CURSor<m>:YDELta:SLOPe?..... | 506 |
| CURSor<m>:YDELta[:VALue]?..... | 506 |

| | |
|--|-----|
| DEvice:MODE..... | 507 |
| DIAGnostic:UPDate:INSTall..... | 573 |
| DIAGnostic:UPDate:TRANsfer:CLOSe..... | 573 |
| DIAGnostic:UPDate:TRANsfer:DATA..... | 573 |
| DIAGnostic:UPDate:TRANsfer:OPEN..... | 573 |
| DIgital<m>:CURRent:STATe:MAXimum?..... | 738 |
| DIgital<m>:CURRent:STATe:MINimum?..... | 738 |
| DIgital<m>:DATA:HEADer?..... | 742 |
| DIgital<m>:DATA:POINts..... | 743 |
| DIgital<m>:DATA:XINCrement?..... | 549 |
| DIgital<m>:DATA:XORigin?..... | 548 |
| DIgital<m>:DATA:YINCrement?..... | 550 |
| DIgital<m>:DATA:YORigin?..... | 549 |
| DIgital<m>:DATA:YRESolution?..... | 550 |
| DIgital<m>:DATA?..... | 742 |
| DIgital<m>:DESKew..... | 740 |
| DIgital<m>:DISPlay..... | 739 |
| DIgital<m>:HISTory:CONTRol:ENABle]..... | 480 |
| DIgital<m>:HISTory:CURRent..... | 480 |
| DIgital<m>:HISTory:EXPort:NAME..... | 486 |
| DIgital<m>:HISTory:EXPort:SAVE..... | 487 |
| DIgital<m>:HISTory:PALL..... | 480 |
| DIgital<m>:HISTory:PLAYer:SPEed..... | 481 |
| DIgital<m>:HISTory:PLAYer:STATe..... | 482 |
| DIgital<m>:HISTory:REPLay..... | 481 |
| DIgital<m>:HISTory:START..... | 481 |
| DIgital<m>:HISTory:STOP..... | 481 |
| DIgital<m>:HISTory:TSABsolute:ALL?..... | 485 |
| DIgital<m>:HISTory:TSABsolute?..... | 485 |
| DIgital<m>:HISTory:TSDate:ALL?..... | 486 |
| DIgital<m>:HISTory:TSDate?..... | 485 |
| DIgital<m>:HISTory:TSRelative:ALL?..... | 484 |
| DIgital<m>:HISTory:TSRelative?..... | 484 |
| DIgital<m>:HISTory:TTABLE[:ENABle]..... | 483 |
| DIgital<m>:HYSTEResis..... | 740 |
| DIgital<m>:LABel..... | 741 |
| DIgital<m>:LABel:STATe..... | 741 |
| DIgital<m>:POSition..... | 741 |
| DIgital<m>:SIZE..... | 740 |
| DIgital<m>:TECHnology..... | 739 |
| DIgital<m>:THCoupling..... | 739 |
| DIgital<m>:THReshold..... | 739 |
| DISPlay:CBAR:FFT[:POSition]..... | 514 |
| DISPlay:CBAR:SPECTrogram[:POSition]..... | 520 |
| DISPlay:CBAR:ZOOM[:POSition]..... | 452 |
| DISPlay:CLEar[:SCReen]..... | 561 |
| DISPlay:DIALog:CLOSe..... | 563 |
| DISPlay:DIALog:MESSAge..... | 563 |
| DISPlay:DTIME..... | 561 |
| DISPlay:GRID:ANNotation:TRACK..... | 565 |

| | |
|---|-----|
| DISPlay:GRID:ANNOtation[:ENABle]..... | 565 |
| DISPlay:GRID:STYLe..... | 563 |
| DISPlay:INTensity:BACKlight..... | 564 |
| DISPlay:INTensity:GRID..... | 564 |
| DISPlay:INTensity:WAVEform..... | 564 |
| DISPlay:LANGUage..... | 561 |
| DISPlay:MODE..... | 528 |
| DISPlay:PALette..... | 564 |
| DISPlay:PERsistence:CLear..... | 562 |
| DISPlay:PERsistence:INFinite..... | 563 |
| DISPlay:PERsistence:TIME..... | 562 |
| DISPlay:PERsistence:TYPE..... | 562 |
| DISPlay:PERsistence[:STATe]..... | 562 |
| DISPlay:STYLe..... | 565 |
| DISPlay:XY:XSource..... | 528 |
| DISPlay:XY:Y1Source..... | 528 |
| DISPlay:XY:Y2Source..... | 528 |
| DVM<m>:ENABle..... | 529 |
| DVM<m>:RESult[:ACTual]:STATus?..... | 530 |
| DVM<m>:RESult[:ACTual]?..... | 529 |
| DVM<m>:SOURce..... | 529 |
| DVM<m>:TYPE..... | 529 |
| EXPort:ATABle:NAME..... | 487 |
| EXPort:ATABle:SAVE..... | 487 |
| EXPort:MEASurement:STATistics:ALL:NAME..... | 496 |
| EXPort:MEASurement:STATistics:ALL:SAVE..... | 496 |
| EXPort:MEASurement<m>:STATistics:NAME..... | 495 |
| EXPort:MEASurement<m>:STATistics:SAVE..... | 496 |
| EXPort:POWER:NAME..... | 699 |
| EXPort:POWER:NAME..... | 730 |
| EXPort:POWER:SAVE..... | 699 |
| EXPort:POWER:SAVE..... | 730 |
| EXPort:SEARch:NAME..... | 476 |
| EXPort:SEARch:SAVE..... | 476 |
| EXPort:WAVEform:NAME..... | 551 |
| EXPort:WAVEform:SAVE..... | 551 |
| EXPort:WAVEform:SOURce..... | 551 |
| FORMat:BORDER..... | 541 |
| FORMat[:DATA]..... | 539 |
| HCOPY:COLor:SCHEME..... | 553 |
| HCOPY:CWINDOW..... | 552 |
| HCOPY:DATA?..... | 553 |
| HCOPY:FORMat..... | 553 |
| HCOPY:LANGUage..... | 553 |
| HCOPY:SIZE:X?..... | 553 |
| HCOPY:SIZE:Y?..... | 553 |
| HCOPY[:IMMEDIATE]..... | 552 |
| LOGic<p>:CURRent:STATe:MAXimum?..... | 738 |
| LOGic<p>:CURRent:STATe:MINimum?..... | 738 |
| LOGic<p>:DATA:HEADer?..... | 742 |

| | |
|---------------------------------------|-----|
| LOGic<p>:DATA:POINts..... | 743 |
| LOGic<p>:DATA:XINCrement?..... | 549 |
| LOGic<p>:DATA:XORigin?..... | 548 |
| LOGic<p>:DATA:YINCrement?..... | 550 |
| LOGic<p>:DATA:YORigin?..... | 549 |
| LOGic<p>:DATA:YRESolution?..... | 550 |
| LOGic<p>:DATA?..... | 742 |
| LOGic<p>:HISTory:CONTRol:ENABle]..... | 480 |
| LOGic<p>:HISTory:CURRent..... | 480 |
| LOGic<p>:HISTory:PALL..... | 480 |
| LOGic<p>:HISTory:PLAYer:SPEEd..... | 481 |
| LOGic<p>:HISTory:PLAYer:STATe..... | 482 |
| LOGic<p>:HISTory:REPLay..... | 482 |
| LOGic<p>:HISTory:STARt..... | 481 |
| LOGic<p>:HISTory:STOP..... | 481 |
| LOGic<p>:HISTory:TSABsolute:ALL?..... | 485 |
| LOGic<p>:HISTory:TSABsolute?..... | 485 |
| LOGic<p>:HISTory:TSDate:ALL?..... | 486 |
| LOGic<p>:HISTory:TSDate?..... | 485 |
| LOGic<p>:HISTory:TSRelative:ALL?..... | 484 |
| LOGic<p>:HISTory:TSRelative?..... | 484 |
| LOGic<p>:HISTory:TTABLE[:ENABle]..... | 483 |
| LOGic<p>:PROBe[:ENABle]?..... | 737 |
| LOGic<p>:STATe..... | 738 |
| MASK:ACTion:PULSe:EVENT:MODE..... | 509 |
| MASK:ACTion:SCRSave:DESTination..... | 510 |
| MASK:ACTion:SCRSave:EVENT:MODE..... | 509 |
| MASK:ACTion:SOUNd:EVENT:MODE..... | 509 |
| MASK:ACTion:STOP:EVENT:COUNT..... | 510 |
| MASK:ACTion:STOP:EVENT:MODE..... | 509 |
| MASK:ACTion:WFMSave:DESTination..... | 510 |
| MASK:ACTion:WFMSave:EVENT:MODE..... | 509 |
| MASK:ACTion:YOUT:ENABle..... | 511 |
| MASK:CAPTure[:MODE]..... | 512 |
| MASK:CHCopy..... | 508 |
| MASK:COUNT?..... | 511 |
| MASK:DATA:HEADer?..... | 547 |
| MASK:DATA:XINCrement?..... | 549 |
| MASK:DATA:XORigin?..... | 548 |
| MASK:DATA:YINCrement?..... | 550 |
| MASK:DATA:YORigin?..... | 549 |
| MASK:DATA:YRESolution?..... | 550 |
| MASK:DATA?..... | 547 |
| MASK:LOAD..... | 509 |
| MASK:RESet:COUNTer..... | 511 |
| MASK:SAVE..... | 508 |
| MASK:SOURce..... | 507 |
| MASK:STATe..... | 507 |
| MASK:TEST..... | 511 |
| MASK:VCOunt?..... | 511 |

| | |
|--|-----|
| MASK:XWIDth..... | 508 |
| MASK:YPOStion..... | 508 |
| MASK:YSCale..... | 508 |
| MASK:YWIDth..... | 508 |
| MEASurement<m>:ALL[:STATe]..... | 488 |
| MEASurement<m>:AOFF..... | 488 |
| MEASurement<m>:AON..... | 488 |
| MEASurement<m>:AREsult?..... | 488 |
| MEASurement<m>:DELay:SLOPe..... | 492 |
| MEASurement<m>:GATE..... | 498 |
| MEASurement<m>:GATE:ABSolute:STARt..... | 498 |
| MEASurement<m>:GATE:ABSolute:STOP..... | 498 |
| MEASurement<m>:GATE:MODE..... | 498 |
| MEASurement<m>:GATE:RELative:STARt..... | 499 |
| MEASurement<m>:GATE:RELative:STOP..... | 499 |
| MEASurement<m>:MAIN..... | 489 |
| MEASurement<m>:RESult:AVG?..... | 493 |
| MEASurement<m>:RESult:NPEak?..... | 494 |
| MEASurement<m>:RESult:PPEak?..... | 494 |
| MEASurement<m>:RESult:STDDev?..... | 493 |
| MEASurement<m>:RESult:WFMCount?..... | 494 |
| MEASurement<m>:RESult[:ACTual]?..... | 493 |
| MEASurement<m>:SOURce..... | 491 |
| MEASurement<m>:STATistics:RESet..... | 492 |
| MEASurement<m>:STATistics:VALue:ALL?..... | 495 |
| MEASurement<m>:STATistics:VALue<n>?..... | 495 |
| MEASurement<m>:STATistics:WEIGHT?..... | 494 |
| MEASurement<m>:STATistics[:ENABle]..... | 492 |
| MEASurement<m>[:ENABle]..... | 489 |
| MMEMory:CATalog:LENGth?..... | 558 |
| MMEMory:CATalog?..... | 557 |
| MMEMory:CDIRectory..... | 555 |
| MMEMory:COPI..... | 558 |
| MMEMory:DATA..... | 559 |
| MMEMory:DCATalog:LENGth?..... | 557 |
| MMEMory:DCATalog?..... | 556 |
| MMEMory:DELeTe..... | 559 |
| MMEMory:DRIVes?..... | 554 |
| MMEMory:LOAD:STATe..... | 560 |
| MMEMory:MDIRectory..... | 555 |
| MMEMory:MOVE..... | 558 |
| MMEMory:MSIS..... | 555 |
| MMEMory:NAME..... | 552 |
| MMEMory:RDIRectory..... | 556 |
| MMEMory:STORe:STATe..... | 560 |
| PGENerator:FUNCTion..... | 757 |
| PGENerator:MANual:STATe<s>..... | 762 |
| PGENerator:PATtern:ARBitrary:DATA:APPend..... | 760 |
| PGENerator:PATtern:ARBitrary:DATA:APPend:BAND..... | 761 |
| PGENerator:PATtern:ARBitrary:DATA:APPend:BOR..... | 760 |

| | |
|---|-----|
| PGENERator:PATtern:ARBitrary:DATA:APPend:INDEX..... | 761 |
| PGENERator:PATtern:ARBitrary:DATA:LENGth..... | 760 |
| PGENERator:PATtern:ARBitrary:DATA[:SET]..... | 760 |
| PGENERator:PATtern:BURSt:NCYCLE..... | 762 |
| PGENERator:PATtern:BURSt:STATe..... | 762 |
| PGENERator:PATtern:COUNter:DIRectIon..... | 759 |
| PGENERator:PATtern:COUNter:FREQuency..... | 759 |
| PGENERator:PATtern:FREQuency..... | 759 |
| PGENERator:PATtern:ITIME..... | 761 |
| PGENERator:PATtern:LED:BLUE..... | 763 |
| PGENERator:PATtern:LED:GREen..... | 763 |
| PGENERator:PATtern:LED:INTens..... | 763 |
| PGENERator:PATtern:LED:RED..... | 763 |
| PGENERator:PATtern:PERiod..... | 759 |
| PGENERator:PATtern:PWM:DCYCLE..... | 763 |
| PGENERator:PATtern:PWM:DIRectIon..... | 763 |
| PGENERator:PATtern:PWM:ENABle..... | 763 |
| PGENERator:PATtern:SQUarewave:DCYCLE..... | 758 |
| PGENERator:PATtern:SQUarewave:POLarity..... | 758 |
| PGENERator:PATtern:STATe..... | 758 |
| PGENERator:PATtern:STIME..... | 761 |
| PGENERator:PATtern:TRIGger:EXTern:SLOPe..... | 758 |
| PGENERator:PATtern:TRIGger:MODE..... | 760 |
| PGENERator:PATtern:TRIGger:SINGLE..... | 761 |
| POWER:ATYPe..... | 684 |
| POWER:AUToscale..... | 685 |
| POWER:AUToscale:CURREnt..... | 685 |
| POWER:AUToscale:VOLTage..... | 685 |
| POWER:CONSumption:EXECute..... | 688 |
| POWER:CONSumption:REPort:ADD..... | 688 |
| POWER:CONSumption:RESStart..... | 688 |
| POWER:CONSumption:RESult:APParent?..... | 688 |
| POWER:CONSumption:RESult:DURation?..... | 689 |
| POWER:CONSumption:RESult:ENERgy?..... | 689 |
| POWER:CONSumption:RESult:PFACTOR?..... | 689 |
| POWER:CONSumption:RESult:PHASe?..... | 689 |
| POWER:CONSumption:RESult:REACTive?..... | 689 |
| POWER:CONSumption:RESult:REALpower?..... | 690 |
| POWER:DESKew[:EXECute]..... | 686 |
| POWER:DONResistance:EXECute..... | 690 |
| POWER:DONResistance:GATE<n>:START..... | 690 |
| POWER:DONResistance:GATE<n>:STOP..... | 690 |
| POWER:DONResistance:REPort:ADD..... | 690 |
| POWER:DONResistance:RESult:DONResistance?..... | 691 |
| POWER:EFFiciency:EXECute..... | 691 |
| POWER:EFFiciency:REPort:ADD..... | 691 |
| POWER:EFFiciency:RESult:EFFiciency:AVG?..... | 691 |
| POWER:EFFiciency:RESult:EFFiciency:NPEak?..... | 691 |
| POWER:EFFiciency:RESult:EFFiciency:PPEak?..... | 691 |
| POWER:EFFiciency:RESult:EFFiciency:STDDev?..... | 692 |

| | |
|--|-----|
| POWER:EFFiciency:RESult:EFFiciency:WFMCount? | 692 |
| POWER:EFFiciency:RESult:EFFiciency[:ACTual]? | 691 |
| POWER:EFFiciency:RESult:INPut:REALpower:AVG? | 692 |
| POWER:EFFiciency:RESult:INPut:REALpower:NPEak? | 692 |
| POWER:EFFiciency:RESult:INPut:REALpower:PPEak? | 692 |
| POWER:EFFiciency:RESult:INPut:REALpower:STDDev? | 692 |
| POWER:EFFiciency:RESult:INPut:REALpower:WFMCount? | 692 |
| POWER:EFFiciency:RESult:INPut:REALpower[:ACTual]? | 692 |
| POWER:EFFiciency:RESult:OUTPut:REALpower:AVG? | 692 |
| POWER:EFFiciency:RESult:OUTPut:REALpower:NPEak? | 692 |
| POWER:EFFiciency:RESult:OUTPut:REALpower:PPEak? | 692 |
| POWER:EFFiciency:RESult:OUTPut:REALpower:STDDev? | 692 |
| POWER:EFFiciency:RESult:OUTPut:REALpower:WFMCount? | 692 |
| POWER:EFFiciency:RESult:OUTPut:REALpower[:ACTual]? | 692 |
| POWER:ENABle | 685 |
| POWER:HARMonics:AVAlable? | 693 |
| POWER:HARMonics:DOFRrequency | 694 |
| POWER:HARMonics:ENFRrequency | 694 |
| POWER:HARMonics:EXECute | 694 |
| POWER:HARMonics:MEASurement:DURation? | 694 |
| POWER:HARMonics:MEASurement:FREQuency:AVG? | 694 |
| POWER:HARMonics:MEASurement:FREQuency:NPEak? | 694 |
| POWER:HARMonics:MEASurement:FREQuency:PPEak? | 695 |
| POWER:HARMonics:MEASurement:FREQuency:STDDev? | 695 |
| POWER:HARMonics:MEASurement:FREQuency[:ACTual]? | 695 |
| POWER:HARMonics:MEASurement:REALpower[:ACTual]? | 695 |
| POWER:HARMonics:MEASurement:THDistortion:AVG? | 695 |
| POWER:HARMonics:MEASurement:THDistortion:NPEak? | 695 |
| POWER:HARMonics:MEASurement:THDistortion:PPEak? | 696 |
| POWER:HARMonics:MEASurement:THDistortion:STDDev? | 696 |
| POWER:HARMonics:MEASurement:THDistortion[:ACTual]? | 696 |
| POWER:HARMonics:MIFrequency | 696 |
| POWER:HARMonics:REPort:ADD | 696 |
| POWER:HARMonics:RESult<n>:FREQuency? | 696 |
| POWER:HARMonics:RESult<n>:LEVel:LIMit? | 697 |
| POWER:HARMonics:RESult<n>:LEVel[:VALue]? | 697 |
| POWER:HARMonics:RESult<n>:MAXimum? | 697 |
| POWER:HARMonics:RESult<n>:MEAN? | 697 |
| POWER:HARMonics:RESult<n>:MINimum? | 697 |
| POWER:HARMonics:RESult<n>:RESet | 698 |
| POWER:HARMonics:RESult<n>:VALid? | 698 |
| POWER:HARMonics:RESult<n>:VCOunt? | 698 |
| POWER:HARMonics:RESult<n>:WFMCount? | 698 |
| POWER:HARMonics:STANdard | 698 |
| POWER:INRushcurrent:EXECute | 699 |
| POWER:INRushcurrent:GATE<n>:START | 699 |
| POWER:INRushcurrent:GATE<n>:STOP | 699 |
| POWER:INRushcurrent:GCOunt | 700 |
| POWER:INRushcurrent:REPort:ADD | 700 |
| POWER:INRushcurrent:RESult<n>:AREA? | 700 |

| | |
|---|-----|
| POWER:INRushcurrent:RESult<n>:MAXCurrent?..... | 700 |
| POWER:MODulation:EXECute..... | 702 |
| POWER:MODulation:REPort:ADD..... | 702 |
| POWER:MODulation:RESult:LPEak:AVG?..... | 702 |
| POWER:MODulation:RESult:LPEak:NPEak?..... | 702 |
| POWER:MODulation:RESult:LPEak:PPEak?..... | 702 |
| POWER:MODulation:RESult:LPEak:STDDev?..... | 702 |
| POWER:MODulation:RESult:LPEak:WFMCount?..... | 702 |
| POWER:MODulation:RESult:LPEak[ACTual]?..... | 702 |
| POWER:MODulation:RESult:MEAN:AVG?..... | 702 |
| POWER:MODulation:RESult:MEAN:NPEak?..... | 702 |
| POWER:MODulation:RESult:MEAN:PPEak?..... | 703 |
| POWER:MODulation:RESult:MEAN:STDDev?..... | 703 |
| POWER:MODulation:RESult:MEAN:WFMCount?..... | 703 |
| POWER:MODulation:RESult:MEAN[ACTual]?..... | 702 |
| POWER:MODulation:RESult:RMS:AVG?..... | 703 |
| POWER:MODulation:RESult:RMS:NPEak?..... | 703 |
| POWER:MODulation:RESult:RMS:PPEak?..... | 703 |
| POWER:MODulation:RESult:RMS:STDDev?..... | 703 |
| POWER:MODulation:RESult:RMS:WFMCount?..... | 703 |
| POWER:MODulation:RESult:RMS[ACTual]?..... | 703 |
| POWER:MODulation:RESult:STDDev:AVG?..... | 703 |
| POWER:MODulation:RESult:STDDev:NPEak?..... | 703 |
| POWER:MODulation:RESult:STDDev:PPEak?..... | 703 |
| POWER:MODulation:RESult:STDDev:STDDev?..... | 703 |
| POWER:MODulation:RESult:STDDev:WFMCount?..... | 703 |
| POWER:MODulation:RESult:STDDev[ACTual]?..... | 703 |
| POWER:MODulation:RESult:UPEak:AVG?..... | 704 |
| POWER:MODulation:RESult:UPEak:NPEak?..... | 704 |
| POWER:MODulation:RESult:UPEak:PPEak?..... | 704 |
| POWER:MODulation:RESult:UPEak:STDDev?..... | 704 |
| POWER:MODulation:RESult:UPEak[ACTual]?..... | 704 |
| POWER:MODulation:RESult:UPEakWFMCount?..... | 704 |
| POWER:MODulation:THReshold:HYSteresis..... | 702 |
| POWER:MODulation:THReshold:LOWer..... | 702 |
| POWER:MODulation:THReshold[UPPer]..... | 702 |
| POWER:MODulation:TYPE..... | 701 |
| POWER:ONOff:EXECute..... | 704 |
| POWER:ONOff:MEASurement..... | 704 |
| POWER:ONOff:REPort:ADD..... | 705 |
| POWER:ONOff:RESult<n>:TIME?..... | 705 |
| POWER:QUALity:EXECute..... | 706 |
| POWER:QUALity:REPort:ADD..... | 707 |
| POWER:QUALity:RESult:CURREnt:CREStfactor:AVG?..... | 707 |
| POWER:QUALity:RESult:CURREnt:CREStfactor:NPEak?..... | 707 |
| POWER:QUALity:RESult:CURREnt:CREStfactor:PPEak?..... | 707 |
| POWER:QUALity:RESult:CURREnt:CREStfactor:STDDev?..... | 708 |
| POWER:QUALity:RESult:CURREnt:CREStfactor:WFMCount?..... | 708 |
| POWER:QUALity:RESult:CURREnt:CREStfactor[ACTual]?..... | 708 |
| POWER:QUALity:RESult:CURREnt:FREQuency:AVG?..... | 707 |

| | |
|---|-----|
| POWER:QUALity:RESult:CURRent:FREQuency:NPEak?..... | 707 |
| POWER:QUALity:RESult:CURRent:FREQuency:PPEak?..... | 707 |
| POWER:QUALity:RESult:CURRent:FREQuency:STDDev?..... | 708 |
| POWER:QUALity:RESult:CURRent:FREQuency:WFMCount?..... | 708 |
| POWER:QUALity:RESult:CURRent:FREQuency[:ACTual]?..... | 708 |
| POWER:QUALity:RESult:CURRent:RMS:AVG?..... | 707 |
| POWER:QUALity:RESult:CURRent:RMS:NPEak?..... | 707 |
| POWER:QUALity:RESult:CURRent:RMS:PPEak?..... | 707 |
| POWER:QUALity:RESult:CURRent:RMS:STDDev?..... | 708 |
| POWER:QUALity:RESult:CURRent:RMS:WFMCount?..... | 708 |
| POWER:QUALity:RESult:CURRent:RMS[:ACTual]?..... | 709 |
| POWER:QUALity:RESult:POWer:APParent:AVG?..... | 707 |
| POWER:QUALity:RESult:POWer:APParent:NPEak?..... | 707 |
| POWER:QUALity:RESult:POWer:APParent:PPEak?..... | 707 |
| POWER:QUALity:RESult:POWer:APParent:STDDev?..... | 708 |
| POWER:QUALity:RESult:POWer:APParent:WFMCount?..... | 708 |
| POWER:QUALity:RESult:POWer:APParent[:ACTual]?..... | 709 |
| POWER:QUALity:RESult:POWer:PFACtor:AVG?..... | 707 |
| POWER:QUALity:RESult:POWer:PFACtor:NPEak?..... | 707 |
| POWER:QUALity:RESult:POWer:PFACtor:PPEak?..... | 707 |
| POWER:QUALity:RESult:POWer:PFACtor:STDDev?..... | 708 |
| POWER:QUALity:RESult:POWer:PFACtor:WFMCount?..... | 708 |
| POWER:QUALity:RESult:POWer:PFACtor[:ACTual]?..... | 709 |
| POWER:QUALity:RESult:POWer:PHASe:AVG?..... | 707 |
| POWER:QUALity:RESult:POWer:PHASe:NPEak?..... | 707 |
| POWER:QUALity:RESult:POWer:PHASe:PPEak?..... | 707 |
| POWER:QUALity:RESult:POWer:PHASe:STDDev?..... | 708 |
| POWER:QUALity:RESult:POWer:PHASe:WFMCount?..... | 708 |
| POWER:QUALity:RESult:POWer:PHASe[:ACTual]?..... | 709 |
| POWER:QUALity:RESult:POWer:REACTive:AVG?..... | 707 |
| POWER:QUALity:RESult:POWer:REACTive:NPEak?..... | 707 |
| POWER:QUALity:RESult:POWer:REACTive:PPEak?..... | 707 |
| POWER:QUALity:RESult:POWer:REACTive:STDDev?..... | 708 |
| POWER:QUALity:RESult:POWer:REACTive:WFMCount?..... | 708 |
| POWER:QUALity:RESult:POWer:REACTive[:ACTual]?..... | 709 |
| POWER:QUALity:RESult:POWer:REALpower:AVG?..... | 707 |
| POWER:QUALity:RESult:POWer:REALpower:NPEak?..... | 707 |
| POWER:QUALity:RESult:POWer:REALpower:PPEak?..... | 708 |
| POWER:QUALity:RESult:POWer:REALpower:STDDev?..... | 708 |
| POWER:QUALity:RESult:POWer:REALpower:WFMCount?..... | 708 |
| POWER:QUALity:RESult:POWer:REALpower[:ACTual]?..... | 709 |
| POWER:QUALity:RESult:VOLTagE:CREStfactor:AVG?..... | 707 |
| POWER:QUALity:RESult:VOLTagE:CREStfactor:NPEak?..... | 707 |
| POWER:QUALity:RESult:VOLTagE:CREStfactor:PPEak?..... | 708 |
| POWER:QUALity:RESult:VOLTagE:CREStfactor:STDDev?..... | 708 |
| POWER:QUALity:RESult:VOLTagE:CREStfactor:WFMCount?..... | 708 |
| POWER:QUALity:RESult:VOLTagE:CREStfactor[:ACTual]?..... | 709 |
| POWER:QUALity:RESult:VOLTagE:FREQuency:AVG?..... | 707 |
| POWER:QUALity:RESult:VOLTagE:FREQuency:NPEak?..... | 707 |
| POWER:QUALity:RESult:VOLTagE:FREQuency:PPEak?..... | 708 |

| | |
|---|-----|
| POWer:QUALity:RESult:VOLTage:FREQuency:STDDev?..... | 708 |
| POWer:QUALity:RESult:VOLTage:FREQuency:WFMCount?..... | 708 |
| POWer:QUALity:RESult:VOLTage:FREQuency[:ACTual]?..... | 709 |
| POWer:QUALity:RESult:VOLTage:RMS:AVG?..... | 707 |
| POWer:QUALity:RESult:VOLTage:RMS:NPEak?..... | 707 |
| POWer:QUALity:RESult:VOLTage:RMS:PPEak?..... | 708 |
| POWer:QUALity:RESult:VOLTage:RMS:STDDev?..... | 708 |
| POWer:QUALity:RESult:VOLTage:RMS:WFMCount?..... | 708 |
| POWer:QUALity:RESult:VOLTage:RMS[:ACTual]?..... | 709 |
| POWer:REPort:ADD..... | 687 |
| POWer:REPort:DESCRiption..... | 687 |
| POWer:REPort:DUT..... | 687 |
| POWer:REPort:OUTPut..... | 687 |
| POWer:REPort:SITE..... | 687 |
| POWer:REPort:TEMPerature..... | 687 |
| POWer:REPort:USER..... | 688 |
| POWer:RESult:TABLE..... | 685 |
| POWer:RIPPlE:EXECute..... | 710 |
| POWer:RIPPlE:REPort:ADD..... | 710 |
| POWer:RIPPlE:RESult:FREQuency:AVG?..... | 710 |
| POWer:RIPPlE:RESult:FREQuency:AVG?..... | 716 |
| POWer:RIPPlE:RESult:FREQuency:NPEak?..... | 710 |
| POWer:RIPPlE:RESult:FREQuency:NPEak?..... | 716 |
| POWer:RIPPlE:RESult:FREQuency:PPEak?..... | 710 |
| POWer:RIPPlE:RESult:FREQuency:PPEak?..... | 716 |
| POWer:RIPPlE:RESult:FREQuency:STDDev?..... | 710 |
| POWer:RIPPlE:RESult:FREQuency:STDDev?..... | 716 |
| POWer:RIPPlE:RESult:FREQuency:WFMCount?..... | 710 |
| POWer:RIPPlE:RESult:FREQuency:WFMCount?..... | 716 |
| POWer:RIPPlE:RESult:FREQuency[:ACTual]?..... | 710 |
| POWer:RIPPlE:RESult:FREQuency[:ACTual]?..... | 716 |
| POWer:RIPPlE:RESult:LPEak:AVG?..... | 711 |
| POWer:RIPPlE:RESult:LPEak:NPEak?..... | 711 |
| POWer:RIPPlE:RESult:LPEak:PPEak?..... | 711 |
| POWer:RIPPlE:RESult:LPEak:STDDev?..... | 711 |
| POWer:RIPPlE:RESult:LPEak:WFMCount?..... | 711 |
| POWer:RIPPlE:RESult:LPEak[:ACTual]?..... | 711 |
| POWer:RIPPlE:RESult:MEAN:AVG?..... | 711 |
| POWer:RIPPlE:RESult:MEAN:AVG?..... | 717 |
| POWer:RIPPlE:RESult:MEAN:NPEak?..... | 711 |
| POWer:RIPPlE:RESult:MEAN:NPEak?..... | 717 |
| POWer:RIPPlE:RESult:MEAN:PPEak?..... | 711 |
| POWer:RIPPlE:RESult:MEAN:PPEak?..... | 717 |
| POWer:RIPPlE:RESult:MEAN:STDDev?..... | 711 |
| POWer:RIPPlE:RESult:MEAN:STDDev?..... | 717 |
| POWer:RIPPlE:RESult:MEAN:WFMCount?..... | 711 |
| POWer:RIPPlE:RESult:MEAN:WFMCount?..... | 717 |
| POWer:RIPPlE:RESult:MEAN[:ACTual]?..... | 711 |
| POWer:RIPPlE:RESult:MEAN[:ACTual]?..... | 717 |
| POWer:RIPPlE:RESult:NDCYcle:AVG?..... | 712 |

| | |
|--|-----|
| POWer:RIPPlE:RESult:NDCYcle:AVG?..... | 717 |
| POWer:RIPPlE:RESult:NDCYcle:NPEak?..... | 712 |
| POWer:RIPPlE:RESult:NDCYcle:NPEak?..... | 717 |
| POWer:RIPPlE:RESult:NDCYcle:PPEak?..... | 712 |
| POWer:RIPPlE:RESult:NDCYcle:PPEak?..... | 717 |
| POWer:RIPPlE:RESult:NDCYcle:STDDev?..... | 712 |
| POWer:RIPPlE:RESult:NDCYcle:STDDev?..... | 717 |
| POWer:RIPPlE:RESult:NDCYcle:WFMCount?..... | 712 |
| POWer:RIPPlE:RESult:NDCYcle:WFMCount?..... | 717 |
| POWer:RIPPlE:RESult:NDCYcle[:ACTual]?..... | 712 |
| POWer:RIPPlE:RESult:NDCYcle[:ACTual]?..... | 717 |
| POWer:RIPPlE:RESult:PDCYcle:AVG?..... | 712 |
| POWer:RIPPlE:RESult:PDCYcle:AVG?..... | 718 |
| POWer:RIPPlE:RESult:PDCYcle:NPEak?..... | 712 |
| POWer:RIPPlE:RESult:PDCYcle:NPEak?..... | 718 |
| POWer:RIPPlE:RESult:PDCYcle:PPEak?..... | 712 |
| POWer:RIPPlE:RESult:PDCYcle:PPEak?..... | 718 |
| POWer:RIPPlE:RESult:PDCYcle:STDDev?..... | 712 |
| POWer:RIPPlE:RESult:PDCYcle:STDDev?..... | 718 |
| POWer:RIPPlE:RESult:PDCYcle:WFMCount?..... | 712 |
| POWer:RIPPlE:RESult:PDCYcle:WFMCount?..... | 718 |
| POWer:RIPPlE:RESult:PDCYcle[:ACTual]?..... | 712 |
| POWer:RIPPlE:RESult:PDCYcle[:ACTual]?..... | 718 |
| POWer:RIPPlE:RESult:PEAK:AVG?..... | 712 |
| POWer:RIPPlE:RESult:PEAK:AVG?..... | 718 |
| POWer:RIPPlE:RESult:PEAK:NPEak?..... | 712 |
| POWer:RIPPlE:RESult:PEAK:NPEak?..... | 718 |
| POWer:RIPPlE:RESult:PEAK:PPEak?..... | 712 |
| POWer:RIPPlE:RESult:PEAK:PPEak?..... | 718 |
| POWer:RIPPlE:RESult:PEAK:STDDev?..... | 713 |
| POWer:RIPPlE:RESult:PEAK:STDDev?..... | 718 |
| POWer:RIPPlE:RESult:PEAK:WFMCount?..... | 713 |
| POWer:RIPPlE:RESult:PEAK:WFMCount?..... | 718 |
| POWer:RIPPlE:RESult:PEAK[:ACTual]?..... | 712 |
| POWer:RIPPlE:RESult:PEAK[:ACTual]?..... | 718 |
| POWer:RIPPlE:RESult:PERiod:AVG?..... | 713 |
| POWer:RIPPlE:RESult:PERiod:AVG?..... | 718 |
| POWer:RIPPlE:RESult:PERiod:NPEak?..... | 713 |
| POWer:RIPPlE:RESult:PERiod:NPEak?..... | 719 |
| POWer:RIPPlE:RESult:PERiod:PPEak?..... | 713 |
| POWer:RIPPlE:RESult:PERiod:PPEak?..... | 719 |
| POWer:RIPPlE:RESult:PERiod:STDDev?..... | 713 |
| POWer:RIPPlE:RESult:PERiod:STDDev?..... | 719 |
| POWer:RIPPlE:RESult:PERiod:WFMCount?..... | 713 |
| POWer:RIPPlE:RESult:PERiod:WFMCount?..... | 719 |
| POWer:RIPPlE:RESult:PERiod[:ACTual]?..... | 713 |
| POWer:RIPPlE:RESult:PERiod[:ACTual]?..... | 718 |
| POWer:RIPPlE:RESult:STDDev:AVG?..... | 713 |
| POWer:RIPPlE:RESult:STDDev:AVG?..... | 719 |
| POWer:RIPPlE:RESult:STDDev:NPEak?..... | 713 |

| | |
|--|-----|
| POWer:RIPPlE:RESult:STDDev:NPEak? | 719 |
| POWer:RIPPlE:RESult:STDDev:PPEak? | 713 |
| POWer:RIPPlE:RESult:STDDev:PPEak? | 719 |
| POWer:RIPPlE:RESult:STDDev:STDDev? | 713 |
| POWer:RIPPlE:RESult:STDDev:STDDev? | 719 |
| POWer:RIPPlE:RESult:STDDev:WFMCount? | 713 |
| POWer:RIPPlE:RESult:STDDev:WFMCount? | 719 |
| POWer:RIPPlE:RESult:STDDev[:ACTual]? | 713 |
| POWer:RIPPlE:RESult:STDDev[:ACTual]? | 719 |
| POWer:RIPPlE:RESult:UPEak:AVG? | 714 |
| POWer:RIPPlE:RESult:UPEak:NPEak? | 714 |
| POWer:RIPPlE:RESult:UPEak:PPEak? | 714 |
| POWer:RIPPlE:RESult:UPEak:STDDev? | 714 |
| POWer:RIPPlE:RESult:UPEak:WFMCount? | 714 |
| POWer:RIPPlE:RESult:UPEak[:ACTual]? | 714 |
| POWer:SLEWrate:DSAMple | 715 |
| POWer:SLEWrate:DTIME | 716 |
| POWer:SLEWrate:EXECute | 716 |
| POWer:SLEWrate:REPort:ADD | 716 |
| POWer:SLEWrate:RESult:LPEak:AVG? | 716 |
| POWer:SLEWrate:RESult:LPEak:NPEak? | 716 |
| POWer:SLEWrate:RESult:LPEak:PPEak? | 716 |
| POWer:SLEWrate:RESult:LPEak:STDDev? | 716 |
| POWer:SLEWrate:RESult:LPEak:WFMCount? | 716 |
| POWer:SLEWrate:RESult:LPEak[:ACTual]? | 716 |
| POWer:SLEWrate:RESult:UPEak:AVG? | 719 |
| POWer:SLEWrate:RESult:UPEak:NPEak? | 719 |
| POWer:SLEWrate:RESult:UPEak:PPEak? | 719 |
| POWer:SLEWrate:RESult:UPEak:STDDev? | 719 |
| POWer:SLEWrate:RESult:UPEak:WFMCount? | 719 |
| POWer:SLEWrate:RESult:UPEak[:ACTual]? | 719 |
| POWer:SOA:EXECute | 721 |
| POWer:SOA:LINear:ADD | 721 |
| POWer:SOA:LINear:COUNT? | 721 |
| POWer:SOA:LINear:INSert | 721 |
| POWer:SOA:LINear:POINT<m>:CURRent | 722 |
| POWer:SOA:LINear:POINT<m>:CURRent:MAXimum | 722 |
| POWer:SOA:LINear:POINT<m>:CURRent:MINimum | 722 |
| POWer:SOA:LINear:POINT<m>:VOLTage | 722 |
| POWer:SOA:LINear:REMove | 723 |
| POWer:SOA:LOGarithmic:ADD | 721 |
| POWer:SOA:LOGarithmic:COUNT? | 721 |
| POWer:SOA:LOGarithmic:INSert | 721 |
| POWer:SOA:LOGarithmic:POINT<m>:CURRent | 722 |
| POWer:SOA:LOGarithmic:POINT<m>:CURRent:MAXimum | 722 |
| POWer:SOA:LOGarithmic:POINT<m>:CURRent:MINimum | 722 |
| POWer:SOA:LOGarithmic:POINT<m>:VOLTage | 722 |
| POWer:SOA:LOGarithmic:REMove | 723 |
| POWer:SOA:REPort:ADD | 728 |
| POWer:SOA:REStart | 728 |

| | |
|--|-----|
| POWer:SOA:RESult:ACQuisition:FAILed?..... | 723 |
| POWer:SOA:RESult:ACQuisition:FRATe?..... | 723 |
| POWer:SOA:RESult:ACQuisition:PASSed?..... | 723 |
| POWer:SOA:RESult:ACQuisition:POINts?..... | 723 |
| POWer:SOA:RESult:ACQuisition:STATe?..... | 723 |
| POWer:SOA:RESult:ACQuisition:TOLerance..... | 724 |
| POWer:SOA:RESult:ACQuisition:VCOunt?..... | 724 |
| POWer:SOA:RESult:ACQuisition:VIOLation<n>:CURRent?..... | 724 |
| POWer:SOA:RESult:ACQuisition:VIOLation<n>?..... | 724 |
| POWer:SOA:RESult:TOTal:COUnT?..... | 724 |
| POWer:SOA:RESult:TOTal:FAILed?..... | 725 |
| POWer:SOA:RESult:TOTal:FRATe?..... | 725 |
| POWer:SOA:RESult:TOTal:PASSed?..... | 725 |
| POWer:SOA:RESult:TOTal:SAMPle:COUnT?..... | 725 |
| POWer:SOA:RESult:TOTal:SAMPle:FAILed?..... | 725 |
| POWer:SOA:RESult:TOTal:SAMPle:PASSed?..... | 725 |
| POWer:SOA:RESult:TOTal:STATe?..... | 726 |
| POWer:SOA:RESult:TOTal:TOLerance..... | 726 |
| POWer:SOA:RESult:TOTal:VCOunt?..... | 726 |
| POWer:SOA:RESult:TOTal:VIOLation<n>:CURRent:DATA:HEADer?..... | 727 |
| POWer:SOA:RESult:TOTal:VIOLation<n>:CURRent:DATA:XINCrement?..... | 727 |
| POWer:SOA:RESult:TOTal:VIOLation<n>:CURRent:DATA:XORigin?..... | 727 |
| POWer:SOA:RESult:TOTal:VIOLation<n>:CURRent:DATA:YINCrement?..... | 727 |
| POWer:SOA:RESult:TOTal:VIOLation<n>:CURRent:DATA:YORigin?..... | 728 |
| POWer:SOA:RESult:TOTal:VIOLation<n>:CURRent:DATA:YRESolution?..... | 728 |
| POWer:SOA:RESult:TOTal:VIOLation<n>:CURRent:DATA?..... | 727 |
| POWer:SOA:RESult:TOTal:VIOLation<n>:CURRent?..... | 726 |
| POWer:SOA:RESult:TOTal:VIOLation<n>:VOLTage:DATA:HEADer?..... | 727 |
| POWer:SOA:RESult:TOTal:VIOLation<n>:VOLTage:DATA:XINCrement?..... | 727 |
| POWer:SOA:RESult:TOTal:VIOLation<n>:VOLTage:DATA:XORigin?..... | 727 |
| POWer:SOA:RESult:TOTal:VIOLation<n>:VOLTage:DATA:YINCrement?..... | 727 |
| POWer:SOA:RESult:TOTal:VIOLation<n>:VOLTage:DATA:YORigin?..... | 728 |
| POWer:SOA:RESult:TOTal:VIOLation<n>:VOLTage:DATA:YRESolution?..... | 728 |
| POWer:SOA:RESult:TOTal:VIOLation<n>:VOLTage:DATA?..... | 727 |
| POWer:SOA:RESult:TOTal:VIOLation<n>:VOLTage?..... | 726 |
| POWer:SOA:RESult:TOTal:VIOLation<n>?..... | 726 |
| POWer:SOA:SCALe..... | 728 |
| POWer:SOA:SCALe:DISPlay..... | 728 |
| POWer:SOA:SCALe:MASK..... | 728 |
| POWer:SOURce:CURRent<n>..... | 685 |
| POWer:SOURce:VOLTage<n>..... | 686 |
| POWer:SPECTrum:EXECute..... | 728 |
| POWer:SPECTrum:FREQUency..... | 728 |
| POWer:SPECTrum:REPort:ADD..... | 729 |
| POWer:SPECTrum:RESult<n>:FREQUency?..... | 729 |
| POWer:SPECTrum:RESult<n>:LEVel[:VALue]?..... | 729 |
| POWer:SPECTrum:RESult<n>:MAXimum?..... | 729 |
| POWer:SPECTrum:RESult<n>:MEAN?..... | 729 |
| POWer:SPECTrum:RESult<n>:MINimum?..... | 730 |
| POWer:SPECTrum:RESult<n>:RESet..... | 730 |

| | |
|---|-----|
| POWer:SPEctrum:RESult<n>:WFMCount?..... | 730 |
| POWer:STATistics:RESet..... | 686 |
| POWer:STATistics:VISible..... | 686 |
| POWer:SWITching:EXECute..... | 731 |
| POWer:SWITching:GATE:CONDUction:STARt..... | 731 |
| POWer:SWITching:GATE:CONDUction:STOP..... | 731 |
| POWer:SWITching:GATE:NCONduction:STARt..... | 732 |
| POWer:SWITching:GATE:NCONduction:STOP..... | 732 |
| POWer:SWITching:GATE:SWAVE..... | 732 |
| POWer:SWITching:GATE:TOFF:STARt..... | 732 |
| POWer:SWITching:GATE:TOFF:STOP..... | 732 |
| POWer:SWITching:GATE:TON:STARt..... | 732 |
| POWer:SWITching:GATE:TON:STOP..... | 732 |
| POWer:SWITching:REPort:ADD..... | 733 |
| POWer:SWITching:RESult:CONDUction:ENERgy?..... | 733 |
| POWer:SWITching:RESult:CONDUction:POWer?..... | 733 |
| POWer:SWITching:RESult:NCONduction:ENERgy?..... | 733 |
| POWer:SWITching:RESult:NCONduction:POWer?..... | 733 |
| POWer:SWITching:RESult:TOFF:ENERgy?..... | 733 |
| POWer:SWITching:RESult:TOFF:POWer?..... | 734 |
| POWer:SWITching:RESult:TON:ENERgy?..... | 734 |
| POWer:SWITching:RESult:TON:POWer?..... | 734 |
| POWer:SWITching:RESult:TOTal:ENERgy?..... | 734 |
| POWer:SWITching:RESult:TOTal:POWer?..... | 734 |
| POWer:SWITching:TYPE..... | 734 |
| POWer:TRANSient:EXECute..... | 735 |
| POWer:TRANSient:REPort:ADD..... | 735 |
| POWer:TRANSient:RESult:DELay?..... | 735 |
| POWer:TRANSient:RESult:OVERshoot?..... | 735 |
| POWer:TRANSient:RESult:PEAK:TIME?..... | 735 |
| POWer:TRANSient:RESult:PEAK:VALue?..... | 736 |
| POWer:TRANSient:RESult:RTIME?..... | 736 |
| POWer:TRANSient:RESult:SETTLingtime?..... | 736 |
| POWer:TRANSient:SIGHigh..... | 736 |
| POWer:TRANSient:SIGLow..... | 736 |
| POWer:TRANSient:STARt..... | 736 |
| POWer:TRANSient:STOP..... | 737 |
| POWer:ZOFFset[:EXECute]..... | 686 |
| PROBe<m>:ID:BUILd?..... | 425 |
| PROBe<m>:ID:PARTnumber?..... | 426 |
| PROBe<m>:ID:PRDate?..... | 426 |
| PROBe<m>:ID:SRNumber?..... | 426 |
| PROBe<m>:ID:SWVersion?..... | 426 |
| PROBe<m>:SETup:ATTenuation:MANual..... | 423 |
| PROBe<m>:SETup:ATTenuation:UNIT..... | 423 |
| PROBe<m>:SETup:ATTenuation[:AUTO]?..... | 427 |
| PROBe<m>:SETup:BANDwidth?..... | 427 |
| PROBe<m>:SETup:CAPacitance?..... | 428 |
| PROBe<m>:SETup:DCOFFset?..... | 425 |
| PROBe<m>:SETup:DEGAuss..... | 429 |

| | |
|--|-----|
| PROBe<m>:SETup:GAIN:MANual..... | 424 |
| PROBe<m>:SETup:GAIN:UNIT..... | 423 |
| PROBe<m>:SETup:GAIN[:AUTO]?..... | 428 |
| PROBe<m>:SETup:IMPedance?..... | 428 |
| PROBe<m>:SETup:MODE..... | 425 |
| PROBe<m>:SETup:NAME?..... | 427 |
| PROBe<m>:SETup:OFFSwitch..... | 424 |
| PROBe<m>:SETup:TYPE?..... | 427 |
| REFCurve<m>:DATA:HEADer?..... | 546 |
| REFCurve<m>:DATA:XINCrement?..... | 549 |
| REFCurve<m>:DATA:XORigin?..... | 548 |
| REFCurve<m>:DATA:YINCrement?..... | 550 |
| REFCurve<m>:DATA:YORigin?..... | 549 |
| REFCurve<m>:DATA:YRESolution?..... | 550 |
| REFCurve<m>:DATA?..... | 546 |
| REFCurve<m>:HORizontal:POSition..... | 459 |
| REFCurve<m>:HORizontal:SCALe..... | 459 |
| REFCurve<m>:LABel..... | 460 |
| REFCurve<m>:LOAD..... | 458 |
| REFCurve<m>:LOAD:STATe..... | 459 |
| REFCurve<m>:SAVE..... | 458 |
| REFCurve<m>:SOURce..... | 457 |
| REFCurve<m>:SOURce:CATalog?..... | 457 |
| REFCurve<m>:STATe..... | 458 |
| REFCurve<m>:UPDate..... | 458 |
| REFCurve<m>:VERTical:POSition..... | 459 |
| REFCurve<m>:VERTical:SCALe..... | 460 |
| REFCurve<m>:WCOLor..... | 460 |
| REFLevel:RELative:LOWer..... | 500 |
| REFLevel:RELative:MIDDLE..... | 500 |
| REFLevel:RELative:MODE..... | 499 |
| REFLevel:RELative:UPPer..... | 500 |
| RUN..... | 415 |
| RUNContinous..... | 415 |
| RUNSingle..... | 415 |
| SEARch:CONDition..... | 461 |
| SEARch:MEASure:LEVel:PEAK:MAGNitude..... | 465 |
| SEARch:MEASure:PEAK:POLarity..... | 465 |
| SEARch:PROTocol:ARINc:CONDition..... | 680 |
| SEARch:PROTocol:ARINc:DATA:CONDition..... | 681 |
| SEARch:PROTocol:ARINc:DATA:MAXimum..... | 681 |
| SEARch:PROTocol:ARINc:DATA:MINimum..... | 682 |
| SEARch:PROTocol:ARINc:DATA:OFFSet..... | 682 |
| SEARch:PROTocol:ARINc:DATA:SIZE..... | 682 |
| SEARch:PROTocol:ARINc:ERRor..... | 682 |
| SEARch:PROTocol:ARINc:FORMat..... | 682 |
| SEARch:PROTocol:ARINc:LABel:CONDition..... | 683 |
| SEARch:PROTocol:ARINc:LABel:MAXimum..... | 683 |
| SEARch:PROTocol:ARINc:LABel:MINimum..... | 683 |
| SEARch:PROTocol:ARINc:SDI..... | 683 |

| | |
|---|-----|
| SEARch:PROTocol:ARINc:SSM..... | 683 |
| SEARch:PROTocol:ARINc:WORD[:TYPE]..... | 684 |
| SEARch:PROTocol:CAN:ACKerror..... | 621 |
| SEARch:PROTocol:CAN:BITSterror..... | 622 |
| SEARch:PROTocol:CAN:CONDition..... | 620 |
| SEARch:PROTocol:CAN:CRCerror..... | 622 |
| SEARch:PROTocol:CAN:DATA..... | 624 |
| SEARch:PROTocol:CAN:DCONDition..... | 623 |
| SEARch:PROTocol:CAN:DLENgth..... | 623 |
| SEARch:PROTocol:CAN:FORMerror..... | 622 |
| SEARch:PROTocol:CAN:FRAMe..... | 621 |
| SEARch:PROTocol:CAN:FTYPE..... | 622 |
| SEARch:PROTocol:CAN:ICONDition..... | 623 |
| SEARch:PROTocol:CAN:IDENtifier..... | 623 |
| SEARch:PROTocol:CAN:ITYPE..... | 622 |
| SEARch:PROTocol:LIN:CHKSError..... | 635 |
| SEARch:PROTocol:LIN:CONDition..... | 634 |
| SEARch:PROTocol:LIN:DATA..... | 636 |
| SEARch:PROTocol:LIN:DCONDition..... | 636 |
| SEARch:PROTocol:LIN:DLENgth..... | 636 |
| SEARch:PROTocol:LIN:FRAMe..... | 634 |
| SEARch:PROTocol:LIN:ICONDition..... | 635 |
| SEARch:PROTocol:LIN:IDENtifier..... | 636 |
| SEARch:PROTocol:LIN:IPERror..... | 635 |
| SEARch:PROTocol:LIN:SYERror..... | 635 |
| SEARch:PROTocol:MILStd:CONDition..... | 666 |
| SEARch:PROTocol:MILStd:DATA:CONDition..... | 667 |
| SEARch:PROTocol:MILStd:DATA:MAXimum..... | 667 |
| SEARch:PROTocol:MILStd:DATA:MINimum..... | 667 |
| SEARch:PROTocol:MILStd:DATA:OFFSet..... | 667 |
| SEARch:PROTocol:MILStd:DATA:WORDs..... | 667 |
| SEARch:PROTocol:MILStd:ERRor..... | 667 |
| SEARch:PROTocol:MILStd:MCODE..... | 668 |
| SEARch:PROTocol:MILStd:RTADdress:CONDition..... | 668 |
| SEARch:PROTocol:MILStd:RTADdress:MAXimum..... | 668 |
| SEARch:PROTocol:MILStd:RTADdress:MINimum..... | 668 |
| SEARch:PROTocol:MILStd:SADdress:CONDition..... | 668 |
| SEARch:PROTocol:MILStd:SADdress:MAXimum..... | 668 |
| SEARch:PROTocol:MILStd:SADdress:MCADdress..... | 669 |
| SEARch:PROTocol:MILStd:SADdress:MINimum..... | 669 |
| SEARch:PROTocol:MILStd:STATus:BCReceivEd..... | 669 |
| SEARch:PROTocol:MILStd:STATus:BUSY..... | 669 |
| SEARch:PROTocol:MILStd:STATus:DBCaccept..... | 669 |
| SEARch:PROTocol:MILStd:STATus:INSTrument..... | 669 |
| SEARch:PROTocol:MILStd:STATus:MERRor..... | 670 |
| SEARch:PROTocol:MILStd:STATus:SREQuest..... | 670 |
| SEARch:PROTocol:MILStd:STATus:SUBSystem..... | 670 |
| SEARch:PROTocol:MILStd:STATus:TERMinAl..... | 670 |
| SEARch:PROTocol:MILStd:TRMode..... | 670 |
| SEARch:PROTocol:MILStd:TTYPe..... | 670 |

| | |
|--|-----|
| SEARch:PROTocol:MILStd:WCOunt:CONDition..... | 671 |
| SEARch:PROTocol:MILStd:WCOunt:MAXimum..... | 671 |
| SEARch:PROTocol:MILStd:WCOunt:MINimum..... | 671 |
| SEARch:PROTocol:MILStd:WStart..... | 671 |
| SEARch:RCOunt?..... | 476 |
| SEARch:RESDiagram:SHOW..... | 474 |
| SEARch:RESult:ALL?..... | 475 |
| SEARch:RESult:BCOunt?..... | 474 |
| SEARch:RESult<n>?..... | 475 |
| SEARch:SOURce..... | 462 |
| SEARch:STATe..... | 461 |
| SEARch:TRIGger:DATatoclock:CEdGe..... | 469 |
| SEARch:TRIGger:DATatoclock:CLEVel..... | 469 |
| SEARch:TRIGger:DATatoclock:CLEVel:DELTA..... | 469 |
| SEARch:TRIGger:DATatoclock:CSource..... | 468 |
| SEARch:TRIGger:DATatoclock:DLEVel..... | 469 |
| SEARch:TRIGger:DATatoclock:DLEVel:DELTA..... | 469 |
| SEARch:TRIGger:DATatoclock:HTIME..... | 469 |
| SEARch:TRIGger:DATatoclock:STIME..... | 470 |
| SEARch:TRIGger:EDGE:LEVel..... | 463 |
| SEARch:TRIGger:EDGE:LEVel:DELTA..... | 463 |
| SEARch:TRIGger:EDGE:SLOPe..... | 463 |
| SEARch:TRIGger:LEVel:RISetime:LOWer..... | 465 |
| SEARch:TRIGger:LEVel:RISetime:UPPer..... | 466 |
| SEARch:TRIGger:LEVel:RUNT:LOWer..... | 467 |
| SEARch:TRIGger:LEVel:RUNT:UPPer..... | 467 |
| SEARch:TRIGger:LEVel:WINDow:LOWer..... | 472 |
| SEARch:TRIGger:LEVel:WINDow:UPPer..... | 472 |
| SEARch:TRIGger:PATtern:FUNCTion..... | 470 |
| SEARch:TRIGger:PATtern:LEVel<n>..... | 471 |
| SEARch:TRIGger:PATtern:LEVel<n>:DELTA..... | 471 |
| SEARch:TRIGger:PATtern:SOURce..... | 470 |
| SEARch:TRIGger:PATtern:WIDTh:DELTA..... | 472 |
| SEARch:TRIGger:PATtern:WIDTh:RANGe..... | 471 |
| SEARch:TRIGger:PATtern:WIDTh[:WIDTh]..... | 472 |
| SEARch:TRIGger:RISetime:DELTA..... | 466 |
| SEARch:TRIGger:RISetime:RANGe..... | 466 |
| SEARch:TRIGger:RISetime:SLOPe..... | 465 |
| SEARch:TRIGger:RISetime:TIME..... | 466 |
| SEARch:TRIGger:RUNT:DELTA..... | 468 |
| SEARch:TRIGger:RUNT:POLarity..... | 467 |
| SEARch:TRIGger:RUNT:RANGe..... | 467 |
| SEARch:TRIGger:RUNT:WIDTh..... | 468 |
| SEARch:TRIGger:WIDTh:DELTA..... | 464 |
| SEARch:TRIGger:WIDTh:LEVel..... | 463 |
| SEARch:TRIGger:WIDTh:LEVel:DELTA..... | 464 |
| SEARch:TRIGger:WIDTh:POLarity..... | 463 |
| SEARch:TRIGger:WIDTh:RANGe..... | 464 |
| SEARch:TRIGger:WIDTh:WIDTh..... | 464 |
| SEARch:TRIGger:WINDow:DELTA..... | 472 |

| | |
|--|-----|
| SEARch:TRIGger:WINDow:POLarity..... | 473 |
| SEARch:TRIGger:WINDow:RANGe..... | 473 |
| SEARch:TRIGger:WINDow:TIMerange..... | 473 |
| SEARch:TRIGger:WINDow:WIDTh..... | 474 |
| SINGle..... | 415 |
| SPECtrum:DIAGram:COLor:MAGNitude:MODE..... | 526 |
| SPECtrum:DIAGram:COLor:MAXimum[:LEVel]..... | 527 |
| SPECtrum:DIAGram:COLor:MINimum[:LEVel]..... | 527 |
| SPECtrum:DIAGram:COLor:SCHeme:FDOMain..... | 527 |
| SPECtrum:DIAGram:COLor:SCHeme:SPECtrogram..... | 527 |
| SPECtrum:DIAGram:SPECtrogram[:ENABle]..... | 527 |
| SPECtrum:FREQuency:AVERage:COMPlete?..... | 516 |
| SPECtrum:FREQuency:AVERage:COUNt..... | 516 |
| SPECtrum:FREQuency:BANDwidth[:RESolution]:AUTO..... | 526 |
| SPECtrum:FREQuency:BANDwidth[:RESolution]:RATio..... | 515 |
| SPECtrum:FREQuency:BANDwidth[:RESolution][:VALue]..... | 515 |
| SPECtrum:FREQuency:CENTer..... | 514 |
| SPECtrum:FREQuency:FULLspan..... | 515 |
| SPECtrum:FREQuency:MAGNitude:SCALE..... | 513 |
| SPECtrum:FREQuency:POSITION..... | 514 |
| SPECtrum:FREQuency:RESet..... | 517 |
| SPECtrum:FREQuency:SCALE..... | 514 |
| SPECtrum:FREQuency:SPAN..... | 515 |
| SPECtrum:FREQuency:START..... | 515 |
| SPECtrum:FREQuency:STOP..... | 515 |
| SPECtrum:FREQuency:WINDow:TYPE..... | 513 |
| SPECtrum:HISTory:CURRent..... | 480 |
| SPECtrum:HISTory:EXPort:NAME..... | 487 |
| SPECtrum:HISTory:EXPort:SAVE..... | 487 |
| SPECtrum:HISTory:PALL..... | 480 |
| SPECtrum:HISTory:PLAYer:SPEed..... | 481 |
| SPECtrum:HISTory:PLAYer:STATe..... | 482 |
| SPECtrum:HISTory:REPLay..... | 482 |
| SPECtrum:HISTory:START..... | 481 |
| SPECtrum:HISTory:STOP..... | 481 |
| SPECtrum:HISTory:TSABsolute:ALL?..... | 485 |
| SPECtrum:HISTory:TSABsolute?..... | 485 |
| SPECtrum:HISTory:TSDate:ALL?..... | 486 |
| SPECtrum:HISTory:TSDate?..... | 485 |
| SPECtrum:HISTory:TSRelative:ALL?..... | 484 |
| SPECtrum:HISTory:TSRelative?..... | 484 |
| SPECtrum:MARKer:RCOUNt?..... | 524 |
| SPECtrum:MARKer:REFerence:SETup:CMPeak..... | 522 |
| SPECtrum:MARKer:REFerence:SETup:CSCReen..... | 522 |
| SPECtrum:MARKer:REFerence:SETup:FREQuency..... | 523 |
| SPECtrum:MARKer:REFerence:SETup:INDex..... | 522 |
| SPECtrum:MARKer:REFerence:SETup:MODE..... | 522 |
| SPECtrum:MARKer:REFerence:SETup:SPAN..... | 523 |
| SPECtrum:MARKer:RESult<n>:ALL:DELTA?..... | 525 |
| SPECtrum:MARKer:RESult<n>:ALL?..... | 524 |

| | |
|---|-----|
| SPECTrum:MARKer:RESult<n>:DELTA? | 525 |
| SPECTrum:MARKer:RESult<n>:FREQuency:DELTA? | 525 |
| SPECTrum:MARKer:RESult<n>:FREQuency? | 525 |
| SPECTrum:MARKer:RESult<n>:LEVel:DELTA? | 526 |
| SPECTrum:MARKer:RESult<n>:LEVel? | 526 |
| SPECTrum:MARKer:RESult<n>? | 524 |
| SPECTrum:MARKer:RMARker:FREQuency? | 523 |
| SPECTrum:MARKer:RMARker:LEVel? | 523 |
| SPECTrum:MARKer:RMARker? | 523 |
| SPECTrum:MARKer:RMODE | 523 |
| SPECTrum:MARKer:RTABLE:ENABle | 520 |
| SPECTrum:MARKer:SETup:DISTance | 521 |
| SPECTrum:MARKer:SETup:EXCURsion | 521 |
| SPECTrum:MARKer:SETup:MLEVel | 521 |
| SPECTrum:MARKer:SETup:MMODE | 521 |
| SPECTrum:MARKer:SETup:MWIDth | 522 |
| SPECTrum:MARKer:SOURce | 521 |
| SPECTrum:MARKer[:ENABle] | 520 |
| SPECTrum:SOURce | 513 |
| SPECTrum:SPECTrogram:RESEt | 520 |
| SPECTrum:SPECTrogram:SCALe | 520 |
| SPECTrum:TIME:POSItion | 516 |
| SPECTrum:TIME:RANGe | 516 |
| SPECTrum:WAVEform:AVERAge:DATA:HEADer? | 518 |
| SPECTrum:WAVEform:AVERAge:DATA:POINts? | 518 |
| SPECTrum:WAVEform:AVERAge:DATA:XINCrement? | 518 |
| SPECTrum:WAVEform:AVERAge:DATA:XORigin? | 518 |
| SPECTrum:WAVEform:AVERAge:DATA:YINCrement? | 519 |
| SPECTrum:WAVEform:AVERAge:DATA:YORigin? | 519 |
| SPECTrum:WAVEform:AVERAge:DATA:YRESolution? | 519 |
| SPECTrum:WAVEform:AVERAge:DATA? | 517 |
| SPECTrum:WAVEform:AVERAge[:ENABle] | 516 |
| SPECTrum:WAVEform:MAXimum:DATA:HEADer? | 518 |
| SPECTrum:WAVEform:MAXimum:DATA:POINts? | 518 |
| SPECTrum:WAVEform:MAXimum:DATA:XINCrement? | 518 |
| SPECTrum:WAVEform:MAXimum:DATA:XORigin? | 518 |
| SPECTrum:WAVEform:MAXimum:DATA:YINCrement? | 519 |
| SPECTrum:WAVEform:MAXimum:DATA:YORigin? | 519 |
| SPECTrum:WAVEform:MAXimum:DATA:YRESolution? | 519 |
| SPECTrum:WAVEform:MAXimum:DATA? | 517 |
| SPECTrum:WAVEform:MAXimum[:ENABle] | 516 |
| SPECTrum:WAVEform:MINimum:DATA:HEADer? | 518 |
| SPECTrum:WAVEform:MINimum:DATA:POINts? | 518 |
| SPECTrum:WAVEform:MINimum:DATA:XINCrement? | 518 |
| SPECTrum:WAVEform:MINimum:DATA:XORigin? | 519 |
| SPECTrum:WAVEform:MINimum:DATA:YINCrement? | 519 |
| SPECTrum:WAVEform:MINimum:DATA:YORigin? | 519 |
| SPECTrum:WAVEform:MINimum:DATA:YRESolution? | 519 |
| SPECTrum:WAVEform:MINimum:DATA? | 518 |
| SPECTrum:WAVEform:MINimum[:ENABle] | 516 |

| | |
|--|-----|
| SPECTrum:WAVeform:SPECTrum:DATA:HEADer?..... | 518 |
| SPECTrum:WAVeform:SPECTrum:DATA:POINts?..... | 518 |
| SPECTrum:WAVeform:SPECTrum:DATA:XINCrement?..... | 518 |
| SPECTrum:WAVeform:SPECTrum:DATA:XORigin?..... | 519 |
| SPECTrum:WAVeform:SPECTrum:DATA:YINCrement?..... | 519 |
| SPECTrum:WAVeform:SPECTrum:DATA:YORigin?..... | 519 |
| SPECTrum:WAVeform:SPECTrum:DATA:YRESolution?..... | 519 |
| SPECTrum:WAVeform:SPECTrum:DATA?..... | 518 |
| SPECTrum:WAVeform:SPECTrum[:ENABLE]..... | 516 |
| SPECTrum[:STATE]..... | 512 |
| STATus:OPERation:CONDition?..... | 764 |
| STATus:OPERation:ENABLE..... | 764 |
| STATus:OPERation:NTRansition..... | 765 |
| STATus:OPERation:PTRansition..... | 765 |
| STATus:OPERation[:EVENT]?..... | 765 |
| STATus:PRESet..... | 767 |
| STATus:QUEStionable:ADCState:CONDition?..... | 767 |
| STATus:QUEStionable:ADCState:ENABLE..... | 767 |
| STATus:QUEStionable:ADCState:NTRansition..... | 768 |
| STATus:QUEStionable:ADCState:PTRansition..... | 769 |
| STATus:QUEStionable:ADCState[:EVENT]?..... | 768 |
| STATus:QUEStionable:CONDition?..... | 767 |
| STATus:QUEStionable:COVerload:CONDition?..... | 767 |
| STATus:QUEStionable:COVerload:ENABLE..... | 767 |
| STATus:QUEStionable:COVerload:NTRansition..... | 768 |
| STATus:QUEStionable:COVerload:PTRansition..... | 769 |
| STATus:QUEStionable:COVerload[:EVENT]?..... | 768 |
| STATus:QUEStionable:ENABLE..... | 767 |
| STATus:QUEStionable:LIMit:CONDition?..... | 767 |
| STATus:QUEStionable:LIMit:ENABLE..... | 768 |
| STATus:QUEStionable:LIMit:NTRansition..... | 768 |
| STATus:QUEStionable:LIMit:PTRansition..... | 769 |
| STATus:QUEStionable:LIMit[:EVENT]?..... | 768 |
| STATus:QUEStionable:MASK:CONDition?..... | 767 |
| STATus:QUEStionable:MASK:ENABLE..... | 768 |
| STATus:QUEStionable:MASK:NTRansition..... | 768 |
| STATus:QUEStionable:MASK:PTRansition..... | 769 |
| STATus:QUEStionable:MASK[:EVENT]?..... | 768 |
| STATus:QUEStionable:NTRansition..... | 768 |
| STATus:QUEStionable:PTRansition..... | 769 |
| STATus:QUEStionable[:EVENT]?..... | 768 |
| STOP..... | 416 |
| SYSTem:BEEPer:CONTRol:STATe..... | 567 |
| SYSTem:BEEPer:ERRor:STATe..... | 567 |
| SYSTem:BEEPer:TRIG:STATe..... | 568 |
| SYSTem:BEEPer[:IMMediate]..... | 568 |
| SYSTem:COMMunicate:INTERface:ETHernet:DHCP..... | 570 |
| SYSTem:COMMunicate:INTERface:ETHernet:GATeway..... | 570 |
| SYSTem:COMMunicate:INTERface:ETHernet:HTTPport..... | 571 |
| SYSTem:COMMunicate:INTERface:ETHernet:IPADdress..... | 570 |

| | |
|--|-----|
| SYSTem:COMMunicate:INTERface:ETHernet:IPPort..... | 570 |
| SYSTem:COMMunicate:INTERface:ETHernet:MACaddress?..... | 571 |
| SYSTem:COMMunicate:INTERface:ETHernet:SUBNet..... | 570 |
| SYSTem:COMMunicate:INTERface:ETHernet:TRANSfer..... | 571 |
| SYSTem:COMMunicate:INTERface:ETHernet:VXIPort..... | 570 |
| SYSTem:COMMunicate:INTERface:USB:CLASSs..... | 571 |
| SYSTem:COMMunicate:INTERface[:SElect]..... | 567 |
| SYSTem:DATE..... | 566 |
| SYSTem:DFPRint?..... | 569 |
| SYSTem:EDUCation:PRESet..... | 569 |
| SYSTem:ERRor:ALL?..... | 568 |
| SYSTem:ERRor[:NEXT]?..... | 568 |
| SYSTem:NAME..... | 566 |
| SYSTem:PRESet..... | 569 |
| SYSTem:SET..... | 568 |
| SYSTem:TIME..... | 567 |
| SYSTem:TREE?..... | 569 |
| TCOunter:ENABLE..... | 531 |
| TCOunter:RESult[:ACTual]:FREQuency?..... | 531 |
| TCOunter:RESult[:ACTual]:PERiod?..... | 531 |
| TCOunter:SOURce..... | 531 |
| TIMebase:ACQTime..... | 430 |
| TIMebase:DIVisions?..... | 430 |
| TIMebase:POSition..... | 429 |
| TIMebase:RANGe..... | 430 |
| TIMebase:RATime?..... | 430 |
| TIMebase:REFerence..... | 430 |
| TIMebase:ROLL:AUTomatic..... | 434 |
| TIMebase:ROLL:MTIME..... | 434 |
| TIMebase:SCALE..... | 429 |
| TIMebase:ZOOM:POSition..... | 452 |
| TIMebase:ZOOM:SCALE..... | 451 |
| TIMebase:ZOOM:STATe..... | 451 |
| TIMebase:ZOOM:TIME..... | 451 |
| TRIGger:A:ARINc:DATA:CONDition..... | 673 |
| TRIGger:A:ARINc:DATA:MAXimum..... | 674 |
| TRIGger:A:ARINc:DATA:MINimum..... | 674 |
| TRIGger:A:ARINc:DATA:OFFSet..... | 674 |
| TRIGger:A:ARINc:DATA:SIZE..... | 674 |
| TRIGger:A:ARINc:ERRor:CODing..... | 674 |
| TRIGger:A:ARINc:ERRor:GAP..... | 675 |
| TRIGger:A:ARINc:ERRor:PARity..... | 675 |
| TRIGger:A:ARINc:FORMat..... | 675 |
| TRIGger:A:ARINc:LABel:CONDition..... | 675 |
| TRIGger:A:ARINc:LABel:MAXimum..... | 676 |
| TRIGger:A:ARINc:LABel:MINimum..... | 676 |
| TRIGger:A:ARINc:SDI..... | 676 |
| TRIGger:A:ARINc:SSM..... | 676 |
| TRIGger:A:ARINc:TTIME:CONDition..... | 676 |
| TRIGger:A:ARINc:TTIME:MAXimum..... | 676 |

| | |
|---|-----|
| TRIGger:A:ARINc:TTIME:MINimum..... | 676 |
| TRIGger:A:ARINc:TYPE..... | 677 |
| TRIGger:A:ARINc:WORD:TYPE..... | 677 |
| TRIGger:A:CAN:ACKError..... | 613 |
| TRIGger:A:CAN:BITSterror..... | 613 |
| TRIGger:A:CAN:CRCError..... | 613 |
| TRIGger:A:CAN:DATA..... | 613 |
| TRIGger:A:CAN:DCONdition..... | 612 |
| TRIGger:A:CAN:DLC..... | 612 |
| TRIGger:A:CAN:FORMError..... | 614 |
| TRIGger:A:CAN:FTYPE..... | 611 |
| TRIGger:A:CAN:ICONdition..... | 612 |
| TRIGger:A:CAN:IDENtifier..... | 612 |
| TRIGger:A:CAN:ITYPE..... | 611 |
| TRIGger:A:CAN:TYPE..... | 611 |
| TRIGger:A:EDGE:COUPling..... | 439 |
| TRIGger:A:EDGE:FILTer:HFReject..... | 439 |
| TRIGger:A:EDGE:FILTer:NREJect..... | 440 |
| TRIGger:A:EDGE:SLOPe..... | 438 |
| TRIGger:A:FINDlevel..... | 438 |
| TRIGger:A:HOLDoff:MODE..... | 437 |
| TRIGger:A:HOLDoff:TIME..... | 438 |
| TRIGger:A:HYSTeresis..... | 439 |
| TRIGger:A:I2C:ACCess..... | 590 |
| TRIGger:A:I2C:ADDResS..... | 591 |
| TRIGger:A:I2C:AMODE..... | 591 |
| TRIGger:A:I2C:MODE..... | 590 |
| TRIGger:A:I2C:PATtern..... | 591 |
| TRIGger:A:I2C:PLENght..... | 592 |
| TRIGger:A:I2C:POFFset..... | 592 |
| TRIGger:A:I2S:CHANnel:LEFT:CONDItion..... | 643 |
| TRIGger:A:I2S:CHANnel:LEFT:DMAX..... | 643 |
| TRIGger:A:I2S:CHANnel:LEFT:DMIN..... | 643 |
| TRIGger:A:I2S:CHANnel:RIGHT:CONDItion..... | 644 |
| TRIGger:A:I2S:CHANnel:RIGHT:DMAX..... | 644 |
| TRIGger:A:I2S:CHANnel:RIGHT:DMIN..... | 644 |
| TRIGger:A:I2S:CHANnel:TDM<n>:CONDItion..... | 644 |
| TRIGger:A:I2S:CHANnel:TDM<n>:DMAX..... | 645 |
| TRIGger:A:I2S:CHANnel:TDM<n>:DMIN..... | 645 |
| TRIGger:A:I2S:FUNcTION..... | 645 |
| TRIGger:A:I2S:SOWords..... | 646 |
| TRIGger:A:I2S:TYPE..... | 645 |
| TRIGger:A:I2S:WINDow:LENGth..... | 646 |
| TRIGger:A:I2S:WSElect:SLOPe..... | 646 |
| TRIGger:A:I2S:WSSLOpe..... | 646 |
| TRIGger:A:LEVel<n>:HYSTeresis..... | 439 |
| TRIGger:A:LEVel<n>:RISetime:LOWer..... | 448 |
| TRIGger:A:LEVel<n>:RISetime:UPPer..... | 449 |
| TRIGger:A:LEVel<n>:RUNT:LOWer..... | 447 |
| TRIGger:A:LEVel<n>:RUNT:UPPer..... | 447 |

| | |
|---|-----|
| TRIGger:A:LEVel<n>[:VALue]..... | 438 |
| TRIGger:A:LIN:CHKSerror..... | 626 |
| TRIGger:A:LIN:DATA..... | 627 |
| TRIGger:A:LIN:DConDition..... | 628 |
| TRIGger:A:LIN:DLENgth..... | 628 |
| TRIGger:A:LIN:ICONdition..... | 627 |
| TRIGger:A:LIN:IDENtifier..... | 627 |
| TRIGger:A:LIN:IPERror..... | 627 |
| TRIGger:A:LIN:SYERror..... | 627 |
| TRIGger:A:LIN:TYPE..... | 626 |
| TRIGger:A:MILStd:COMMand:TYPE..... | 652 |
| TRIGger:A:MILStd:DATA:CONDiTion..... | 653 |
| TRIGger:A:MILStd:DATA:MAXimum..... | 653 |
| TRIGger:A:MILStd:DATA:MINimum..... | 653 |
| TRIGger:A:MILStd:DATA:OFFSet..... | 653 |
| TRIGger:A:MILStd:DATA:OFFSet:CONDiTion..... | 653 |
| TRIGger:A:MILStd:DATA:WORDs..... | 653 |
| TRIGger:A:MILStd:ERRor:MANChester..... | 653 |
| TRIGger:A:MILStd:ERRor:PARity..... | 654 |
| TRIGger:A:MILStd:ERRor:SYNC..... | 654 |
| TRIGger:A:MILStd:ERRor:TIMEout..... | 654 |
| TRIGger:A:MILStd:FRAMe..... | 654 |
| TRIGger:A:MILStd:MCODE:CODE..... | 654 |
| TRIGger:A:MILStd:MCODE:VALue..... | 655 |
| TRIGger:A:MILStd:MODE..... | 655 |
| TRIGger:A:MILStd:RTAddress:CONDiTion..... | 655 |
| TRIGger:A:MILStd:RTAddress:MAXimum..... | 655 |
| TRIGger:A:MILStd:RTAddress:MINimum..... | 655 |
| TRIGger:A:MILStd:SADdress:CONDiTion..... | 656 |
| TRIGger:A:MILStd:SADdress:MAXimum..... | 656 |
| TRIGger:A:MILStd:SADdress:MCADdress..... | 656 |
| TRIGger:A:MILStd:SADdress:MINimum..... | 656 |
| TRIGger:A:MILStd:STATus:BCReceivEd..... | 656 |
| TRIGger:A:MILStd:STATus:BUSY..... | 656 |
| TRIGger:A:MILStd:STATus:DBCaccept..... | 657 |
| TRIGger:A:MILStd:STATus:INSTRument..... | 657 |
| TRIGger:A:MILStd:STATus:MERRor..... | 657 |
| TRIGger:A:MILStd:STATus:SREQuest..... | 657 |
| TRIGger:A:MILStd:STATus:SUBSsystem..... | 657 |
| TRIGger:A:MILStd:STATus:TERMinal..... | 657 |
| TRIGger:A:MILStd:SYNC..... | 658 |
| TRIGger:A:MILStd:TRMode..... | 658 |
| TRIGger:A:MILStd:TTYPe..... | 658 |
| TRIGger:A:MILStd:TYPE..... | 658 |
| TRIGger:A:MILStd:WCOunt:CONDiTion..... | 658 |
| TRIGger:A:MILStd:WCOunt:MAXimum..... | 659 |
| TRIGger:A:MILStd:WCOunt:MINimum..... | 659 |
| TRIGger:A:MILStd:WORD..... | 659 |
| TRIGger:A:MODE..... | 436 |
| TRIGger:A:PATtern:CONDiTion..... | 445 |

| | |
|---------------------------------------|-----|
| TRIGger:A:PATtern:FUNCTion..... | 445 |
| TRIGger:A:PATtern:MODE..... | 446 |
| TRIGger:A:PATtern:SOURce..... | 445 |
| TRIGger:A:PATtern:WIDTh:DELTA..... | 447 |
| TRIGger:A:PATtern:WIDTh:RANGe..... | 446 |
| TRIGger:A:PATtern:WIDTh[:WIDTh]..... | 446 |
| TRIGger:A:RISetime:DELTA..... | 449 |
| TRIGger:A:RISetime:RANGe..... | 449 |
| TRIGger:A:RISetime:SLOPe..... | 449 |
| TRIGger:A:RISetime:TIME..... | 450 |
| TRIGger:A:RUNT:DELTA..... | 447 |
| TRIGger:A:RUNT:POLarity..... | 448 |
| TRIGger:A:RUNT:RANGe..... | 448 |
| TRIGger:A:RUNT:WIDTh..... | 448 |
| TRIGger:A:SOURce..... | 436 |
| TRIGger:A:SOURce:SPI..... | 583 |
| TRIGger:A:SOURce:UART..... | 602 |
| TRIGger:A:SPI:MODE..... | 583 |
| TRIGger:A:SPI:PATtern..... | 584 |
| TRIGger:A:SPI:PLENght..... | 584 |
| TRIGger:A:SPI:POFFset..... | 584 |
| TRIGger:A:TIMEout:RANGe..... | 450 |
| TRIGger:A:TIMEout:TIME..... | 450 |
| TRIGger:A:TV:FIELD..... | 444 |
| TRIGger:A:TV:LINE..... | 444 |
| TRIGger:A:TV:POLarity..... | 443 |
| TRIGger:A:TV:STANdard..... | 443 |
| TRIGger:A:TYPE..... | 437 |
| TRIGger:A:UART:MODE..... | 602 |
| TRIGger:A:UART:PATtern..... | 603 |
| TRIGger:A:UART:PLENght..... | 603 |
| TRIGger:A:UART:POFFset..... | 603 |
| TRIGger:A:WIDTh:DELTA..... | 443 |
| TRIGger:A:WIDTh:POLarity..... | 442 |
| TRIGger:A:WIDTh:RANGe..... | 442 |
| TRIGger:A:WIDTh:WIDTh..... | 442 |
| TRIGger:B:DELay..... | 441 |
| TRIGger:B:EDGE:SLOPe..... | 441 |
| TRIGger:B:ENABle..... | 440 |
| TRIGger:B:EVENT:COUNT..... | 441 |
| TRIGger:B:MODE..... | 441 |
| TRIGger:B:SOURce..... | 440 |
| TRIGger:OUT:MODE..... | 572 |
| TRIGger:OUT:PLENght..... | 572 |
| TRIGger:OUT:POLarity..... | 572 |
| WGENerator:ARBitrary:RANGe:START..... | 751 |
| WGENerator:ARBitrary:RANGe:STOP..... | 751 |
| WGENerator:ARBitrary:SOURce..... | 751 |
| WGENerator:ARBitrary:UPDate..... | 752 |
| WGENerator:ARBitrary:VISible..... | 752 |

| | |
|---|-----|
| WGENerator:ARbitrary[:FILE]:NAME..... | 752 |
| WGENerator:ARbitrary[:FILE]:OPEN..... | 752 |
| WGENerator:BURSt:ITIME..... | 752 |
| WGENerator:BURSt:NCYCLE..... | 752 |
| WGENerator:BURSt:PHASe..... | 753 |
| WGENerator:BURSt[:STATe]..... | 753 |
| WGENerator:FREQuency..... | 749 |
| WGENerator:FUNCTion..... | 749 |
| WGENerator:FUNCTion:EXPOntial:POLarity..... | 750 |
| WGENerator:FUNCTion:PULSe:DCYCLE..... | 749 |
| WGENerator:FUNCTion:PULSe:ETIME..... | 750 |
| WGENerator:FUNCTion:RAMP:POLarity..... | 750 |
| WGENerator:MODulation:AM:DEPTH..... | 754 |
| WGENerator:MODulation:AM:FREQuency..... | 754 |
| WGENerator:MODulation:ASK:DEPTH..... | 755 |
| WGENerator:MODulation:ASK:FREQuency..... | 755 |
| WGENerator:MODulation:FM:DEVIation..... | 755 |
| WGENerator:MODulation:FM:FREQuency..... | 754 |
| WGENerator:MODulation:FSK:HFREquency..... | 755 |
| WGENerator:MODulation:FSK:RATE..... | 755 |
| WGENerator:MODulation:FUNCTion..... | 753 |
| WGENerator:MODulation:RAMP:POLarity..... | 755 |
| WGENerator:MODulation:TYPE..... | 754 |
| WGENerator:MODulation[:ENABLE]..... | 753 |
| WGENerator:NOISe:ABSolute..... | 750 |
| WGENerator:NOISe:RELative..... | 750 |
| WGENerator:OUTPut:LOAD..... | 751 |
| WGENerator:OUTPut[:ENABLE]..... | 751 |
| WGENerator:SWEep:FEND..... | 756 |
| WGENerator:SWEep:FStArt..... | 756 |
| WGENerator:SWEep:TIME..... | 756 |
| WGENerator:SWEep:TYPE..... | 756 |
| WGENerator:SWEep[:ENABLE]..... | 756 |
| WGENerator:TRIngle:SYMMetry..... | 750 |
| WGENerator:VOLTagE..... | 749 |
| WGENerator:VOLTagE:OFFSet..... | 749 |