

Synthesized Function Generator

SFG-1000 Series

USER MANUAL

GW INSTEK PART NO. 82FG-10030MA1



ISO-9001 CERTIFIED MANUFACTURER

GW INSTEK

This manual contains proprietary information, which is protected by copyrights. All rights are reserved. No part of this manual may be photocopied, reproduced or translated to another language without prior written consent of Good Will company.

The information in this manual was correct at the time of printing. However, Good Will continues to improve products and reserves the rights to change specification, equipment, and maintenance procedures at any time without notice.

Good Will Instrument Co., Ltd.

No. 7-1, Jhongsing Rd., Tucheng City, Taipei County 236, Taiwan.

Table of Contents

SAFETY INSTRUCTIONS	5
Safety Symbols	5
Safety Guidelines	5
GETTING STARTED	8
Technical background	9
Lineup/Features	11
Front Panel	12
Rear Panel.....	15
Set Up.....	16
Operation Shortcuts.....	18
SINE/SQUARE/TRIANGLE WAVE	19
Activate waveform	20
Set Frequency.....	20
Set Amplitude	22
Set Duty Cycle (Square Waveform).....	23
Set Offset.....	23
TTL OUTPUT	25
Activate TTL.....	25
Set Frequency.....	26
Set Duty Cycle	27
APPLICATION EXAMPLES	28
Reference Signal for PLL System.....	28
Trouble-Shooting Signal Source	28
Transistor DC Bias Characteristics Test.....	29
Amplifier Over-Load Characteristic Test.....	30
Amplifier Transient Characteristics Test.....	30

Logic Circuit Test.....	32
Impedance Matching Network Test	32
Speaker Driver Test.....	33
FAQ	34
APPENDIX.....	35
Fuse Replacement	35
Specification	37
Declaration of Conformity.....	39
INDEX	40

S SAFETY INSTRUCTIONS

This chapter contains important safety instructions that you must follow when operating SFG-1000 series and when keeping it in storage. Read the following before any operation to insure your safety and to keep the best condition for SFG-1000 series.

Safety Symbols

These safety symbols may appear in this manual or on SFG-1000 series.



WARNING

Warning: Identifies conditions or practices that could result in injury or loss of life.



CAUTION

Caution: Identifies conditions or practices that could result in damage to SFG-1000 series or to other properties.



Attention Refer to the Manual



Earth (ground) Terminal

Safety Guidelines

General Guideline



CAUTION

- Do not place any heavy object on SFG-1000 series.
- Avoid severe impacts or handling that leads to damage.
- Do not discharge static electricity to SFG-1000 series.
- Use only mating connectors, for the terminals.
- Do not block or obstruct cooling vent opening.
- Do not perform measurements at power source and building installation site (Note below).
- Do not disassemble SFG-1000 series unless you are qualified as service personnel.

(Note) EN 61010-1:2001 specifies the measurement categories and their requirements as follows. SFG-1000 series falls under category II.

- Measurement category IV is for measurement performed at the source of low-voltage installation.
- Measurement category III is for measurement performed in the building installation.
- Measurement category II is for measurement performed on the circuits directly connected to the low voltage installation.

Power Supply



WARNING

- Input voltage: 100/120/220/240V AC $\pm 10\%$, 50/60Hz (fixed voltage rating, factory installed)
- The power supply voltage should not fluctuate more than 10%.
- Connect the protective grounding conductor of the power cord to earth ground, to avoid electrical shock.

Fuse



WARNING

- Fuse type: T0.16A/ 250V (for 220V/240V $\pm 10\%$ rating), T0.315A/ 250V (for 100V/120V $\pm 10\%$ rating)
- Replace the fuse with the specified type and rating only, for continued fire protection. For fuse replacement details, see page35.
- Disconnect the power cord before fuse replacement.
- Make sure the cause of the fuse blowout is fixed before fuse replacement.

Cleaning

SFG-1000 series

- Disconnect the power cord before cleaning.
- Use a soft cloth dampened in a solution of mild detergent and water. Do not spray any liquid into SFG-1000 series.
- Do not use chemicals or cleaners containing harsh materials such as benzene, toluene, xylene, and acetone.

Operation

Environment

- Location: Indoor, no direct sunlight, dust free, almost non-conductive pollution (Note below)
- Relative Humidity: < 80%
- Altitude: < 2000m
- Temperature: 0°C to 40°C

(Note) EN 61010-1:2001 specifies the pollution degrees and their requirements as follows. SFG-1000 series falls under degree 2. Pollution refers to “addition of foreign matter, solid, liquid, or gaseous (ionized gases), that may produce a reduction of dielectric strength or surface resistivity”.

- Pollution degree 1: No pollution or only dry, non-conductive pollution occurs. The pollution has no influence.
- Pollution degree 2: Normally only non-conductive pollution occurs. Occasionally, however, a temporary conductivity caused by condensation must be expected.
- Pollution degree 3: Conductive pollution occurs, or dry, non-conductive pollution occurs which becomes conductive due to condensation which is expected. In such conditions, equipment is normally protected against exposure to direct sunlight, precipitation, and full wind pressure, but neither temperature nor humidity is controlled.

Storage	• Location: Indoor
Environment	• Relative Humidity: < 70%
	• Temperature: -10°C to 70°C

Power cord for the United Kingdom

When using SFG-1000 series in the United Kingdom, make sure the power cord meets the following safety instructions.

NOTE: This lead / appliance must only be wired by competent persons



WARNING: THIS APPLIANCE MUST BE EARTHED

IMPORTANT: The wires in this lead are coloured in accordance with the following code:

Green/ Yellow: Earth
 Blue: Neutral
 Brown: Live (Phase)



As the colours of the wires in main leads may not correspond with the colours marking identified in your plug/appliance, proceed as follows:

The wire which is coloured Green & Yellow must be connected to the Earth terminal marked with the letter E or by the earth symbol  or coloured Green or Green & Yellow. The wire which is coloured Blue must be connected to the terminal which is marked with the letter N or coloured Blue or Black.

The wire which is coloured Brown must be connected to the terminal marked with the letter L or P or coloured Brown or Red.

If in doubt, consult the instructions provided with the equipment or contact the supplier. This cable/appliance should be protected by a suitably rated and approved HBC mains fuse: refer to the rating information on the equipment and/or user instructions for details. As a guide, cable of 0.75mm² should be protected by a 3A or 5A fuse. Larger conductors would normally require 13A types, depending on the connection method used.

Any moulded mains connector that requires removal /replacement must be destroyed by removal of any fuse & fuse carrier and disposed of immediately, as a plug with bared wires is hazardous if engaged in live socket. Any re-wiring must be carried out in accordance with the information detailed on this label.

G ETTING STARTED

This chapter describes SFG-1000 series in a nutshell, including main features and front/rear/display introduction. Follow the Set Up section to properly install and power up SFG-1000 series.



SFG-1000 series overview	Technical background	9
	Series lineup	11
	Main features	11
Panel introduction	Main Display	12
	Entry keys	13
	Others	14
	Rear Panel	15
Setup	Tilt stand	16
	Power up	17
	Functionality check	17
Quick reference	Operation Shortcuts	18

Technical background

Traditional
function
generators

SFG-1000 series uses the latest Direct Digital Synthesis (DDS) technology to generate stable, high resolution output frequency. The DDS technology solves several problems encountered in traditional function generators, as follows.

Constant current circuit methodology

This analog function generating method uses a constant current source circuit built with discrete components such as capacitors and resistors. Temperature change inside the generator greatly affects the components characteristics which lead to output frequency change. The results are poor accuracy and stability.

DDS
methodology

In DDS, the waveform data is contained in and generated from a memory. A clock controls the counter which points to the data address. The memory output is converted into analog signal by a digital to analog converter (DAC) followed by a low pass filter. The resolution is expressed as $f_s/2^k$ where f_s is the frequency and k is the control word, which contains more than 28bits. Because the frequency generation is referred to clock signal, this achieves much higher frequency stability and resolution than the traditional function generators.

Block diagram **DDS synthesizer consists of Phase accumulator (counter), lookout table data (ROM), Digital-to-analog converter (DAC), and Low-pass filter (LPF).**

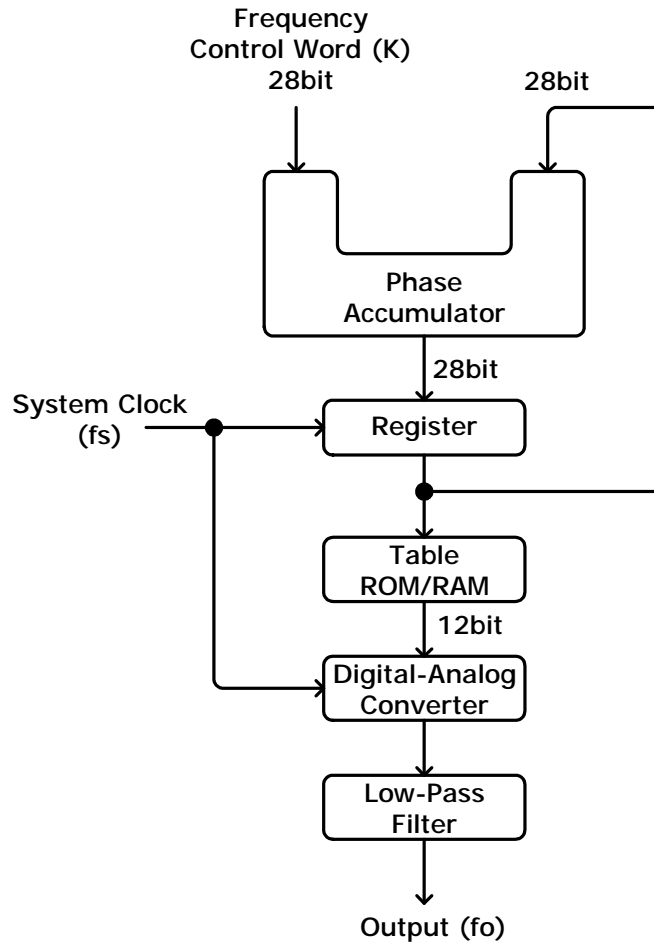

The phase accumulator adds the frequency control word K at every clock cycle f_s . The accumulator output points to a location in the Table ROM/RAM. The DAC converts the digital data into an analog waveform. The LPF filters out the clock frequency to provide a pure waveform.

Lineup/Features

Series lineup

Lineup \ Features	Frequency	Offset	TTL output	-40dB attn.	Voltage display
SFG-1003	3MHz	●	●	●	—
SFG-1013	3MHz	●	●	●	●

Main features

Performance	<ul style="list-style-type: none"> • High resolution using DDS technology • High frequency accuracy: ± 20ppm • Low distortion: -55dBc @ ≤ 200kHz • High resolution 100mHz
Features	<ul style="list-style-type: none"> • Digital user interface with 6-digit LED display • Various output waveforms: Sine, Square, and Triangle • TTL output • Amplitude control • -40dB attenuation • Duty control • Variable DC offset control • Output On/Off control • Voltage display (SFG-1013) • Output overload protection
Interface	<ul style="list-style-type: none"> • Frequency output • TTL output



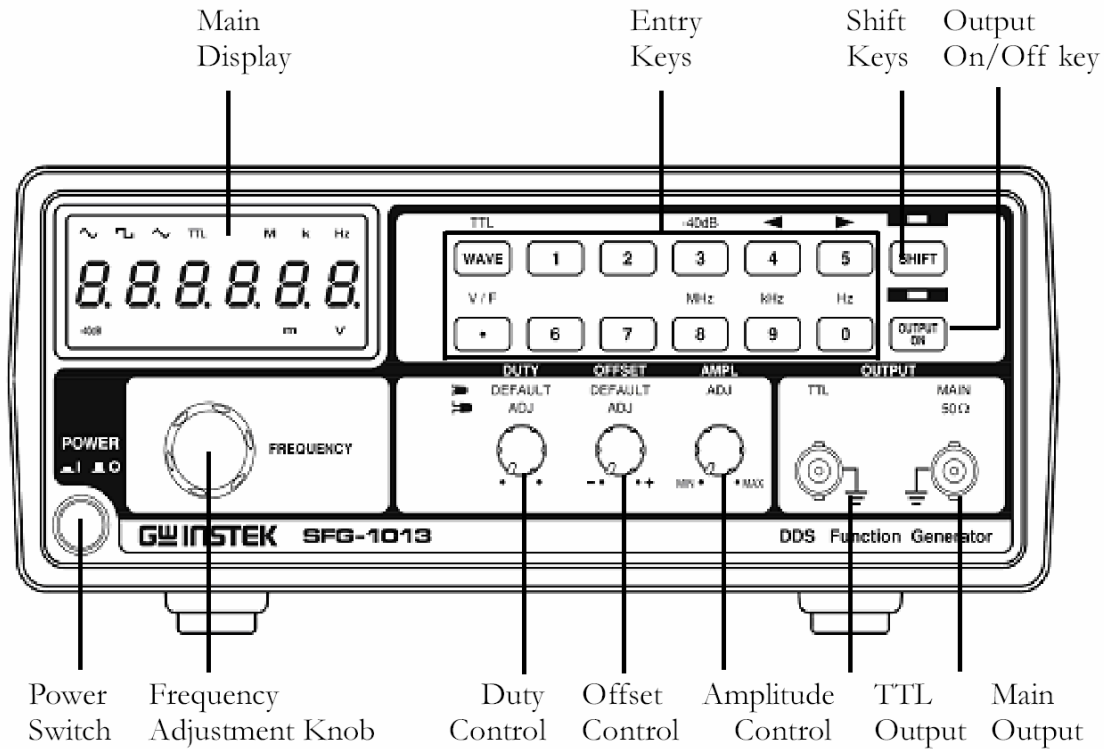

Front Panel

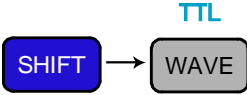

Main Display

7 segment LED		Shows frequency and voltage.
TTL indicator	TTL	Indicates that the TTL output is enabled. For details, see page25.
Waveform indicator		Indicates the waveform shape: Sine, Square, and Triangle.
Frequency indicator	M k Hz	Indicates the output frequency: MHz, kHz, or Hz.
Voltage indicator (SFG-1013 only)	m V	Indicates Voltage unit: mV, or V. For voltage measurement detail, see page22.
-40dB indicator (SFG-1013 only)	-40dB	Indicates -40dB attenuation is activated. For details, see page22.

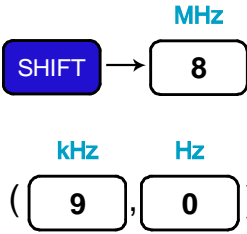
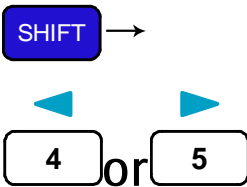
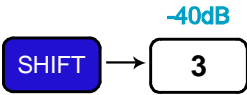
Entry keys

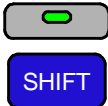
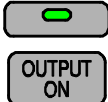
Waveform key		Selects the waveform: sine, square, and triangle. For details, see page20.
TTL activation		Activates TTL output. For details, see page25.
Numerical keys		Specifies frequency.
Frequency unit selection		Specifies the frequency unit: MHz, kHz, or Hz.
Cursor selection		Moves the cursor (frequency editing point) left or right. For details, see page21.
-40dB attenuation (SFG-1013 only)		Attenuates amplitude by -40dB. For details, see page22. Key operation is for SFG-1013 only.
Frequency / Voltage display selection (SFG-1013 only)		Switches the display between frequency and voltage. For details, see page22. For SFG-1013 only.
Shift key		Selects the 2 nd function associated to the entry keys. The LED lights when Shift is activated.
Output On/Off key		Turns the output On/Off. The LED lights when the output is On.

Others

Frequency editing knob

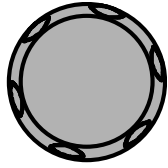

Increases (right turn) or decreases (left turn) the frequency.

Main output

OUTPUT
50Ω

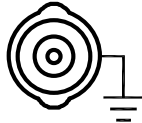

Outputs sine, square, and triangle waveform. BNC, 50Ω output impedance. For details, see page20.

TTL output

TTL
OUTPUT

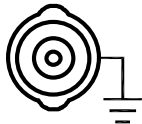

Outputs TTL output waveform, BNC terminal. For TTL mode details, see page25.

Amplitude control

AMPL

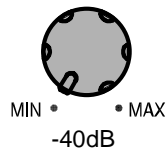

Sets the sine/square/triangle waveform amplitude. Turn left (decrease) or right (increase).

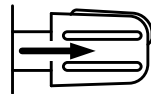

(SFG-1003 only) When pulled out, attenuates the sine / square / triangle waveform amplitude by -40dB. For details, see page22.

DC offset control

OFFSET

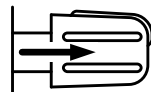

When pulled out, sets the DC offset level for sine/square/triangle waveform. Turn left (decrease) or right (increase). The range is -5V ~ +5V, in 50Ω load. For details, see page23.

Duty cycle control

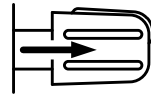

When pulled out, sets the square or TTL wave duty cycle. Turn left (decrease) or right (increase). The range is 25% ~ 75%. For details, see page23 (square wave) or page27 (TTL).

Power switch

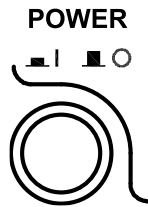

Turns the main power On/Off. For power up sequence, see page17.

Rear Panel

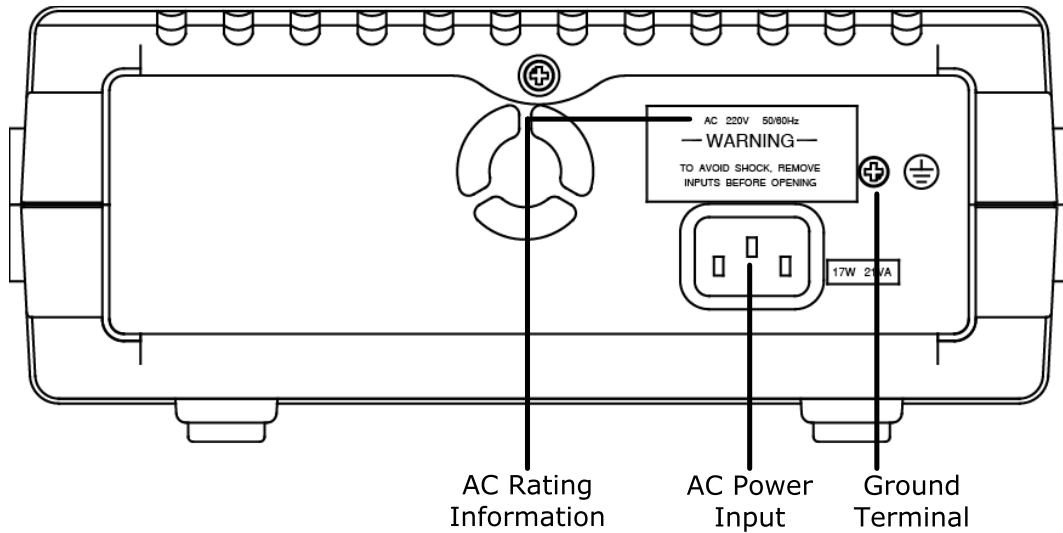

AC Rating Information

SFG-1000 series has fixed AC line voltage: 100, 120, 220, or 240V (factory installed setting). The label shows the applicable rating.

AC Power Input

Accepts the AC power cord. 100, 120, 220, or 240V, $\pm 10\%$, 50/60Hz.

Ground Terminal

The safety ground terminal. Use this terminal for common ground connection.

Set Up

Tilt stand

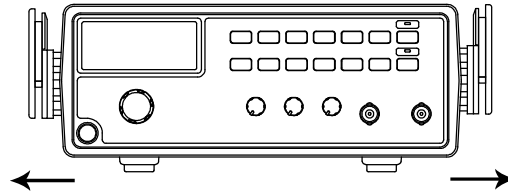

Pull out the handle sideways and rotate it.

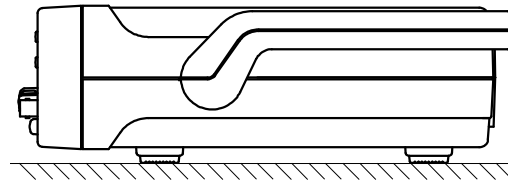

Place SFG horizontally,

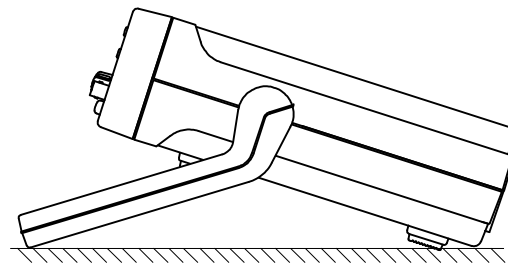

Or tilt stand.

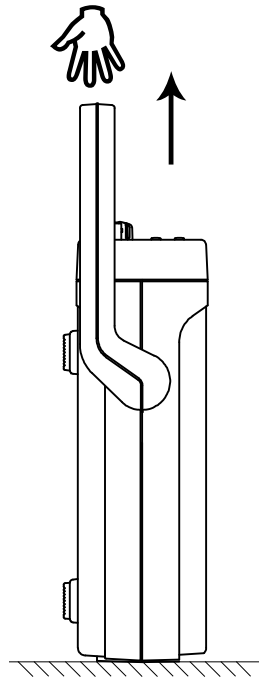

Place the handle vertically for hand carry.

Power up



1. Check the voltage level displayed on the label(1) and make sure it is identical to the AC line. Then connect the power cord(2).

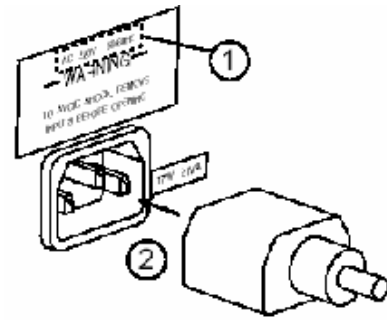

2. Push and turn On the main power switch on the front panel.

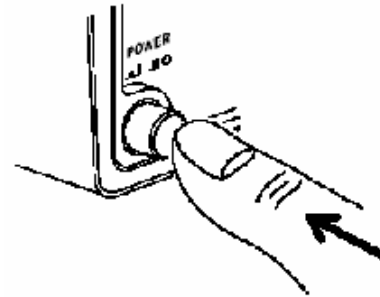

3. The display shows the default setup:
Sine wave, 1kHz

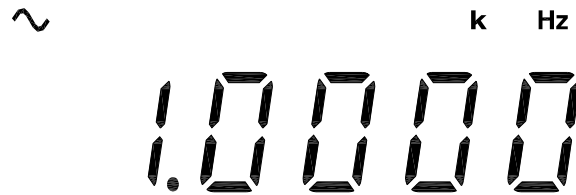

Functionality check

1. Connect SFG main output to measurement device such as oscilloscope.

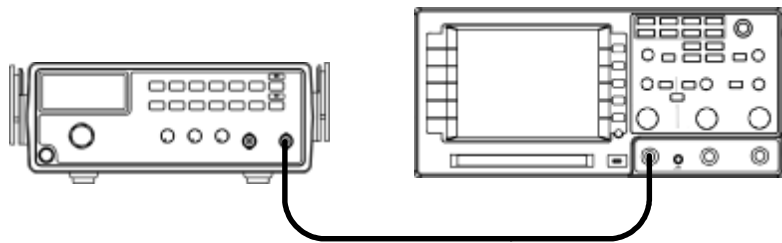

2. Press the output key. The output is activated and the LED turns On.

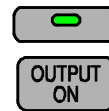

3. Observe the output waveform: 1kHz, sine wave.

Operation Shortcuts

Sine wave
250Hz, -40dB
amplitude

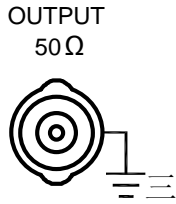

1. Press Wave key and select Sine



2. Press 2 + 5 + 0 + Shift + 0(Hz) key

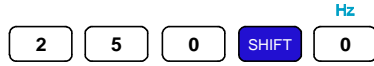

3. (SFG-1003) Press Output key, then pull Amplitude knob

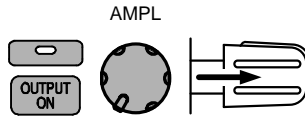

4. (SFG-1013) Press Output key, then press Shift + 3 (-40dB) key



Triangle wave
8kHz,+2V Offset

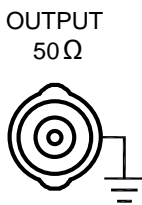

1. Press Wave key and select Triangle



2. Press 8 + Shift + 9(kHz) key



3. Press Output key, then pull Offset knob and Rotate

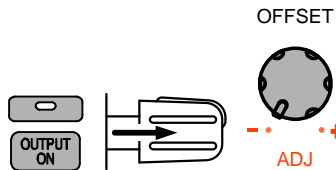

Square Wave
1MHz, 45% duty

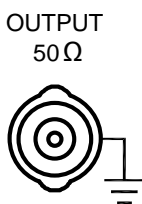

1. Press Wave key and select Square



2. Press 1 + Shift + 8(MHz) key



3. Press Output key, then pull Duty knob and rotate

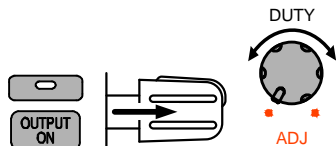

TTL Output 10kHz

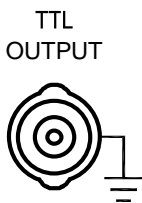

1. Press Output key



2. Press Shift + Wave (TTL) key



3. Press 1 + 0 + Shift + 9(kHz) key



SINE/SQUARE/TRIANGLE WAVE

Select waveform	Activate waveform	20
Set frequency	Enter frequency	20
	Edit frequency	21
	Maximum frequency limit error	21
	Minimum frequency limit error.....	22
Set amplitude	Set Amplitude	22
	View amplitude (SFG-1013).....	22
	Attenuate by -40dB.....	22
Set duty cycle (square wave)	Enter duty cycle.....	23
Set offset	Activate offset	23
	Adjust offset	23
	Limitation	24

Activate waveform

Sine / Square / Triangle



1. Press the wave key repeatedly. The corresponding indicator appears on the display.



Sine waveform



Square waveform



Triangle waveform



2. Press the output key. The LED turns On.

OUTPUT
50Ω

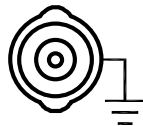

3. The waveform comes out from the main terminal.
10Vp-p (50Ω load)
20Vp-p (no load)

Set Frequency

Enter frequency

Enter the waveform frequency using the numerical keys.

1.2MHz MHz

1 • 2 SHIFT 8

37kHz kHz

3 7 SHIFT 9

45Hz Hz

4 5 SHIFT 0

Edit frequency

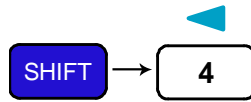

Left cursor key moves the active cursor left.

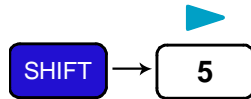
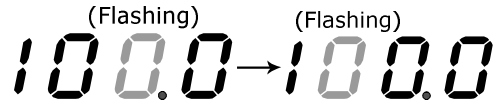

Right cursor key moves the active cursor right.

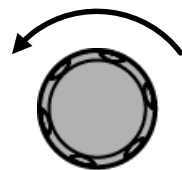
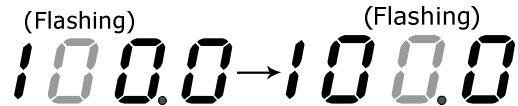

Turn the Frequency knob left to decrease the frequency.

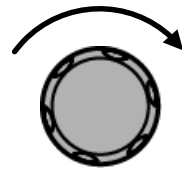
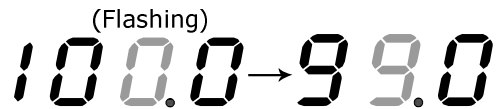

Turn the frequency knob right to increase the frequency.

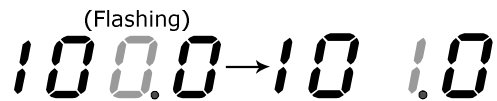

Maximum frequency limit error

For full error message list, see page37.

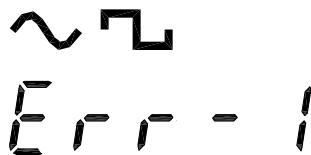

Sine and square waveform frequency is limited to maximum 3MHz. When the input exceeds it, an error message (Err-1) appears and forces the frequency to 3MHz.

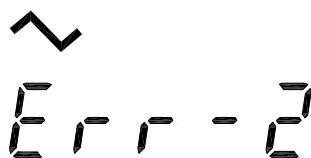

Triangle waveform frequency is limited to maximum 1MHz. When the input exceeds it, an error message (Err-2) appears and forces the frequency to 1MHz.

Minimum frequency limit error

For full error message list, see page37.

Err - 4

The minimum frequency is 0.1Hz. When the frequency input becomes less than 0.1Hz, an error message (Err-4) appears and forces the frequency to 0.1Hz.

Set Amplitude

Amplitude setting does not apply to TTL output (page25).

Set Amplitude

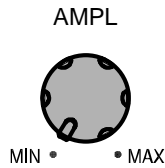

Turn the Amplitude knob right (increase) or left (decrease).

The range is 2mVpp ~ 10Vpp for 50Ω output impedance.

View amplitude (SFG-1013)

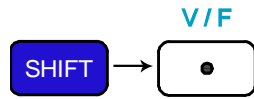

To view the voltage level (amplitude), press the Shift key and dot (V/F) key. The display shows the voltage level. Repeat this procedure to go back to the frequency level view.

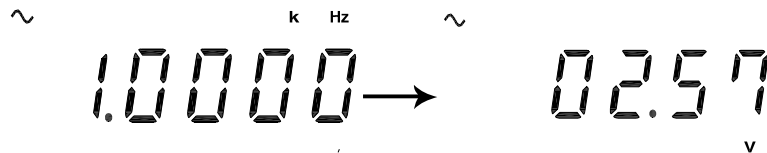

Attenuate by -40dB

Both SFG-1003 and SFG-1013 can attenuate the main output by -40dB, in different method.

SFG-1003

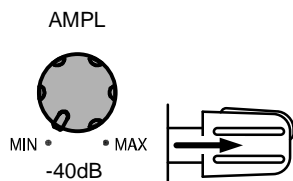

Pull out the Amplitude knob. The output amplitude is attenuated by -40dB.

SFG-1013

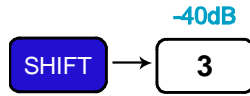

Press the Shift key, then 3 (-40dB). The main output is attenuated by -40dB, and the -40dB display indicator in the display turns On.



Set Duty Cycle (Square Waveform)

The duty cycle setting is not available in sine/triangle waveform.

Enter duty cycle

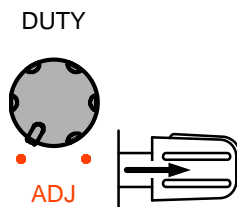

Pull out the Duty knob. Turn right (left) to increase (decrease) the duty cycle. The default is set at 50%.

Range 25% ~ 75%

Set Offset

Offset setting does not apply to TTL output (page25).

Activate offset

SFG can add or delete offset to the sine/square/triangle waveform, thus changing the waveform vertical position.

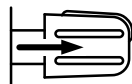

Pull the OFFSET knob to turn On Offset setting.

Adjust offset



Turn the knob right (higher position) or left (lower position).

Range -5V ~ +5V for 50Ω output load

Limitation



Note that the output amplitude, including the offset, is still limited to:

-5 ~ +5V (50Ω load)

-10 ~ +10V (no load)

Therefore excessive offset leads to peak clip as below.

Positive peak clip (50Ω)

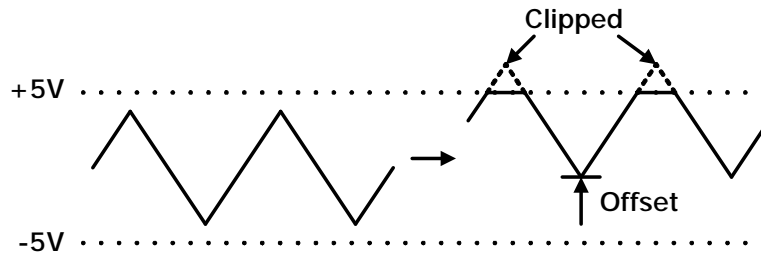

Negative peak clip (50Ω)

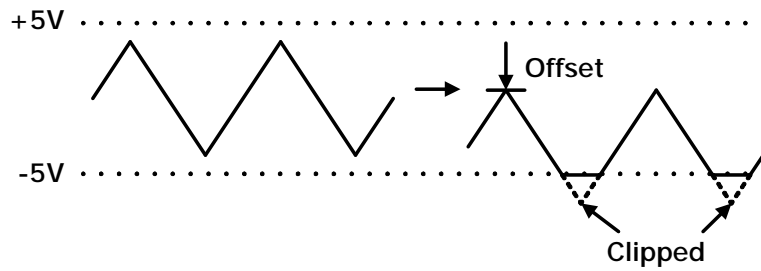

TTL OUTPUT

Activate TTL	Activate TTL.....	25
Set frequency	Enter frequency.....	26
	Edit frequency.....	26
	Maximum frequency limit error	27
	Minimum frequency limit error.....	27
Set duty cycle	Enter duty cycle.....	27

Activate TTL

Select TTL

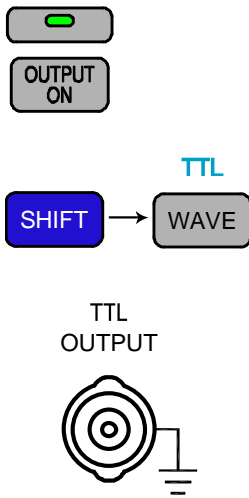

1. Press the Output key. The LED turns On. (TTL does not activate unless the output is already On)
2. Press the Shift key, then the Wave key. TTL indicator appears on the display.
3. The waveform comes out from the TTL output terminal. Level: $\geq 3V_{p-p}$

Set Frequency

Enter frequency

Enter the waveform frequency using the numerical keys.

1.2MHz

1 • 2 **SHIFT** 8 MHz

37kHz

3 7 **SHIFT** 9 kHz

45Hz

4 5 **SHIFT** 0 Hz

Edit frequency

SHIFT → 4 ◀ Left cursor key moves the active cursor left.

(Flashing) (Flashing)
100.0 → 100.0

SHIFT → 5 ▶ Right cursor key moves the active cursor right.

(Flashing) (Flashing)
100.0 → 100.0

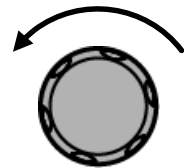

Turn the Frequency knob left to decrease the frequency.

(Flashing)
100.0 → 99.0

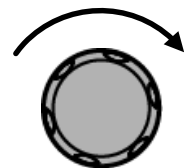

Turn the frequency knob right to increase the frequency.

(Flashing)
100.0 → 10 1.0

Maximum frequency limit error	For full error message list, see page37.	
	TTL Err - 1	TTL frequency is limited to maximum 3MHz. When the input exceeds it, an error message (Err-1) appears and forces the frequency to 3MHz.

Minimum frequency limit error	For full error message list, see page37.	
	Err - 4	The minimum frequency is 0.1Hz. When the frequency input becomes less than 0.1Hz, an error message (Err-4) appears and forces the frequency to 0.1 Hz.

Set Duty Cycle

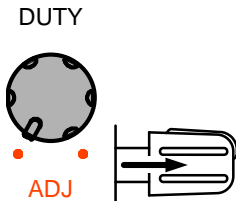
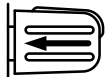
Enter duty cycle		1. Pull out the Duty knob. Turn right (left) to increase (decrease) the duty cycle. The default is set at 50%.
		2. Press the Duty knob. The duty cycle is reset to 50%.

Range	25% ~ 75%
-------	-----------

A APPLICATION EXAMPLES

Reference Signal for PLL System

Description The SFG output can be used as a cost-effective reference signal for Phase-Locked-Loop system. Directly connect SFG output to PLL input.

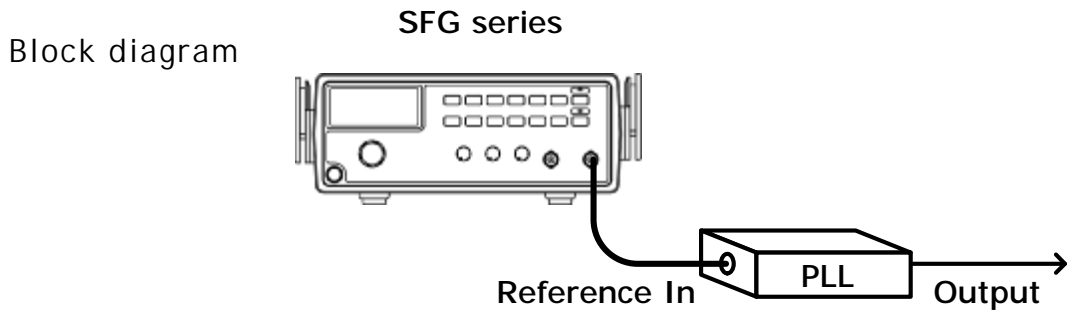

Trouble-Shooting Signal Source

Description The SFG output can be used as the signal source to test the failed part in a circuit system. Isolate the problematic part from the rest, feed the SFG output as a stimulus, and observe the outcome using an oscilloscope.

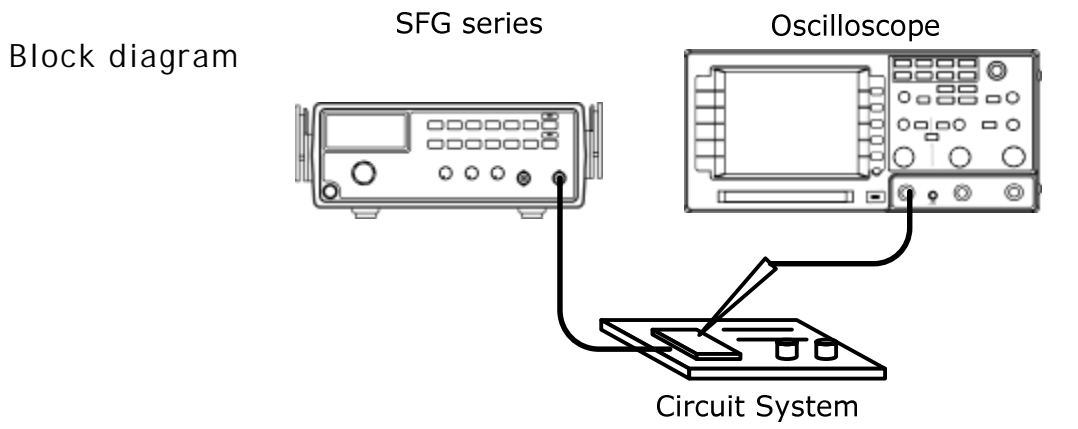

Transistor DC Bias Characteristics Test

Description Use SFG-1000 series as the signal source for a transistor. Compare the transistor input/output waveform using the oscilloscope. Adjust the DC voltage source to find out the maximum output without distorting the waveform.

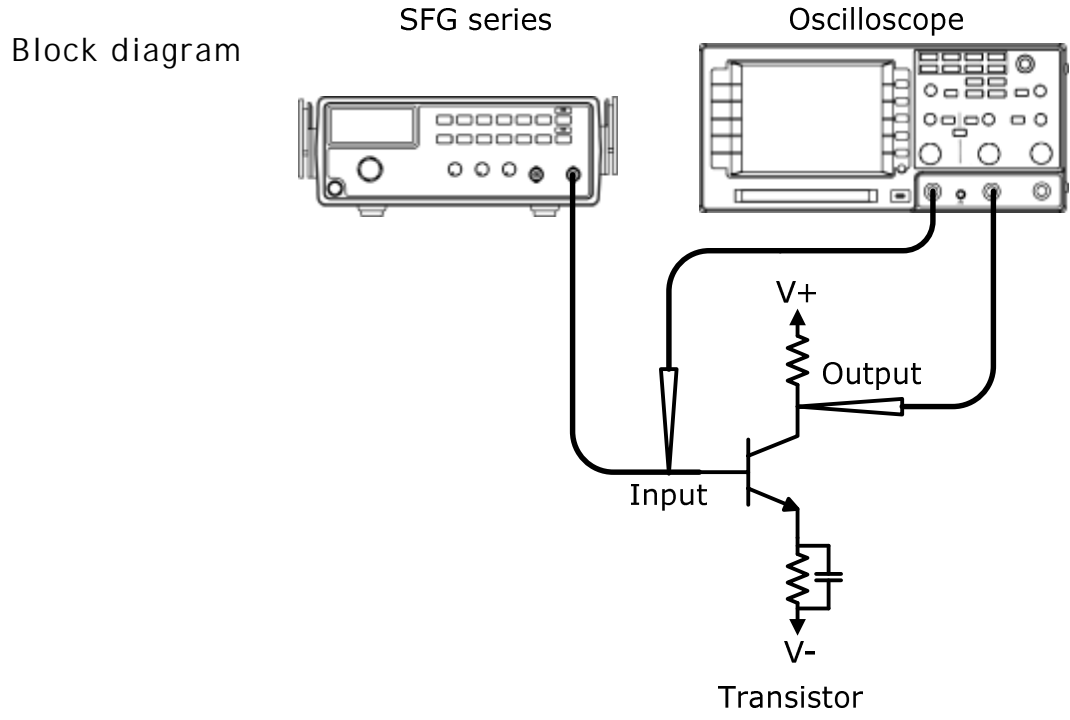

Oscilloscope display

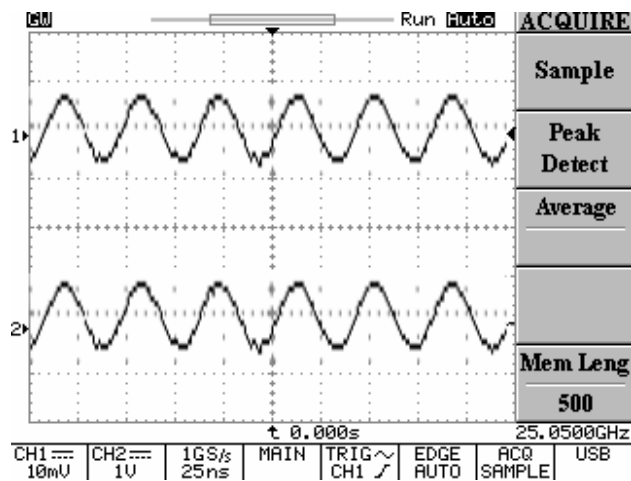

Amplifier Over-Load Characteristic Test

Description Use the triangle wave output from SFG-1000 series to check the amplifier output distortion caused by overload. The common sine wave is not the ideal source in this case. Observe the linearity of the triangle waveform using an oscilloscope.

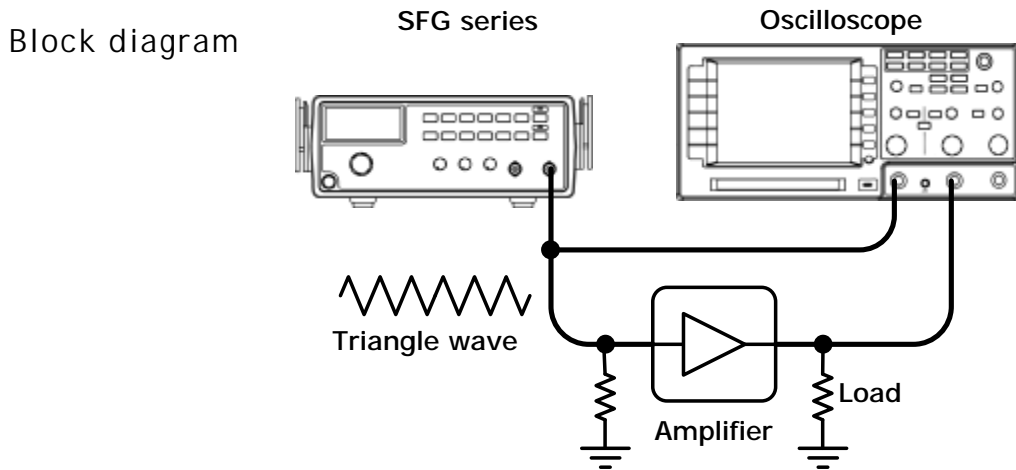





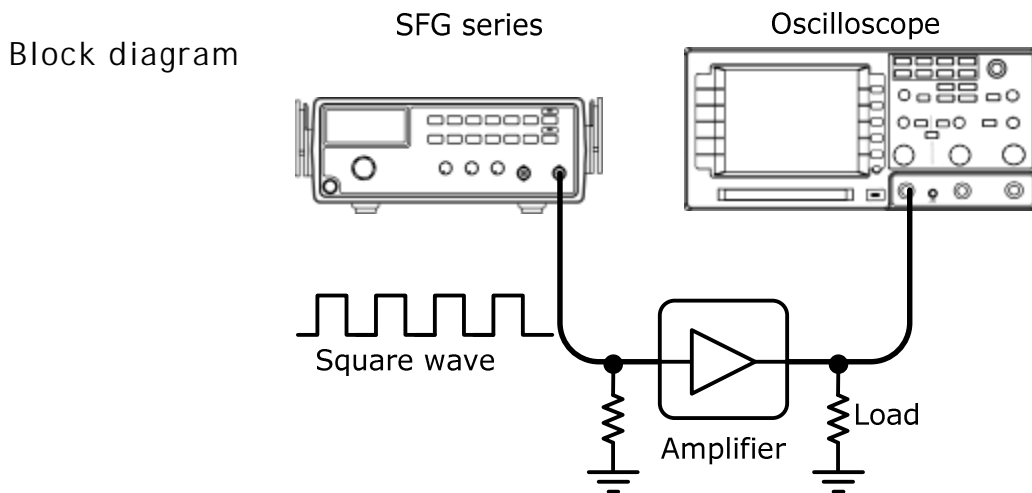



Amplifier Transient Characteristics Test

Description Use the square wave output from SFG-1000 series to check the transient frequency response of an amplifier. The common sine wave is not the ideal source in this case. Observe the waveform using an oscilloscope.

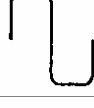

Test step

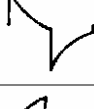
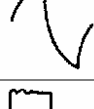
1. Apply a triangle waveform to the amplifier first. Adjust the waveform amplitude to make sure there is no clipping.
2. Switch to square waveform and adjust its frequency to the middle of the amplifier pass band, such as 20Hz, 1kHz, and 10kHz.
3. Observe the shape of the amplifier output. The following table shows the possible output distortions and their explanations.

Transient characteristic list		<ul style="list-style-type: none"> • Amplitude reduction at low frequency • No phase shift
		<ul style="list-style-type: none"> • Low frequency boosted (accentuated fundamental)
		<ul style="list-style-type: none"> • High frequency loss • No phase shift
		<ul style="list-style-type: none"> • Low frequency phase shift • Trace thickened by hum-voltage
		<ul style="list-style-type: none"> • High frequency loss • Phase shift
		<ul style="list-style-type: none"> • Low frequency loss • Phase shift
		<ul style="list-style-type: none"> • Low frequency loss • Low frequency phase shift
		<ul style="list-style-type: none"> • High frequency loss • Low frequency phase shift
		<ul style="list-style-type: none"> • Damped oscillation



Note

For narrow band amplifier testing, square wave may not be suitable.

Logic Circuit Test

Description Use the TTL output from SFG-1000 series to test digital circuits. Observe the timing relation of input/output waveform using an oscilloscope.

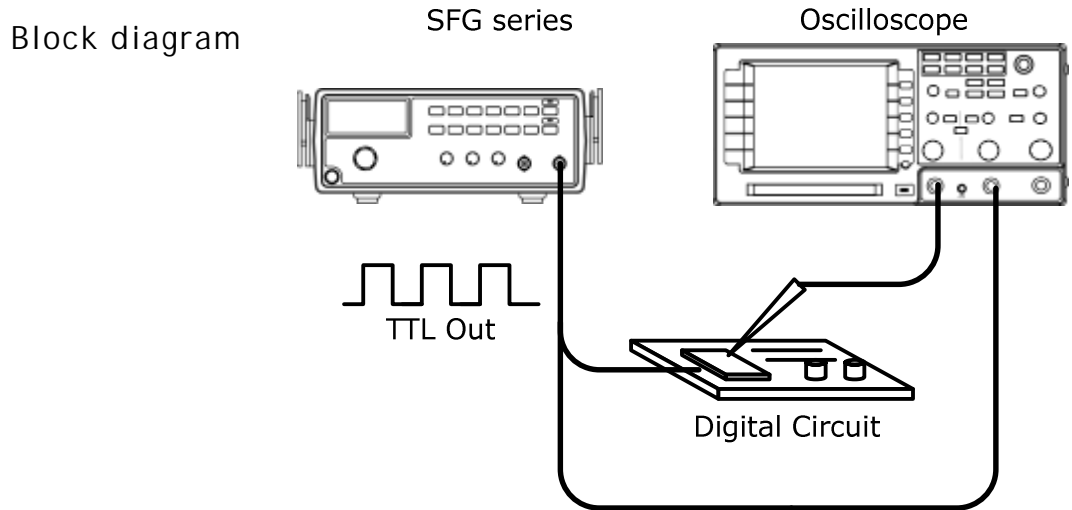

Impedance Matching Network Test

Description Use SFG-1000 series for impedance matching network: testing its frequency characteristic and matching the impedance.

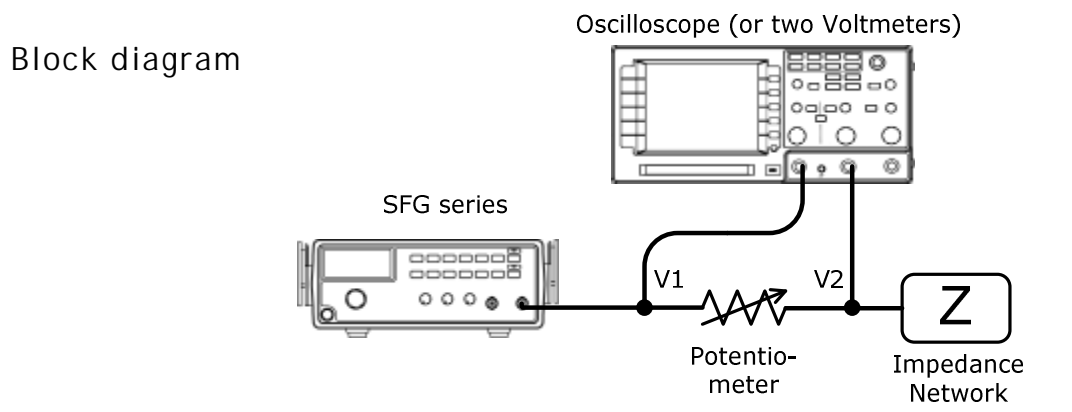

Test step Adjust the potentiometer until V2 becomes the half of V1 ($V2=0.5V1$). Then the impedance Z of the network becomes identical to the potentiometer.

Speaker Driver Test

Description Use SFG-1000 series for testing the frequency characteristics of audio speakers. Record the volt reading versus the input signal frequency.

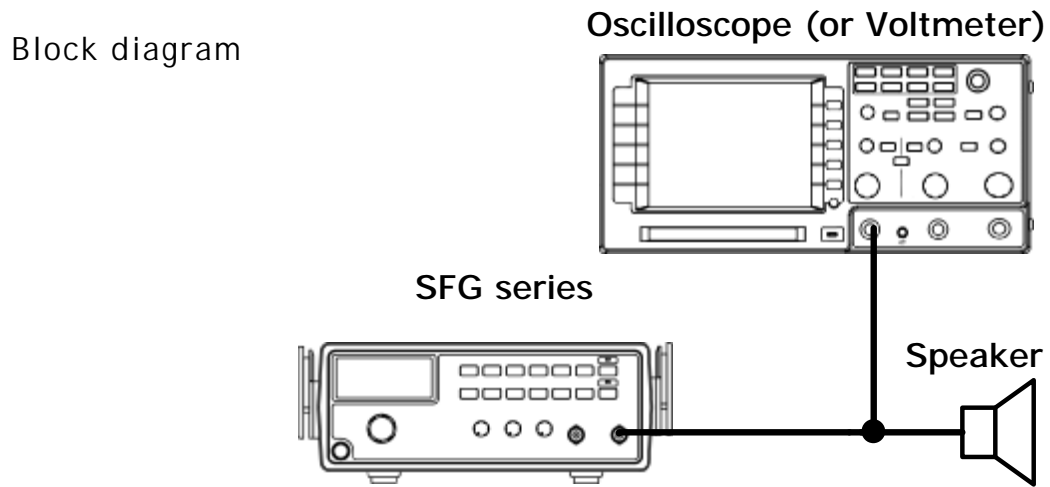

Graph The peak voltage occurs on the resonant frequency of the speaker.

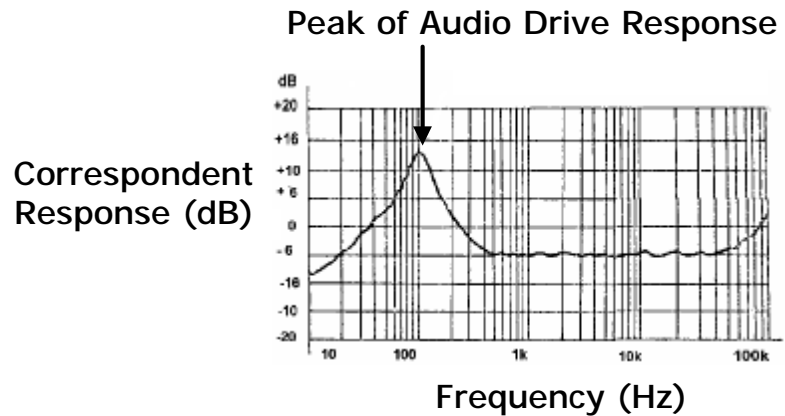

F AQ

- I pressed the Power switch on the front panel but nothing happens.
- How can I get out of TTL/−40dB mode?
- The device accuracy does not match the specification.
- What are these error messages?

I pressed the Power switch on the front panel but nothing happens.

Make sure the AC source voltage is set at the rating $\pm 10\%$, 50/60Hz. For power up sequence, see page17. Otherwise the internal fuse might be blown out. For fuse replacement procedure, see page35.

TTL does not activate (pressed Shift + Wave key)

You need to turn On the output first. Press the Output key, then press Shift+Wave. For details, see page25.

How can I get out of TTL/−40dB mode?

**For TTL: press the Shift key, then the wave key. For details, see page25.
For −40dB mode, press the Shift key, then 3. For details, see page22.**

The device accuracy does not match the specification.

Make sure the device is powered On for at least 30 minutes, within $+18^{\circ}\text{C}\sim+28^{\circ}\text{C}$. This is necessary to stabilize the unit to match the specification.

What are these error messages?

Several messages appear when trying to set the frequency in irregular ways. Page37 summarizes the messages.

If there is still a problem, please contact your local dealer or GWInstek at www.gwinstek.com.tw / marketing@goodwill.com.tw.

APPENDIX

Fuse Replacement

1. Take off the Handle

In order to detach the handle from the unit, turn the handle down 90 degrees, then pull it off sideways.

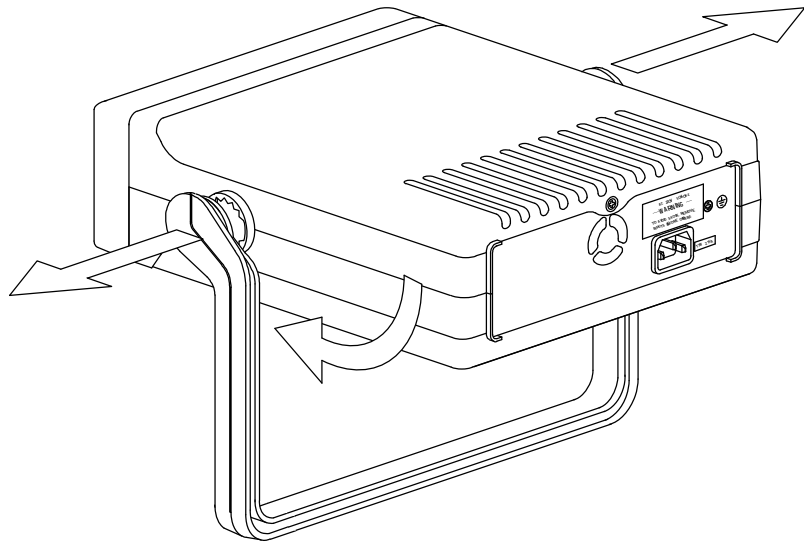

2. Take off the Cover

Take off the two metal holdings from the handle joint. Then take the top screw off from the rear panel.

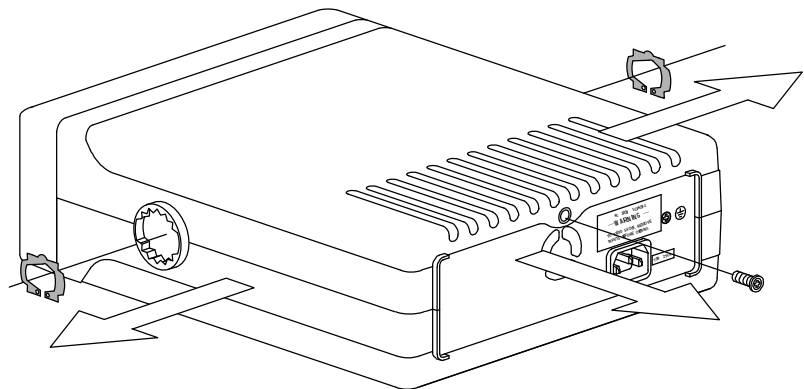

Slide the upper case to the rear side and take off the top cover.

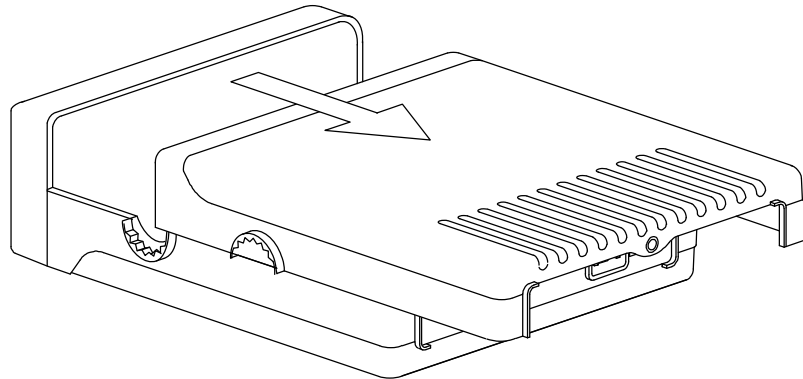

3. Replace the Fuse

Replace the blown fuse located on the rear printed circuit board.

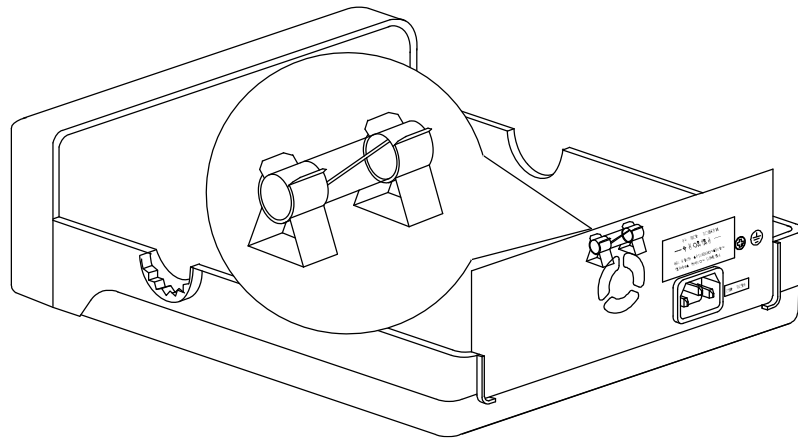

Fuse rating	AC 100/120V	T0.315A/250V
	AC 220/240V	T0.16A/250V

Error Messages

Frequency error	Err-1	Err-2	Err-4
	Sine, square, and TTL wave frequency over range. This message appears when entering sine / square / TTL waveform frequency larger than 3MHz. The frequency is automatically forced to 3MHz.	Triangle wave Frequency over range. This message appears when entering triangle waveform frequency larger than 1MHz. The frequency is automatically forced to 1MHz.	Frequency over resolution. This message appears when trying to enter frequency less than 0.1Hz. The frequency is automatically forced to 0.1 Hz.

Specification

- SFG series must be powered for at least 30 minutes within the ambient temperature 18°C~28°C to meet this spec.

Main	Output Function	Sine, Square, Triangle
	Amplitude Range	10Vpp (50Ω load)
	Amplitude Accuracy	±20% at maximum position (SFG-1013 only)
	Impedance	50Ω ± 10%
	Attenuator	-40dB ± 1dB x1
	DC Offset	< -5V ~ >+5V (50Ω load)
	Duty Range	25% ~ 75%, ≤1MHz (Square Wave)
	Display	6 digits LED display
Frequency	Sine/Square Waveform Range	0.1Hz ~ 3MHz
	Triangle Waveform Range	0.1Hz ~ 1MHz
	Resolution	0.1Hz maximum
	Stability	±20ppm
	Accuracy	±20ppm
	Aging	±5ppm/year

Sine Wave	Harmonic Distortion	$\geq -55\text{dBc}$, 0.1Hz ~ 200kHz $\geq -40\text{dBc}$, 0.2MHz ~ 2MHz $\geq -35\text{dBc}$, 2MHz ~ 3MHz (At maximum position without any attenuation to 1/10 of any combination setting, TTL Off)
	Flatness	$< \pm 0.3\text{dB}$, 0.1Hz ~ 1MHz $< \pm 0.5\text{dB}$, 1MHz ~ 2MHz $< \pm 1\text{dB}$, 2MHz ~ 3MHz (At the max amplitude relating to 1kHz)
Triangle Wave	Linearity	$\geq 98\%$, 0.1Hz ~ 100kHz $\geq 95\%$, 100kHz ~ 1MHz
Square Wave	Symmetry	$\pm 5\%$ of period + 4ns, 0.1Hz ~ 100kHz
	Rise/Fall Time	$\leq 100\text{ns}$ at maximum output, 50Ω load
TTL Output	Level	$\geq 3\text{Vpp}$
	Fan Out	20 TTL Load
	Rise/Fall Time	$\leq 25\text{ns}$
General	Power Source	AC 100/120/220/240V $\pm 10\%$, 50/60Hz (Line voltage setting is factory installed)
	Operation Environment	Indoor Use, Altitude Up to 2000m Ambient Temperature 0 ~ 40°C Relative Humidity $\leq 80\%$, 0 ~ 40°C Install Category II / Pollution Degree 2
	Storage Environment	Temperature -10 ~ 70°C Humidity $\leq 70\%$
	Accessories	Instruction Manual x 1 GTL-101 x 1
	Dimension	251 (W) x 91 (H) x 291 (D)
	Weight	Approx. 2.1kg

Declaration of Conformity

We
GOOD WILL INSTRUMENT CO., LTD.
 (1) No.7-1, Jhongsing Rd., Tucheng City, Taipei County, Taiwan
 (2) No. 69, Lu San Road, Suzhou City (Xin Qu), Jiangsu Sheng, China
 declare, that the below mentioned product
Type of Product: Synthesized Function Generator
Model Number: SFG-1003, SFG-1013
 are herewith confirmed to comply with the requirements set out in the Council Directive on the Approximation of the Law of Member States relating to Electromagnetic Compatibility (89/336/EEC, 92/31/EEC, 93/68/EEC) and Low Voltage Directive (73/23/EEC, 93/68/EEC).
 For the evaluation regarding the Electromagnetic Compatibility and Low Voltage Directive, the following standards were applied:

◎ EMC

EN 61326-1: Electrical equipment for measurement, control and laboratory use — EMC requirements (1997 + A1:1998 + A2:2001 + A3:2003)	
Conducted Emission Radiated Emission EN 55011: Class A 1998 + A1:1999 + A2:2002	Electrostatic Discharge EN 61000-4-2: 1995 + A1:1998 + A2:2001
Current Harmonics EN 61000-3-2: 2000 + A2:2005	Radiated Immunity EN 61000-4-3: 2002 + A1:2002
Voltage Fluctuations EN 61000-3-3: 1995 + A1:2001 + A2:2005	Electrical Fast Transients EN 61000-4-4: 2004
-----	Surge Immunity EN 61000-4-5: 1995 + A1:2001
-----	Conducted Susceptibility EN 61000-4-6: 1996 + A1:2001
-----	Power Frequency Magnetic Field EN 61000-4-8: 1993 + A1:2001
-----	Voltage Dip/ Interruption EN 61000-4-11: 2004

◎ Safety

Low Voltage Equipment Directive 73/23/EEC & amended by 93/68/EEC
Safety Requirements IEC/EN 61010-1: 2001

INDEX

<i>A</i>	
40dB attenuation	
faq	34
step	22
<i>A</i>	
amplifier application example	30
<i>C</i>	
caution symbol	5
cleaning	6
constant current circuit	9
control knob overview	14
<i>D</i>	
default display	17
digital direct synthesis	
block diagram	10
direct digital synthesis	9
display contents overview	12
duty cycle	
faq	34
sine/square/triangle	23
TTL	27
<i>E</i>	
EN55011	39
EN61010	
declaration of conformity	39
measurement category	6
pollution degree	6
error message	
error1	21
error2	21
error4	22
summary	37
<i>F</i>	
FAQ	34
feature list	11
frequency editing	
sine/square/triangle	20
TTL	26
frequency faq	34
front panel key overview	13
fuse	
rating	36
replacement	35
safety instruction	6
<i>G</i>	
ground terminal	
location	15
symbol	5
<i>I</i>	
impedance application example	32
in/out terminal overview	14
<i>L</i>	
logic application example	32
<i>M</i>	
model lineup	11
<i>O</i>	
offset	23
example setting	18
operation environment	
safety instruction	6
specification	38

operation shortcut	18	storage environment	
P		safety instruction	7
peak clip	24	specification	38
PLL example application	28	T	
power supply		table of contents	3
safety instruction	6	tilt stand	16
power up sequence	17	transistor application example	29
faq	34	triangle wave	
R		example setting	18
rear panel overview	15	selection	20
S		troubleshooting example	28
setup step	16	TTL	
sine wave		activation	25
example setting	18	example setting	18
selection	20	U	
speaker application example	33	UK power cord	7
specification	37	V	
FAQ	34	voltage viewing	22
square wave		W	
example setting	18	warning symbol	5
selection	20		