

# Electrical Safety Tester

GPT-9000 / GPT-9000A Series

---

## USER MANUAL

GW INSTEK PART NO. 82PT-90000EE1



ISO-9001 CERTIFIED MANUFACTURER

**GW INSTEK**

This manual contains proprietary information, which is protected by copyright. All rights are reserved. No part of this manual may be photocopied, reproduced or translated to another language without prior written consent of Good Will company.

The information in this manual was correct at the time of printing. However, Good Will continues to improve products and reserves the rights to change specification, equipment, and maintenance procedures at any time without notice.

**Good Will Instrument Co., Ltd.**  
**No. 7-1, Jhongsing Rd., Tucheng Dist., New Taipei City 236, Taiwan.**

# Table of Contents

<b>SAFETY INSTRUCTIONS</b> .....	<b>5</b>
<b>GETTING STARTED</b> .....	<b>9</b>
GPT-9000/9000A Series Overview .....	10
Appearance .....	15
Set Up .....	23
<b>OPERATION</b> .....	<b>30</b>
Menu Tree .....	32
Test Lead Connection .....	36
ACW, DCW, IR and GB Manual Testing .....	38
Special MANU Test Mode (000) .....	76
Automatic Tests .....	81
Common Utility Settings .....	98
<b>EXTERNAL CONTROL</b> .....	<b>105</b>
External Control Overview .....	106
<b>REMOTE CONTROL</b> .....	<b>112</b>
Interface Configuration .....	113
Command Syntax .....	117
Command List .....	120
Error Messages .....	159
<b>FAQ</b> .....	<b>160</b>
<b>APPENDIX</b> .....	<b>162</b>
Fuse Replacement .....	162
Error Messages .....	163
GPT-9000/9000A Specifications .....	166
GPT-9801/9802/9803 Dimensions .....	172

GPT-9804 Dimensions .....	173
GPT-9903 Dimensions .....	174
GPT-9904 Dimensions .....	175
GPT-9901A/9902A/9903A Dimensions	176
Declaration of Conformity .....	177
<b>INDEX.....</b>	<b>178</b>







# S SAFETY INSTRUCTIONS

This chapter contains important safety instructions that you must follow during operation and storage. Read the following before any operation to ensure your safety and to keep the instrument in the best possible condition.

## Safety Symbols

These safety symbols may appear in this manual or on the instrument.

---

	<b>WARNING</b>	Warning: Identifies conditions or practices that could result in injury or loss of life.
	<b>CAUTION</b>	Caution: Identifies conditions or practices that could result in damage to the instrument or to other properties.
	<b>DANGER</b>	High Voltage
	<b>Attention</b>	Refer to the Manual
	<b>Protective Conductor Terminal</b>	
	<b>Frame or Chassis Terminal</b>	
	<b>Earth (ground) Terminal</b>	



Do not dispose electronic equipment as unsorted municipal waste. Please use a separate collection facility or contact the supplier from which this instrument was purchased.

## Safety Guidelines

---

### General Guideline



#### CAUTION

- Do not place any heavy object on the instrument.
- Avoid severe impact or rough handling that leads to damaging the instrument.
- Do not discharge static electricity to the instrument.
- Use only mating connectors, not bare wires, for the terminals.
- Do not block the cooling fan opening.
- Do not disassemble the GPT-9000/GPT-9000A unless you are qualified.

(Measurement categories) EN 61010-1:2010 specifies the measurement categories and their requirements as follows. The GPT-9000/GPT-9000A does not fall under category II, III or IV.

- Measurement category IV is for measurement performed at the source of low-voltage installation.
- Measurement category III is for measurement performed in the building installation.
- Measurement category II is for measurement performed on the circuits directly connected to the low voltage installation.

---

### Power Supply



#### WARNING

- AC Input voltage range:  
100/120/220/230VAC  $\pm 10\%$
  - Frequency: 50Hz/60Hz
  - To avoid electrical shock connect the protective grounding conductor of the AC power cord to an earth ground.
-

Cleaning the  
GPT-9000/  
GPT-9000A

- Disconnect the power cord before cleaning.
- Use a soft cloth dampened in a solution of mild detergent and water. Do not spray any liquid.
- Do not use chemicals containing harsh material such as benzene, toluene, xylene, and acetone.

Operation  
Environment

- Location: Indoor, no direct sunlight, dust free, almost non-conductive pollution (Note below)
- Relative Humidity:  $\leq 70\%$  (no condensation)
- Altitude:  $< 2000\text{m}$
- Temperature:  $0^{\circ}\text{C}\sim 40^{\circ}\text{C}$

(Pollution Degree) EN 61010-1:2010 specifies the pollution degrees and their requirements as follows. The GPT-9000/GPT-9000A falls under degree 2.

Pollution refers to “addition of foreign matter, solid, liquid, or gaseous (ionized gases), that may produce a reduction of dielectric strength or surface resistivity”.

- Pollution degree 1: No pollution or only dry, non-conductive pollution occurs. The pollution has no influence.
- Pollution degree 2: Normally only non-conductive pollution occurs. Occasionally, however, a temporary conductivity caused by condensation must be expected.
- Pollution degree 3: Conductive pollution occurs, or dry, non-conductive pollution occurs which becomes conductive due to condensation which is expected. In such conditions, equipment is normally protected against exposure to direct sunlight, precipitation, and full wind pressure, but neither temperature nor humidity is controlled.

Storage  
environment

- Location: Indoor
- Temperature:  $-10^{\circ}\text{C}$  to  $70^{\circ}\text{C}$
- Relative Humidity:  $\leq 85\%$  (no condensation)

Disposal



Do not dispose this instrument as unsorted municipal waste. Please use a separate collection facility or contact the supplier from which this instrument was purchased. Please make sure discarded electrical waste is properly recycled to reduce environmental impact.

## Power cord for the United Kingdom

When using the safety tester in the United Kingdom, make sure the power cord meets the following safety instructions.

NOTE: This lead/appliance must only be wired by competent persons

 WARNING: THIS APPLIANCE MUST BE EARTHED

IMPORTANT: The wires in this lead are coloured in accordance with the following code:

Green/ Yellow:	Earth
Blue:	Neutral
Brown:	Live (Phase)



As the colours of the wires in main leads may not correspond with the coloured marking identified in your plug/appliance, proceed as follows:

The wire which is coloured Green & Yellow must be connected to the Earth terminal marked with either the letter E, the earth symbol  or coloured Green/Green & Yellow.

The wire which is coloured Blue must be connected to the terminal which is marked with the letter N or coloured Blue or Black.

The wire which is coloured Brown must be connected to the terminal marked with the letter L or P or coloured Brown or Red.

If in doubt, consult the instructions provided with the equipment or contact the supplier.

This cable/appliance should be protected by a suitably rated and approved HBC mains fuse: refer to the rating information on the equipment and/or user instructions for details. As a guide, a cable of 0.75mm<sup>2</sup> should be protected by a 3A or 5A fuse. Larger conductors would normally require 13A types, depending on the connection method used.

Any exposed wiring from a cable, plug or connection that is engaged in a live socket is extremely hazardous. If a cable or plug is deemed hazardous, turn off the mains power and remove the cable, any fuses and fuse assemblies. All hazardous wiring must be immediately destroyed and replaced in accordance to the above standard.



# G E T T I N G   S T A R T E D

This chapter describes the safety tester in a nutshell, including its main features and front / rear panel introduction. After going through the overview, please read the safety considerations in the Set Up chapter.

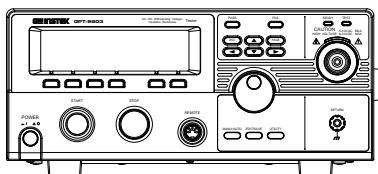

<b>GPT-9000/9000A Series Overview .....</b>	<b>10</b>
Series lineup .....	10
Model Overview .....	11
Main Features .....	11
Accessories .....	12
Package Contents .....	14
<b>Appearance .....</b>	<b>15</b>
GPT-9801/9802/9803/9901A/9902A/9903/9903A Front Panel.....	15
GPT-9804/9904 Front Panel .....	15
GPT-9801/9802/9803/9804 Rear Panels.....	19
GPT-9901A/9902A/9903/9903A Rear Panel.....	19
GPT-9904 Rear Panel .....	20
<b>Set Up.....</b>	<b>23</b>
Line Voltage Connection and Power Up .....	23
Installing the Optional GPIB Card .....	25
Workplace Precautions .....	26
Operating Precautions .....	27
Basic Safety Checks.....	29

## GPT-9000/9000A Series Overview

### Series lineup

The GPT-9000/9000A Series Safety Testers are AC/DC withstanding voltage, insulation resistance and ground bond safety testers.

The GPT-9801/9901A are AC withstanding voltage testers, the GPT-9802/9902A are AC/DC withstanding voltage testers and the GPT-9803/9903/9903A are AC/DC withstanding voltage and insulation resistance testers. The GPT-9804 & GPT-9904 include all the test functions of the other models as well as ground bond testing. All models can operate at up to 5kVAC for AC withstanding voltage testing and at up to 6kVDC for DC withstanding voltage testing (excluding the GPT-9801/9901A).

For the GPT-99XX/99XXA models, the testing terminals are also mirrored on the rear panel for added safety and for more permanent safety testing environments. They also include an innovative sweep function to view test results as a graph.

The GPT-9000/9000A Series can store up to 100 manual tests, as well as run up to 16 manual tests sequentially as an automatic test, allowing the safety testers to accommodate any number of safety standards, including IEC, EN, UL, CSA, GB, JIS and others.

Note: Throughout this user manual, the terms ACW, DCW, IR and GB refer to AC Withstanding, DC Withstanding, Insulation Resistance and Ground Bond testing, respectively. GPT-9000 refers to any of the GPT-98XX or GPT-99XX models, GPT-9000A refers to any of the GPT-99XXA models.

## Model Overview

Model name	ACW	DCW	IR	GB	Sweep
GPT-9801	✓				
GPT-9802	✓	✓			
GPT-9803	✓	✓	✓		
GPT-9804	✓	✓	✓	✓	
GPT-9901A	✓				✓
GPT-9902A	✓	✓			✓
GPT-9903	✓	✓	✓		✓
GPT-9903A	✓	✓	✓		✓
GPT-9904	✓	✓	✓	✓	✓

## Main Features

- Performance
- ACW: 5kVAC
  - DCW: 6kVDC
  - IR: 50V~1000V (50V steps)\*
  - GB: 3A~30A (GPT-98XX);  
3A~32A (GPT-99XX)

\* The GPT-99XX/99XXA also includes an extra +125V test point

- Features
- Ramp up time control
  - Safety discharge
  - 100 test conditions (MANU mode)
  - 100 automatic tests (AUTO mode)
  - Over temperature, voltage and current protection
  - Pass, Fail, Test, High Voltage and Ready indicators
  - PWM output (90% efficiency, increased reliability)
  - Interlock (configurable).
  - Sweep Function.

- Interface
- Remote control start/stop interface terminal
  - RS232/USB interface for programming
  - Optional GPIB interface for programming
  - Signal I/O port for pass/fail/test monitoring and start/stop control/interlock

### Accessories

Standard Accessories	Part number	Description
	GHT-114 x1	Test lead
	Region dependent	Power cord
	GTL-115 x1	GB Test leads (GPT-9804/9904 only)
	N/A	Remote terminal male plug
	N/A	Interlock key
Optional Accessories	Part number	Description
	GHT-205	High Voltage Test Probe

GHT-113	High Voltage Test Pistol
GTL-232	RS232C cable
GTL-248	GPIB cable
GTL-247	USB cable
GRA-417	Rack Adapter Panel (19", 4U) (GPT-9801/9802/9803/ 9804/9901A/9902A/9903A only)

Options	Part number	Description
	Opt.01 GPIB Interface	GPIB module

## Package Contents

Check the contents before using the GPT-9000/GPT-9000A.

---

### Opening the box

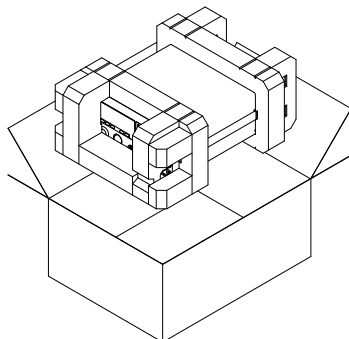

---

#### Contents (single unit)

- GPT-9000/9000A unit
  - Quick Start guide
  - User manual CD
  - CTC (Calibration Traceable Certificate)
  - Power cord x1 (region dependent)
  - GHT-114 test leads x1
  - GTL-115 test leads x1 (GPT-9804/9904)
  - Remote terminal male plug
  - Interlock key
- 

 **Note**

Keep the packaging, including the box, polystyrene foam and plastic envelopes should the need arise to return the unit to GW Instek.

# Appearance





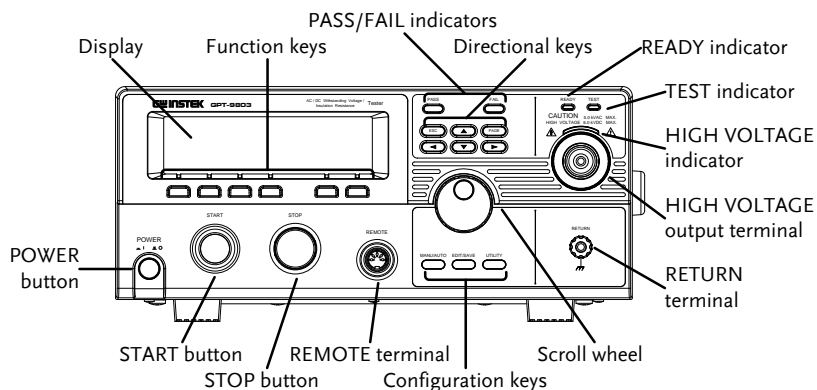

GPT-9801/9802/9803/9901A/9902A/9903/9903A

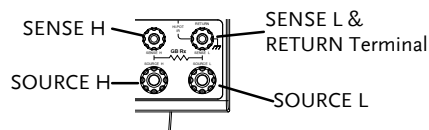
## Front Panel



## GPT-9804/9904 Front Panel

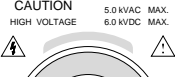

Display	240 X 64 dot matrix display (LCD)	
Function keys	The function keys correspond to the soft-keys directly above on the main display.	
Pass/Fail indicators		The PASS and FAIL indicators light up upon a PASS or FAIL test result at the end of a manual test or automatic test.
ESC key		The ESC key is used to exit out of a menu or cancel a setting.
PAGE key		The PAGE key is used to view automatic test information and test results.
Directional arrow keys		The directional arrow keys are used to navigate menus and parameter settings.
READY indicator		The READY indicator is lit when the tester is ready to begin testing. The STOP button is used to put the tester into READY status.
TEST indicator		The TEST indicator is lit when a test is on. The START button is used to put the tester into TEST status.
HIGH VOLTAGE indicator		The HIGH VOLTAGE indicator will light up when an output terminal is active. Only after the test has finished or stopped will the indicator turn off.



**HIGH VOLTAGE**  
output terminal

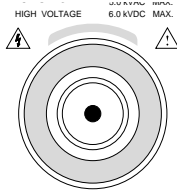

The **HIGH VOLTAGE** terminal output is used for outputting the testing voltage. The terminal is recessed for safety. This terminal is used in conjunction with the **RETURN** terminal.

**! WARNING**

**USE EXTREME CAUTION.**

Do not touch the **HIGH VOLTAGE** terminal during testing.

**RETURN terminal** All models except GPT-9804/9904

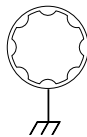

The **RETURN** terminal is used for IR, DCW and ACW tests.

**RETURN, SENSE and SOURCE terminals** GPT-9804/9904

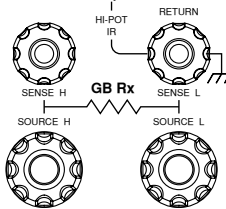

The **RETURN** terminal is used for IR, DCW and ACW tests.

The **SOURCE H**, **SOURCE L**, **SENSE H** and **SENSE L** terminals are used for GB tests.

**Scroll wheel**

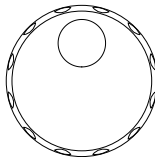

The scroll wheel is used to edit parameter values.

**UTILITY key**



Used to enter the **MANU** Utility or Common Utility menu.

EDIT/SAVE key

EDIT/SAVE



Used to start editing MANU/AUTO tests as well as save settings and parameters.

MANU/AUTO key

MANU/AUTO



The MANU/AUTO key is used to select manual tests (MANU) or automatic tests (AUTO).

REMOTE terminal

REMOTE



The REMOTE terminal is used to connect to a remote controller.

STOP button

STOP

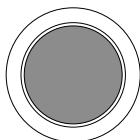

The STOP button is used to stop/cancel tests. The STOP button will also put the safety tester in the READY status to begin testing.

START button

START

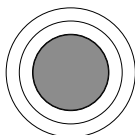

The START button is used to start tests.

The START button can be used to start tests when the tester is in the READY status. Pressing the START button will put the tester in the TEST status.

POWER switch

POWER

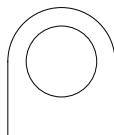

Turns the power on. The safety tester will always start up with the last test setting from when the instrument was last powered down.

### GPT-9801/9802/9803/9804 Rear Panels

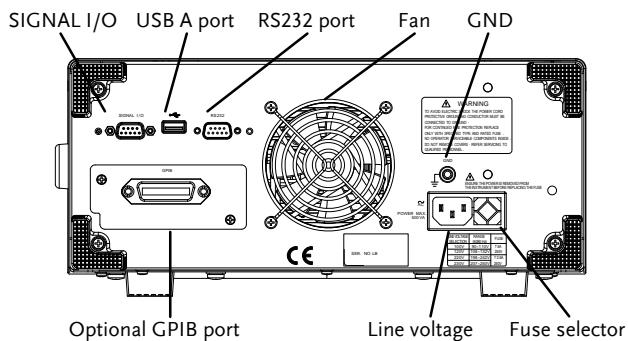

### GPT-9901A/9902A/9903/9903A Rear Panel

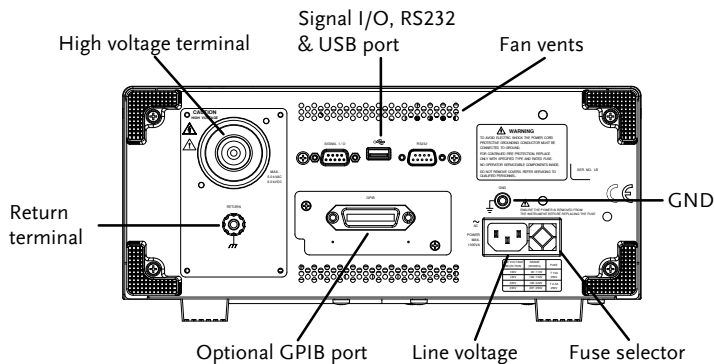

## GPT-9904 Rear Panel

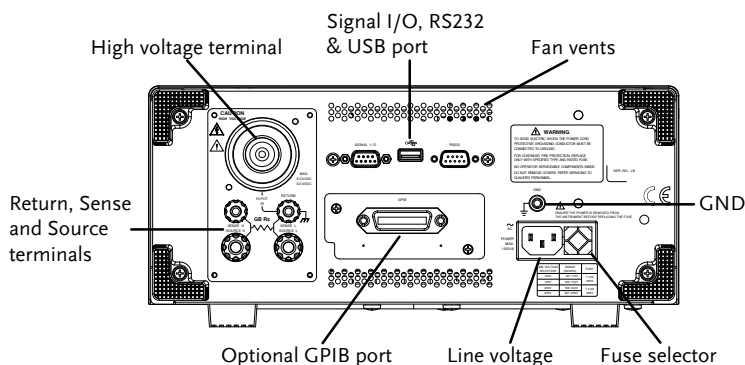

### SIGNAL I/O port

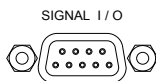

The SIGNAL I/O port is used to monitor the tester status (PASS, FAIL, TEST) and input (START/STOP signals). It is also used with the Interlock key.

### USB A port



Used for remote control.

### RS232 interface port

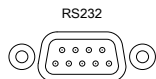

Used for remote control and firmware updates.

### Fan/Fan Vents

Exhaust fan. Allow enough room for the fan to vent. Do not block the fan openings.

### GND

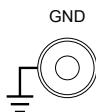

Connect the GND (ground) terminal to the earth ground.

Line voltage input

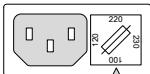

Line voltage input:  
100/120/220/230VAC ±10%

Line voltage fuse

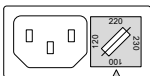

Line voltage selector and fuse:

GPT-98XX:  
100V/120V      T5A 250V  
220V/230V      T2.5A 250V

GPT-99XX/99XXA:  
100V/120V      T10A 250V  
220V/230V      T6.3A 250V

Optional GPIB port



Optional GPIB interface for remote control.

HIGH VOLTAGE output terminal

GPT-99XX /99XXA

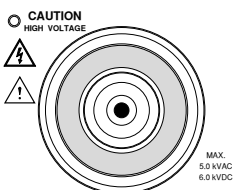

The HIGH VOLTAGE terminal output is used for outputting the testing voltage.

**! WARNING**

USE EXTREME CAUTION.  
Do not touch the HIGH VOLTAGE terminal during testing.

RETURN terminal GPT-9901A/9902A/  
9903/9903A

RETURN

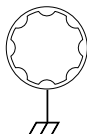

The RETURN terminal is used for IR, DCW and ACW tests.

RETURN/  
SENSE and  
SOURCE  
terminals

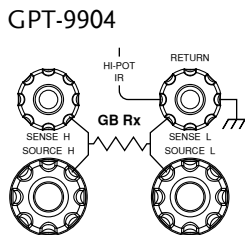

The RETURN terminal is used for IR, DCW and ACW tests.

The SOURCE L/H and SENSE L/H terminals are for GB tests only.

# Set Up

## Line Voltage Connection and Power Up

**Background** Before powering up the GPT-9000/9900A ensure the correct voltage has been selected on the rear panel. The GPT-9000/9000A supports line voltages of 100V/120V/220V and 230V.

- Steps**
1. Check the line voltage and the fuse Page 162 in the fuse holder.

The desired line voltage should line up with the arrow on the fuse holder.

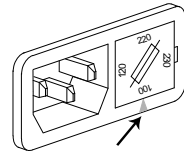

2. Connect the power cord to the AC voltage input.

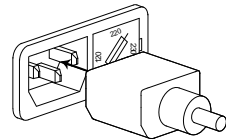

3. If the power cord does not have an earth ground, ensure the ground terminal is connected to an earth ground.

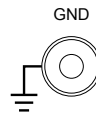

 **Warning**

Ensure the power cord is connected to an earth ground. Failure could be harmful to the operator and instrument.

4. Press the Power button.

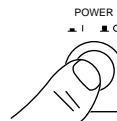

5. When the unit is powering up, all the LED indicators will light. Check to make sure all 5 LED indicators are working.
6. Check to make sure the System Self Test passes without errors.

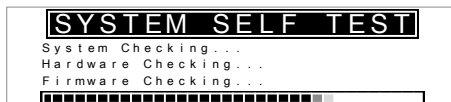

After the System Self Test completes, the tester will go into VIEW status and be ready to operate.

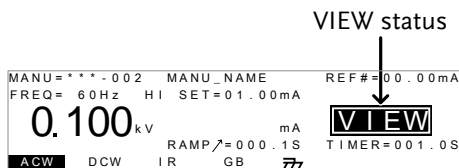

 **WARNING**

See the Appendix on page 163 for details if a self-test error is detected.



## Installing the Optional GPIB Card

---

**Background** The optional GPIB is a user-installable option. Follow the instructions below to install the GPIB card.

---



**WARNING**

Before installing the optional GPIB card ensure the GPT-9000/9000A is turned off and disconnected from power.

---

**Steps**

1. Remove the screws from the rear panel cover plate.

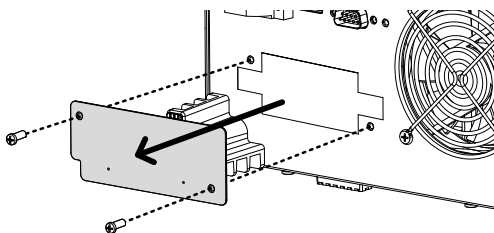

2. Insert the GPIB card into the two slots on either side of the opening. Push the card gently until it is fully inserted.

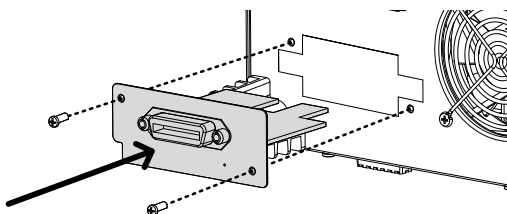

## Workplace Precautions

---

**Background**                      The GPT-9000/9900A is a high voltage instrument that outputs dangerous voltages. The following section describes precautions and procedures that must be followed to ensure a safe work environment.

---



### WARNING

The GPT-9000/9000A generates voltages in excess of 5kVAC or 6kVDC. Follow all safety precautions, warnings and directions given in the following section when using the instrument.

---

1. Only technically qualified personnel should be allowed to operate the safety tester.
2. The operating workplace must be fully isolated, especially when the instrument is in operation. The instrument should be clearly labeled with appropriate warning signage.
3. The operator should not wear any conductive materials, jewelry, badges, or other items, such as wrist watches.
4. The operator should wear insulation gloves for high voltage protection.
5. Ensure the earth ground of the line voltage is properly grounded.
6. Ensure any devices that are adversely affected by magnetic fields are not placed near the tester.

## Operating Precautions

---

**Background**      The GPT-9000/9000A is a high voltage instrument that outputs dangerous voltages. The following section describes precautions and procedures that must be followed to ensure that the tester is operated in a safe manner.

---



### WARNING

The GPT-9000/9000A generates voltages of up to 5kVAC or 6kVDC. Follow all safety precautions, warnings and directions given in the following section when using the instrument.

---

1. Never touch the safety tester, lead wires, terminals, probes and other connected equipment when the tester is testing.
2. Do not turn the safety tester on and off quickly or repeatedly. When turning the power off, please allow a few moments before turning the power back on. This will allow the protection circuits to properly initialize.

Do not turn the power off when a test is running, unless in an emergency.

3. Only use those test leads supplied with the instrument. Leads with inappropriate gauges can be dangerous to both the operator and the instrument.  
For GB testing, never use the Sense leads on the SOURCE terminals.
4. Do not short the HIGH VOLTAGE terminal with ground. Doing so could charge the chassis to dangerously high voltages.

5. Ensure the earth ground of the line voltage is properly grounded.
6. Only connect the test leads to the HIGH VOLTAGE/SOURCE H/SENSE H terminals before the start of a test. Keep the test leads disconnected at all other times.
7. Always press the STOP button when pausing testing.
8. Do not leave the safety tester unattended. Always turn the power off when leaving the testing area.
9. When remotely controlling the safety tester, ensure adequate safety measures are in place to prevent:
  - Inadvertent output of the test voltage.
  - Accidental contact with the instrument during testing. Ensure that the instrument and DUT are fully isolated when the instrument is remotely controlled.
10. Ensure an adequate discharge time for the DUT.

When DCW or IR tests are performed, the DUT, test leads and probes become highly charged. The GPT-9000/9000A has discharge circuitry to discharge the DUT after each test. The time required for a DUT to discharge depends on the DUT and test voltage.

Never disconnect the safety tester before a discharge is completed.

## Basic Safety Checks

---

### Background

The GPT-9000/9000A is a high voltage device and as such, daily safety checks should be made to ensure safe operation.

---

1. Ensure all test leads are not broken and are free from defects such as cracks or splitting.
  2. Ensure the safety tester is always connected to an earth ground.
  3. Test the safety tester operation with a low voltage/current output:  
Ensure the safety tester generates a FAIL judgment when the HIGH VOLTAGE and RETURN terminals are shorted (using the lowest voltage/current as the testing parameters).
- 



### WARNING

Do not use high voltages/currents when the HIGH VOLTAGE and RETURN terminals are shorted. It may result in damage to the instrument.

---

# PERATION

---

<b>Menu Tree</b> .....	<b>32</b>
Menu Tree Overview .....	33
<b>Test Lead Connection</b> .....	<b>36</b>
ACW, DCW, IR Connection .....	36
GB Connection .....	37
<b>ACW, DCW, IR and GB Manual Testing</b> .....	<b>38</b>
Choose/Recall a Manual Test Number .....	39
Edit Manual Test Settings .....	40
Setting the Test Function .....	41
Setting the Test Voltage or Test Current .....	42
Setting the Test Frequency .....	43
Setting the Upper and Lower Limits .....	44
Setting a Reference Value .....	46
Setting the Test Time (Timer) .....	47
Setting the Ramp Up Time .....	50
Creating a MANU Test File Name .....	51
Setting the ARC Mode .....	52
Setting PASS HOLD .....	55
Setting FAIL MODE .....	56
Setting MAX HOLD .....	57
Setting the Grounding Mode .....	58
Saving and Exiting EDIT Status .....	63
Running a MANU Test .....	64
PASS / FAIL MANU Test .....	68
Zeroing of the Test Leads (GB only) .....	73
<b>Special MANU Test Mode (000)</b> .....	<b>76</b>
<b>Automatic Tests</b> .....	<b>81</b>

Choose/Recall an Automatic Test .....	81
Edit Automatic Test Settings.....	83
Adding a Step to the Automatic Test .....	84
Creating an AUTO Test File Name.....	85
Saving and Exiting EDIT Status .....	86
Automatic Test Page View .....	87
Running an Automatic Test .....	90
Automatic Test Results .....	94

## Menu Tree

This section describes the overall structure of the operation statuses and modes for the GPT-9000/9000A safety testers. The testers have two main testing modes (MANU, AUTO) and 5 main operation statuses (VIEW, EDIT, READY, TEST and STOP).

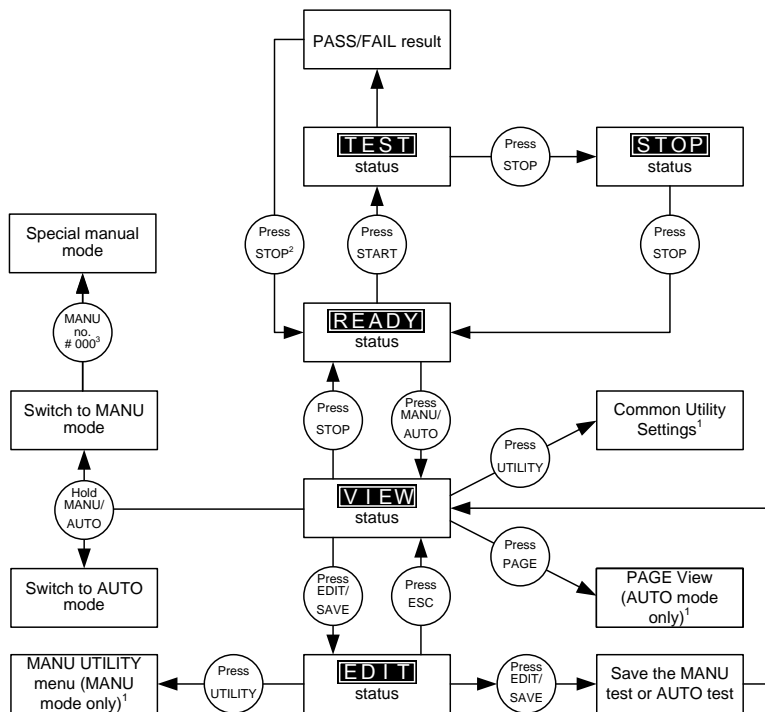

1 Press EDIT/SAVE to save settings, or ESC to cancel and return to the previous screen.

2 Press the STOP key twice for a FAIL result.

3 When in MANU mode, selecting MANU number 000 will enter the special manual mode.

4 The Sweep mode function is only accessible in the special manual mode.



## Menu Tree Overview

### VIEW status

VIEW status is used to view the parameters of the selected manual test/automatic test. The VIEW status is also used to put the tester into MANU or AUTO mode.

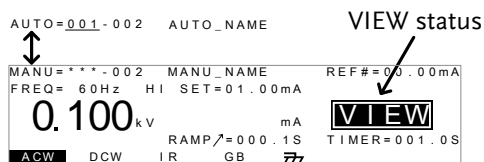

### EDIT status

EDIT status is used to edit the manual test or automatic test parameters. Pressing the EDIT/SAVE key will save any changes. Pressing the ESC key will cancel any changes.

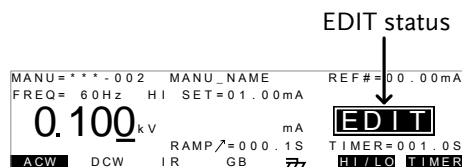

### READY status

When the tester is in READY status, it is ready to begin testing. Pressing the START button will begin testing and put the tester into TEST status. Pressing the MANU/AUTO key will return the tester to VIEW status.

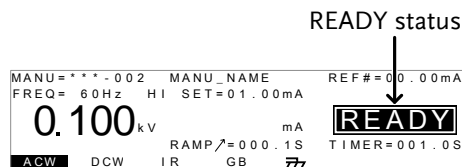

**TEST status**

TEST status is active when a MANU test or AUTO test is running. Pressing STOP will cancel the MANU test or the remaining steps in an AUTO test.

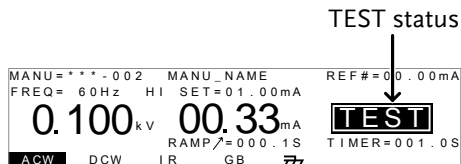

**STOP status**

STOP status is shown when a manual test or automatic test did not finish running and has been stopped by the operator. Pressing STOP will return the tester to READY status.



**Page View**

Up to 16 tests can be used to create an automatic test. Page View is used to see which manual tests (steps) an automatic test is composed of. The steps can be re-arranged and deleted in Page View.

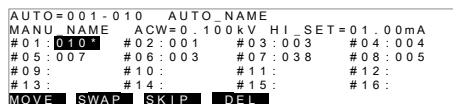

AUTO mode

AUTO indicates that the tester is in AUTO mode. AUTO mode is for creating/running a sequence of up to 16 MANU tests.

AUTO mode

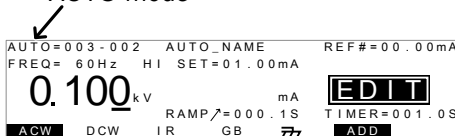

MANU mode

MANU mode is used to create and/or execute a single test. MANU indicates that the manual test mode is active.

MANU mode

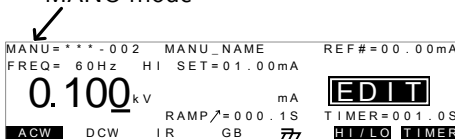

Common Utility Settings

This utility controls the LCD, buzzer, interface and control settings. These settings are system wide.

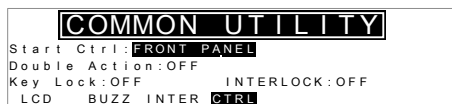

MANU Utility Settings

The Manu Utility settings are configured for each MANU test separately. The settings include: ARC MODE, PASS HOLD, FAIL MODE, MAX HOLD and GROUND MODE.

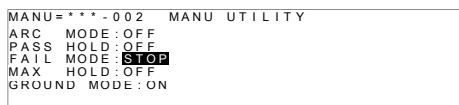

## Test Lead Connection

This section describes how to connect the GPT-9000/GPT-9000A to a DUT for withstanding, insulation resistance or ground bond testing.

### ACW, DCW, IR Connection

---

#### Background

ACW, DCW and IR tests use the HIGH VOLTAGE terminal and RETURN terminal with the GHT-114 test leads.

#### ACW, DCW, IR Connection

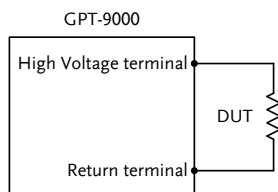

#### Steps

1. Turn the power off on the safety tester.
2. Connect the high voltage test lead (red) to the HIGH VOLTAGE terminal and screw firmly into place.
3. Connect the return test lead (white) into the RETURN terminal and screw the protector bar into place, as shown below.

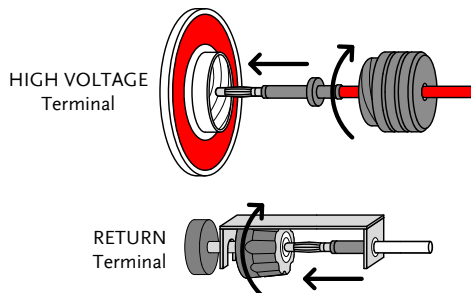

## GB Connection

### Background

GB tests use the SENSE H/L and SOURCE H/L terminals with the GTL-115 test leads.

### GB Connection

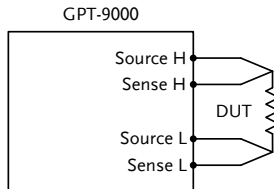

### Steps

1. Turn the power off on the safety tester.
2. Connect the Sense H lead to the SENSE H terminal.
3. Connect the Sense L lead to the SENSE L terminal.
4. Connect the Source H lead to the SOURCE H terminal.
5. Connect the Source L lead to the SOURCE L terminal.

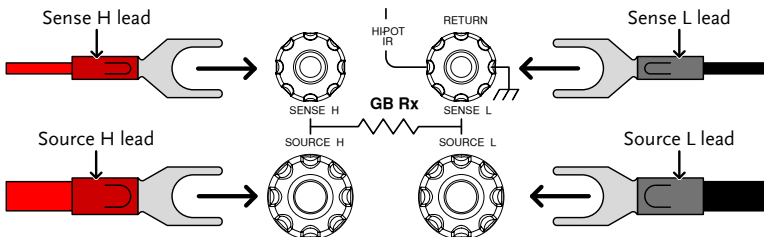

## ACW, DCW, IR and GB Manual Testing

This section describes how to create, edit and run a *single* ACW, DCW, IR or GB safety test. Each Manual setting described in this chapter *only applies to the selected manual test – no other manual tests are affected.*

Each manual test can be stored/recalled to/from one of 100 memory locations. Each stored manual test can be used as a test step when creating an AUTO test (page 81).

- Choose/Recall a Manual Test number → from page 39.
- Edit Manual Test Settings → from page 40.
- Setting the Test Function → from page 41.
- Setting the Test Voltage or Test Current → from page 42.
- Setting the Test Frequency → from page 43.
- Setting the Upper and Lower Limits → from page 44.
- Setting a Reference Value → from page 46.
- Setting the Test Time (Timer) → from page 47.
- Setting the Ramp Up Time → from page 50.
- Creating a MANU Test File Name → from page 51.
- Setting the ARC Mode → from page 52.
- Setting PASS HOLD → from page 55.
- Setting FAIL MODE → from page 56.
- Setting MAX HOLD → from page 57.
- Setting the Grounding Mode → from page 58.
- Saving and Exiting EDIT Status → from page 63.
- Running a MANU Test → from page 64.
- PASS / FAIL MANU Test → from page 68.
- Zeroing of the Test Leads (GB only) → from page 73
- Special MANU Test Mode (000) → from page 76

Before operating the GPT-9000/9000A please read the safety precautions as outlined in the Set Up chapter on page 23.

## Choose/Recall a Manual Test Number

**Background**

ACW, DCW, IR and GB tests can only be created in the MANU (manual) mode. MANU number 001 to 100 can be saved and thus be loaded when editing/creating a MANU test or AUTO test. MANU number 000 is a special mode. See page 73 for details on the special mode.

**Steps**

1. If the tester is in AUTO mode, press and hold the MANU/AUTO key for three seconds to switch to MANU mode.

MANU/AUTO



The tester can only switch between AUTO and MANU mode when in the VIEW status.

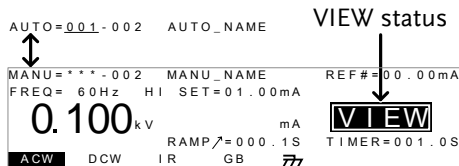

2. Use the scroll wheel to choose the MANU number.

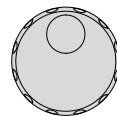

MANU # 001~100  
(MANU# 000 is a special mode)

MANU number

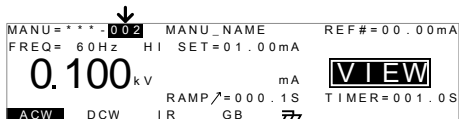



Note

The MANU number can only be chosen in VIEW status. If in the EDIT status, switch to the VIEW status by pressing the EDIT/SAVE or ESC key.

## Edit Manual Test Settings

---

Background

To edit any of the manual test settings, the tester must be in EDIT status.

Any settings or parameters that are edited only apply to the currently selected MANU number.

Steps

1. Press the EDIT/SAVE key when in VIEW status to enter the EDIT status. This will enter the EDIT status for the chosen test number. 

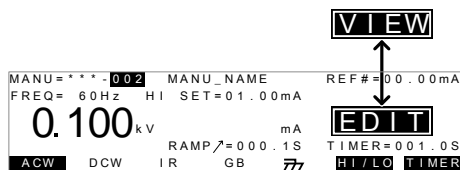

2. The Status changes from VIEW to EDIT.



Note

Pressing the EDIT/SAVE key again will save the settings for the current test and return back to VIEW status.



## Setting the Test Function

**Background** After a MANU number has been chosen and the tester is in EDIT status, a test function can be set.

There are four test functions, AC Withstand, DC Withstand, Insulation Resistance and Ground Bond.

- Steps**
1. To choose the test function, press the ACW, DCW, IR or GB soft-keys.



2. The test function soft-key is highlighted.

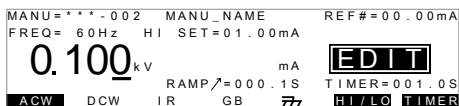

test function





The chosen test function only applies to the current test.

## Setting the Test Voltage or Test Current

**Background** The test voltage can be set from 0.100kV to 5kV for ACW, 0.100kV to 6kV for DCW and 0.050 to 1kV for IR (50V steps\*). For GB tests the test current can be set from 3A to 30A (GPT-98XX) or 3A to 32A (GPT-99XX).  
 \*GPT-99XX/GPT-99XXA includes a 125V test point.

**Steps**

1. Press the UP / DOWN arrow keys to bring the cursor to the voltage setting.  

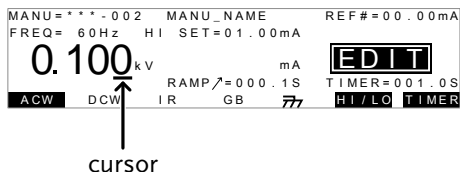

2. Use the scroll wheel to set the voltage level.

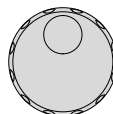

ACW	0.100kV ~ 5kV
DCW	0.100kV ~ 6kV
IR	0.05kV ~ 1kV (50V steps)*
GB	3.00A ~ 33.00A (GPT-98XX) 3.00A ~ 33.00A (GPT-99XX)

\*GPT-99XX/99XXA includes a 125V test point.

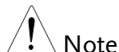

Note

When setting the voltage, be aware that a maximum of 200VA can be set for ACW and 50W for DCW (GPT-98XX) or 500VA and 100W, respectively for GPT-99XX/99XXA.

The ground bond voltage (GBV) is calculated as the HI SET limit x Test Current.

## Setting the Test Frequency

### Background

A test frequency of 60Hz or 50Hz can be set, regardless of the input line voltage. The test frequency setting only applies to ACW and GB tests.

### Steps

1. Press the UP / DOWN arrow keys to bring the cursor to the **FREQ** setting.

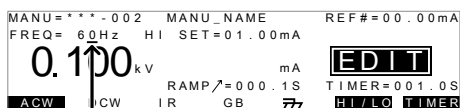

cursor

2. Use the scroll wheel to set the test frequency.

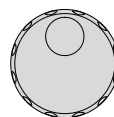

ACW, GB 50Hz, 60Hz



Note

The test frequency can only be set for ACW or GB tests.

## Setting the Upper and Lower Limits

### Background

There is both a LO and HI judgment setting. When the measured value is below the LO SET setting, the test will be judged as FAIL. When the value exceeds the HI SET setting the test will be judged as FAIL. Any measurement between the LO SET and HI SET setting is judged as PASS. The LO SET limit cannot be made greater than the HI SET limit.

### Steps

1. Press the HI/LO soft-key or use the UP / DOWN arrow keys to bring the cursor to the HI SET (ACW/DCW/GB) setting or the LO SET(IR) setting.

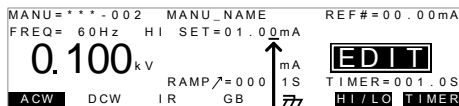
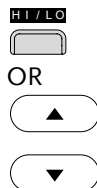

2. Use the scroll wheel to set the HI SET/LO SET limit.

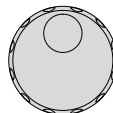

- ACW (HI) 0.001mA~042.0mA (GPT-98XX)  
0.001mA~110.0mA (GPT-99XX/  
99XXA)
- DCW (HI) 0.001mA~011.0mA (GPT-98XX)  
0.001mA~021.0mA (GPT-99XX/  
99XXA)
- IR (LO) 0001MΩ ~ 9999MΩ (GPT-98XX)  
0.001GΩ ~ 50.00GΩ (GPT-99XX/  
99XXA)
- GB (HI) 000.1mΩ ~ 650.0mΩ

3. Press the HI/LO soft-key again or press the DOWN arrow key to switch between HI SET and LO SET.

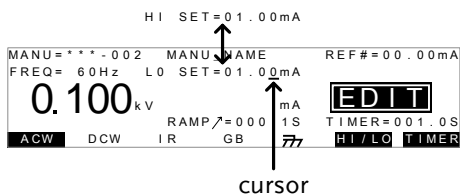
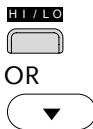

4. Use the scroll wheel to set the HI SET/LO SET limit.

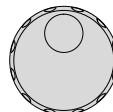

- ACW (LO) 0.000mA~041.9mA (GPT-98XX)  
0.000mA~109.9mA (GPT-99XX/99XXA)
- DCW (LO) 0.000mA~010.9mA (GPT-98XX)  
0.000mA~020.9mA (GPT-99XX/99XXA)
- IR (HI) 0001MΩ~9999MΩ, ∞ (GPT-98XX)  
0.001GΩ~50.00GΩ, ∞ (GPT-99XX/99XXA)
- GB (LO) 000.0mΩ ~ 649.9mΩ





The LO SET setting is limited by the HI SET setting. The LO SET limit cannot be greater than the HI SET limit.

When setting the current, be aware that a maximum of 200VA can be set for ACW and 50W for DCW (GPT-98XX) or 500VA and 100W, respectively for GPT-99XX/99XXA.

## Setting a Reference Value

**Background** The REF# acts as an offset. The REF# value is subtracted from the measured current (ACW, DCW) or measured resistance (IR, GB).

- Steps**
1. Press the UP / DOWN arrow keys  to bring the cursor to the REF# setting. 

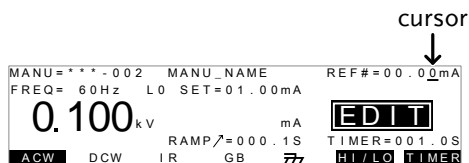

2. Use the scroll wheel to set the REF# value.

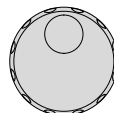

ACW	0.000mA~HI SET current-0.1mA
DCW	0.000mA~HI SET current-0.1mA
IR	0000MΩ~HI SETΩ-1MΩ
GB	000.0mΩ~HI SETΩ-0.1mΩ



For GB tests, a reference offset can be automatically created using the zeroing function. See page 73 for details.

## Setting the Test Time (Timer)

### Background

The TIMER setting is used to set the test time for the current test. The test time determines how long the test voltage or current is applied to the DUT. This test time does not include Ramp  $\uparrow$ , initial start time or discharge time (note: GB does not have Ramp  $\uparrow$  or discharge times). The test time can be set from 0.5 seconds to 999.9 seconds for ACW, DCW and GB and 1.0 second to 999.9 seconds for IR, with a resolution of 0.1 seconds for all modes. The timer can be turned off when in the special MANU test mode when using the ACW or DCW test functions.

Each test has an initial test time of 100ms and a discharge time (except GB). The total discharge time depends on the DUT and test voltage.

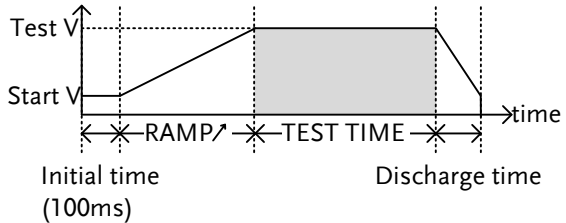

### Steps

1. Press the TIMER soft-key or use the UP/DOWN arrow keys to bring the cursor to the TIMER setting.

**TIMER**



OR



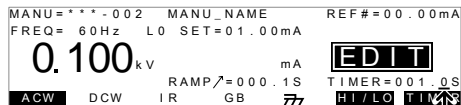

cursor

2. Use the scroll wheel to set the TIMER value.

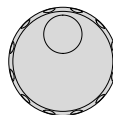

ACW	000.5s~999.9s
DCW	000.5s~999.9s
IR	001.0s~999.9s
GB	000.5s~999.9s



Note

With the ACW test function, when the test current is between 30mA and 40mA (GPT-98XX) or 80mA and 100mA (GPT-99XX/99XXA), the ramp time + test time cannot exceed 240 seconds. At this current level, the tester also needs to pause after a test for a time equal to or greater than the output time. See the specifications on page 166 for details.

Special Manual Mode

When in special MANU test mode (page 73) the Timer can be turned off when using the DCW or ACW test function.

Hold the TIMER soft-key for 3 seconds to turn the timer off.







Note

The timer can only be turned off under special MANU test mode, however there is a limitation: The timer cannot be turned off (limited to 240s) if the test current is between 30mA and 40mA (GPT-98XX) or 80mA and 100mA (GPT-99XX/99XXA) in ACW mode.

The discharge time and initial test time cannot be edited.

## Setting the Ramp Up Time

### Background

The Ramp Up time is the total time taken for the tester to reach the test voltage level. The Ramp Up time starts after the initial time (100ms) with a start voltage of 50 volts. The Ramp Up time can be set from 000.1 to 999.9 seconds. The Ramp Up time is only applicable for ACW, DCW and IR tests.

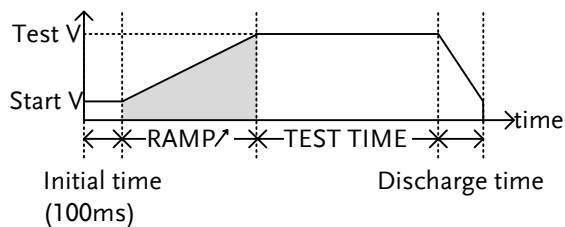

### Steps

1. Use the UP/DOWN arrow keys to bring the cursor to the RAMP ↗ setting.

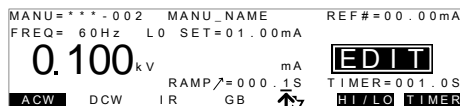
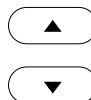

cursor

2. Use the scroll wheel to set the RAMP ↗ value.

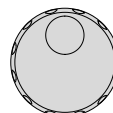

ACW	000.1s~999.9s
DCW	000.1s~999.9s
IR	000.1s~999.9s



Note



The discharge time and initial test time cannot be edited.

## Creating a MANU Test File Name



**Background** Each manual test can have a user-defined test file name (default: MANU\_NAME) up to 10 characters long. See the character list below for the allowed characters.

### Character List

0	1	2	3	4	5	6	7	8	9																
A	B	C	D	E	F	G	H	I	J	K	L	M	N	O	P	Q	R	S	T	U	V	W	X	Y	Z
a	b	c	d	e	f	g	h	i	j	k	l	m	n	o	p	q	r	s	t	u	v	w	x	y	z
+	-	*	/	_	=	:	Ω	?	(	)	<	>	[	]											

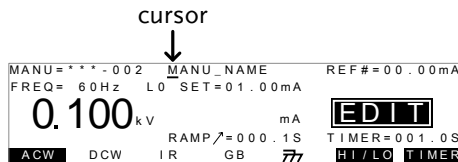
- Steps**
1. Use the UP/DOWN arrow keys to bring the cursor to the MANU test file name at the top of the screen. The test file name is initially set as MANU\_NAME.  

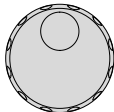

2. Use the scroll wheel to scroll through the available characters. 
3. Press the Left/Right arrow keys to go the next character.  
4. The MANU test file name is set when the current test setting is saved or when the cursor is moved to another setting.

## Setting the ARC Mode

**Background**                      ARC detection, otherwise known as flashover detection, detects fast voltage or current transients that are not normally detected. Arcing is usually an indicator of poor withstanding insulation, electrode gaps or other insulating problems that cause temporary spikes in current or voltage during ACW and DCW testing.

There are three ARC detection settings: OFF, ON AND CONTINUE, ON AND STOP. The ON AND CONTINUE setting will detect arcs over the ARC current level and continue the test, the ON AND STOP setting will stop the test when an arc is detected.

ARC mode settings only apply to ACW and DCW tests.

- Steps**                              1. Press the UTILITY key on the front panel when the tester is in EDIT status. The tester will go to the MANU Utility for the *current test*.



```
MANU=***-002  MANU UTILITY
ARC  MODE: OFF
PASS HOLD: OFF
FAIL MODE: STOP
MAX  HOLD: OFF
GROUND MODE: ON
```



**Note**

The MANU UTILITY settings only apply to the selected MANU test.

2. Use the UP/DOWN arrow keys to move to the ARC MODE setting.



3. Use the scroll wheel to set the ARC mode.

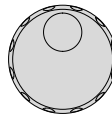

ARC MODES: OFF, ON AND CONTINUE,  
ON AND STOP

4. Press the EDIT/SAVE key to save and exit the MANU Utility and go back to EDIT status.



Note

The ESC key can be pressed at any time in the Utility menu to cancel and exit.

5. If the ARC MODE was set to either ON AND CONTINUE, or ON AND STOP, the ARC current level can be edited.

6. Use the UP/DOWN arrow keys to move the cursor to the ARC setting.



7. Use the scroll wheel to edit the ARC level.

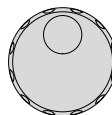

GPT-98XX:

ACW	1.000mA~080.0mA
DCW	1.000mA~020.0mA

GPT-99XX/99XXA:

ACW	2.000mA~200.0mA
DCW	2.000mA~040.0mA



Note

The ARC setting range is directly related to the HI SET current limit.

ACW: GPT-98XX

HI SET Limit	ARC Range
0.001mA~0.999mA	1.000mA ~2.000mA
01.00mA~09.99mA	01.00mA ~20.00mA
010.0mA~042.0mA	001.0mA ~080.0mA

ACW: GPT-99XX/99XXA

HI SET Limit	ARC Range
0.001mA~1.100mA	2.000mA
01.11mA~11.00mA	02.00mA ~20.00mA
011.1mA~110.0mA	002.0mA ~200.0mA

DCW: GPT-98XX

HI SET Limit	ARC Range
0.001mA~0.999mA	1.000mA ~2.000mA
01.00mA~09.99mA	01.00mA ~20.00mA
010.0mA~011.0mA	001.0mA ~020.0mA

DCW: GPT-99XX/99XXA

HI SET Limit	ARC Range
0.001mA~1.100mA	2.000mA
01.11mA~11.00mA	02.00mA ~20.00mA
011.1mA~021.0mA	002.0mA ~040.0mA

## Setting PASS HOLD

---

**Background**                      The PASS HOLD settings only apply to the selected test in an AUTO test. When the PASS HOLD setting is set to ON, a PASS judgment is held until the START button is pressed.

---

 **Note**                              The PASS HOLD setting only applies to AUTO tests. This setting is ignored when running a *single* MANU test.

---

**Steps**                              1. Press the UTILITY key on the front panel when the tester is in EDIT status. The display will go from the normal EDIT status to the MANU Utility menu for *the current test*.



```
MANU=***-002  MANU UTILITY
ARC  MODE: OFF
PASS HOLD: OFF
FAIL MODE: STOP
MAX  HOLD: OFF
GROUND MODE: ON
```

 **Note**                              The MANU UTILITY settings only apply to the selected MANU test.

---

2. Use the UP/DOWN arrow keys to move to the PASS HOLD setting.



3. Use the scroll wheel to set PASS HOLD.

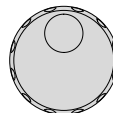

PASS HOLD OFF, ON

4. Press the EDIT/SAVE key to save and exit the MANU Utility menu.





Note

The ESC key can be pressed at any time in the MANU Utility menu to cancel and exit.

## Setting FAIL MODE

### Background

The FAIL MODE settings only apply to the selected test in AUTO tests. FAIL MODE has three options, CONTINUE, HOLD and STOP.

When FAIL MODE is set to CONTINUE the tester will continue testing after a FAIL judgment.

When set to HOLD, the tester will hold the test on a FAIL judgment, and then continue testing after the START key is pressed.

The STOP mode will completely stop the test after a FAIL judgment.



Note

The FAIL MODE setting only applies to AUTO tests. This setting is ignored when running MANU tests.

### Steps

1. Press the UTILITY key on the front panel when the tester is in MANU/EDIT status. The display will go from the normal EDIT status to the MANU Utility menu for the current test.



```
MANU=*** - 002  MANU UTILITY
ARC  MODE : OFF
PASS HOLD : OFF
FAIL MODE : STOP
MAX  HOLD : OFF
GROUND MODE : ON
```



2. Use the UP/DOWN arrow keys to move to the FAIL MODE setting.



3. Use the scroll wheel to set FAIL MODE.

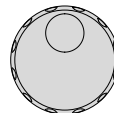

FAIL MODE CONTINUE, HOLD, STOP

4. Press the EDIT/SAVE key to save and exit the MANU Utility menu.

EDIT/SAVE



Note

The ESC key can be pressed at any time in the MANU Utility menu to cancel and exit.

## Setting MAX HOLD

Background

The MAX HOLD setting will hold the maximum current measured in the ACW and DCW tests or the maximum resistance measured in IR and GB tests.

Steps

1. Press the UTILITY key on the front panel when the tester is in EDIT status. The display will go from the normal EDIT status to the MANU Utility menu for *the current test*.

UTILITY



```

MANU=***-002  MANU UTILITY
ARC  MODE:OFF
PASS HOLD:OFF
FAIL MODE:STOP
MAX  HOLD:0.00
GROUND MODE:ON
    
```



Note

The MANU UTILITY settings only apply to the selected MANU test.

2. Use the UP/DOWN arrow keys to move to the MAX HOLD setting.



3. Use the scroll wheel to set MAX HOLD.

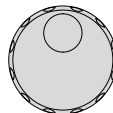

MAX HOLD OFF, ON

4. Press the EDIT/SAVE key to save and exit the MANU Utility menu.

EDIT/SAVE



Note

The ESC key can be pressed at any time in the MANU Utility menu to cancel and exit.

## Setting the Grounding Mode

### Background

When GROUND MODE is set to ON, the GPT-9000/9000A grounds the return terminal to the ground. This mode is best for DUTs that are grounded to an earth ground by their chassis, fixtures or operation environment. This mode measures the potential of the HIGH VOLTAGE terminal with respect to earth ground. This means that any stray capacitance/resistance that leaks to earth ground will also be measured. This is the safest testing mode, though potentially not as accurate.

When GROUND MODE is set to OFF, the return terminal is floating with respect to the earth ground. This mode is for DUTs that are floating and not directly connected to an earth ground. This is more accurate than when GROUND MODE is set to ON as any stray capacitance/resistance that leaks to the earth

ground from the DUT side of the testing circuit will not be measured. For this reason, this testing mode is able to measure to a higher resolution.

The GROUND MODE is always set to OFF for IR and GB tests.

GROUND MODE = ON, DUT grounded

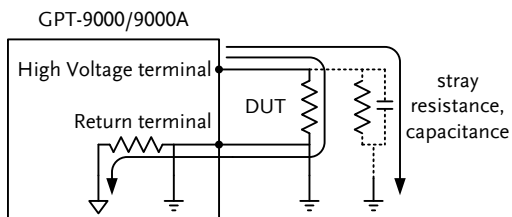

GROUND MODE = ON, DUT floating

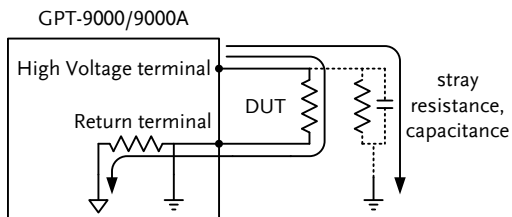

**GROUND MODE = OFF, DUT floating**

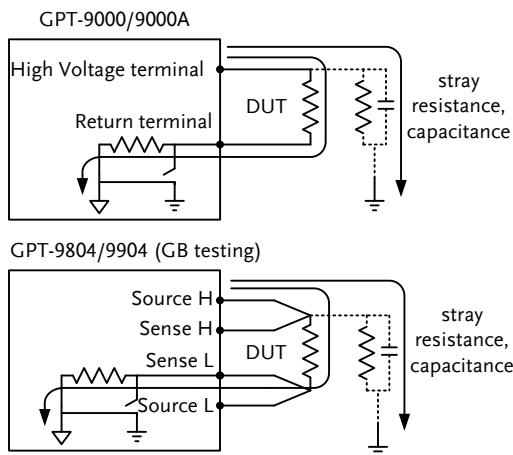

**GROUND MODE = OFF, DUT grounded**

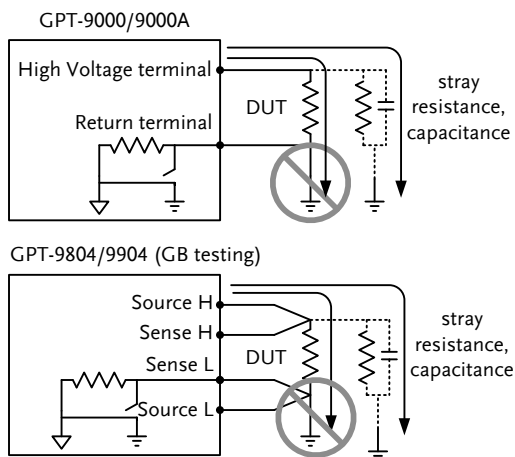



Warning

When GROUND MODE is set to OFF, the DUT, fixtures or connected instrumentation cannot be grounded. This will short circuit the internal circuitry during a test.

For ACW and DCW tests, if it is not known whether the DUT test setup is grounded or not, always set GROUND MODE to ON.

Only set GROUND MODE to OFF when the DUT is floating electrically.

Steps

1. Press the UTILITY key on the front panel when the tester is in EDIT status. The display will go from the normal EDIT status to the MANU Utility menu for *the current test*.



```
MANU=***-002  MANU UTILITY
ARC  MODE:OFF
PASS HOLD:OFF
FAIL MODE:STOP
MAX  HOLD:OFF
GROUND MODE:ON
```



Note

The MANU UTILITY settings only apply to the selected MANU test.

2. Use the UP/DOWN arrow keys to move the cursor to the GROUND MODE setting.



3. Use the scroll wheel to set the GROUND MODE.

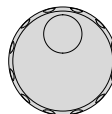

GROUND MODE OFF, ON

4. Press the EDIT/SAVE key to save and exit the MANU Utility menu.



- The GROUND MODE icon on the display changes accordingly.

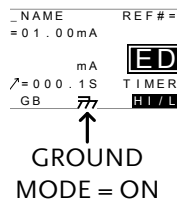
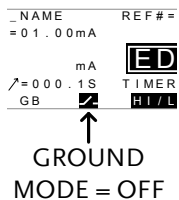

Note

The ESC key can be pressed at any time in the MANU Utility menu to cancel and exit.

IR and GB tests can only have GROUND MODE set to OFF.

## Saving and Exiting EDIT Status

**Background** After all test parameters have been set, the test can be saved. After a test is saved it can be used when creating an AUTO test.

 **Warning** The special MANU number, 000, can be saved, however it cannot be used for AUTO tests. See page 73 for details.

- Steps**
1. When in EDIT status, press the EDIT/SAVE key to save the current test. This will enter the VIEW status for the chosen test number.

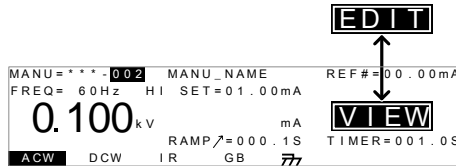

2. The Status changes from EDIT to VIEW.

 **Note** Pressing the EDIT/SAVE key again will return the tester back to EDIT status for the current test.

## Running a MANU Test

**Background**                      A test can be run when the tester is in READY status.



The tester cannot start to run a test under the following conditions:

- A protection setting has been tripped; when a protection setting has been tripped the corresponding error message is displayed on the screen. See page 164 for a comprehensive list of the all the setting errors.
- The INTERLOCK function is ON and the Interlock key is not inserted in the signal I/O port (page 102).
- The STOP signal has been received remotely.

If Double Action is ON, ensure the START button is pressed immediately after the STOP button (<0.5s).



When a test is running the voltage output cannot be changed, unless the test is under the special manual mode. See page 73 for details.

**Steps**                              1. Ensure the tester is in VIEW status Page 63 for the current test. Save the current test if necessary.

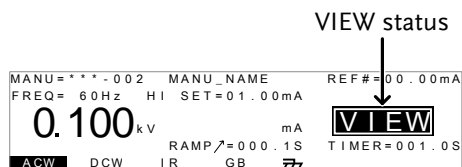



2. Press the STOP button to put the tester into the READY status.

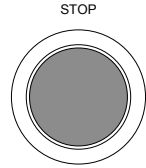

READY status

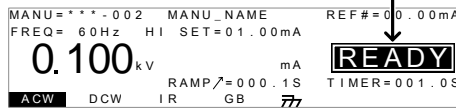

3. The READY indicator will be lit blue when in the READY status.



4. Press the START button when the tester is in the READY status. The manual test starts automatically and the tester goes into the TEST status.

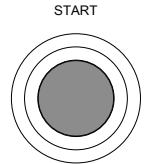

5. The TEST indicator will be lit orange when in the TEST status.



TEST status

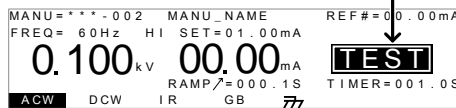

6. The test will start by showing the remaining ramp up time, followed by the remaining test time. The test will continue until the test is finished or the test is stopped.

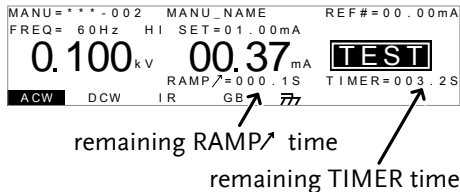

ACW Example

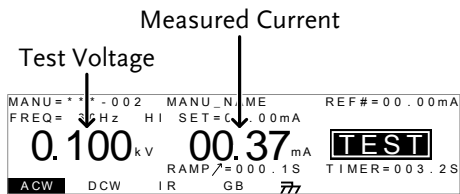

DCW Example

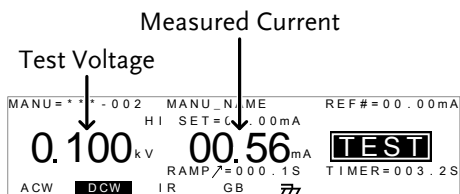

IR Example

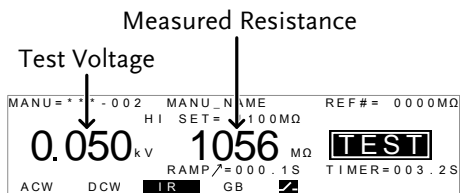

GB Example

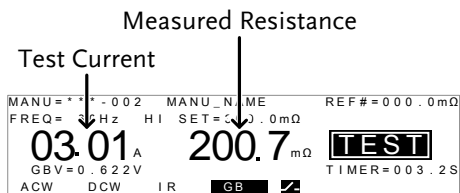

Stop the Test

1. To stop the test at any time when it is running, press the STOP button. The test will stop immediately. When the STOP button is pressed, a judgment is not made on the test.

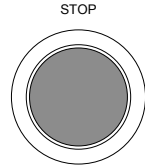

All panel keys except the STOP button are locked when the tester is in STOP status.

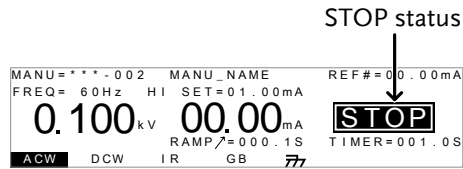

2. To put the tester back into READY status, press the STOP button again.

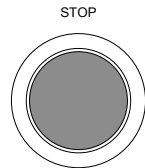

Exit TEST Status

To exit testing, press the MANU/AUTO key when the tester is in the READY status. The tester will revert to the VIEW status for the current test.

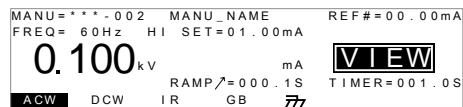

 Note

Do not touch any terminals, test leads or any other connections when the test is on.

## PASS / FAIL MANU Test

**Background** If the test is allowed to run to completion (the test is not stopped or a protection setting is not tripped) then the tester will judge the test as either PASS or FAIL.



**Note**

The test will be judged PASS when:

- The HI SET and LO SET limits have not been tripped during the test time.

The test will be judged FAIL when:

- Either the HI SET or LO SET limit has been tripped during the test time.
- A protection setting has been tripped during the test time. See page 164 for a list of error messages.

**PASS Judgment** 1. When the test is judged as PASS, PASS will be displayed, the buzzer will sound and the PASS indicator will be lit green.

PASS

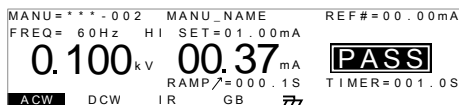

2. The PASS judgment will be held on the display until the STOP or START button is pressed.

Pressing the STOP button will return the tester to the READY status.

STOP

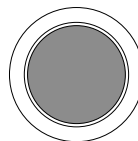

Pressing the START button will restart the test.

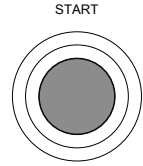

Note

The buzzer will only sound if the Pass Sound is set to ON. See page 99 for details.

The START button is disabled when the buzzer is beeping.

**PASS Timing Diagrams**

The timing diagrams below show the ACW, DCW, IR and GB timing for the START status, TEST status and PASS judgment.

**ACW PASS Timing**

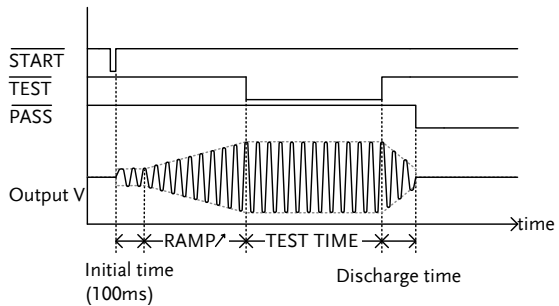

**DCW PASS Timing**

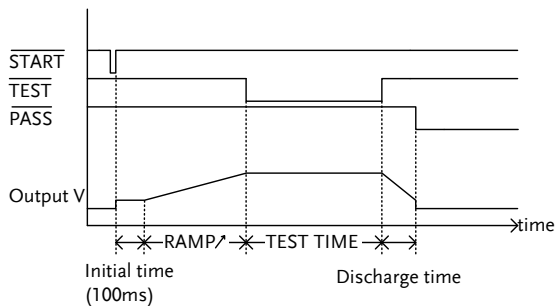

**IR PASS Timing**

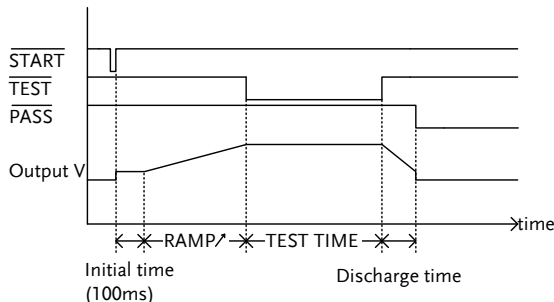

**GB PASS Timing**

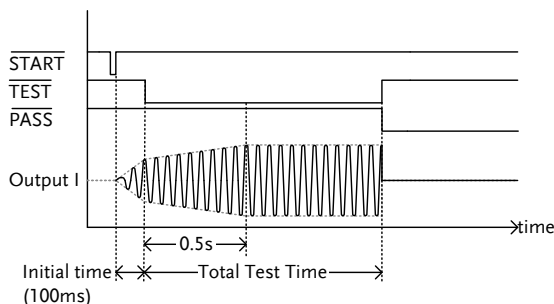

**FAIL Judgment**

1. When the test is judged as FAIL, FAIL will be displayed, the buzzer will sound and the FAIL indicator will be lit red.



As soon as a test is judged FAIL, power is cut from the terminals.

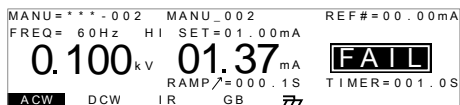

2. The FAIL judgment will be held on the display until the STOP button is pressed. Pressing the STOP button twice will return the tester to the READY status.

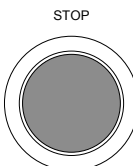

- The READY indicator will be lit blue in the READY status.

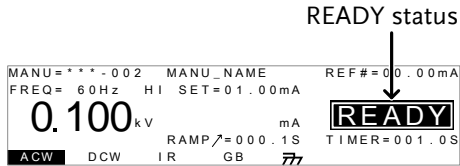

Note

The buzzer will only sound if Fail Sound is set to ON. See page 99 for details.

**FAIL Timing Diagrams**

The timing diagrams below show the ACW, DCW, IR and GB timing for the START status, TEST status and FAIL judgment.

**ACW FAIL Timing**

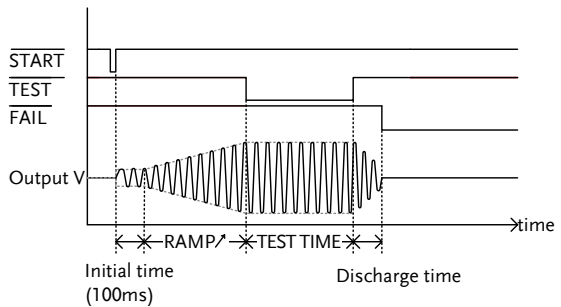

**DCW FAIL Timing**

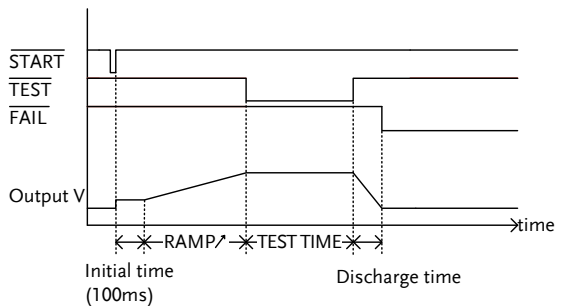

### IR FAIL Timing

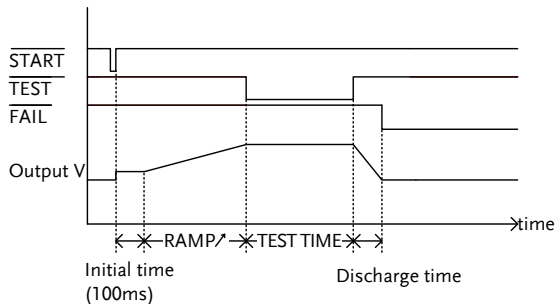

### GB FAIL Timing

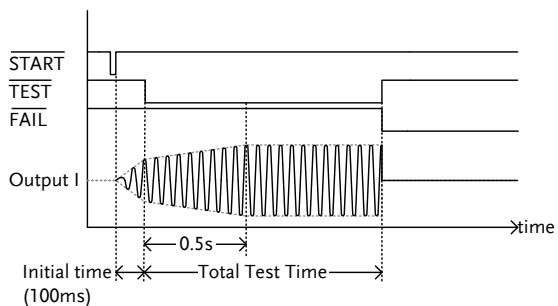



## Zeroing of the Test Leads (GB only)

### Background

The Zeroing function is used to determine the resistance of the test leads for GB tests. When a zero check is performed, the reference is automatically set to the measured resistance of the test leads.

This function is only available for GB testing.

### Steps

1. Ensure the tester is in VIEW status Page 63 for the current GB test. Save the current test if necessary.

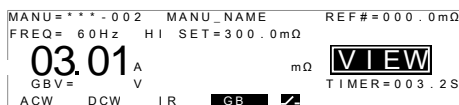

2. Short the positive and negative alligator clips as shown below.

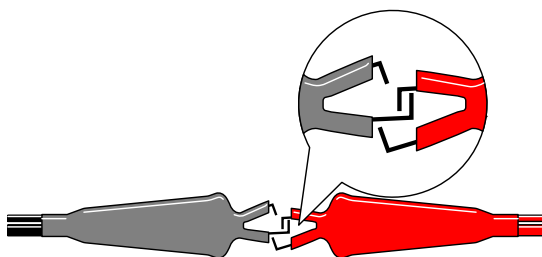

3. Press the STOP button to put the tester into the READY status.

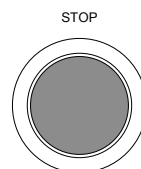

- The ZERO function can be activated by pressing the corresponding soft-key in the READY status. The ZERO soft-key will be highlighted.

ZERO



- Press the START button to perform the zero check. The tester will go into the ZERO status.

START

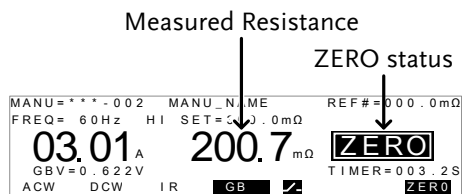
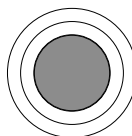

- When the zero check has finished, the tester will return back to the VIEW status. The resistance of the test leads will be automatically set as the Reference value.

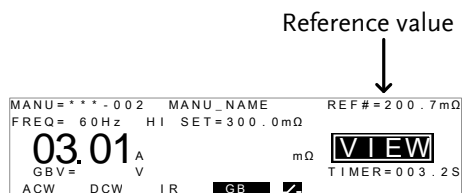

Note

Remember to replace the test leads to the proper position on the DUT before testing.

I<SET

If SOURCE H/L terminals are open or poorly connected, then an I<SET error will appear on the screen. Stop the test and re-check the connection again and try again.

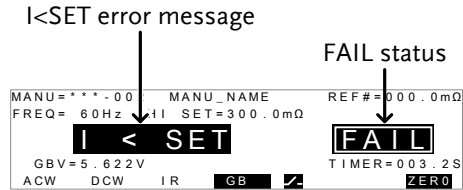

R = 0

Stop the test and perform the zero check again.

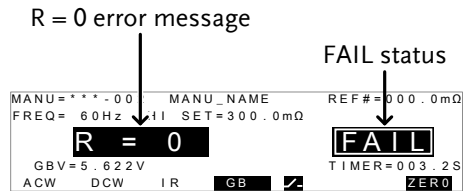

## Special MANU Test Mode (000)

---

### Special Test Mode Overview

When MANU number 000 is selected, the special test mode is activated. Under the special test mode, the voltage can be changed during a test, in real time (ACW, DCW only). The test function can also be changed when in READY or VIEW status, unlike under normal operation.

Separate settings can be saved under the special test mode for each of the testing functions: ACW, DCW, IR and GB. This means a different ACW, DCW, IR and GB test setup can be saved for MANU number 000.

---

### Sweep Function Overview

The GPT-9901A/9902A/9903/9903A and 9904 have access to the sweep mode function. The sweep function creates a graph of one of the ACW, DCW, IR or GB tests in the special manual mode. The graph will plot the output voltage, current or resistance versus time. After the test has been completed, the test current, voltage or resistance at any point in time can be viewed in the graph.

Below is an example of the resultant sweep plot of a DCW test where a DC voltage is ramped up to a user-defined level until the HI SET current level has been tripped or the test time runs out.

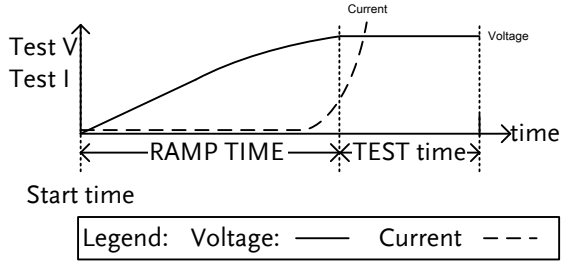

The test items that are plotted on the sweep graph depend on the type of test that is performed.

TEST	Graph Test Items
ACW	Test voltage, test current (V, I)
DCW	Test voltage, test current (V, I)
IR	Test voltage, test resistance (V, R)
GB	Test current, test resistance (I, R)

Steps

1. Choose MANU number 000 to enter the special test mode.
2. The settings of a previous test can be loaded by pressing the corresponding soft-key in the VIEW or READY status.

Page 39

ACW



Example:  
ACW

For example, if you are currently in DCW mode, pressing the ACW key will load the ACW settings that were previously used in the special manual mode.

- Set all the necessary parameters for Pages 40~63 a test and save.

Note: A different test setup can be saved for each test function (ACW, DCW, IR and GB).

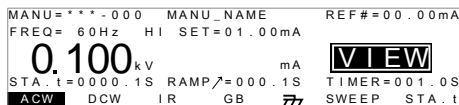

GPT-99XX/99XXA shown.



Note

The TIMER settings can be set OFF when in the special test mode for ACW and DCW tests.

If the TIMER settings are set to OFF, the sweep function will not produce a graph.

- When in the VIEW status, press the **STA.t** Start Time  for the sweep graph. Make sure that the sweep start time is significantly less than the test time. This setting is only applicable for the GPT-9901A/9902A/9903/9903A/9904.

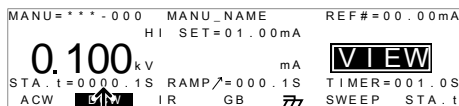

Start time

- Press the **EDIT/SAVE** key to save the Start time. 

Running the Test 1. In special test mode (000), tests are started and stopped in the same way as for the normal manual test mode. See page 64 for details. Page 64

2. If required, the scroll wheel can be used to set the voltage level in real-time as the test is running (this does not apply to IR or GB tests).

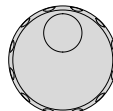

ACW 0.100kV ~ 5kV  
 DCW 0.100kV ~ 6kV

Results Test judgments are the same as those for the normal manual tests. Please see the PASS/FAIL MANU Test section for details. Page 68

View Sweep Graph Unlike normal manual tests, the special test mode also has an option to view the resultant test as a sweep graph.

This option is only available for the GPT-9901A/9902A/9903/9903A/9904.

- Steps 1. When the test has finished, press the SWEEP key to view the results of the sweep in a graph. 

Graph Test Items:		
TEST	Primary	Secondary
ACW	Test voltage	test current
DCW	Test voltage	test current
IR	Test voltage	test resistance
GB	Test current	test resistance

DCW Example

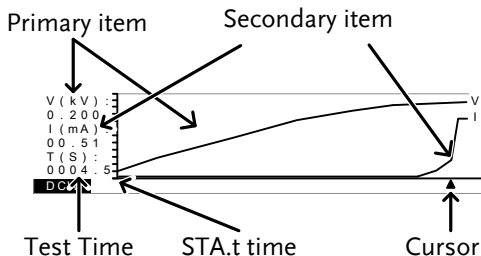

2. Use the scroll wheel to move the cursor on the time axis (x-axis). The measured values for the primary and secondary items at that particular point in time are shown on the left-hand side.

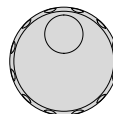

Remove Lines from the Graph

1. Pressing the F5 key will toggle the primary test item on/off.
2. Pressing the F6 key will toggle the secondary test item on/off.

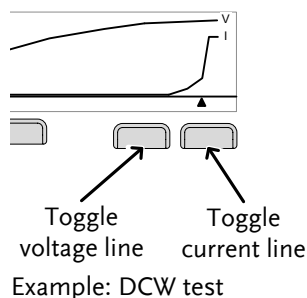

Exit the Results Graph

To exit the graph, press the ESC key. You will be returned back to MANU mode/VIEW status.





## Automatic Tests

This section describes how to create, edit and run automatic tests. Automatic tests allow you to link together up to 16 different MANU tests and run them sequentially. Each stored MANU test is used as a test step when creating an AUTO test.

- Choose/Recall an Automatic Test → from page 81
- Edit Automatic Test Settings → from page 83
- Adding a Step to the Automatic Test → from page 84
- Creating an AUTO Test File Name → from page 85
- Saving and Exiting EDIT Status → from page 86
- Automatic Test Page View → from page 87
- Running an Automatic Test → from page 90
- Automatic Test Results → from page 94

Before operating the GPT-9000/9000A please read the safety precautions as outlined in the Set Up chapter on page 23.

### Choose/Recall an Automatic Test

---

**Background**                      The tester must first be put into AUTO mode to create or run automatic tests.

Up to 100 automatic tests can saved/recalled.

- Steps**
1. If the tester is in MANU mode, press and hold the MANU/AUTO key for three seconds. This will put the tester into Auto mode.



The tester can only switch between AUTO and MANU mode when in the VIEW status.

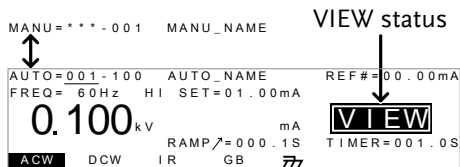

Note

If the chosen automatic test has not yet been setup, then the screen will be blank except for the status and mode.

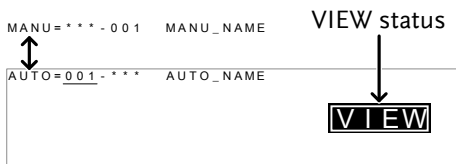

- Use the scroll wheel to choose the AUTO number.

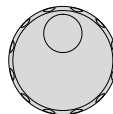

AUTO # 001~100

AUTO number

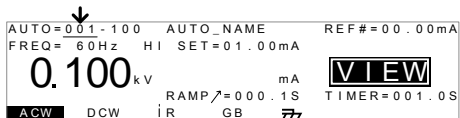

Note

The AUTO number can only be chosen in VIEW status. If in the EDIT status, switch to the VIEW status by pressing the EDIT/SAVE or ESC key.

## Edit Automatic Test Settings

**Background** To edit an automatic test, the tester must be in EDIT status.

Any settings or parameters that are edited only apply to the currently selected AUTO number.

- Steps**
1. Press the EDIT/SAVE key when in VIEW status to enter the EDIT status. This will enter the EDIT status for the chosen AUTO number.

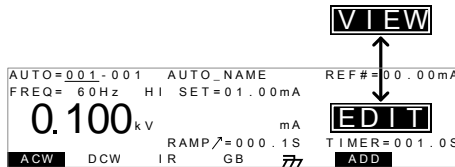

2. The Status changes from VIEW to EDIT. The tester is now ready to edit the current AUTO test.

**Note**

Pressing the EDIT/SAVE key again will save the settings or pressing the ESC will cancel the settings for the current AUTO test and return back to VIEW status.

## Adding a Step to the Automatic Test

**Background** Up to 16 MANU tests (steps) can be added to an automatic (AUTO) test. Each step is added in a sequential order.

**Steps**

1. Press the DOWN arrow keys to bring the cursor to the MANU number.

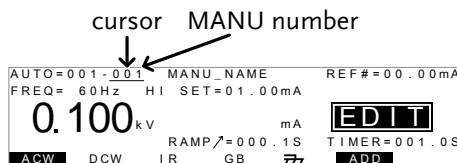

2. Use the scroll wheel to choose a MANU number to add to the automatic test.

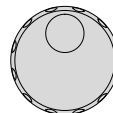

MANU number 001~100

3. Press the ADD soft-key to add the selected manual test to the automatic test as another step.



4. Repeat steps 2 and 3 for any other tests that you wish to add to the automatic test.



**Note**

After 16 steps have been added to an AUTO test, FULL will be shown on the display when you attempt to add another step to the AUTO test.

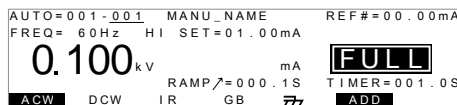



Note

The test order can be edited in the Page View menu after the AUTO test is saved. See page 87 for details.

## Creating an AUTO Test File Name

### Background



Each automatic test can have a user-defined test file name (Default: AUTO\_NAME) up to 10 characters long. See the character list below for the allowed characters.

#### Character List

0	1	2	3	4	5	6	7	8	9																
A	B	C	D	E	F	G	H	I	J	K	L	M	N	O	P	Q	R	S	T	U	V	W	X	Y	Z
a	b	c	d	e	f	g	h	i	j	k	l	m	n	o	p	q	r	s	t	u	v	w	x	y	z
+	-	*	/	_	=	:	Ω	?	(	)	<	>	[	]											

### Steps



1. Use the UP/DOWN arrow keys to bring the cursor to the AUTO number. A small cursor will also appear under the first character of the AUTO test file name. This is initially set as AUTO\_NAME
 

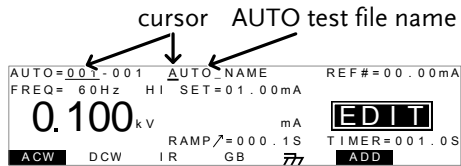

2. Use the scroll wheel to scroll through the available characters.
 

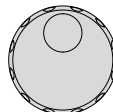
3. Press the LEFT/RIGHT arrow keys to go to the next character.
 

- The AUTO test file name is set when the current AUTO test is saved or when the cursor is moved to another setting.



Note

To cancel the name changes, press the ESC key before the cursor is moved to another setting or the name is saved.

## Saving and Exiting EDIT Status

### Background

After all test steps have been added to an automatic test, the automatic test can be saved.

### Steps

- When in EDIT status, press the EDIT/SAVE key to save the automatic test. After the test is saved the tester will revert back to VIEW status.

EDIT/SAVE

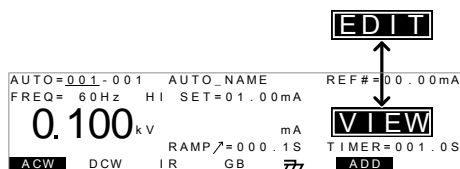

- The status changes from EDIT to VIEW.



Note

Pressing the EDIT/SAVE key again will return the tester back to EDIT status for the selected AUTO test.

## Automatic Test Page View

**Background** Pressing the PAGE key will show an overview of the tests for the currently selected automatic test when in the VIEW status. The Page View will show the order of the AUTO test steps as well as the manual file name, function, test voltage/current and HI/LO SET limits.

- Steps**
1. Ensure the tester has had an automatic test saved and the tester is in AUTO mode/VIEW status. Page 81

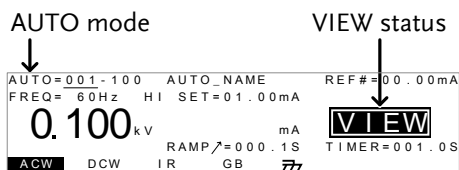

2. Press the PAGE key to bring up the Page view of the AUTO test. PAGE

All the test steps are shown on the bottom of the screen along with the corresponding MANU numbers. The top of the screen shows the selected MANU test file name and the settings (test function, test voltage, HI/LO SET).

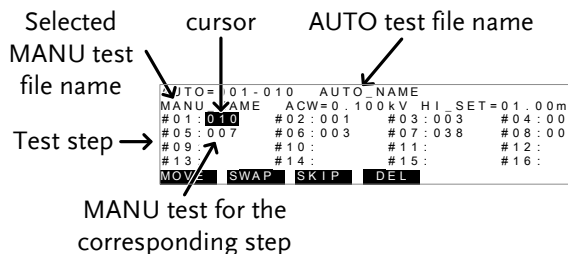

**Editing**

When in the Page View, the automatic test steps can be edited. Steps can be deleted, skipped, moved or swapped.

**Moving a Step**

1. Use the UP/DOWN and LEFT/RIGHT arrow keys to move the cursor to the test step you wish to move.

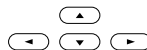

2. Press the MOVE soft-key.



3. Use the UP/DOWN and LEFT/RIGHT arrow keys to move the cursor to the destination step.



4. Press the MOVE soft-key again. The manual test will be moved to the destination step. The remaining steps will move up/down to fill the empty step.



```

AUTO=001-010  AUTO_NAME
MANU_NAME ACW=0.100kV HI SET=01.00mA
# 01: 010 # 02: 001 # 03: 003 # 04: 004
# 05: 0 # 06: 003 # 07: 038 # 08: 005
# 09: 0 # 10: # 11: # 12:
# 13: # 14: # 15: # 16:
MOVE SWAP SKIP DEL
    
```



Swapping Two Steps

1. Use the UP/DOWN and LEFT/RIGHT arrow keys to move the cursor to the test step you wish to swap.



2. Press the SWAP soft-key.



3. Use the UP/DOWN and LEFT/RIGHT arrow keys to move the cursor to the second step.



4. Press the SWAP soft-key again. The tests will be swapped with each other.



```
AUTO=001-010 AUTO_NAME
MANU_NAME ACW=0.100kV HI SET=01.00mA
# 01: 010 *001 # 03:003 # 04:004
# 05:007 # 06:003 # 07:038 # 08:005
# 09: # 10: # 11: # 12:
# 13: # 14: # 15: # 16:
MOVE SWAP SKIP DEL
```

Skip a Test Step

1. Use the UP/DOWN and LEFT/RIGHT arrow keys to move the cursor to the test step you wish to skip.



2. Press the SKIP soft-key.





3. The step will have an asterisk beside the MANU number.



```
AUTO=001-010 AUTO_NAME
MANU_NAME ACW=0.100kV HI SET=01.00mA
# 01: 010 * # 03:003 # 04:004
# 05:007 # 06:003 # 07:038 # 08:005
# 09: # 10: # 11: # 12:
# 13: # 14: # 15: # 16:
MOVE SWAP SKIP DEL
```

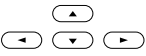

The next time the automatic test is run, the steps with asterisks will be skipped.

- Delete a Test Step
1. Use the UP/DOWN and LEFT/RIGHT arrow keys to move the cursor to the test step you wish to delete.
 
  2. Press the DEL soft-key.
 
  3. The step will be deleted.

Save Changes and Exit

To save the changes made in Page View, press the EDIT/SAVE key. You will be returned back to AUTO mode/VIEW status.



Cancel and Exit Page View

To cancel any changes and to exit the Page View, press the ESC key. You will be returned back to AUTO mode/VIEW status.



## Running an Automatic Test

Background

An automatic test can be run when the tester is in READY status.

 Note

The tester cannot start to run an AUTO test under the following conditions:

- Any protection modes have been tripped.
- The INTERLOCK function is ON and the Interlock key is not inserted in the signal I/O port (page 110).
- The STOP signal has been received remotely.

If Double Action is ON, ensure the START

button is pressed immediately after the STOP button (<0.5s).



**Warning**

Do not touch any terminals, test leads or the DUT when a test is running.

**Steps**

1. Ensure the tester is in VIEW status. Page 81 Save the automatic test if necessary.

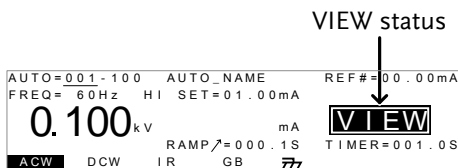

2. Press the STOP button to put the tester into the READY status.

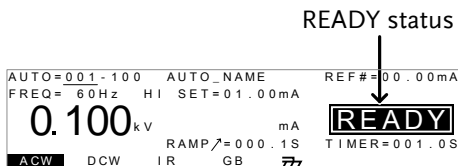
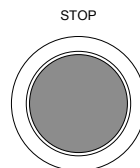

3. The READY indicator will be lit blue when in the READY status.



4. Press the START button when the tester is in the READY status. The AUTO test starts automatically and the display changes to TEST status.

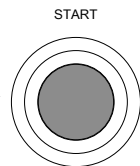

- 5. The TEST indicator will be lit TEST   
orange when in the TEST status.

- 6. Each test will start by showing the remaining ramp up time, followed by the remaining test time. Each test will be tested in sequence until the last test has finished or the test is stopped.





remaining RAMP time      remaining TIMER time

- PASS/FAIL HOLD 1. If Pass Hold is set to ON or Fail Mode is set to HOLD for a manual test, then the tester will “hold” the testing after a Pass/Fail result for that particular test. See page 54, 56 for details.

HOLD status



- 2. The PASS or FAIL indicator will also be lit. The buzzer will NOT sound. PASS   
FAIL 

- 3. To continue to the next test after HOLD is displayed on-screen, press the START button.

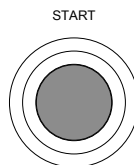

- To stop the test when HOLD is displayed on-screen, press the STOP button.

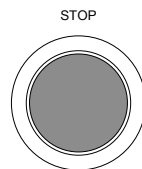

Note

When in HOLD status, only the START and STOP buttons can be pressed, all other keys are disabled.

Stop a Running Test

- To stop the AUTO test at any time when it is running, press the STOP button. The AUTO test will stop immediately. When the STOP button is pressed, a judgment is not made on the current test and any remaining tests are aborted.

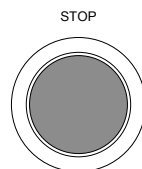

All panel keys except the STOP and START buttons are locked when the tester has been stopped. All the results up until when the AUTO test was stopped are shown on-screen. See page 94 for more details on automatic test results.

```
AUTO=001-***  AUTO_NAME
#01: FAIL  #02: PASS  #03: STOP  #04: ----
#05: ----  #06: ----  #07: ----  #08: ----
#09:      #10:      #11:      #12:
#13:      #14:      #15:      #16:
```

Example of an automatic test that has been stopped. Dashes (-) indicate aborted test steps.

- To put the tester back into READY status, press the STOP button again.

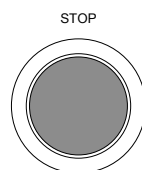

**Exit Testing**

To exit testing, press the **MANU/AUTO** key when the tester is in the **READY** status. The tester will revert to the **VIEW** status for the current automatic test.

MANU/AUTO

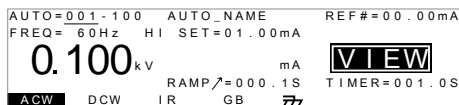

**Automatic Test Results**

**Background**

If all the test steps are allowed to run to completion (the **AUTO** test is not stopped or a protection setting is not tripped) then the tester will judge each step as either **PASS** or **FAIL**. This is shown as a table after the automatic test has finished running. If the test has been stopped, then any remaining tests will not be run and thus the **AUTO** test will not finish running.

**Overview**

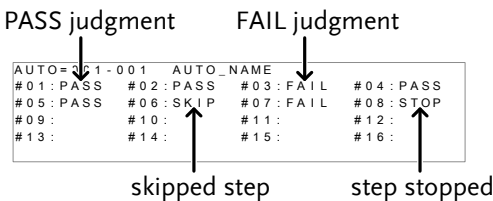

The **PASS/FAIL** judgment for an automatic test as a whole depends on the results of all the steps (manual tests) that compose the automatic test:

- Each step must be passed for a **PASS** judgment

(excluding skipped tests).

- A FAIL result for a single step will result in FAIL for the whole automatic test.
- A STOP. No step can be stopped for a PASS/FAIL judgment to be made. In other words, if a test is stopped, it is judged as neither PASS nor FAIL.
- No step can contain an ERROR or ILOCK message.

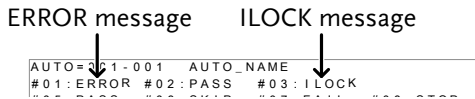

**ERROR:** Indicates that V, I or R is not correct. This usually occurs if the testing leads are not properly connected.

**ILOCK:** Indicates that the interlock key is disconnected (if configured to be used).

**PASS Judgment**

When all the tests have been judged as PASS, the PASS indicator will be lit green and the buzzer will sound.

PASS



```

AUTO=001-***  AUTO_NAME
#01:PASS #02:PASS #03:PASS #04:PASS
#05:PASS #06:PASS #07:PASS #08:PASS
#09:      #10:      #11:      #12:
#13:      #14:      #15:      #16:
  
```



The Pass Sound setting must to set to ON for the buzzer to sound (page 99).

**FAIL Judgment**

When any of the tests have been judged as FAIL, the FAIL indicator will be lit red and the buzzer will sound.

FAIL



AUTO=001-***		AUTO_NAME			
#01: PASS	#02: PASS	#03: PASS	#04: PASS	#05: PASS	#06: FAIL
#07: FAIL	#08: PASS	#09:	#10:	#11:	#12:
#13:	#14:	#15:	#16:		



Note

The Fail Sound setting must be set to ON for the buzzer to sound (page 99).

**View Results**

1. When the PASS or FAIL overview table is shown on the screen, turn the scroll wheel right to scroll through each test step.

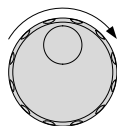

MANU number for current step

step number

PASS/FAIL result

2. Turn the scroll wheel left to return back to the overview table.

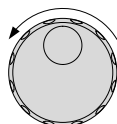

**Return to Ready Status**

1. The PASS/FAIL results will be held on the screen until the STOP button is pressed.

2. To put the tester back into READY status, press the STOP button (twice for a fail result).

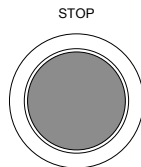

3. The READY indicator will be lit blue in the READY status.





READY status

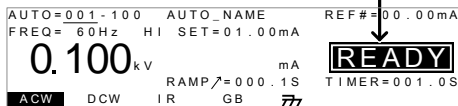

**Exit Testing**

To exit testing, press the MANU/AUTO key when the tester is in the READY status. The tester will revert to the VIEW status.

MANU/AUTO

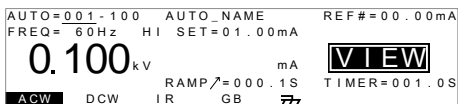

**PASS Timing Diagram**

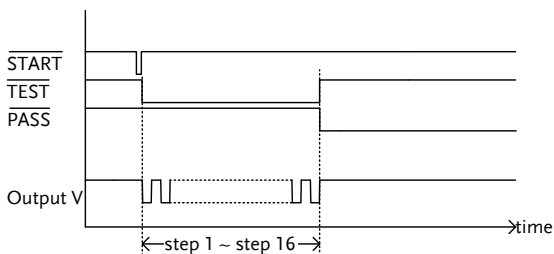

**FAIL Timing Diagram**

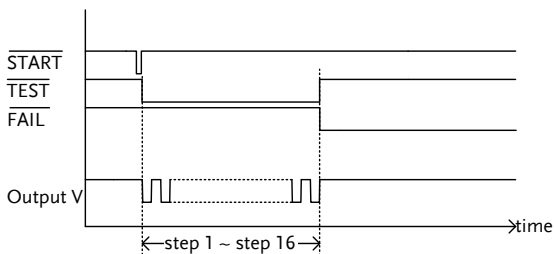

## Common Utility Settings

The Common Utility settings are system-wide settings that apply to both MANU tests and AUTO tests.

The Common Utility menu includes the following settings:

- LCD settings → from page 98.
- Buzzer Settings → from page 99.
- Interface Settings → from page 100.
- Control settings → from page 102.

### LCD Settings

**Description**                      The LCD settings include contrast and brightness controls.

- Steps**
1. Ensure the tester is in VIEW status. Page 63  
Save the current test if necessary.

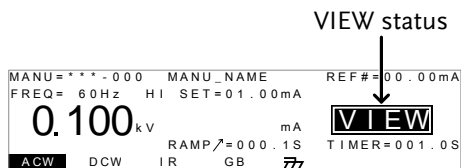



2. Press the UTILITY key.



3. Press the LCD soft-key to bring up the LCD Common Utility menu.

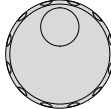

- 4. Use the UP/DOWN arrow keys to choose a menu item: LCD Contrast, LCD Brightness.  

- 5. Use the scroll wheel to select a parameter for the chosen menu item. 

LCD Contrast      1(low) ~ 8(high)  
 LCD Brightness    BRIGHT, DARK

- 6. Press EDIT/SAVE to save the settings and exit to VIEW status. 



Note

The ESC key can be pressed at any time to cancel and exit back to VIEW status.

## Buzzer Settings

**Description**      The Buzzer settings allow you to set whether the buzzer will sound for PASS/FAIL judgments. The buzzer time can also be set for the PASS/FAIL judgments. The buzzer settings are system-wide.

- Steps**
- 1. Ensure the tester is in VIEW status. Page 63 Save the current test if necessary.

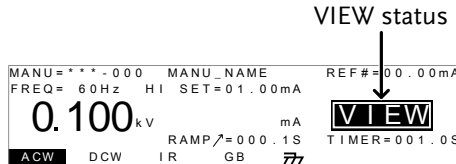

- 2. Press the UTILITY key. 

3. Press the BUZZ soft-key to bring up the Buzzer Common Utility menu.



4. Use the UP/DOWN arrow keys to choose a menu item: Pass Sound or Fail Sound.

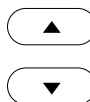

5. Use the scroll wheel to select a parameter for the chosen menu item.

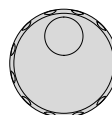

Pass Sound	ON (000.2s~999.9s), OFF
Fail Sound	ON (000.2s~999.9s), OFF

6. Press EDIT/SAVE to save the settings and exit to the VIEW status.



Note

When in automatic tests, the Pass Sound and Fail Sound settings only apply to the overall PASS/FAIL of the *overall automatic test*, not each test step that make up the automatic tests.



Note

The ESC key can be pressed at any time to cancel and exit back to VIEW status.

## Interface Settings

Description	The interface settings choose the remote interface configuration. USB, RS232 and GPIB (optional) can be selected.
-------------	---

Steps

1. Ensure the tester is in VIEW status. Page 63  
Save the current test if necessary.

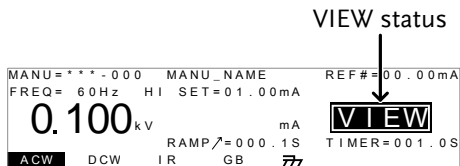

2. Press the UTILITY key.



3. Press the INTER soft-key to bring up the Interface Common Utility menu.



4. Use the scroll wheel to select USB, RS232 or GPIB.

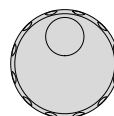

5. For RS232 or GPIB, use the UP/DOWN arrow keys to choose Baud or Address.

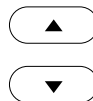

6. Use the scroll wheel to select the baud rate or GPIB address.

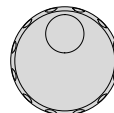

Baud	9600, 19200, 38400, 57600, 115200
GPIB address	0~30

7. Press EDIT/SAVE to save the settings and exit to VIEW status.

EDIT/SAVE



Note

Ensure the baud rate settings or GPIB address matches the host machine.



Note

The ESC key can be pressed at any time to cancel and exit back to VIEW status.

## Control Settings

---

### Description

The Control settings are accessed in the COMMON UTILITY menu. The Control settings include: Start Control, Double Action, Key Lock and Interlock.

Start Control is used to determine how a test is started. Tests can be started via the front panel (START/STOP buttons), from a remote controller or via the SIGNAL I/O port.

The Double Action function is a safety feature used to prevent accidentally starting a test. Normally to start a test, the START button is pressed when the tester is in the READY status. To start a test when Double Action is ON, the STOP button must first be pressed, followed by the START button within 500ms.

Key Lock disables the front panel keys from changing the test number, mode or testing parameters. Only the Utility menu and any keys required for testing are not disabled.

The Interlock function is a safety feature. The interlock function prevents a test from running, unless the interlock pins on the signal I/O port connector are shorted. The included interlock key can be used for this purpose. See page 110 for details.

**Steps**

1. Ensure the tester is in VIEW status. Page 63  
Save the current test if necessary.

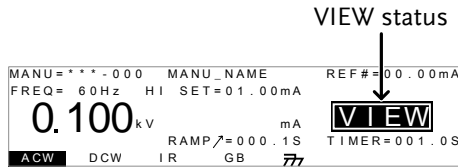

2. Press the UTILITY key.



3. Press the CTRL soft-key to bring up the Control Common Utility menu.

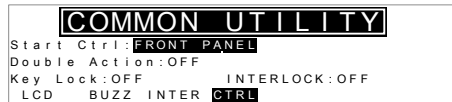

4. Use the UP/DOWN arrow keys to choose a menu item: Start Ctrl, Double Action, Key Lock or INTERLOCK.

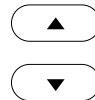

5. Use the scroll wheel to select setting for the chosen menu item.

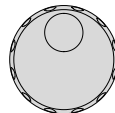

Start Ctrl	FRONT PANEL, REMOTE CONNECT, SIGNAL IO
Double Action	ON, OFF
Key Lock	ON, OFF
INTERLOCK	ON, OFF

6. Press EDIT/SAVE to save the settings and exit to VIEW status. 



Note

The Double Action setting is ignored when the GPT-9000/9000A is being controlled remotely using the USB, RS232 or GPIB interfaces.



Note

If a test is started with INTERLOCK ON, but the interlock signal I/O pins are not shorted (either with the included interlock key or manually), the INTERLOCK OPEN message will be displayed, preventing the test from starting.

Interlock open message

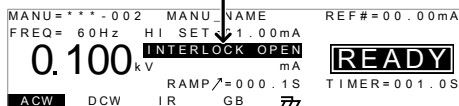



# E XTERNAL CONTROL

The External Control chapter covers the  
REMOTE terminal and the SIGNAL I/O port.

---

<b>External Control Overview .....</b>	<b>106</b>
Remote Terminal Overview .....	106
Remote Controller Operation .....	107
SIGNAL I/O Overview .....	108
Using the SIGNAL I/O to Start/Stop Tests .....	110
Using the Interlock Key .....	111

## External Control Overview

The External Control section describes the front panel REMOTE terminal connection and the rear panel SIGNAL I/O port.

### Remote Terminal Overview

---

**Overview** The REMOTE terminal connector is a standard 5-pin DIN terminal suitable for a remote controller.

---



**WARNING**

Keep any cables that are connected to the REMOTE terminal away from the HIGH VOLTAGE and RETURN terminals.

---

#### Pin Assignment and Connection

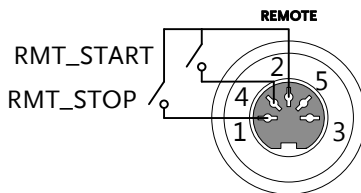

Pin	Pin name	Description
1	RMT_STOP	Remote Stop signal
2	COM	Common line
3	Not used	
4	RMT_START	Remote Start signal
5	Not used	

#### Signal Properties

High level input voltage	2.4V~3.3V
Low level input voltage	0~0.8V
Input period	minimum of 1ms

## Remote Controller Operation

---

**Description** The GPT-9000/9000A accepts external remote controllers with a START and STOP button. To use the REMOTE terminal, the GPT-9000/9000A must first be configured to accept a remote controller.

Operating a remote controller is the same as operating the START and STOP buttons on the front panel.

### Steps

1. Insert the lead of remote controller into the REMOTE terminal.

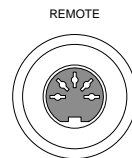

2. Configure the Start Ctrl option to REMOTE CONNECT in the Common Utility menu. [Page 102](#)
3. The tester will now only be able to start a test using a remote controller.

### NOTE

Even if the GPT-9000/9000A is configured to use the REMOTE CONNECT option, the STOP button on the front panel can still be used to stop a test.

4. To return the operation control to the front panel, configure the Start Ctrl option to FRONT PANEL. [Page 102](#)

## SIGNAL I/O Overview

**Overview**                      The SIGNAL I/O port can be used to remotely start/stop tests and monitor the test status of the instrument. The SIGNAL I/O port is also used for the interlock function (page 102).

The SIGNAL I/O port uses a DB-9 pin female connector.

### Pin Assignment

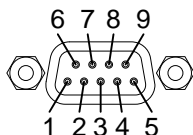

Pin name	Pin	Description
INTERLOCK1	1	When INTERLOCK is ON, a test is only allowed to start when both INTERLOCK pins are shorted.
INTERLOCK2	2	
INPUT_COM	3	Common input line
INPUT_START	4	Start signal input
INPUT_STOP	5	Stop signal input
OUTPUT_TEST	6	Indicates that a test is in progress
OUTPUT_FAIL	7	Indicates that a test has failed
OUTPUT_PASS	8	Indicates that a test has passed
OUTPUT_COM	9	Common output line

### Interlock connection

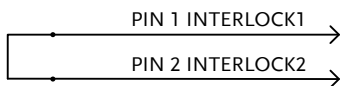

### Input Connection

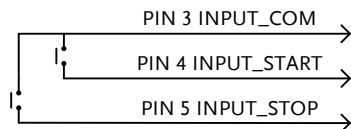

Output  
Connection

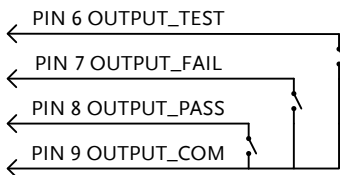

Signal Properties

**Input Signals**

High level input voltage	5V ~ 32V
Low level input voltage	0V ~ 1V
Low level input current	Maximum of -5mA
Input period	Minimum of 1ms

**Output Signals**

Output Type	Relay form A
Output Rated Voltage	30VDC
Maximum output current	0.5A

## Using the SIGNAL I/O to Start/Stop Tests

---

Background                      To use the SIGNAL I/O port the Start Ctrl settings have to be set to SIGNAL I/O in the Common Utility menu.

---

- Panel operation
1. Set the Start Ctrl option to SIGNAL Page 102 I/O.
  2. Connect the Input/Output signals to the SIGNAL I/O port.
  3. To start the testing, short the INPUT\_STOP and INPUT\_COM line for a minimum of 1ms to put the tester into READY status.
  4. To start the testing, short the INPUT\_START and INPUT\_COM lines for a minimum of 1ms.
  5. To stop the testing, temporarily short the INPUT\_STOP and INPUT\_COM line again.
- 



### NOTE

Even if the GPT-9000/9000A is configured to use the SIGNAL I/O interface, the STOP button on the front panel can still be used to stop a test.

---

## Using the Interlock Key

---

**Background** When the INTERLOCK function is set to ON, tests are only allowed to start when both Interlock pins on the signal I/O port are shorted. Using the Interlock key will short the INTERLOCK1 and INTERLOCK2 pins on the signal I/O port. See page 108 for the Signal I/O pin assignment.

---

- Panel operation**
1. Insert the Interlock key into the SIGNAL I/O port on the rear panel.
  2. Set the INTERLOCK option to ON Page 102 in the Common Utility.

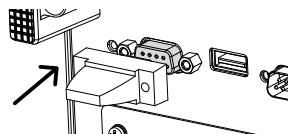

With INTERLOCK set to ON, the tester can now only start a test when the Interlock key is connected. Do not remove the interlock after starting a test. It must be connected after a test has started or is running.

Set INTERLOCK to OFF to disable this feature.

---

# REMOTE CONTROL

This chapter describes basic configuration of IEEE488.2 based remote control. The remote interface supports USB, RS232 and GPIB.

---

Interface Configuration .....	113
Command Syntax .....	117
Command List.....	120
Error Messages .....	159



## Interface Configuration

### USB Remote Interface

---

USB Configuration	PC side connector	Type A, host
	GPT-9XXX side connector	Rear panel Type A
	USB Class	CDC (communications device class)

---

- |                 |   |   |
|-----------------|---|---|
| Panel operation | 1. Connect the USB cable to the rear panel USB A port.    |  |
|                 | 2. Set the interface to USB from the Common Utility menu. |   |
- 



Note

When USB is used for remote control, an RS232 port is simulated. Check the Windows Device Manager for the baud rate and other RS232 settings. Check the RS232 configuration below for more details.

---

### RS232 Remote Interface

---

RS232 Configuration	Connection	Null modem cable
	Baud rate	9600, 19200, 38400, 57600, 115200
	Parity	None
	Data bits	8
	Stop bit	1
	Flow control	None

---

Pin Assignment

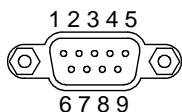

- 1: No connection
- 2: RxD (Receive Data)
- 3: TxD (Transmit Data)
- 4: No connection
- 5: GND
- 6-9: No connection

Connection	PC		Tester	
	DB9 Pin	Signal	Signal	DB9Pin
	2	RxD	TxD	3
	3	TxD	RxD	2
	5	GND	GND	5

Panel operation

1. Connect the Null modem cable to the rear panel RS232 port.
2. Set the interface to RS232 from the Common Utility menu.

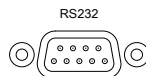

Page 100  
Common Utility menu.

## GPIB Remote Interface

GPIB Configuration	Address	0-30
--------------------	---------	------

Panel operation

1. Connect the GPIB cable to the rear panel GPIB port.
2. Set the interface to GPIB and set the GPIB address from the Common Utility menu.

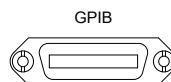

Page 100

## USB/RS232 Remote Control Function Check

---

Functionality  
check

Invoke a terminal application such as Hyper Terminal.

To check the COM port number and other settings, see the Device Manager in the PC. For WinXP; Control panel → System → Hardware tab.

---

Run this query command via the terminal after the instrument has been configured for USB or RS232 remote control (page 113, 113).

\*idn?

This should return the Model number, Serial number, and Firmware version in the following format:

GPT-9803, XXXXXXXXXXXXX, V1.00

Model number : GPT-9803

Serial number :12 character serial number

Firmware version : V1.00

- ^j can be used as the terminal character when entering the queries/commands from a terminal application.
-

**Display** When the panel is being remotely controlled via the USB, RS232 or GPIB interfaces, RMT will be displayed on the screen.

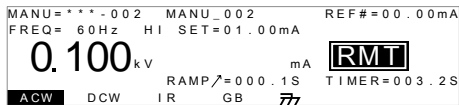

## Return to Panel Control

---

**Background** When the instrument is remotely controlled all panel keys except the STOP button are disabled.

**Steps** 1. When RMT is on the display, press the STOP button. The panel goes to the READY status.

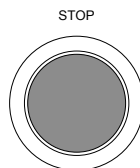

2. From the READY status the tester can go into one of two states: TEST or VIEW.

- To put the tester into VIEW status, press the MANU/AUTO key.



- To put the tester in TEST status, press the START button. This will start the manual test/automatic test. For more details on running a manual test or automatic test, see pages 64 and 90, respectively.

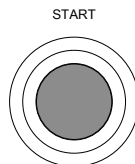

 **Note**

To put the tester back to RMT, simply issue another remote control command.

## Command Syntax

---

Compatible Standard	IEEE488.2	Partial compatibility
	SCPI, 1999	Partial compatibility

---

**Command Structure**

SCPI commands follow a tree-like structure, organized into nodes. Each level of the command tree is a node. Each keyword in an SCPI command represents each node in the command tree. Each keyword (node) of an SCPI command is separated by a colon (:).

For example, the diagram below shows an SCPI sub-structure and a command example.

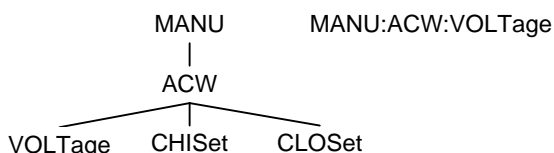

**Command types**

There are a number of different instrument commands and queries. A command sends instructions or data to the unit and a query receives data or status information from the unit.

Command types

---

**Setting**                      A single or compound command with/without a parameter

**Example**                      MANU:STEP 1

---

Query                      A query is a simple or compound command followed by a question mark (?). A parameter (data) is returned.

Example                    MANU:ACW:VOLTage?

**Command Forms**            Commands and queries have two different forms, long and short. The command syntax is written with the short form of the command in capitals and the remainder (long form) in lower case.

The commands can be written in capitals or lower-case, just so long as the short or long forms are complete. An incomplete command will not be recognized.

Below are examples of correctly written commands.

Long form	SYSTem:BUZZer:KEYSound SYSTEM:BUZZER:KEYSOUND system:buzzer:keysound
Short form	SYST:BUZZ:KEYS syst:buzz:keys

**Command Format**

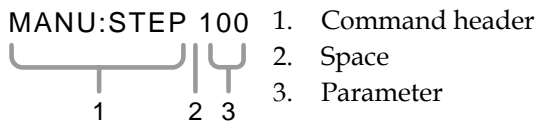

**Parameters**

Type	Description	Example
<Boolean>	Boolean logic	0, 1
<NR1>	integers	0, 1, 2, 3
<NR2>	decimal numbers	0.1, 3.14, 8.5

	<NR3>	floating point	4.5e-1, 8.25e+1
	<NRf>	any of NR1, 2, 3	1, 1.5, 4.5e-1
	<string>	ASCII text string	TEST_NAME
Message Terminator	CR, LF	Carriage Return, Line feed code	

---

## Command List

---

System	SYSTem:LCD:CONTRast .....	123
Commands	SYSTem:LCD:BRIGhtness.....	123
	SYSTem:BUZZer:PSOUND .....	124
	SYSTem:BUZZer:FSOUND .....	124
	SYSTem:BUZZer:PTIME .....	124
	SYSTem:BUZZer:FTIME.....	125
	SYSTem:ERRor .....	125
	SYSTem:GPIB:VERSion.....	126
Function	FUNCTion:TEST .....	127
Commands	MEASure<x> .....	127
	MAIN:FUNCTion.....	128
Manual	MANU:STEP .....	
Commands	MANU:NAME.....	130
	MANU:RTIME .....	130
	MANU:EDIT:MODE.....	131
	MANU:ACW:VOLTage .....	131
	MANU:ACW:CHISet.....	132
	MANU:ACW:CLOSet.....	132
	MANU:ACW:TTIME .....	133
	MANU:ACW:FREQuency .....	134
	MANU:ACW:REF .....	134
	MANU:ACW:ARCCurrent.....	135
	MANU:DCW:VOLTage .....	135
	MANU:DCW:CHISet.....	136
	MANU:DCW:CLOSet.....	136
	MANU:DCW:TTIME .....	137
	MANU:DCW:REF .....	138
	MANU:DCW:ARCCurrent.....	138
	MANU:IR:VOLTage .....	139
	MANU:IR:RHISet.....	139
	MANU:IR:RLOSet.....	140



	MANU:IR:TTIME .....	140
	MANU:IR:REF .....	141
	MANU:GB:CURRent .....	141
	MANU:GB:RHISet .....	142
	MANU:GB:RLOSet .....	142
	MANU:GB:TTIME .....	142
	MANU:GB:FREQuency .....	143
	MANU:GB:REF .....	143
	MANU:GB:ZEROCHECK .....	144
	MANU:UTILity:ARCMoDe .....	144
	MANU:UTILity:PASShold .....	145
	MANU:UTILity:FAILmoDe .....	145
	MANU:UTILity:MAXHold .....	145
	MANU:UTILity:GROUNDMODE .....	146
	MANU<x>:EDIT:SHOW .....	146
Sweep	SWEEP:DATA:STATus .....	147
Commands	SWEEP<X>:DATA:SHOW .....	148
	SWEEP:GRAPh:SHOW .....	149
	SWEEP :GRAPh:LINE .....	149
	SWEEP:STARt:TIME .....	150
Auto Commands	AUTO<x>:PAGE:SHOW .....	152
	AUTO:PAGE:MOVE .....	152
	AUTO:PAGE:SWAP .....	153
	AUTO:PAGE:SKIP .....	153
	AUTO:PAGE:DEL .....	154
	AUTO:NAME .....	154
	AUTO:EDIT:ADD .....	155
	TESTok:RETurn .....	155
	*SRE .....	156
Common	*CLS .....	157
Commands	*IDN .....	157

Remote	*RMTOFF .....	158
Commands		
Special Functions	Inter Lock Key Open.....	158

## System Commands

SYSTem:LCD:CONTRast.....	123
SYSTem:LCD:BRIGHtness .....	123
SYSTem:BUZZer:PSOUND.....	124
SYSTem:BUZZer:FSOUND.....	124
SYSTem:BUZZer:PTIME .....	124
SYSTem:BUZZer:FTIME .....	125
SYSTem:ERRor .....	125
SYSTem:GPIB:VERSion .....	126

### SYSTem:LCD:CONTRast (Set) → → (Query)

Description	Sets the contrast of the LCD display from 1 (low) to 8 (bright).
Syntax	SYSTem:LCD:CONTRast <NR1>
Query Syntax	SYSTem:LCD:CONTRast?
Parameter/ Return parameter	<NR1> 1~8
Example	SYST:LCD:CONT 5 Sets the display contrast to 5.

### SYSTem:LCD:BRIGHtness (Set) → → (Query)

Description	Sets the brightness of the LCD display from 1(dark) to 2(bright).
Syntax	SYSTem:LCD:BRIGHtness <NR1>
Query Syntax	SYSTem:LCD:BRIGHtness?
Parameter/ Return parameter	<NR1> 1 (dark), 2 (bright)
Example	SYST:LCD:BRIG 2 Sets the display brightness to bright.

**SYSTEM:BUZZer:PSOUND** (Set) →  
→ (Query)

Description	Turns the buzzer sound on or off for a PASS judgment.	
Syntax	SYSTEM:BUZZer:PSOUND{ON OFF}	
Query Syntax	SYSTEM:BUZZer:PSOUND ?	
Parameter/ Return parameter	ON	PASS Sound on.
	OFF	PASS Sound off.
Example	SYST:BUZZ:PSOUND ON Turns the buzzer sound on for PASS judgments.	

**SYSTEM:BUZZer:FSOUND** (Set) →  
→ (Query)

Description	Turns the buzzer sound on or off for a FAIL judgment.	
Syntax	SYSTEM:BUZZer:FSOUND{ON OFF}	
Query Syntax	SYSTEM:BUZZer:FSOUND ?	
Parameter/ Return parameter	ON	FAIL Sound on.
	OFF	FAIL Sound off.
Example	SYST:BUZZ:FSOUND ON Turns the buzzer sound on for FAIL judgments.	

**SYSTEM:BUZZer:PTIME** (Set) →  
→ (Query)

Description	Sets the PASS sound duration in seconds.	
Syntax	SYSTEM:BUZZer:PTIME <NR2>	
Query Syntax	SYSTEM:BUZZer:PTIME?	
Parameter/ Return parameter	<NR2>	0.2~999.9
Example	SYST:BUZZ:PTIM 1 Sets the buzzer to 1 second for a PASS judgment.	

**SYSTem:BUZZer:FTIME** (Set) →  
→ (Query)

Description	Sets the FAIL Sound duration in seconds.
Syntax	SYSTem:BUZZer:FTIME <NR2>
Query Syntax	SYSTem:BUZZer:FTIME?
Parameter/ Return parameter	<NR2> 0.2~999.9
Example	SYST:BUZZ:FTIM 1 Sets the buzzer to 1 second for a FAIL judgment.

**SYSTem:ERRor** → (Query)

Description	Returns any errors in the output buffer. See the error code table below for details.
Query Syntax	SYSTem:ERRor ?
Return parameter	<string> Returns an error string that includes an error code and an error description.

**Error Code Table**

Error code, Error description
0, No Error
20, Command Error
21, Volume Error
22, String Error
23, Query Error
24, Mode Error
25, Time Error
26, DC Over 50W (GPT-98XX), DC Over 100W (GPT-99XX/99XXA)
27, GBV > 5.4V
30, Voltage Setting Error
31, Current Setting Error
32, Current HI SET Error
33, Current LOW SET Error
34, Resistance HI SET Error

- 35,Resistance HI SET Error
- 36,REF Setting Error
- 37,Frequency Setting Error
- 38,ARC Setting Error
- 39,RAMP Time Setting Error
- 40,TEST Time Setting Error

Example            SYST:ERR ?  
                      >0,No Error  
                      Returns "0,No Error" as the error message.

**SYSTEM:GPIB:VERSion**

→ Query

Description        Queries the GPIB version.

Query Syntax        SYSTEM:GPIB:VERSion?

Return parameter	<code>&lt;string&gt;</code>	Returns: The GPIB version as a string "GPIB,V1.00" or "No GPIB connected" if there is not a GPIB device configured/connected.
------------------	-----------------------------	--

Query Example     SYST:GPIB:VERS?  
                      >GPIB,V1.00  
                      Returns the GPIB version.

**Function Commands**

FUNCTION:TEST.....	127
MEASure<x> .....	127
MAIN:FUNCTION .....	128

**FUNcTion:TEST**

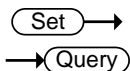

Description	Turns the currently selected test (output) on or off.	
	When HOLD is displayed on the screen during AUTO tests, use the FUNcTion:TEST command to move on to the next step.	
	Setting the FUNcTion:TEST command to OFF at the end of a test will also temporarily turn the PASS/FAIL buzzer sound off.	
Syntax	FUNcTion:TEST {ON OFF}	
Query Syntax	FUNcTion:TEST?	
Parameter	ON	Turns the test on.
	OFF	Turns the test off.
Return parameter	TEST ON	Test is on.
	TEST OFF	Test is off.
Example	FUNc:TEST ON Turns the output on.	

**MEASure<x>**



Description	Returns the test parameters & results of the tester in either MANU or AUTO mode.	
	MANU mode: Returns the test parameters & results of a MANU test.	
	AUTO mode: Returns the test parameters & results of the selected step (1-16) of the AUTO test.	
	Return parameters: function, judgment/status, test voltage, test current/resistance, test time (time of completed test) or ramp time (elapsed time of test that has not been completed).	
Query Syntax	MEASure<x>?	

Parameter (MANU mode)		No parameter needed for MANU mode.
Parameter (AUTO mode)	<x>	<NR1>1~16. Step number.
Return parameter	<string>	Returns the test status of the test in the following format: function, judgment or status, test voltage, test current or resistance, test time or ramp time
	Function	ACW, DCW, IR, GB
	Judgment /Status	PASS, FAIL VIEW
	Test voltage	voltage+unit
	Test current /Test resistance	current+unit resistance+unit
	Test time /Ramp time	T=time+S R=time+S

Example (in MANU mode) MEAS?  
>ACW, FAIL , 0.024kV ,0.013 mA ,R=000.1S  
Returns the test result of the current manual test.

Example (in AUTO mode) MEAS10?  
>IR, FAIL ,0.225kV ,999M ohm,T=010.3S  
Returns step 10 of the current automatic result.

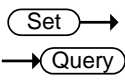

**MAIN:FUNCTION**



Description	Changes the mode between AUTO and MANU.	
Syntax	MAIN:FUNCTION {MANU AUTO}	
Query Syntax	MAIN:FUNCTION ?	
Parameter/	MANU	Puts the tester mode to MANU.
Return parameter	AUTO	Puts the tester mode to AUTO.
Example	MAIN:FUNC MANU Sets the tester to MANU mode.	



## Manual Commands

---



MANU:STEP .....	130
MANU:NAME .....	130
MANU:RTIME .....	130
MANU:EDIT:MODE .....	131
MANU:ACW:VOLTag .....	131
MANU:ACW:CHISet .....	132
MANU:ACW:CLOSet .....	132
MANU:ACW:TTime .....	133
MANU:ACW:FREQuency .....	134
MANU:ACW:REF .....	134
MANU:ACW:ARCCurrent .....	135
MANU:DCW:VOLTag .....	135
MANU:DCW:CHISet .....	136
MANU:DCW:CLOSet .....	136
MANU:DCW:TTime .....	137
MANU:DCW:REF .....	138
MANU:DCW:ARCCurrent .....	138
MANU:IR:VOLTag .....	139
MANU:IR:RHISet .....	139
MANU:IR:RLOSet .....	140
MANU:IR:TTime .....	140
MANU:IR:REF .....	141
MANU:GB:CURRent .....	141
MANU:GB:RHISet .....	142
MANU:GB:RLOSet .....	142
MANU:GB:TTime .....	142
MANU:GB:FREQuency .....	143
MANU:GB:REF .....	143
MANU:GB:ZEROCHECK .....	144
MANU:UTILity:ARCMODE .....	144
MANU:UTILity:PASShold .....	145
MANU:UTILity:FAILmode .....	145
MANU:UTILity:MAXHold .....	145
MANU:UTILity:GROUNDMODE .....	146
MANU<x>:EDIT:SHOW .....	146

<b>MANU:STEP</b>	
Description	Sets the MANU test number.
Syntax	MANU:STEP <NR1>
Query Syntax	MANU:STEP?
Parameter/ Return parameter	<NR1> 0~100.
Example	MANU:STEP 100 Sets the manual test number to 100.

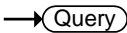
<b>MANU:NAME</b>	
Description	Sets or returns the test name for the selected manual test. The test must be in MANU mode before this command can be used. Note only alphanumeric characters (A-Z, a-z, 0-9) and the “_” underscore character can be used to set the MANU test name.
Syntax	MANU:NAME <string>
Query Syntax	MANU:NAME?
Parameter/ Return parameter	<string> 10 character string. (first character must be a letter)
Example	MANU:NAME test1 Sets the manual test name to “test1”.

<b>MANU:RTIME</b>	
Description	Sets or returns the Ramp Time for the test in seconds.  Note: A “TIME ERR” will result if the Ramp Time + Test Time is ≥ 240 seconds when the HI SET limit

is over 30mA (GPT-98XX) or over 80mA (GPT-99XX/99XXA). This applies to the ACW function only.

Syntax	MANU:RTIMe <NR2>
Query Syntax	MANU:RTIMe?
Parameter/ Return parameter	<NR2> 0.1~999.9 seconds
Example	MANU:RTIM 0.5 Sets the ramp time to half a second.

Set →

→ Query

**MANU:EDIT:MODE**

Description	Sets or returns the mode (ACW, DCW, IR, GB) of the selected manual test.
Syntax	MANU:EDIT:MODE {ACW DCW IR GB}
Query Syntax	MANU:EDIT:MODE?
Parameter/ Return parameter	ACW AC Withstand mode
	DCW DC Withstand mode
	IR Insulation Resistance mode
	GB Ground Bond mode
Example	MANU:EDIT:MODE ACW Sets the mode to ACW.

Set →

→ Query

**MANU:ACW:VOLTage**

Description	Sets or returns the ACW voltage in kV. The test must first be in ACW mode before this command can be used.
Syntax	MANU:ACW:VOLTage <NR2>
Query Syntax	MANU:ACW:VOLTage?
Parameter/ Return parameter	<NR2> 0.100 ~ 5.000 (kV)
Example	MANU:ACW:VOLT 1 Sets the ACW voltage to 1 kV.

**MANU:ACW:CHISet**

Set →

→ Query

**Description**      Sets or returns the ACW HI SET current value in milliamps. The test must first be in ACW mode before this command can be used.

**Syntax**            MANU:ACW:CHISet <NR2>

**Query Syntax**    MANU:ACW:CHISet?

<b>Parameter/</b>	<NR2>	0.001 ~ 042.0 (GPT-98XX)
<b>Return parameter</b>		0.001 ~ 110.0 (GPT-99XX/99XXA)

**Example**            MANU:ACW:CHIS 10.0  
 Sets the ACW HI SET current to 10 mA.

Set →

→ Query

**MANU:ACW:CLOSet**

**Description**      Sets or returns the ACW LO SET current value in milliamps. The LO SET value must be less than the HI SET value. The test must first be in ACW mode before this command can be used.

The LO SET range must use the HI SET range. If all the digits in the LO SET range are outside the HI SET range, an error will be produced. All digits outside the HI SET range are ignored and will not be used.

For example:

HI SET value: 12.34  
 LO SET value1: 0.005 → error  
 LO SET value2: 0.053 → no error

In the example above LO SET value1 will produce an error as all digits are outside the range of HI SET. LO SET value2 will not produce an error, but will return 0.05, not 0.053.

Syntax	MANU:ACW:CLOSet<NR2>
Query Syntax	MANU:ACW:CLOSet?
Parameter/ Return parameter	<NR2> 0.000 ~ 041.9 (GPT-98XX) 0.000 ~ 109.9 (GPT-99XX/99XXA)
Example	MANU:ACW:CLOS 20.0 Sets the ACW LO SET current to 20 mA.

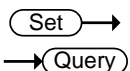

**MANU:ACW:TTIME**

**Description** Sets or returns the ACW test time in seconds. The test must first be in ACW mode before this command can be used.

Note: A “TIME ERR” will result if the Ramp Time + Test Time is  $\geq 240$  seconds when the HI SET limit is over 30mA (GPT-98XX) or over 80mA (GPT-99XX/99XXA). This applies to the ACW function only.

In special MANU mode, the TIMER can be turned off.

Syntax	MANU:ACW:TTIME {<NR2> OFF}
Query Syntax	MANU:ACW:TTIME?
Parameter	<NR2> 0.5 ~ 999.9 seconds OFF TIMER OFF (special MANU mode).
Return parameter	<NR2> 0.5 ~ 999.9 seconds TIME OFF TIMER is OFF (special MANU mode).

**Example** MANU:ACW:TTIM 1  
Sets the ACW test time to 1 second.

**MANU:ACW:FREQuency**

Set →

→ Query

**Description** Sets or returns the ACW test frequency in Hz. The test must first be in ACW mode before this command can be used.

**Syntax** MANU:ACW:FREQuency {50|60}

**Query Syntax** MANU:ACW:FREQuency?

**Parameter/** 50 50 Hz

**Return parameter** 60 60 Hz

**Example** MANU:ACW:FREQ 50

Sets the ACW test frequency to 50Hz.

Set →

→ Query

**MANU:ACW:REF**

**Description** Sets or returns the ACW reference value in mA. The test must first be in ACW mode before this command can be used.

The ACW reference value must be less than the HI SET value.

The ACW reference value must use the same range as the HI SET value.

**Syntax** MANU:ACW:REF <NR2>

**Query Syntax** MANU:ACW:REF?

**Parameter/** <NR2> 0.000 ~ 041.9 (GPT-98XX)

**Return parameter** 0.000 ~ 109.9 (GPT-99XX/99XXA)

**Example** MANU:ACW:REF 0.01

Sets the ACW reference to 0.01 mA.

**MANU:ACW:ARCCurrent**

Set →

→ Query

**Description** Sets or returns the ACW ARC current value in mA. ARC must be enabled before the ARC current can be set. The test must first be in ACW mode before this command can be used.

ARC current uses the same range as the HI SET value. The ARC current is limited to 2X the HI SET value.

**Syntax** MANU:ACW:ARCCurrent <NR2>

**Query Syntax** MANU:ACW:ARCCurrent?

<b>Parameter/</b>	<NR2>	1.000 ~ 080.0 (GPT-98XX)
<b>Return parameter</b>		2.000 ~ 200.0 (GPT-99XX/99XXA)

**Example** MANU:ACW:ARCC 0.04  
Sets the ACW ARC value to 0.04 mA.

Set →

→ Query

**MANU:DCW:VOLTage**

**Description** Sets or returns the DCW voltage in kV. The test must first be in DCW mode before this command can be used.

Note: A “DC Over 50W” error will result if the DCW Voltage X HI SET value is > 50 watts (GPT-98XX).

Note: A “DC Over 100W” error will result if the DCW Voltage X HI SET value is > 100 watts (GPT-99XX/99XXA).

**Syntax** MANU:DCW:VOLTage <NR2>

**Query Syntax** MANU:DCW:VOLTage?

<b>Parameter/</b>	<NR2>	0.100 ~ 6.100 (kV)
<b>Return parameter</b>		

**Example** MANU:DCW:VOLT 6  
Sets the DCW voltage to 6 kV.

**MANU:DCW:CHISet**

Set →

→ Query

**Description** Sets or returns the DCW HI SET current value in milliamps. The test must first be in DCW mode before this command can be used.

Note: A “DC Over 50W” error will result if the DCW Voltage X HI SET value is > 50 watts.

Note: A “DC Over 100W” error will result if the DCW Voltage X HI SET value is > 100 watts (GPT-99XX/99XXA)

**Syntax** MANU:DCW:CHISet <NR2>

**Query Syntax** MANU:DCW:CHISet?

**Parameter/** <NR2> 0.001 ~ 011.0 (GPT-98XX)

**Return parameter** 0.001 ~ 021.0 (GPT-99XX/99XXA)

**Example** MANU:DCW:CHIS 5

Sets the DCW HI SET current to 5mA.

Set →

→ Query

**MANU:DCW:CLOSet**

**Description** Sets or returns the DCW LO SET current value in milliamps. The LO SET value must be less than the HI SET value. The test must first be in DCW mode before this command can be used.

The LO SET range must use the HI SET range. If all the digits in the LO SET range are outside the HI SET range, an error will be produced. All digits outside the HI SET range are ignored and will not be used.

For example:

HI SET value: 12.34

LO SET value1: 0.005 → error

LO SET value2: 0.053 → no error

In the example above LO SET value1 will produce



an error as all digits are outside the range of HI SET. LO SET value2 will not produce an error, but will return 0.05, not 0.053.

Syntax	MANU:DCW:CLOSet<NR2>	
Query Syntax	MANU:DCW:CLOSet?	
Parameter/ Return parameter	<NR2>	0.000 ~ 010.9 (GPT-98XX) 0.000 ~ 020.9 (GPT-99XX/99XXA)
Example	MANU:DCW:CLOS 2.00 Sets the DCW LO SET current to 2mA.	

**MANU:DCW:TTIME**

Set →

→ Query

Description	Sets or returns the DCW test time in seconds. The test must first be in DCW mode before this command can be used.  In special MANU mode, the TIMER can be turned off.	
Syntax	MANU:DCW:TTIME {<NR2> OFF}	
Query Syntax	MANU:DCW:TTIME?	
Parameter	<NR2> OFF	0.5 ~ 999.9 seconds TIMER OFF (special MANU mode).
Return parameter	<NR2> TIME OFF	0.5 ~ 999.9 seconds TIMER is OFF (special MANU mode).

Example            MANU:DCW:TTIM 1  
                       Sets the DCW test time to 1 second.

Set →

**MANU:DCW:REF**

→ Query

Description       Sets or returns the DCW reference value in mA.  
                       The test must first be in DCW mode before this  
                       command can be used.  
                       The reference value must be less than the HI SET  
                       value.  
                       The reference value uses the same range as the HI  
                       SET value.

Syntax             MANU:DCW:REF <NR2>

Query Syntax      MANU:DCW:REF?

Parameter/ Return parameter	<NR2>	0.000 ~ 010.9 (GPT-98XX) 0.000 ~ 020.9 (GPT-99XX/99XXA)
--------------------------------	-------	--

Example            MANU:DCW:REF 0.01  
                       Sets the DCW reference to 0.01 mA.

Set →

**MANU:DCW:ARCCurrent**

→ Query

Description       Sets or returns the DCW ARC current value in mA.  
                       ARC must be enabled to set the ARC current. The  
                       test must first be in DCW mode before this  
                       command can be used.

ARC current uses the same range as the HI SET  
 value. The ARC current is limited to 2X the HI SET  
 value.

Syntax             MANU:DCW:ARCCurrent <NR2>

Query Syntax      MANU:DCW:ARCCurrent?

Parameter/ Return parameter	<NR2>	1.000 ~ 20.00 (GPT-98XX) 2.000 ~ 040.0 (GPT-99XX/99XXA)
--------------------------------	-------	--

Example            MANU:DCW:ARCC 10  
                          Sets the DCW ARC value to 10mA.

Set →

**MANU:IR:VOLTage**

→ Query

Description        Sets or returns the IR voltage in kV. The test must first be in IR mode before this command can be used.

Syntax             MANU:IR:VOLTage <NR2>

Query Syntax      MANU:IR:VOLTage?

Parameter/  
Return parameter   <NR2>    0.05 ~ 1 (0.05kV to 1kV: steps of .05)  
    \*GPT-99XX/99XXA also includes a  
    0.125kV point.

Example            MANU:IR:VOLT 1  
                          Sets the IR voltage to 1 kV.

Set →

**MANU:IR:RHISet**

→ Query

Description        Sets or returns the IR HI SET resistance value in M $\Omega$  (GPT-98XX) or G $\Omega$ . The test must first be in IR mode before this command can be used.

Syntax             MANU:IR:RHISet <NR1>|NULL

Query Syntax      MANU:IR:RHISet?

Parameter/  
Return parameter   <NR1>    GPT-98XX only:  
    2 ~ 9999 (unit = M $\Omega$ )  
    GPT-99XX/GPT-99XXA only:  
    Format A: 0.002 ~ 50.00 (unit = G $\Omega$ )  
    Format B: 0.002G ~ 50.00G  
    Format C: 2M ~ 50000M

                         NULL    Sets the HI SET value to  $\infty$ .

Example            MANU:IR:RHIS 10  
 (GPT-98XX)       Sets the IR HI SET resistance to 10 M $\Omega$ .

Example  
(GPT-99XX/  
99XXA)      MANU:IR:RHIS 0.010  
                 Sets the IR HI SET resistance to 10 MΩ.

Set →

→ Query

**MANU:IR:RLOSet**

Description      Sets or returns the IR LO SET resistance value in MΩ (GPT-98XX) or GΩ. The LO SET value must be less than the HI SET value. The test must first be in IR mode before this command can be used.

Syntax            MANU:IR:RLOSet<NR1>

Query Syntax    MANU:IR:RLOSet?

Parameter/ Return parameter	<b>&lt;NR1&gt;</b>	GPT-98XX only: 1 ~ 9999 (unit = MΩ) GPT-99XX/GPT-99XXA only: Format A: 0.001 ~ 50.00 (unit = GΩ) Format B: 0.001G ~ 50.00G Format C: 1M ~ 50000M
--------------------------------	--------------------	---

Example  
(GPT-98XX)      MANU:IR:RLOS 10  
                 Sets the IR LO SET resistance to 10MΩ.

Example  
(GPT-99XX/  
99XXA)      MANU:IR:RLOS 0.010  
                 Sets the IR LO SET resistance to 10MΩ.

Set →

→ Query

**MANU:IR:TTIME**

Description      Sets or returns the IR test time in seconds. The test must first be in IR mode before this command can be used.

Syntax            MANU:IR:TTIME <NR2>

Query Syntax    MANU:IR:TTIME?

Parameter/ Return parameter	<b>&lt;NR2&gt;</b>	1.0 ~ 999.9 seconds
--------------------------------	--------------------	---------------------

Example            MANU:IR:TTIM 1  
                 Sets the IR test time to 1 second.

Set →

→ Query

**MANU:IR:REF**

**Description** Sets or returns the IR reference value in MΩ (GPT-98XX) or GΩ. The test must first be in IR mode before this command can be used.

The reference value must be lower than the HI SET value.

**Syntax** MANU:IR:REF <NR1>

**Query Syntax** MANU:IR:REF?

**Parameter/Return parameter** <NR1> GPT-98XX only:  
0000 ~ 9999 (unit = MΩ)  
GPT-99XX/GPT-99XXA only:  
Format A: 0 ~ 50.00 (unit = GΩ)  
Format B: 0G ~ 50.00G  
Format C: 0M ~ 50000M

**Example (GPT-98XX)** MANU:IR:REF 900  
Sets the IR reference to 900 MΩ.

**Example (GPT-99XX/99XXA)** MANU:IR:REF 0.900  
Sets the IR reference to 900 MΩ.

Set →

→ Query

**MANU:GB:CURRent**

**Description** Sets or returns the GB current in A. The test must first be in GB mode before this command can be used.

**Syntax** MANU:GB:CURRent <NR2>

**Query Syntax** MANU:GB:CURRent?

**Parameter/Return parameter** <NR2> 3.00~33.00 (GPT-98XX)  
3.00~33.00 (GPT-99XX)

**Example** MANU:GB:CURR 3.00  
Sets the GB current to 3.00A.

Set →

**MANU:GB:RHISet**

→ Query

Description	Sets or returns the GB HI SET resistance value in mΩ. The test must first be in GB mode before this command can be used.
Syntax	MANU:GB:RHISet <NR2>
Query Syntax	MANU:GB:RHISet?
Parameter/ Return parameter	<NR2> 000.1 ~ 650.0
Example	MANU:GB:RHIS 100.0 Sets the HI SET value to 100mΩ.



Note

If the (GB current x HI SET resistance) > 5.4V, then an error will be generated (“GBV > 5.4V”).

Set →

**MANU:GB:RLOSet**

→ Query

Description	Sets or returns the GB LO SET resistance value in mΩ. The LO SET value must be less than the HI SET value. The test must first be in GB mode before this command can be used.
Syntax	MANU:GB:RLOSet<NR2>
Query Syntax	MANU:IR:RLOSet?
Parameter/ Return parameter	<NR2> 0.000 ~ 649.9
Example	MANU:GB:RLOS 50 Sets the GB LO SET resistance to 50mΩ.

Set →

**MANU:GB:TTIME**

→ Query

Description	Sets or returns the GB test time in seconds. The test must first be in GB mode before this command can be used.
-------------	---

Syntax	MANU:GB:TTIME <NR2>
Query Syntax	MANU:GB:TTIME?
Parameter/ Return parameter	<NR2> 0.5 ~ 999.9 seconds
Example	MANU:GB:TTIM 1 Sets the GB test time to 1 second.

Set →

→ Query

### MANU:GB:FREQUENCY

Description	Sets or returns the GB test frequency in Hz. The test must first be in GB mode before this command can be used.
Syntax	MANU:GB:FREQUENCY {50 60}
Query Syntax	MANU:GB:FREQUENCY?
Parameter/ Return parameter	50 50 Hz 60 60 Hz
Example	MANU:GB:FREQ 50 Sets the GB test frequency to 50Hz.

Set →

→ Query

### MANU:GB:REF

Description	Sets or returns the GB reference value in mΩ. The test must first be in GB mode before this command can be used.  The GB reference value must be less than the HI SET value.
Syntax	MANU:GB:REF <NR2>
Query Syntax	MANU:GB:REF?
Parameter/ Return parameter	<NR2> 0.000 ~ 649.9
Example	MANU:GB:REF 100 Sets the GB reference to 100 mΩ.

Set →

→ Query

**MANU:GB:ZEROCHECK**

**Description** Performs the zero check function. The test must first be in GB mode and in the Ready Status before this command can be used.

See page 73 for details on the ZERO function.

**Syntax** MANU:GB:ZEROCHECK {ON|OFF}

**Query Syntax** MANU:GB:ZEROCHECK?

<b>Parameter/</b>	ON	Zero function is active.
<b>Return parameter</b>	OFF	Zero function is not active.

**Example** MANU:GB:ZEROCHECK OFF  
 Activates the ZERO function.

Set →

→ Query

**MANU:UTILity:ARCMODE**

**Description** Sets or returns the ARC mode status for the current test.  
 The ARC mode cannot be set for the IR and GB function.

**Syntax** MANU:UTILity:ARCMODE {OFF|ON\_CONT|ON\_STOP}

**Query Syntax** MANU:UTILity:ARCMODE?

<b>Parameter/</b>	OFF	Turns ARC mode off.
<b>Return parameter</b>	ON_CONT	Sets ARC mode to ON and CONTINUE.
	ON_STOP	Sets ARC mode to ON and STOP.

**Example** MANU:UTIL:ARCM OFF  
 Turns ARC mode OFF.



## MANU:UTILity:PASShold

**Description** Sets or returns the PASS HOLD setting for the current test.

**Syntax** MANU:UTILity:PASShold {ON|OFF}

**Query Syntax** MANU:UTILity:PASShold?

**Parameter/** OFF Turns PASS HOLD off.

**Return parameter** ON Turns PASS HOLD on.

**Example** MANU:UTIL:PASS OFF  
Turns PASS HOLD OFF.

## MANU:UTILity:FAILmode

**Description** Sets or returns the FAIL mode setting for the current test.

**Syntax** MANU:UTILity:FAILmode {CONT|HOLD|STOP}

**Query Syntax** MANU:UTILity:FAILmode?

**Parameter/** CONT Sets/returns the fail mode as continue.

**Return parameter** HOLD Sets/returns the fail mode as hold.

STOP Sets/returns the fail mode as stop.

**Example** MANU:UTIL:FAIL CONT  
Sets the fail mode to CONT (continue).

## MANU:UTILity:MAXHold

**Description** Sets or returns the MAX HOLD setting for the current test.

**Syntax** MANU:UTILity:MAXHold {ON|OFF}

**Query Syntax** MANU:UTILity:MAXHold?

**Parameter/** OFF Turns MAX HOLD off.

**Return parameter** ON Turns MAX HOLD on.

Example            MANU:UTIL:MAXH ON  
                          Turns MAX HOLD on.

Set →

**MANU:UTILity:GROUNDMODE**

← Query

Description       Sets or returns the Grounding mode of the current test.  
                          The Ground Mode setting cannot be turned on with the IR and GB function.

Syntax            MANU:UTILity:GROUNDMODE {ON|OFF}

Query Syntax     MANU:UTILity:GROUNDMODE?

Parameter/       OFF            Turns ground mode off.

Return parameter ON            Turns ground mode on.

Example           MANU:UTIL:GROUNDMODE ON  
                          Turns GROUND MODE on.

**MANU<x>:EDIT:SHOW**

← Query

Description       Returns the test parameters of a manual test.

Query Syntax     MANU<x>:EDIT:SHOW?

Parameter/       <x>            <NR1> 000~100. Manual test number

Return parameter <string>      Returns a string in the following format:  
                          Test function, test voltage, HI SET value, LO SET value, Ramp time, test time.

Example           MANU1:EDIT:SHOW ?  
                          > ACW,0.100kV,H=01.00mA,L=00.00mA,R=000.1S,  
                          >T=001.0S.  
                          Returns the test parameters of manual test number 1.

## Sweep Commands

SWEEP:DATA:STATus.....	147
SWEEP<X>:DATA:SHOW.....	148
SWEEP:GRAPh:SHOW.....	149
SWEEP :GRAPh:LINE.....	149
SWEEP:STARt:TIME.....	150

### SWEEP:DATA:STATus

→ Query

Description	<p>Returns the sweep mode, the voltage and current settings and the number data points that are used in the last sweep. There can be a maximum of 190 data points, depending on the testing time.</p> <p>The data is returned as a string in the following format:</p> <p>SWEEP MODE,VSET,ISET,Get Data[#data points].</p>
Query Syntax	SWEEP:DATA:STATus?
Return parameter	<string> SWEEP MODE, VSET+unit, ISET+units, Get Data=number of data points
Example	<p>SWEEP:DATA:STATus?</p> <p>&gt;ACW,V=0.108kV,HI=10.96 mA ,Get Data=011</p>

**SWEEP<X>:DATA:SHOW**

→ **Query**

**Description** Returns the data associated with a sweep graph. Data can be returned in one of two ways; either all the data can be returned or only the data at a particular point in time. The test points are evenly distributed. There can be up to 190 data points.

If only the data from a single point is returned then the data is returned in the following format\*:  
 DATA POINT, VSET, ISET, TIME, CR+LF

If the all the data for the all the points is returned then the data is returned in the following format\*:

```
ACW MODE,CR+LF
No.,V(kV),I(mA), T(S) ,CR+LF
001,0.071,0.032,0000.1,CR+LF
002,0.111,0.047,0000.2,CR+LF
.....
013,0.601,0.215,0001.3,CR+LF
END
```

\*Where CR+LF is a carriage return and line feed code. Time is in seconds.

<b>Query Syntax</b>	SWEEP<X>:DATA:SHOW?	
<b>Parameter</b>	<X>	<NR1> 1~190 (single data point)
	<X>	<NR1> 0 (all data points)

**Single Data Point Example** SWEEP10:DATA:SHOW?  
 > 010,0.106,00.00,0001.0, CR+LF

Returns the data at point 10, which is at the 1 second time for the sweep test.

All Data Points      SWEEP0:DATA:SHOW?  
 Example              >ACW MODE,CR+LF  
                          >No.,V(kV),I(mA), T(S) ,CR+LF  
                          >001,0.071,0.032,0000.1,CR+LF  
                          >002,0.111,0.047,0000.2,CR+LF  
                          >.....  
                          >013,0.601,0.215,0001.3,CR+LF  
                          >END

This will return all the data from the sweep graph.

Set →

→ Query

**SWEEP:GRAPh:SHOW**

Description      Turns the sweep graph on or off on the GPT-99XX/99XXA display.

Syntax              SWEEP:GRAPh:SHOW {ON|OFF}

Query Syntax      SWEEP:GRAPh:SHOW?

Parameter/ Return parameter	ON	Turn the sweep graph on.
	OFF	Turn the sweep graph off.

Example              SWEEP:GRAP:SHOW ON  
 Displays the sweep graph on the LCD display.

Set →

→ Query

**SWEEP :GRAPh:LINE**

Description      Sets or returns which lines are shown on the sweep graph.

Syntax              SWEEP:GRAPh:LINE <NR1>

Query Syntax      SWEEP:GRAPh:LINE?

Parameter/ Return parameter	<NR1>	Description
	0	Turn all lines off/all lines are off.
	1	Displays the graph line for the primary test item. See page 77 for details.  For example: V for ACW, DCW and IR tests, I for GB tests.
	2	Displays the graph line for the secondary test items.  For example: I for ACW and DCW tests, R for IR and GB tests.
	3	Turn all lines on/all lines are on.

Example SWEEP:GRAP:LINE 3  
Turns all the graph lines on.

Set →

**SWEEP:START:TIME**

→ Query

Description Sets or returns the start time (STA.t) of the sweep graph in milliseconds.  
  
This setting will also set what the time will be for the first point for the sweep data that is returned in the SWEEP:DATA:SHOW query.

Syntax	SWEEP:START:TIME <NR2>	
Query Syntax	SWEEP:START:TIME ?	
Parameter/ Return parameter	<NR2>	0.1~1999.8 seconds

Example SWEEP:START:TIME 1000.0  
Sets the sweep start time to 1000 seconds.

## Auto Commands

AUTO<x>:PAGE:SHOW ..... 152  
 AUTO:PAGE:MOVE ..... 152  
 AUTO:PAGE:SWAP ..... 153  
 AUTO:PAGE:SKIP ..... 153  
 AUTO:PAGE:DEL ..... 154  
 AUTO:NAME ..... 154  
 AUTO:EDIT:ADD ..... 155  
 TESTok:RETurn ..... 155

### AUTO:STEP

Set →

→ Query

Description	Sets or queries the AUTO number (automatic test number).
Syntax	AUTO:STEP <NR1>
Query Syntax	AUTO:STEP?
Parameter/ Return parameter	<NR1> 1~100.
Example	AUTO:STEP 100 Sets the current AUTO number to 100.

**AUTO<x>:PAGE:SHOW** → Query

Description	Returns the Page View of the selected automatic test in the following format: step1:MANU number, step2: MANU number, step3....etc.
Query Syntax	AUTO<x>:PAGE:SHOW?
Parameter/	<x> <NR1> 1~100
Example	AUTO1:PAGE:SHOW?  >01:011 ,02:004 ,03:003 ,04:014 , >05:015 ,06:020* ,07:012 ,08:018 , >09: ,10: ,11: ,12: , >13: ,14: ,15: ,16: ,  Shows the Page View for AUTO number 1.

**AUTO:PAGE:MOVE** Set →

Description	Moves the source step to the desired destination.
Syntax	AUTO:PAGE:MOVE <Value1>,<Value2>
Parameter/	<Value1> <NR1> 1~16 (source step) <Value2> <NR1> 1~16 (destination step)
Example	AUTO:PAGE:MOVE 1, 4  Moves the contents of step 1 to the step 4.

```

AUTO=001-010 AUTO_NAME
MANU_NAME ACW=0-100kV-HI SET=01 10mA
#01:010 ← #02:001 ← #03:003 ← #04:004
#05:007 #06:003 #07:038 #08:005
#09: #10: #11: #12:
#13: #14: #15: #16:
MOVE SWAP SKIP DEL
    
```



## AUTO:PAGE:SWAP

Set →

Description	Swaps the source step with destination step.
Syntax	AUTO:PAGE:SWAP <Value1>,<Value2>
Parameter/	<Value1> <NR1> 1~16 (source step) <Value2> <NR1> 1~16 (destination step)
Example	AUTO:PAGE:SWAP 1, 4 Swaps the contents of step 1 with step 4.

```

AUTO=001-010 AUTO_NAME
MANU_NAME ACW=0.100kV HI_SET=01.00mA
#01:010 #02:001 #03:003 #04:004
#05:007 #06:003 #07:038 #08:005
#09: #10: #11: #12:
#13: #14: #15: #16:
MOVE SWAP SKIP DEL
    
```

## AUTO:PAGE:SKIP

Set →

Description	Skips the selected step when an AUTO test is run. This is shown as an asterisk (*) when in the PAGE view.
Syntax	AUTO:PAGE:SKIP <NR1>,{ON OFF}
Parameter/	<NR1> 1~16 (step no.#) ON Skip the selected step. OFF Un-skip the selected step.

Example AUTO:PAGE:SKIP 1,ON  
Skips step number #1.

```

AUTO=001-010 AUTO_NAME
MANU_NAME ACW=0.100kV HI_SET=01.00mA
#01:010* #02:001 #03:003 #04:004
#05:007 #06:003 #07:038 #08:005
#09: #10: #11: #12:
#13: #14: #15: #16:
MOVE SWAP SKIP DEL
    
```

## AUTO:PAGE:DEL

Set →

**Description** Deletes the selected step from the AUTO test. The remaining steps move up to replace the deleted step.

**Syntax** AUTO:PAGE:DEL <NR1>

**Parameter/** <NR1> 1~16 (step no.#)

**Example** AUTO:PAGE:DEL 3

Deletes the contents of step number #3.

```

AUTO=001-010 AUTO_NAME
MANU_NAME ACW=0.100kV-HI SET=01.00mA
#01:010 #02:001 (#03:003) ← (#04:004)
#05:007 #06:003 #07:038 #08:005
#09: #10: #11: #12:
#13: #14: #15: #16:
MOVE SWAP SKIP DEL
    
```

Set →

## AUTO:NAME

→ Query

**Description** Sets or returns the AUTO name for the selected automatic test. The test must be in AUTO mode before this command can be used.

Note only alphanumeric characters (A-Z, a-z, 0-9) and the “\_” underscore character can be used to set the AUTO test name.

**Syntax** AUTO:NAME <string>

**Query Syntax** AUTO:NAME?

**Parameter/** <string> 10 character string. (first character must  
**Return parameter** be a letter)

**Example** AUTO:NAME program1

Sets the AUTO name to “program1”.

**AUTO:EDIT:ADD**

Set →

**Description** Add the selected MANU test to the current AUTO number.

**Syntax** AUTO:EDIT:ADD <NR1>

**Parameter/** <NR1> 1~100

**Example** AUTO:EDIT:ADD 7

Adds MANU-007 to the current AUTO number. I.e.,

```
AUTO=005-007 AUTO_NAME
MANU_NAME ACW=0.100kV HI SET=01.00mA
#01:010 #02:001 #03:003 #04:004
#05:007 #06: #07: #08:
#09: #10: #11: #12:
#13: #14: #15: #16:
MOV= SWAP SKIP DEL
```

MANU test added to last step

Set →

**TESTok:RETurn**

→ Query

**Description** Allows “OK” to be displayed on the remote terminal when a test has stopped (PASS/FAIL or STOP). This applies for MANU and AUTO mode.

By default, TESTok:RETurn is set to OFF.

**Syntax** TESTok:RETurn {ON|OFF}

**Query Syntax** TESTok:RETurn?

**Parameter/** ON Enables the “OK” message to be displayed.

**Return parameter** OFF Disables the message

**Example** TEST:RET OFF

Disables the message.

**\*SRE**



Description	AUTO MODE only. Use this command to get measurement step number at the current point in time during AUTO MODE testing.  Example: User send command “*SRE” to GPT-9000 during AUTO mode
Query Syntax	*SRE?
Return parameter	<NR1> 00~16
Example	*SRE?  >5  The current test step is number 5. This indicates that steps 1~4 have already been completed and the results for those steps can now be retrieved.

## Common Commands

\*CLS..... **Error! Bookmark not defined.**

\*IDN ..... **Error! Bookmark not defined.**

\*CLS

Set →

Description      The \*CLS command clears the internal registers.

Syntax            \*CLS

\*IDN

→ Query

Description      Queries the model number, serial number, and firmware version of the tester.

Query Syntax     \*IDN?

Return parameter <string> Returns the instrument identification as a string in the following format:

GPT-9803,XXXXXXXXXXXX, V1.00

Model number : GPT-9803

Serial number :12 character serial number

Firmware version : V1.00

## Remote Commands

\*RMTOFF..... 158

### \*RMTOFF



**Description** This command can be used to terminate a remote session. When this command is used “RMT” will no longer be displayed on the front panel, indicating that remote mode has been terminated.

**Syntax** \*RMTOFF

## Special Functions

Inter Lock Key Open ..... 158

### Inter Lock Key Open



**Description** This special function is not a command. When in remote mode, the GPT-9000 will send the message, “Inter Lock Key Open” if a test is started with INTERLOCK set to ON, but the interlock signal I/O pins are not shorted (either with the included interlock key or manually).

This special function is analogous to the “INTERLOCK OPEN” message that is displayed on the front panel under the same conditions (page 104).

## Error Messages

---

Background      The possible error messages returned from SYST:ERR? query are listed below.

Error	Error Code
Command Error	0x14
Value Setting Error	0x15
String Setting Error	0x16
Query Error	0x17
MODE Setting Error	0x18
Time Error	0x19
DC Over 50W (GPT-98XX only)	0x1A
DC Over 100W (GPT-99XX/99XXA only)	0x1A
GBV > 5.4V	0x1B

# FAQ

---

- The tester will not turn on.
- The panel keys are not working.
- When I press the START button the tester will not start testing?
- The accuracy does not match the specification.

## The tester will not turn on.

---

Ensure the power cord is connected. Ensure the line input is set to the correct line voltage. Check to make sure the fuse is not blown. See page 162.

## The panel keys are not working.

---

Ensure the tester is not in remote mode, page 116.

Ensure the tester is not in SIGNAL I/O or Remote Connect mode, page 102.

## When I press the START button the tester will not start testing?

---

The tester must first be in the READY status before a test can be started. Ensure the tester displays READY before pressing the START button, page 64 (manual test), 90(automatic test).

If “Double Action” is enabled, the START button must be pressed 0.5 seconds after the STOP button is pressed, otherwise the tester will not start testing.



If “Interlock” is enabled, the interlock key must be inserted into the signal I/O port on the rear before a test can be started. See page 110 for details.

Lastly, ensure that the Start Ctrl setting is correctly configured in the Common Utility menu. For example, to enable the START button to start a test, ensure that the Start Ctrl setting is set to FRONT PANEL. See page 102 for details.

The accuracy does not match the specification.

---

Make sure the tester is powered on for at least 30 minutes, within +15°C~+35°C. This is necessary to stabilize the unit to match the specification.

For more information, contact your local dealer or GWInstek at [www.gwinstek.com](http://www.gwinstek.com) / [marketing@goodwill.com.tw](mailto:marketing@goodwill.com.tw).

# APPENDIX

## Fuse Replacement

---

Steps

1. Turn the instrument off.

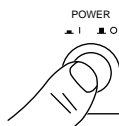

2. Remove the power cord.

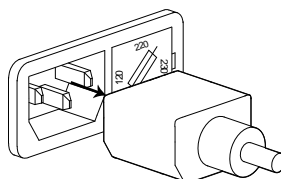

3. Remove the fuse socket using a flat screwdriver.

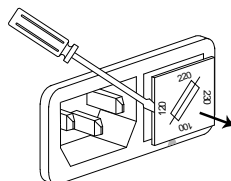

4. Replace the fuse in the fuse holder.

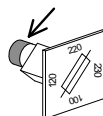

5. Ensure the correct line voltage is lined up with the arrow on the fuse holder. Insert the fuse socket.

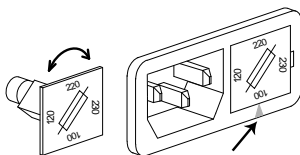

**Rating**

The fuse for the GPT-98XX and the GPT-99XX/99XXA have different ratings:

**GPT-98XX:**

100V/120V	T5A 250V
220V/230V	T2.5A 250V

**GPT-99XX/99XXA:**

100V/120V	T10A 250V
220V/230V	T6.3A 250V

## Error Messages

### System Self Test

The following error messages or messages may appear on the GPT screen during the Start-Up initialization. If any of these error messages appear on the GPT-9000/9000A, please see an authorized GW Instek distributor.

Error Messages	Description
0x11	EEPROM1 Error
0x12	EEPROM1 Error
0x21	W-V Offset Error (W-V: ACW/DCW voltage)
0x22	W-I Offset Error (W-I: ACW/DCW current)
0x23	IR-I Offset Error
0x24	GB-I Offset Error

## Test Errors

The following error messages or messages may appear on the GPT screen when configuring or running tests.

Error Messages	Description
TIME ERR	For ACW tests. GPT-98XX: TIME ERR is displayed when HI SET $\geq$ 30.00mA~40.00mA and if the RAMP $\uparrow$ time and the TEST TIME setting is $>$ 240 seconds. GPT-99XX/99XXA: TIME ERR is displayed when HI SET $\geq$ 80.00mA~100.0mA and if the RAMP $\uparrow$ time and the TEST TIME setting is $>$ 240 seconds.
OVER 50W (GPT-98XX)	For DCW tests. OVER 50W is displayed if the HI SET setting multiplied by the Voltage setting is greater than 50W (GPT-98XX only).
OVER 100W (GPT-99XX/99XXA)	For DCW tests. OVER 100W is displayed if the HI SET setting multiplied by the Voltage setting is greater than 100W (GPT-99XX/99XXA only).
I ERR	For ACW, DCW tests. Shown when the current is set too high.
SHORT	Voltage is too low or there is no High Voltage output. Indicates that the DUT could be shorted.
V ERR	For ACW, DCW tests. Indicates that an abnormal voltage has been detected.
V = 0	For GB tests. Voltage is equal to 0. Check to see that the SENSE H or SOURCE H is not open.
R ERR	For IR tests. The voltage is too high or resistance=0 $\Omega$ . Check to see whether the DUT or test lead is shorting.  For GB tests. The resistance is too high.

---

I<SET	For GB tests. Current too low. Indicates that the SOURCE L or SOURCE H test lead is open or poorly connected. Test the test lead connection with the DUT to confirm.
I>SET	For GB tests. Current is too high.
R=0	For GB tests. Resistance = 0. This error indicates that there is an error with the measured resistance ( $0\Omega$ ). Perform the zeroing function again.
GBV OVER	GBV > 5.4V

---

## GPT-9000/9000A Specifications

The specifications apply when the GPT-9000/9000A is powered on for at least 30 minutes at 15°C~35°C.

### Specifications

#### Environment

Range	Temperature	Humidity
Warranty	15°C ~ 35°C	≤70% (No condensation)
Operation	0°C ~ 40°C	≤70% (No condensation)
Storage	-10°C ~ 70°C	≤85% (No condensation)
Installation Location	Indoors at an amplitude of up to 2000m.	

#### AC Withstanding Voltage

Output Voltage Range	0.100kV~ 5.000kV
Output Voltage Resolution	2V
Output Voltage Accuracy	± (1% of setting +5V) with no load
Maximum Rated Load(Table1)	200 VA (5kV/40mA) [GPT-98XX] 500 VA (5kV/100mA) [GPT-99XX/99XXA]
Maximum Rated Current	40mA [GPT-98XX], 100mA [GPT-99XX/99XXA] 0.001mA ~ 10mA(0.1kV≤V≤0.5kV) 0.001mA ~ 40mA(0.5kV<V≤5kV) [GPT-98XX] 0.001mA ~ 100mA(0.5kV<V≤5kV) [GPT-99XX/99XXA]
Output Voltage Waveform	Sine wave
Frequency	50 Hz / 60 Hz
Voltage Regulation	± 1% +5V [Maximum rated load → no load]
Voltmeter Accuracy	± (1% of reading+ 5V)
Current Measurement Range	0.001mA~040.0mA [GPT-98XX] 0.001mA~100.0mA [GPT-99XX/GPT-99XXA]

Continued...

Current Best Resolution	GPT-98XX: 1 $\mu$ A 0.001mA(0.001mA~0.999mA) 0.01mA(01.00mA~09.99mA) 0.1mA(010.0~040.0mA)  GPT-99XX/GPT-99XXA: 1 $\mu$ A 0.001mA(0.001mA~1.100mA) 0.01mA(01.11mA~11.00mA) 0.1mA(011.1~100.0mA)
Current Measurement Accuracy	GPT-98XX: $\pm$ (1.5% of rdg + 30 counts) when HI SET<1.00mA $\pm$ (1.5% of rdg + 3 counts) when HI SET $\geq$ 1.00mA  GPT-99XX/GPT-99XXA: $\pm$ (1.5% of rdg + 30 counts) when HI SET<1.11mA $\pm$ (1.5% of rdg + 3 counts) when HI SET $\geq$ 1.11mA
Window Comparator Method	Yes
ARC DETECT	Yes
Rise-time Control Function	Yes
RAMP (Ramp Time)	0.1~999.9S
TIMER (Test Time)	OFF*, 0.5S~999.9S
GND	ON/OFF
* The timer can only be turned off under special MANU mode (MANU=***-000)	

**DC Withstanding Voltage**

Output Voltage Range	0.100kV~ 6.000kV
Output Voltage Resolution	2V
Output Voltage Accuracy	$\pm$ (1% of setting +5V) with no load
Maximum Rated Load(Table1)	50W (5kV/10mA)[GPT-98XX] 100W (5kV/20mA)[GPT-99XX/99XXA]
Maximum Rated Current	10mA [GPT-98XX, 20mA [GPT-99XX/99XXA] 0.001mA ~ 2mA (0.1kV $\leq$ V $\leq$ 0.5kV) 0.001mA ~ 10mA (0.5kV<V $\leq$ 6kV)[GPT-98XX] 0.001mA ~ 20mA (0.5kV<V $\leq$ 6kV)[GPT-99XX/ 99XXA]
Voltmeter Accuracy	$\pm$ (1% of reading+ 5V)
Voltage Regulation	$\pm$ 1% +5V [Maximum rated load $\rightarrow$ no load]
Current Measurement Range	0.001mA~010.0mA [GPT-98XX] 0.001mA~020.0mA [GPT-99XX/99XXA]

Continued...

Current Best Resolution	GPT-98XX: 1uA 0.001mA(0.001mA~0.999mA) 0.01mA(01.00mA~09.99mA) 0.1mA(010.0mA)
	GPT-99XX/99XXA: 1uA 0.001mA(0.001mA~1.100mA) 0.01mA(01.11mA~11.00mA) 0.1mA(011.0mA~020.0mA)
Current Measurement Accuracy	GPT-98XX: ± (1.5% of rdg + 30 counts) when HI SET <1.00mA (1.5% of rdg + 3 counts) when HI SET ≥1.00mA
	GPT-99XX/99XXA: ± (1.5% of rdg + 30 counts) when HI SET <1.11mA (1.5% of rdg + 3 counts) when HI SET ≥1.11mA
Window Comparator Method	Yes
ARC DETECT	Yes
Rise-time Control Function	Yes
RAMP (Ramp Time)	0.1~999.9S
TIMER (Test Time)	OFF*, 0.5S~999.9S
GND	ON/OFF
* The timer can only be turned off under special MANU mode (MANU=***.000)	

**Insulation Resistance Test**

Output Voltage	50V~1000V *GPT-99XX/99XXA also includes a 125V test point.	
Output Voltage Resolution	50V	
Output Voltage Accuracy	(1% of setting+5V) with no load	
Resistance Measurement Range	1MΩ~ 9500MΩ (GPT-98XX)	
Test Voltage	Measurement Range	Accuracy
(GPT-98XX)	50V≤V≤450V	1~50MΩ ±(5% of reading +1 count) 51~2000MΩ ±(10% of reading +1 count)
	500V≤V≤1000V	1~500MΩ ±(5% of reading +1 count) 501~9500MΩ ±(10% of reading +1 count)
(GPT-99XX/99XXA)	50V≤V≤450V	0.001~0.050GΩ ±(5% of reading +1 count) 0.051~2.000GΩ ±(10% of reading +1 count)
	500V≤V≤1000V	0.001~0.500GΩ ±(5% of reading +1 count)
		0.501~9.999GΩ ±(10% of reading +1 count)
		10.00~50.00GΩ ±(15% of reading +1 count)



Continued...

Output Impedance	600kΩ
Window Comparator Method	Yes
Rise-time Control Function	Yes
RAMP (Ramp Time)	0.1~999.9S
TIMER (Test Time)	1S~999.9S
GND	OFF

**Ground Bond Test**

Output Current Range	03.00A~30.00A (GPT-98XX) 03.00A~32.00A (GPT-99XX)
Output Current Accuracy	± (1% of reading +0.2A) when 3A<math>I\leq 8A</math> ± (1% of reading +0.05A) when 8A<math>I\leq 30A</math> (GPT-98XX) ± (1% of reading +0.05A) when 8A<math>I\leq 32A</math> (GPT-99XX)
Output Current Resolution	0.01A
Frequency	50Hz/60Hz selectable
Ohmmeter Measurement Accuracy	± (1% of reading +2mΩ)
Ohmmeter Measurement Range	10mΩ~650.0mΩ (depending on output current)

GPT-98XX:

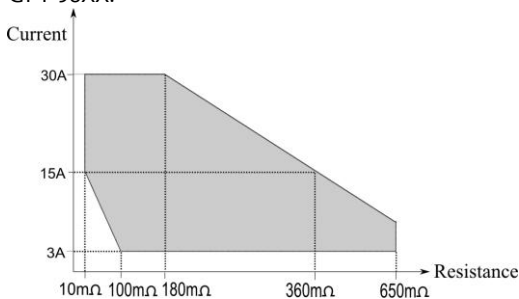

Continued...

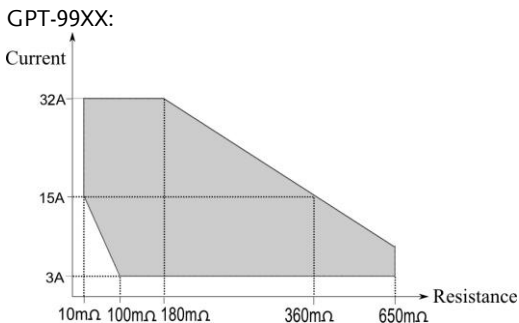

Test Voltage	Max. 6V(AC) open-circuit
Ohmmeter Measurement Resolution	0.1 mΩ
Windows Comparator Method	Yes
TIMER (Test Time)	0.5S~999.9S
GND	OFF

**Interface**

REMOTE (Remote terminal)	Yes
SIGNAL IO	Yes
RS232	Yes
USB (Device)	Yes
GPIB	Yes (OPTION)

**General**

DISPLAY	240 x 64 dot matrix LED back light LCD
MEMORY	AUTO/MANU mode 100 memory blocks total
POWER SOURCE	AC100V/120V/220V/230V ±10% 50Hz/60Hz
ACCESSORIES	Power cord x1, Quick Start Guide x1 User Manual x1 (CD) GHT-114x1 for GPT-9801/9802/9803/9901A/ 9902A/9903/9903A GHT-114x1, GTL-115x1 for GTP-9804/9904
DIMENSIONS & WEIGHT	GPT-98XX: Approx. 330(W) x 148(H) x 452(D) mm (Max.), 19kg(Max) GPT-99XX: Approx. 330(W) x 148(H) x 587(D) mm (Max.), 27kg(Max) GPT-99XXA: Approx. 330(W) x 148(H) x 482(D) mm(Max), 24kg(Max)

Continued...

**Table 1a: Output Limitation in Withstanding Voltage Testing (GPT-98XX)**

	Upper Current	Pause	Output Time
AC	$30\text{mA} \leq I \leq 40\text{mA}$	At least as long as the output time	Maximum 240 seconds
	$0.001\text{mA} \leq I < 30\text{mA}$	Not necessary	Continuous output possible
DC	$0.001\text{mA} \leq I \leq 10\text{mA}$	Not necessary	Continuous output possible
GB	$15\text{A} < I \leq 30\text{A}$	At least as long as the output time	999.9
	$3\text{A} \leq I \leq 15\text{A}$	Not necessary	999.9

NOTE: Output Time = Ramp Time + Test Time.

**Table 1b: Output Limitation in Withstanding Voltage Testing (GPT-99XX/99XXA)**

	Upper Current	Pause	Output Time
AC	$80\text{mA} \leq I \leq 100\text{mA}$	At least as long as the output time	Maximum 240 seconds
	$0.001\text{mA} \leq I < 80\text{mA}$	Not necessary	Continuous output possible
DC	$0.001\text{mA} \leq I \leq 20\text{mA}$	Not necessary	Continuous output possible
GB	$15\text{A} < I \leq 32\text{A}$ (99XX)	At least as long as the output time	999.9
	$3\text{A} \leq I \leq 15\text{A}$	Not necessary	999.9

NOTE: Output Time = Ramp Time + Test Time.

## GPT-9801/9802/9803 Dimensions

---

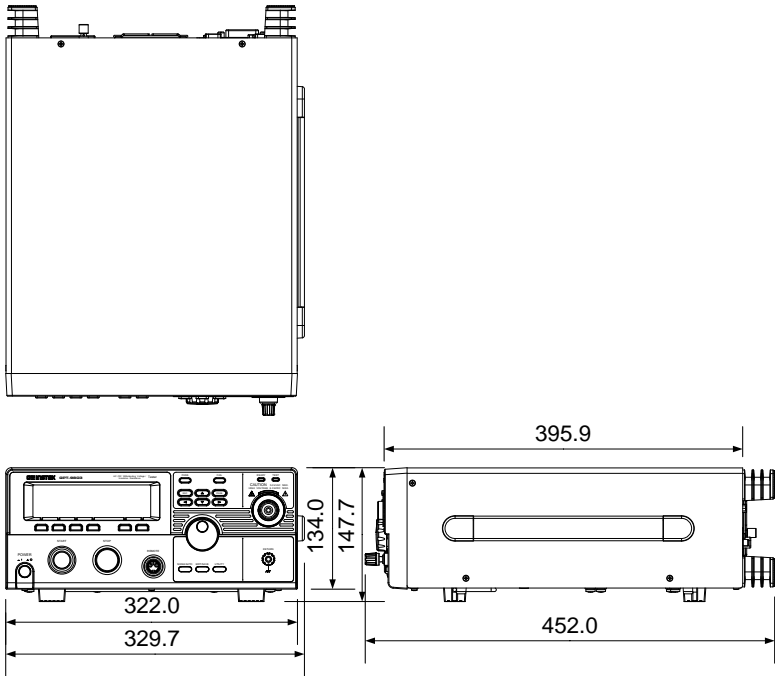

# GPT-9804 Dimensions

---

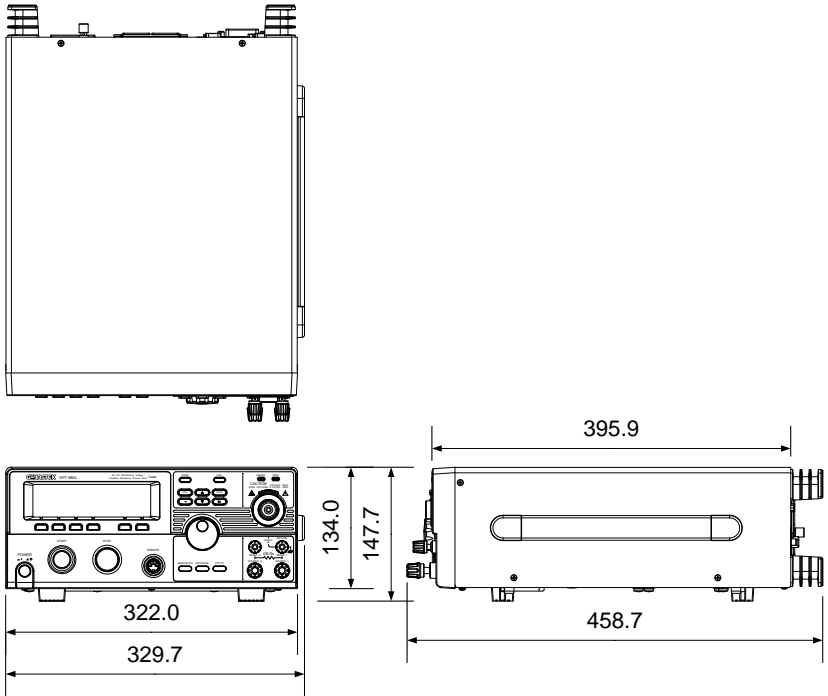

## GPT-9903 Dimensions

---

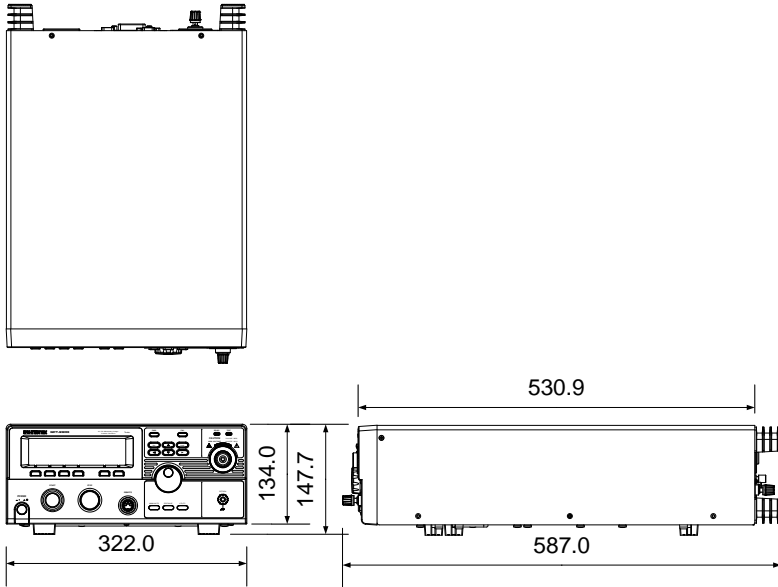

## GPT-9904 Dimensions

---

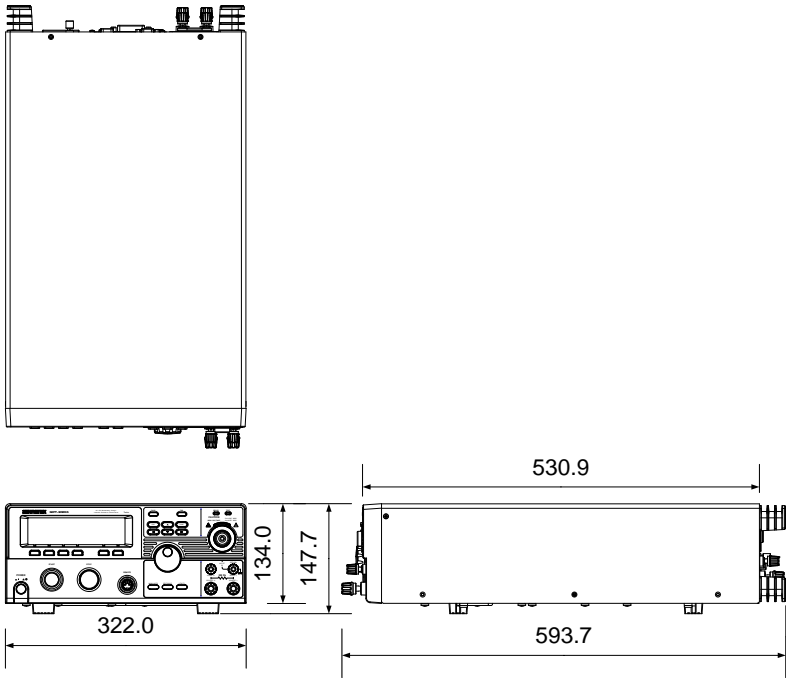

## GPT-9901A/9902A/9903A Dimensions

---

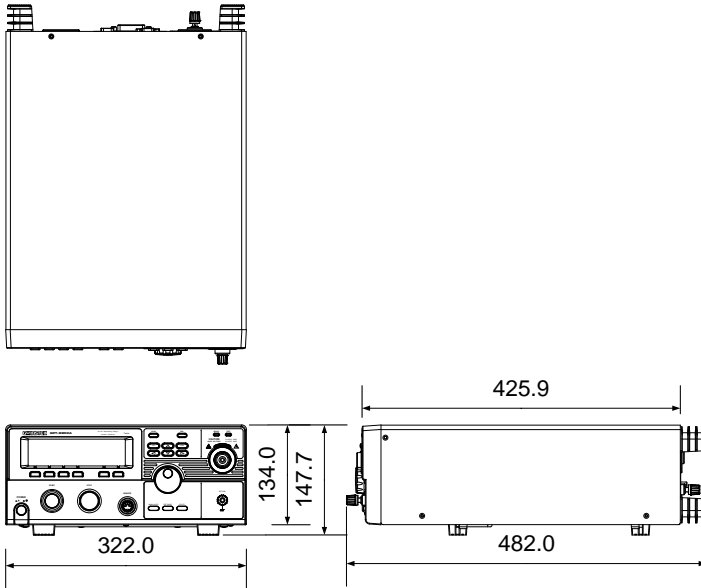



# Declaration of Conformity

We

**GOOD WILL INSTRUMENT CO., LTD.**

No. 7-1, Jhongsing Rd, Tucheng Dist., New Taipei City 236, Taiwan

**GOOD WILL INSTRUMENT (SUZHOU) CO., LTD.**

No. 69 Lushan Road, Suzhou New District Jiangsu, China.

declare that the below mentioned product

**Type of Product: Electrical Safety Tester**

**Model Number:** GPT-9801, GPT-9802, GPT-9803, GPT-9804, GPT-9901A, GPT-9902A, GPT-9903, GPT-9903A, GPT-9904

are herewith confirmed to comply with the requirements set out in the Council Directive on the Approximation of the Law of Member States relating to Electromagnetic Compatibility (2004/108/EC) and Low Voltage Directive (2006/95/EC).

For the evaluation regarding the Electromagnetic Compatibility and Low Voltage Directive, the following standards were applied:

◎ EMC	
EN 61326-1 EN 61326-2-1	Electrical equipment for measurement, control and laboratory use -- EMC requirements (2013)
Conducted Emission Radiated Emission EN55011: 2009+A1: 2010	Electrostatic Discharge EN 61000-4-2: 2009
	Radiated Immunity EN 61000-4-3: 2006 +A2:2010
Current Harmonics EN 61000-3-2: 2006+A1:2009 +A2:2009	Electrical Fast Transients EN 61000-4-4: 2012
	Surge Immunity EN 61000-4-5: 2006
Voltage Fluctuations EN 61000-3-3: 2008	Conducted Susceptibility EN 61000-4-6: 2009
-----	Power Frequency Magnetic Field EN 61000-4-8: 2010
-----	Voltage Dip/ Interruption EN 61000-4-11: 2004

Low Voltage Equipment Directive 2006/95/EC	
Safety Requirements	EN 61010-1: 2010 EN 61010-2-030: 2010

# INDEX

Accessories .....	12	overview .....	38
Automatic test		pass hold .....	55
add test .....	84	ramp up time .....	50
edit settings .....	83	results .....	68
load .....	81	running a test .....	64
page view .....	87	saving .....	63
results .....	94	special mode .....	76
running a test .....	90	sweep .....	76
saving .....	86	sweep graph .....	79
test file name .....	85	test filename .....	51
Caution symbol .....	5	test frequency .....	43
Cleaning the instrument .....	7	test function .....	41
Declaration of conformity .....	177	test limits .....	44
Dimensions .....	172, 173	test reference .....	46
Disposal instructions .....	7	test selection .....	36, 37, 39
EN61010		test settings .....	40
measurement category .....	6	test time .....	47
pollution degree .....	7	test voltage .....	42
Environment		timing diagrams .....	69
safety instruction .....	7	Marketing	
Error messages .....	163	contact .....	161
External control .....	105	Menu tree .....	32
Interlock key .....	111	Operating precautions .....	27
overview .....	106	Overview .....	10
remote operation .....	107	Package contents .....	14
remote terminal .....	106	Power on/off	
signal I/O operation .....	110	safety instruction .....	6
signal I/O overview .....	108	Rear panel diagram .....	19
FAQ .....	160	Remote control .....	112
Front panel diagram .....	15	Command list .....	120
GPIO installation .....	25	Command syntax .....	117
Ground		function check .....	115
symbol .....	5	interface configuration .....	113
Interlock key .....	111	Service operation	
Line voltage selection .....	23	about disassembly .....	6
List of features .....	11	contact .....	161
Manual tests		Specifications .....	166
ARC mode .....	52	Sweep function .....	76
fail mode .....	56	Test errors .....	164
ground mode .....	58	UK power cord .....	8
max hold .....	57	Utility settings	

buzzer.....	99	RS232.....	100
Control settings.....	102	start control.....	102
double action.....	102	USB.....	100
GPIB.....	100	Warning symbol.....	5
interface.....	100	Workplace precautions.....	26
key lock.....	102	Zeroing.....	73
LCD.....	98		