

User's Guide

EXTECH[®]

INSTRUMENTS

A FLIR COMPANY

RF EMF Strength Meter

Model 480846

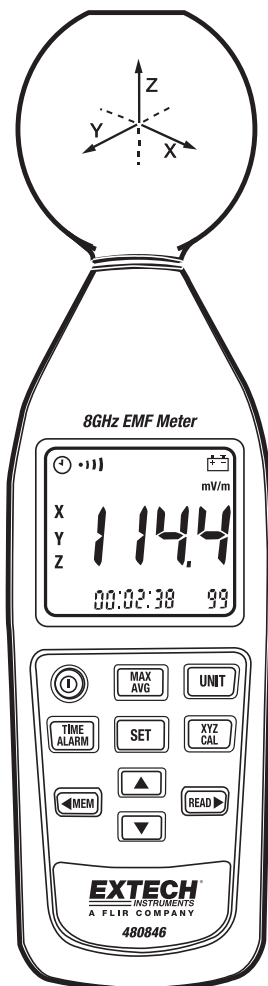

Safety Information



CAUTION

- Before making a measurement, check if the low battery symbol () is shown on the display when the meter is switched on. Replace the battery if the symbol is displayed.
- In the case of prolonged storage, it is preferable to remove the battery from the meter.
- Avoid shaking the meter, particularly in the measurement mode.
- The accuracy and function of the meter may be adversely affected by exceeding the specified limits as well as by improper handling.



DANGER!

- Use caution when working in the vicinity of powerful radiation sources.
- Persons with electronic implants (e.g. cardiac pacemakers) should avoid powerful radiation sources.
- Observe the local safety regulations.
- Observe the operating instructions for equipment that is used to generate or conduct electromagnetic energy.
- Be aware that secondary radiators (e.g. reflective objects such as a metallic fence) can cause a local amplification of the field.
- Be aware that the field strength in the near vicinity of radiators increases proportionally to the inverse cube of the distance. This means that enormous field strengths can result in the immediate vicinity of small radiation sources (e.g. leak in waveguides, inductive ovens).
- Field strength measuring devices can underrate pulsed signals, particularly with radar signals in which case significant measurement errors can arise.
- All field strength measuring devices have a limited specified frequency range. Fields with spectral components outside of this frequency range are generally incorrectly evaluated and tend to be underrated. Before using field strength measuring devices, you should thus be certain that all field components to be measured lie in the specified frequency range of the measuring device.

Introduction

This meter is a broadband device for monitoring high-frequency radiation in the range of **10MHz to 8GHz**. The non-directional electric field and high sensitivity also allow measurements of electric field strength in TEM cells and absorber rooms.

The unit of measurement and the measurement types are expressed in units of electrical and magnetic field strength and power density.

At high frequencies, the power density is of particular significance. It provides a measure of the power absorbed by a person exposed to the field. This power level must be kept as low as possible at high frequencies. The meter can be set to display the instantaneous value, the maximum value measured or the average value. Instantaneous and maximum value measurements are useful for orientation, e.g. when first entering an exposed area.

- 10MHz to 8 GHz Frequency range.
- For isotropic measurements of electromagnetic fields.
- Non-directional (isotropic) measurement with three-channel measurement sensor.
- High dynamic range due to three-channel digital processing.
- Configurable alarm threshold and memory function.

Fundamentals

▪ **Electromagnetic Radiation**

This meter is used to indicate radiated electromagnetic fields. Wherever there is a voltage or a current, electric (E) and magnetic (H) fields arise. Examples include the electromagnetic fields from radio broadcasting and TV transmitters.

▪ **Electric Field Strength**

This is a field vector quantity that represents the force (F) on an infinitesimal unit positive test charge (q) at a point divided by that charge. Electric field strength is expressed in units of volts per meter (V/m).

Use the units of electric field strength for measurements in the following situations:

- In the near-field area of the source.
- Where the nature of the electromagnetic field is unknown.

▪ **Magnetic field strength (H) :**

This is a field vector that is equal to the magnetic flux density divided by the permeability of the medium. Magnetic field strength is expressed in units of amperes per meter (A/m).

▪ **Power density (S) :**

Power per unit area in the direction of propagation, usually expressed in units of watts per square meter (W/m²) or, for convenience, units such as milliwatts per square centimeter (mW/cm²).

▪ **The characteristic of electromagnetic fields :**

Electromagnetic fields propagate as waves and travel at the speed of light (c). The wavelength is proportional to the frequency.

$$\lambda(\text{wavelength}) = \frac{c(\text{speed of light})}{f(\text{frequency})}$$

Near-field is assumed if the distance to the field source is less than three wavelengths. For far-fields, the distance is more than three wavelengths. In the near-field, the ratio of electric field strength (E) and magnetic field strength (H) is not constant, so measure each separately. In the far-field, however, it is enough to just measure one field quantity, and compute the other accordingly.

Description

Front Panel Description

(1). E-field sensor.

(2). LCD display.

(3). MAX/AVG

- Press this key to scroll through the following: "Instantaneous" → "Max. instantaneous" → "Average" → "Max. average".

(4) **⏻** key: Press this key to turn the meter on or off.

(5). UNIT

- Press this key to change the units: "mV/m or V/m" → "μA/m or mA/m" → "μW/m², mW/m² or W/m²" → "μW/cm² or mW/cm²".
- Press and hold this key while turning the meter on to disable the audible sound. The "🔊" symbol will disappear.

(6). TIME ALARM key:

- Press this key to display date and time.
- Press and hold this key while turning the meter ON to the alarm setting mode, press the SET key 2 times to exit this mode.
- Press this key for 3 seconds to switch alarm function On or Off.

(7). XYZ Cal key:

- Press this key to change the sensor axis: "All axis" → "X axis" → "Y axis" → "Z axis".
- Press and hold this key while turning the meter on to switch the device to the calibration factor setting mode, press SET key to exit this mode.

(8). SET key:

- Press this key to enter the current data and time setting mode. Press again to exit.

(9 - 12). **▲ ▼ ◀ ▶** keys : Used to set current date and time, datalogging interval time, alarm setting value, calibration factor setting value, or recall data.

(10). MEM key:



- Press this key one time to store one data set to memory.
- Press and hold this key while turning the meter on to enter the clear manually recorded data mode. Press SET key to exit this mode.

(11). READ key:

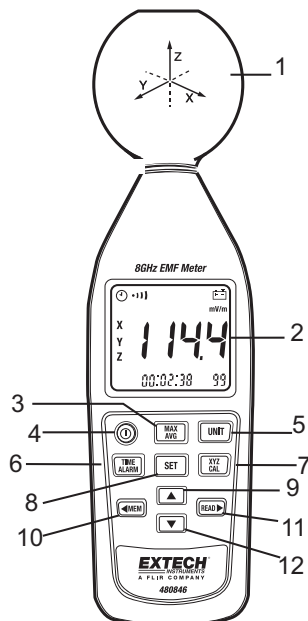
- Press this key to switch to the manual data reading mode. Press this key again to exit this mode.
- Press and hold this key while turning the meter on to disable the Auto Power OFF function. The "⏻" symbol will disappear



LCD display description

- (1).  : Auto power off function on / off.
- (2).  : Audible sound function on / off.
- (3). MAX: Maximum measured value displayed.
MAX AVG: Maximum average value displayed.
- (4). AVG: Average measured value displayed.
- (5).  : Low battery indication.
- (6). Units : mV/m and V/m : Electric field strength;
 $\mu\text{A/m}$ and mA/m : Magnetic field strength.;
 $\mu\text{W/m}^2$, mW/m^2 , W/m^2 , $\mu\text{W/cm}^2$ and mW/cm^2 :
Power density

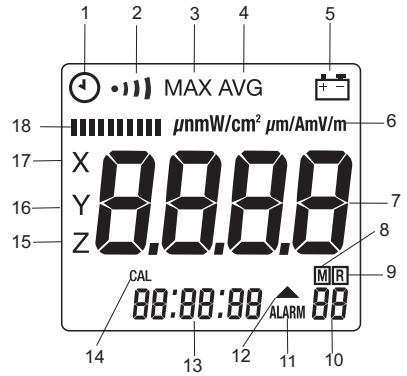

- (7). **0000** : Measured value displayed as per selected mode and selected units.
- (8). **M** : Stored measured value to memory indication.
- (9). **R** : Manual data memory mode indication.
- (10). **00** : Manual data memory address number (1~99).
- (11). ALM: Alarm function on / off or alarm setting indication.
- (12). \square : Displays when the alarm function is on and the instantaneous measured value exceeds the limit value indication.
- (13). **00:00:00** : hh : mm : ss Time displayed.
00/00/00 : YY : MM : DD Date displayed.
- (14). CAL : Calibration factor indication or setting indication (from 0.20 to 5.00).
- (15). Z : Z axis measured value displayed.
- (16). Y : Y axis measured value displayed.
- (17). X : X axis measured value displayed.
- (18). **|||||** : Analog bargraph of each axis (X,Y or Z) measured dynamic range indication for observing trends.

Operation

E-field sensors

The 3-channel sensor is located at the top of the meter. The three voltages generated by the sensor are fed back to the meter. In far-fields, an E-field sensor is preferable due to the greater bandwidth. The E-field sensor specific calibration accurate frequency ranges are 900MHz, 1800MHz, 2.7GHz, 3.5GHz and 8GHz. Other measurements can be made, for reference purposes only, using the entire range of 10MHz to 8GHz.

The meter is a small portable instrument that measures the electric field in the atmosphere of the sensor's surroundings. The measurement of the field is done by moving the aerial of the sensor in the desired measured environment.

A direct wide band measurement is obtained of the field that the measurement sensor is subjected to. To find the value of the field emitted by a source of interference, simply point the aerial towards it and get as close as possible (the value of the field is inversely proportional to the distance of the sensor/emission source). The operator must take care not to be between the source of disturbance and the zone to be checked. The human body shields electromagnetic fields. The E-field sensor is isotropic; it does not require special handling. It measures the field according to 3 axes without the aerial having to be moved in the 3 planes. Simply point it at the target to make the measurement.

Explanatory notes

Units of measurement

The meter measures the electrical component of the field; the default units are those of electrical field strength (mV/m, V/m). The meter converts the measurement values to the other units of measurement, i.e. the corresponding magnetic field strength units ($\mu\text{A/m}$, mA/m) and power density units ($\mu\text{W/m}^2$, mW/m², W/m², $\mu\text{W/cm}^2$ or mW/cm²) using the standard far-field formulae for electromagnetic radiation. The conversion is invalid for near-field measurements, as there is no generally valid relationship between electrical and magnetic field strength in this situation. Always use the default units of the sensor when making near-field measurements.

Result modes

The bar graph display always shows each axis (X, Y or Z) the instantaneous measured dynamic range value. The digit display shows the measurement according to one of four selectable modes:

- **Instantaneous:** The display shows the last value measured by the sensor, no symbol is displayed.
- **Maximum instantaneous (MAX):** The digital display shows the highest instantaneous value measured, the "MAX" symbol is displayed.
- **Average (AVG):** The digital display shows the average value measured, the "AVG" symbol is displayed.
- **Maximum average (MAX AVG):** The digital display shows the highest average value measured, the "MAX AVG" symbol is displayed.

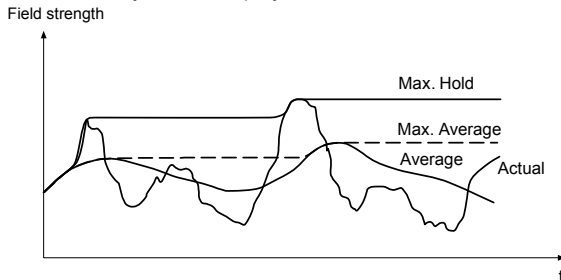

Alarm Limit Value (ALARM)

The alarm limit value is used to monitor the display value automatically. It controls alarm indication function. The alarm limit value can be edited in the display V/m unit.

NOTE: Alarm Limit Function is only used for total three axial value comparator.

Setting the units of measurement

Press the UNIT key to step through the units display.

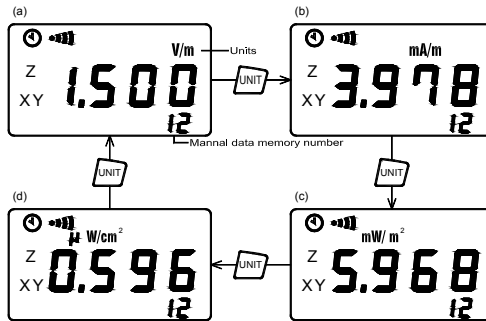

- (a). Electric field strength (V/m).
- (b). Computed magnetic field strength (mA/m).
- (c). Computed power density (mW/m²).
- (d). Computed power density (µW/cm²).

Setting the result mode

Instantaneous result mode is automatically set when the meter is turned on.

Press the MAX/AVG key to step through the results displays:

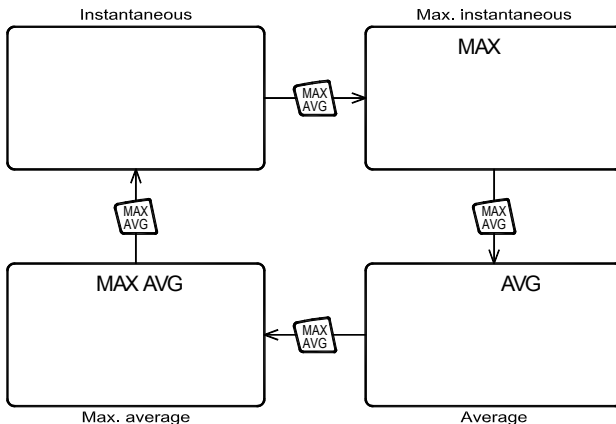

Setting the alarm limit value (ALM)

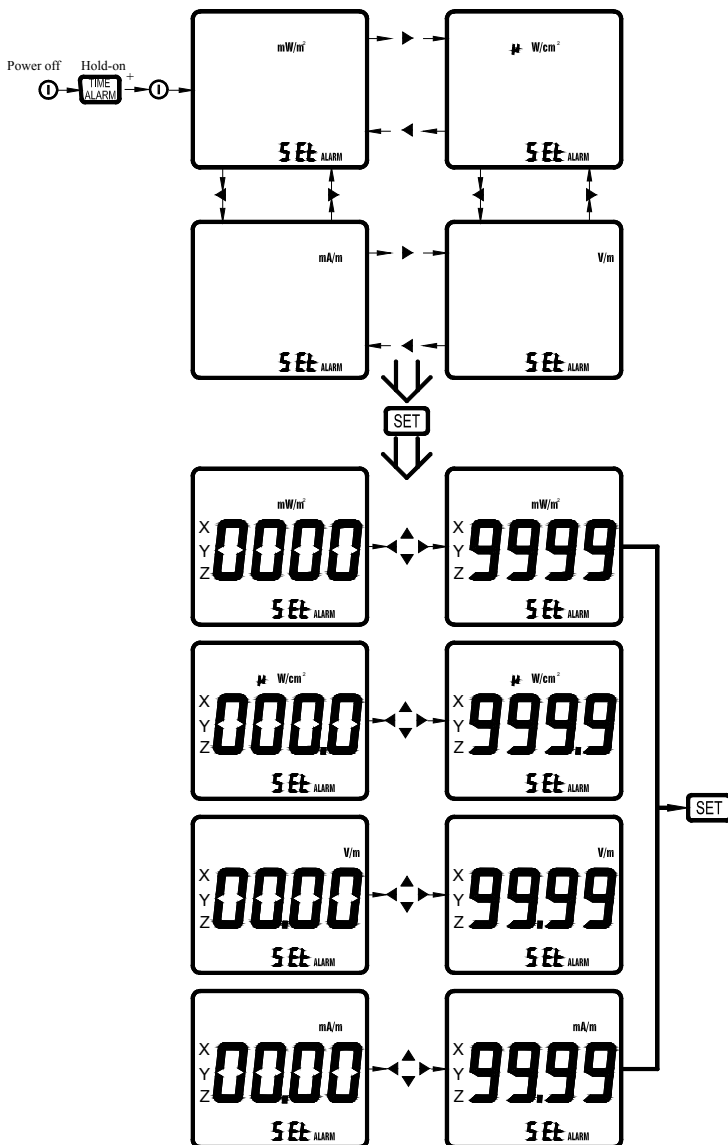



1. Press **1** key to turn off the meter.
2. Press and hold the **TIME ALARM** key, then press **1** key to turn on the meter, the display then shows "ALM" and "▲" (The Alarm setting mode). The four flashing digits can now be changed.
3. Press **▼** or **▲** key to increase or decrease the value.
4. Press **SET** to store the new setting value and exit.

Setting the alarm function on or off

1. Press **ALARM** key for 2 seconds to switch the alarm function on or off. The “ALM” and “” symbols in the display indicates that the alarm function is on.
2. When the alarm function is on, the display will show “▲” if the instantaneous measured value exceed the limit value.



Setting the audible sound function off

When the meter is normally turned on, the audible sound function is on.

1. Press  key to turn off the meter.
2. Press and hold **MAX/AVG** key and turn on the meter again to disable the audible sound, the “” symbol will disappear from the display.

Setting the auto power off function off

When the meter is normally turned on, the auto power off function is on.

1. Press  key to turn off the meter.
2. Press and hold **READ** key and turn on the meter again to disable the auto power off function; the “” symbol will disappear from the display.

Making measurements

Important:

If the sensor is moved quickly, excessive field strength values will be displayed which do not reflect the actual field conditions. This effect is caused by electrostatic charges.

Recommendation:

Hold the meter steady during the measurement.

Short-term measurements

Application:

Use either the "Instantaneous" or the "Max. Instantaneous" mode if the characteristics and orientation of the field are unknown when entering an area exposed to electromagnetic radiation.

Procedure

1. Hold the meter at arm's length.
2. Make several measurements at various locations around the work place or the interested areas as described above. This is particularly important if the field conditions are unknown.
3. Pay special attention to measuring the neighboring vicinity for possible radiation sources. Apart from active sources, those components connected to a source may also act as radiators. For example, the cables used in diathermy equipment may also radiate electromagnetic energy. Note that metallic objects within the field may locally concentrate or amplify the field from a distant source.

Long-term exposure measurements

Location:

Place the meter between yourself and the suspected source of radiation. Make measurements at those points where parts of your body are nearest to the source of radiation.

Note: Use the "Average" or "Max average" modes only when the instantaneous measurement values are fluctuating greatly.

Alarm function

Use this feature in the "Instantaneous", "Max. Instantaneous", "Average" or "Max. Average" modes.

When the instantaneous measured value exceeds the limit value, a sequence of warning beeps will sound.

Data memory

The meter includes a non-volatile data memory that can store a maximum of 99 measured values.

Storing individual measured values

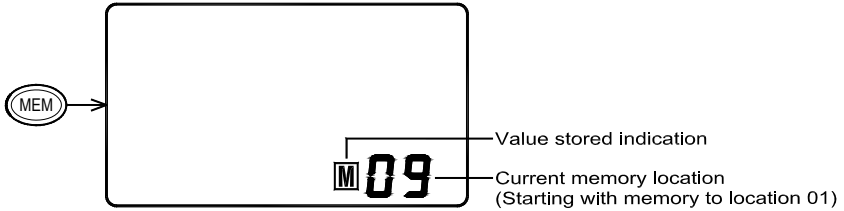

The current memory location number appears in the lower right small display.

Once you press the **MEM** key, it will store a displayed value and increment the memory location by one. Each flash of the "M" symbol display indicates one reading has been stored. When the memory location number shows "99", to indicate the manual data memory is full, the user must clear the entire contents of the data memory before storing new values.



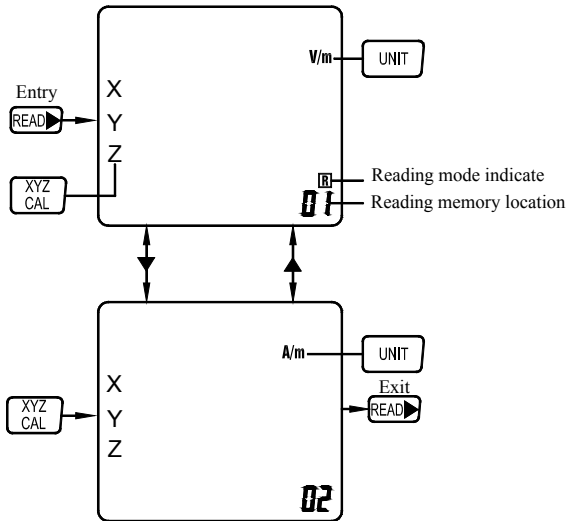

Reading individual measured values







1. Press **READ** key, the display shows "R" (reading mode).
2. Press **▼** or **▲** key to select the desired memory location.
3. Press the **UNIT** key to select the desired reading units.
4. Press the **XYZ/CAL** key to select the desired sensor axis reading.
5. Press the **READ** **▶** key to exit.

Deleting stored values

Once the memory is full, the entire contents of the memory can be cleared.

1. Press  to turn off the meter.
2. Press and hold MEM and turn on the meter again; the display will show:
“” and “”.
3. Press  to select “**YES**”.
4. Press SET to clear memory and exit.

Setting Current Data and Time

1. Press the **SET** key to enter this mode, the “SET” mark is displayed.
2. Press  or  key to move flashing two digit to desired setting position “hh:mm:ss” or “YY/MM/DD”.
3. Press  or  keys to set the current time “hh:mm:ss” and current date “YY/MM/DD”.
4. Press the **SET** key to store setting value and exit.

Calibration Factor (CAL)

The Calibration factor (CAL) provides a means to improve the accuracy of the results display by calibrating against the output of a known frequency generator. The field strength value measured is multiplied by the value of CAL that has been entered and the resulting value is displayed. The CAL setting range is from 0.20 to 5.00. The measurement accuracy will be sufficient for most applications even if the frequency response of the sensor calibration factor is ignored and the CAL is set to 1.00 in at all points.

Setting the calibration factor (CAL)

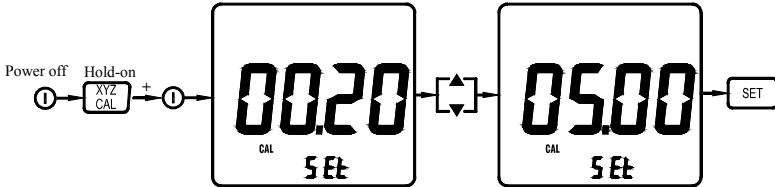

When the meter is normally turned on, the calibration factor set value will display for 2 seconds.

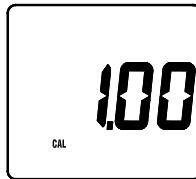

1. Press ⓘ key to turn off the meter.
2. Press and hold on the **XYZ/CAL** key, then press ⓘ key to turn on the meter to enter the calibration factor setting mode, the “CAL SET” marks is displayed.
3. Press ▲ or ▼ key to increase or decrease the value.
4. Press the **SET** key to store the new setting value and exit.

E-Field Typical Calibration Data:

Frequency	CAL	Frequency	CAL
50MHz	2.13	900 MHz	1.40
100MHz	1.37	1.8GHz	2.06
200 MHz	1.19	2.4GHz	0.66
300 MHz	0.69	3.5GHz	1.05
433 MHz	0.78	5.4GHz	2.20
500 MHz	1.38	8.0GHz	3.16
600 MHz	2.12		
700 MHz	1.66		
800 MHz	1.40		

Battery Installation and Replacement

Battery Installation

Remove the rear battery cover and insert a fresh 9V battery.

Battery Replacement

When the battery voltage drops below the operating voltage, the battery icon  appears and flashes. If it appears, the battery should be replaced.

You, as the end user, are legally bound (**Battery ordinance**) to return all used batteries and accumulators; **disposal in the household garbage is prohibited!**



You can hand over your used batteries / accumulators at collection points in your community or wherever batteries / accumulators are sold!

Disposal: Follow the valid legal stipulations in respect of the disposal of the device at the end of its lifecycle

Specifications

General Specifications

Measurement method:	Digital, triaxial measurement.
Directional characteristic:	Isotropic, triaxial.
Measurement range selection:	One continuous range.
Display resolution:	0.1mV/m, 0.1 μ A/m, 0.1 μ W/m ² , 0.001 μ W/cm ²
Setting time: T	Typically 1s (0 to 90% of measurement value).
Display refresh rate:	Typically 0.5 seconds
Display type:	Liquid-crystal display (LCD), 4 digit.
Audible alarm:	Buzzer.
Units:	mV/m, V/m, μ A/m, mA/m, μ W/m ² , mW/m ² , W/m ² μ W/cm ² , mW/cm ²
Display value:	Instantaneous measured value, maximum value, or maximum average value.
Alarm function:	Adjustable threshold with ON/OFF.
Data memory and read storage:	99 data sets.
Dry batteries:	9V NEDA 1604/1604A
Battery life: >	3 hours
Auto power off:	5 minutes.
Operating temperature range:	0°C to +50°C
Operating humidity range:	25% to 75%RH
Storage temperature range:	-10°C to +60°C
Storage humidity range:	0% to 80%RH
Dimensions:	Approx. 67(W) \times 60(T) \times 247(L)mm.
Weight (including battery):	Approx. 250g

Electrical Specifications

Unless otherwise stated, the specifications hold under the following conditions:

- The meter is located in the far-field of a source, the sensor head is pointed towards the source.
- Ambient temperature: +23C±3C
- Relative air humidity: 25% to 75%

Sensor type: Electrical field (E)
Frequency range: 900MHz, 1800MHz, 2.7GHz, 3.5GHz and 8GHz
(measurements can be made, for reference purposes only, using the entire range of 10MHz to 8GHz)

Specified measurement range:

CW signal (f > 900MHz): 20mV/m to 108.0V/m
53µA/m to 286.4mA/m
1µW/m² to 30.93W/m²
0µW/cm² to 3.093mW/cm²

Dynamic range: Typically 75dB

Absolute error at 1 V/m & 900 MHz: ±1.0dB

Frequency response:

Sensor (with typical CAL factors): ±1.0dB (50MHz to 1.9GHz)
±2.4dB (1.9GHz to 8GHz)

Isotropy deviation: Typically ±1.0dB (f>900MHz)

Overload limit: 10.61mW/cm² (200V/m)

Thermal response (0 to 50°): ±0.5dB

Copyright © 2012 Extech Instruments Corporation (a FLIR company)

All rights reserved including the right of reproduction in whole or in part in any form.
www.extech.com