

## BN 56

Hexagon head screws  
fully threaded

DIN 933  
ISO 4017  
~UNI 5739

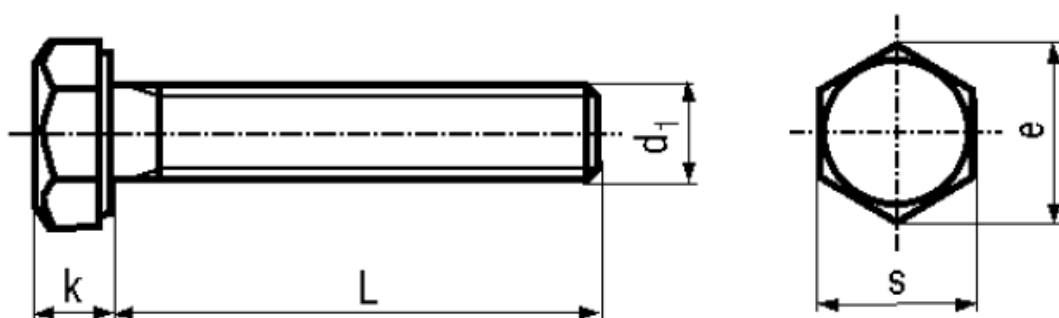

Material	<b>Steel</b>	Tensile strength	<b>800 N/mm<sup>2</sup></b>
Surface	<b>zinc plated blue</b>	Proof stress 0,2%	<b>640 N/mm<sup>2</sup></b>
Quality	<b>8.8</b>	Elongation after fracture	<b>min. 12%</b>

### Article No. - 1049186

d <sub>1</sub>	M5
L	6
e	8,79
k	3,5
s	8

DIN 933: Standard withdrawn  
M10, M12, M14, M22; Wrench size according to ISO 272.