

BN 56

Hexagon head screws
fully threaded

DIN 933
ISO 4017
~UNI 5739

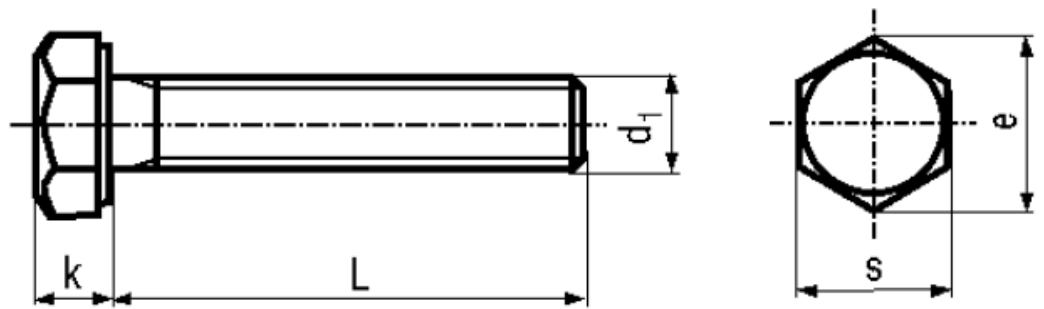

Material	Steel	Tensile strength	800 N/mm²
Surface	zinc plated blue	Proof stress 0,2%	640 N/mm²
Quality	8.8	Elongation after fracture	min. 12%

Article No. - 1049313

d ₁	M5
L	45
e	8,79
k	3,5
s	8

DIN 933: Standard withdrawn
M10, M12, M14, M22; Wrench size according to ISO 272.