

BN 357

Slotted flat countersunk head screws

DIN 963 A
~ISO 2009
~UNI 6109

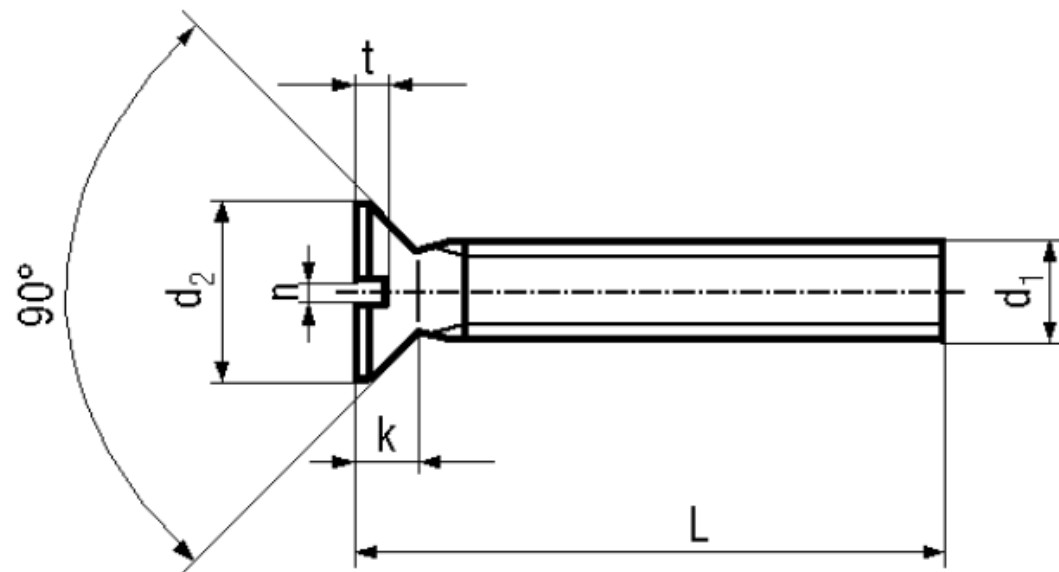

Material	Steel	Tensile strength	400 N/mm²
Surface	zinc plated blue	Elongation after fracture	min. 14%
Quality	4.8		

Article No. - 1140531

d ₁	M4
L	5
d ₂ max.	7,5
k max.	2,2
n	1
t min.	0,8

DIN 963 A: Standard withdrawn
All lengths fully threaded.