

BN 4851

Hexalobular socket flat countersunk head screws

ISO 14581

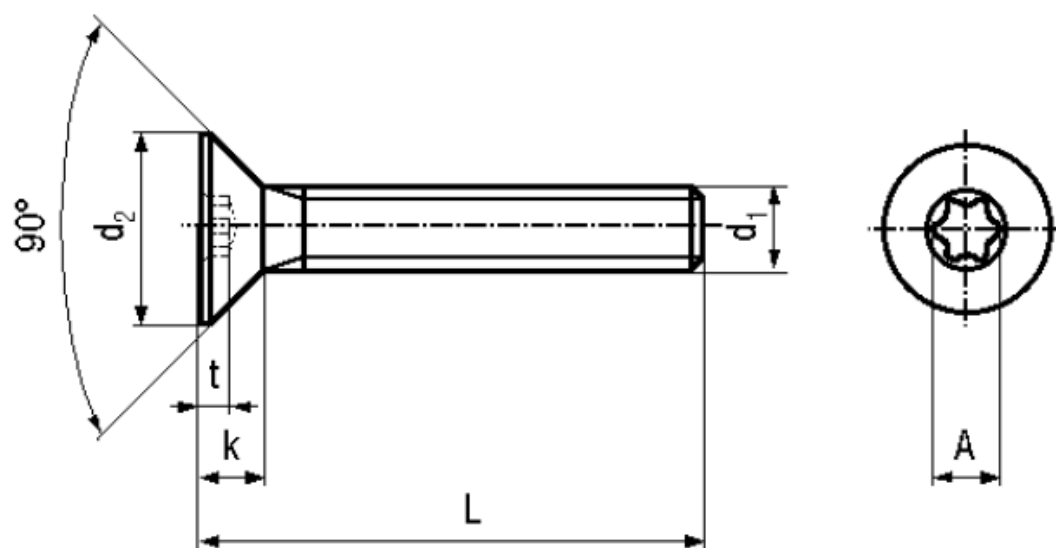

Material	Steel	Quality	08.8 / 8.8
Surface	zinc plated blue		

Article No. - 1146270

d ₁	M3
L	8
d ₂ max.	5,5
k max.	1,65
c	X10
t max.	0,83
A~	2,8