

## BN 272

Hexagon socket head cap screws  
fully threaded  
fully threaded

DIN 912  
ISO 4762

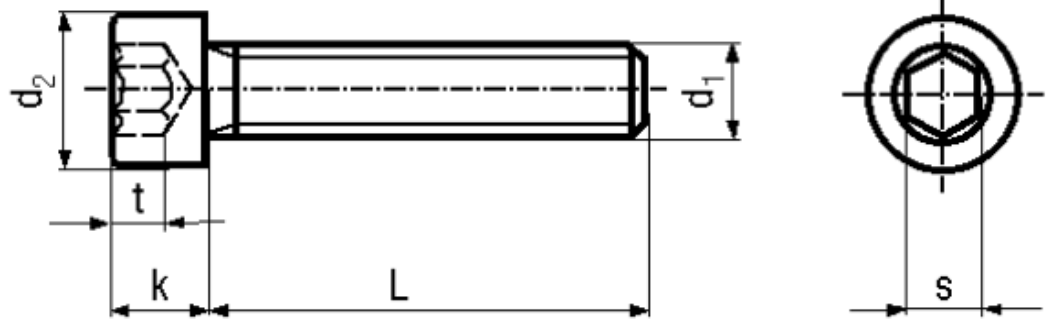

Material	Steel	Tensile strength	800 N/mm <sup>2</sup>
Surface	black	Proof stress 0,2%	640 N/mm <sup>2</sup>
Quality	8.8	Elongation after fracture	min. 12%

### Article No. - 1000039

d <sub>1</sub>	M3
L	8
d <sub>2</sub>	5,5
k	3
s	2,5
t min.	1,3

DIN 912: Standard withdrawn