

BN 622

Hexagon head screws
fully threaded

DIN 933
ISO 4017
~UNI 5739

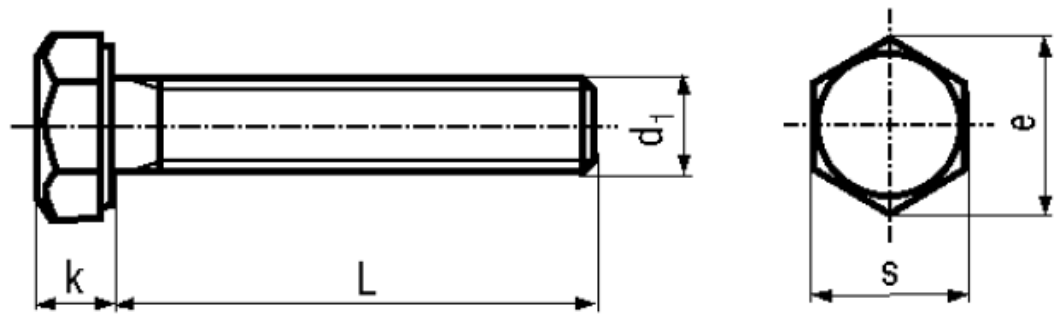

Material	Stainless steel	Quality	A2
----------	------------------------	---------	-----------

Article No. - 1238183

d ₁	M10
L	40
e	18,9
k	6,4
s	17

DIN 933: Standard withdrawn

Hex cap locking screws eco-fix®: BN 5951

WAF's according to ISO on request.

The current property class on the market is class 70 in A2-70 / A4-70 (tensile strenght 700 N/mm²).