

Technical data sheet

Connection thread sealing ring, metric

Art.-Nr. 2030032

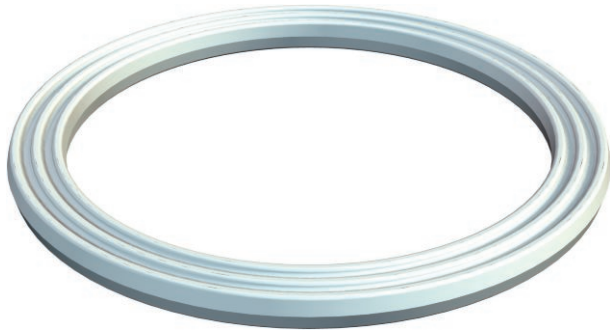

Connection thread sealing ring, suitable for all plastic cable glands with metric connection thread to DIN EN 60423 or ISO 68. The internal diameters of the sealing rings are designed in such a way that they can be pre-mounted in a captive manner.



PE Polyethylene

Master data

Item No.	2030032
Type	107 F M63 PE
Description 1	Connection thread sealing ring
Dimension	M63
Material	Polyethylene
Material symbol	PE
Smallest sales unit	100,00 pcs
Weight	0,29 kg/100 pcs.

Technical specifications

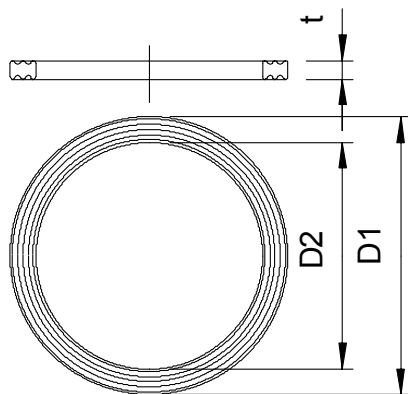

Dimension D1	73,80 mm
Dimension D2	63,00 mm
Dimension t	2,00 mm
Version	Flat sealing ring
External diameter	73,80 mm
Inner diameter	63,00 mm
For thread dimension, metric	63,00
Size	M63 mm
Thickness	2,00 mm