

# Technical data sheet

## Connection thread sealing ring, metric

Art.-Nr. 2030028

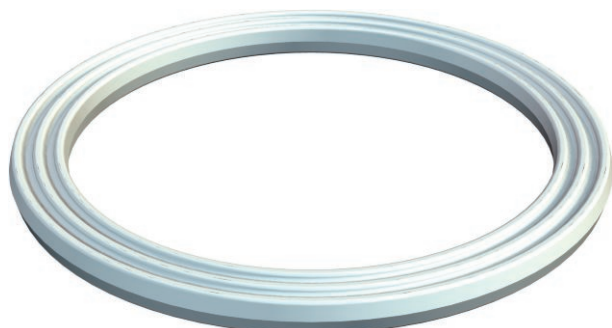

Connection thread sealing ring, suitable for all plastic cable glands with metric connection thread to DIN EN 60423 or ISO 68. The internal diameters of the sealing rings are designed in such a way that they can be pre-mounted in a captive manner.



**PE** Polyethylene

### Master data

Item No.	2030028
Type	107 F M50 PE
Description 1	Connection thread sealing ring
Dimension	M50
Material	Polyethylene
Material symbol	PE
Smallest sales unit	100,00 pcs
Weight	0,25 kg/100 pcs.

### Technical specifications

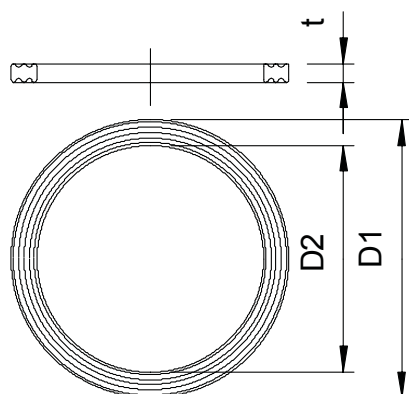

Dimension D1	60,10 mm
Dimension D2	50,00 mm
Dimension t	2,00 mm
Version	Flat sealing ring
External diameter	60,10 mm
Inner diameter	50,00 mm
For thread dimension, metric	50,00
Size	M50 mm
Thickness	2,00 mm