

Technical data sheet

Connection thread sealing ring, metric

Art.-Nr. 2030012



Connection thread sealing ring, suitable for all plastic cable glands with metric connection thread to DIN EN 60423 or ISO 68. The internal diameters of the sealing rings are designed in such a way that they can be pre-mounted in a captive manner.



PE Polyethylene

Master data

Item No.	2030012
Type	107 F M20 PE
Description 1	Connection thread sealing ring
Dimension	M20
Material	Polyethylene
Material symbol	PE
Smallest sales unit	100,00 pcs
Weight	0,03 kg/100 pcs.

Technical specifications

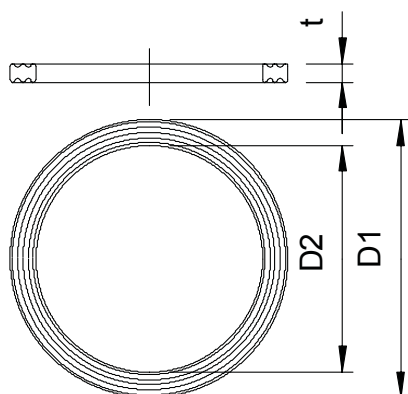

Dimension D1	25,10 mm
Dimension D2	20,00 mm
Dimension t	1,10 mm
Version	Flat sealing ring
External diameter	25,10 mm
Inner diameter	20,00 mm
For thread dimension, metric	20,00
Size	M20 mm
Thickness	1,10 mm