

BN 2724 - DIN 7500 C

Cross recessed pan head thread forming screws
type C, Pozidriv Z, metric thread
case-hardened

DIN 7500 C
~UNI 8112

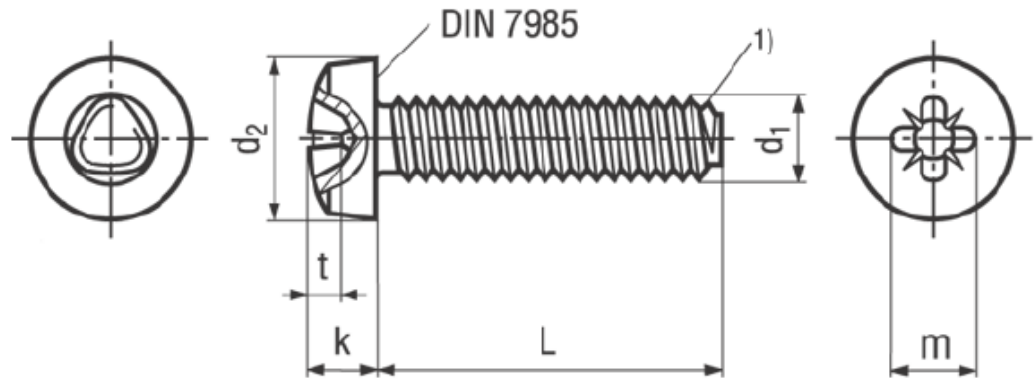

Material	Steel	Hardness	450-550 HV
Surface	zinc plated blue		

Article No. - 1473700	
d ₁	M3
L	10
d ₂ max.	6
k max.	2,52
Pozidriv	1
m~	3
t min.	1,68
t max.	1,93

Tapered thread end max. 4P

Screwdriver Bits 1/4": BN 31514 and BN 31516 / CG 1

Fasteners steel case-hardened with electroplated coatings: Susceptible to hydrogen embrittlement!