

BN 14066 - DIN 7982 C - ~ISO 7050

Cross recessed flat countersunk head tapping screws
 Pozidriv Z, with cone end type C
 case-hardened

DIN 7982 C
 ~ISO 7050
 ~UNI 6955AB

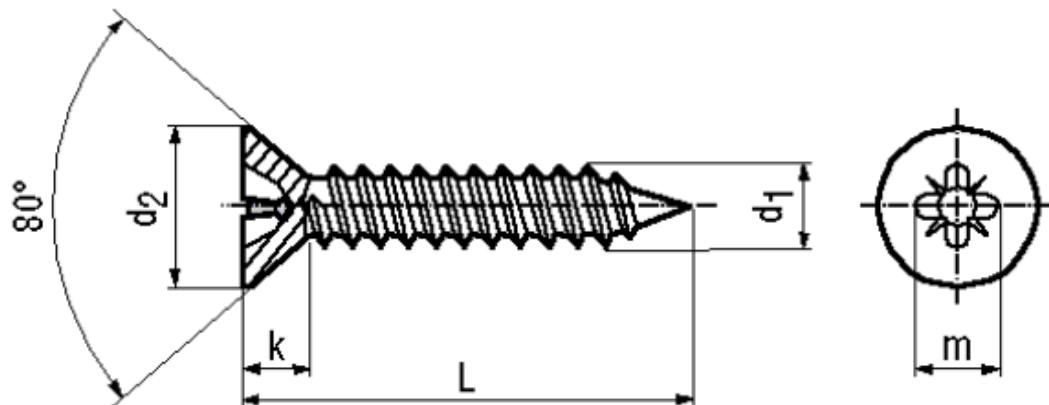

Material	Steel	Hardness	450 HV
Surface	zinc plated blue		

Article No. - 2098318	
d ₁	ST 2,9
L	6,5
d ₂ max.	5,5
k~	1,7
Pozidriv	1
m~	2,8

DIN 7982: Standard withdrawn

Countersink must be designed according to the corresponding standard!

Screwdriver Bits 1/4": BN 31514 and BN 31516 / CG 1

Fasteners steel case-hardened ≥ 320 HV with electroplated coatings: Susceptible to hydrogen embrittlement!