

BN 584 - DIN 125 A - ~ISO 7089

Flat washers
without chamfer
punched

DIN 125 A
~ISO 7089
~UNI 6592

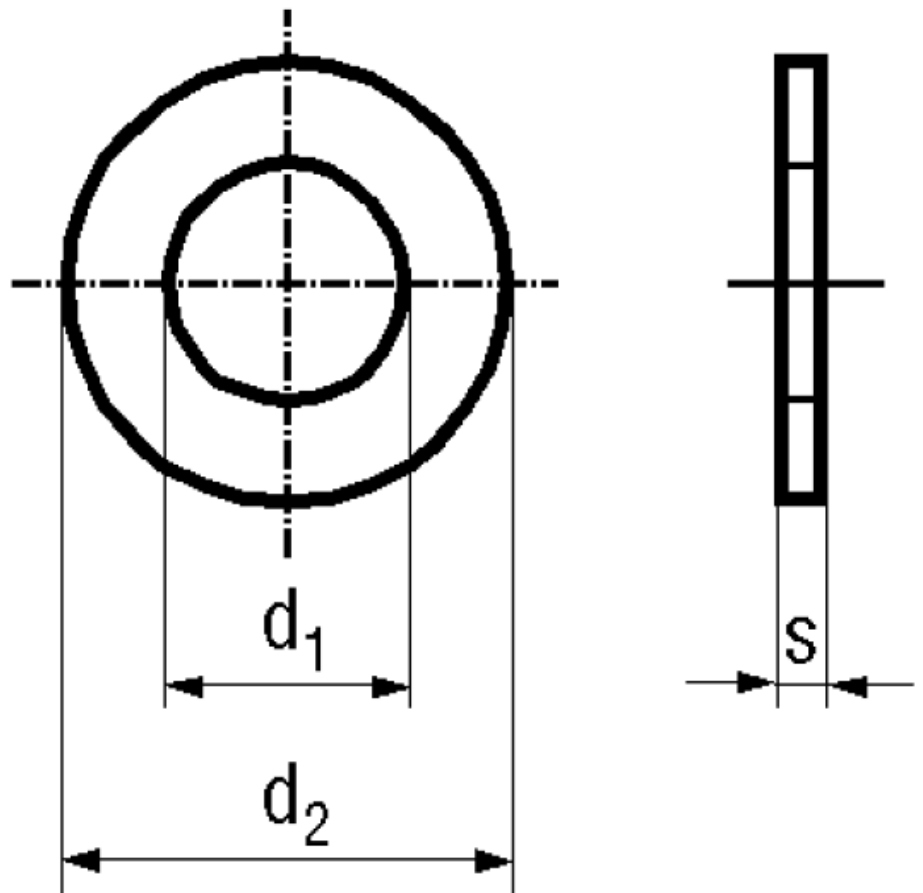

Material Surface

Article No. - 1761587	
fit for	M8
d_1	8,4
d_2	16
s	1,6

DIN 125: Standard withdrawn