

BN 1684 - DIN 9021 - ~ISO 7093

Flat washers
without chamfer

DIN 9021
~ISO 7093
~UNI 6593

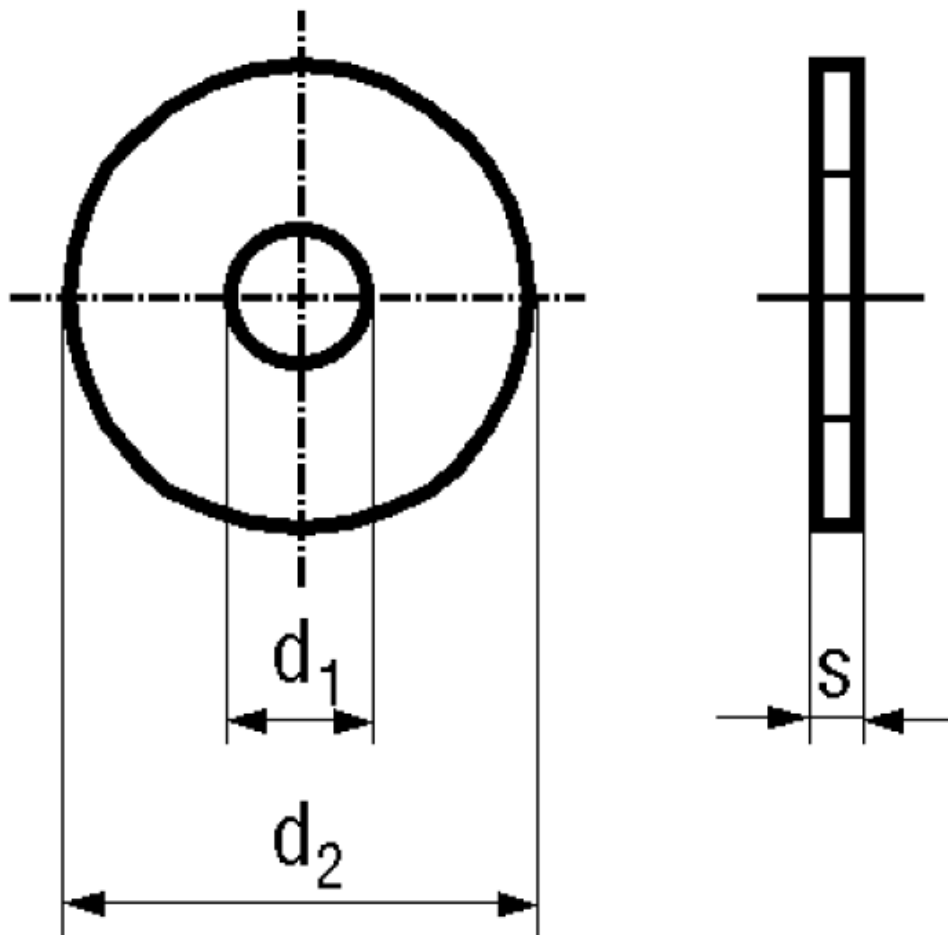

Material	Stainless steel	Hardness	140HV
Quality	A4		

Article No. - 1397079

fit for	M6
d_1	6,4
d_2	18
s	1,6