

BN 1356 - DIN 9021 - ~ISO 7093

Flat washers
without chamfer

DIN 9021
~ISO 7093
~UNI 6593

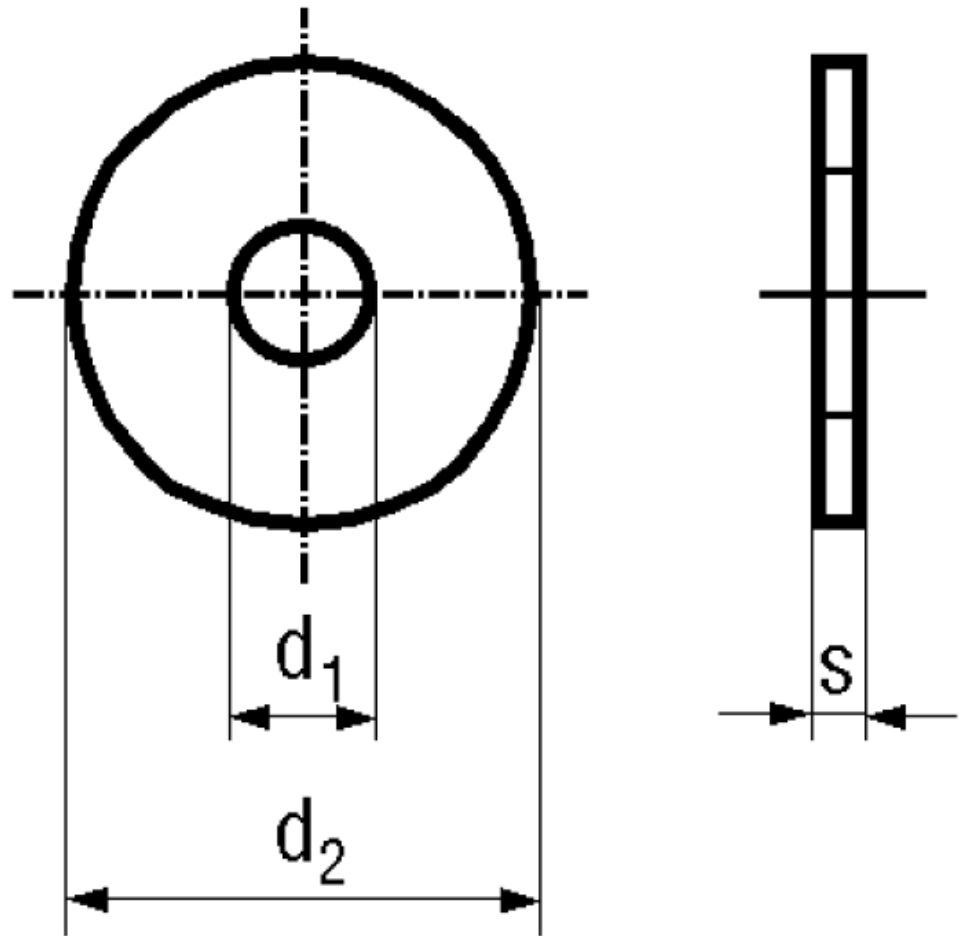

Material	Stainless steel	Hardness	140 HV
Quality	A2	Hardness grade	140 HV

Article No. - 1117157	
fit for	M6
d_1	6,4
d_2	18
s	1,6

DIN 9021: Standard withdrawn