

BN 584 - DIN 125 A - ~ISO 7089

Flat washers
without chamfer
punched

DIN 125 A
~ISO 7089
~UNI 6592

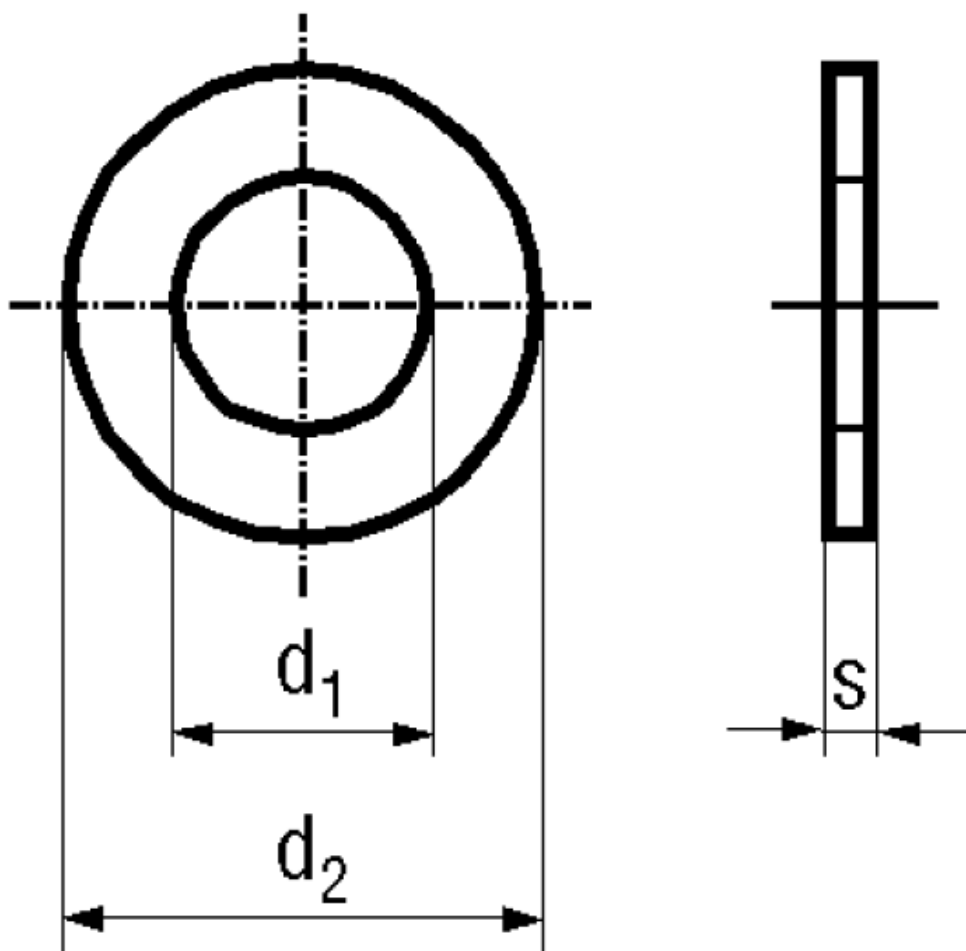

Material Surface

Article No. - 1226827	
fit for	M5
d_1	5,3
d_2	10
s	1

DIN 125: Standard withdrawn