

BN 1374 - DIN 6796

Conical spring washers
for fastening joints

DIN 6796
~UNI 8836

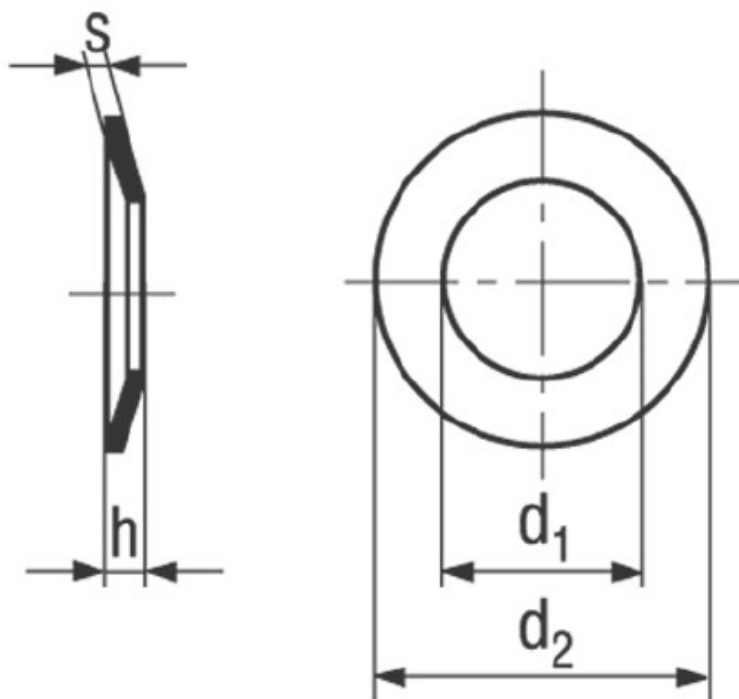

Material	Spring steel	Hardness	420-510 HV
Surface	phosphated		

Article No. - 1144936	
for thread	M5
d_1	5,3
d_2	11
h min.	1,35
h max.	1,55
s	1,2