

BN 1976 - DIN 988

Shim rings
lubricated

DIN 988

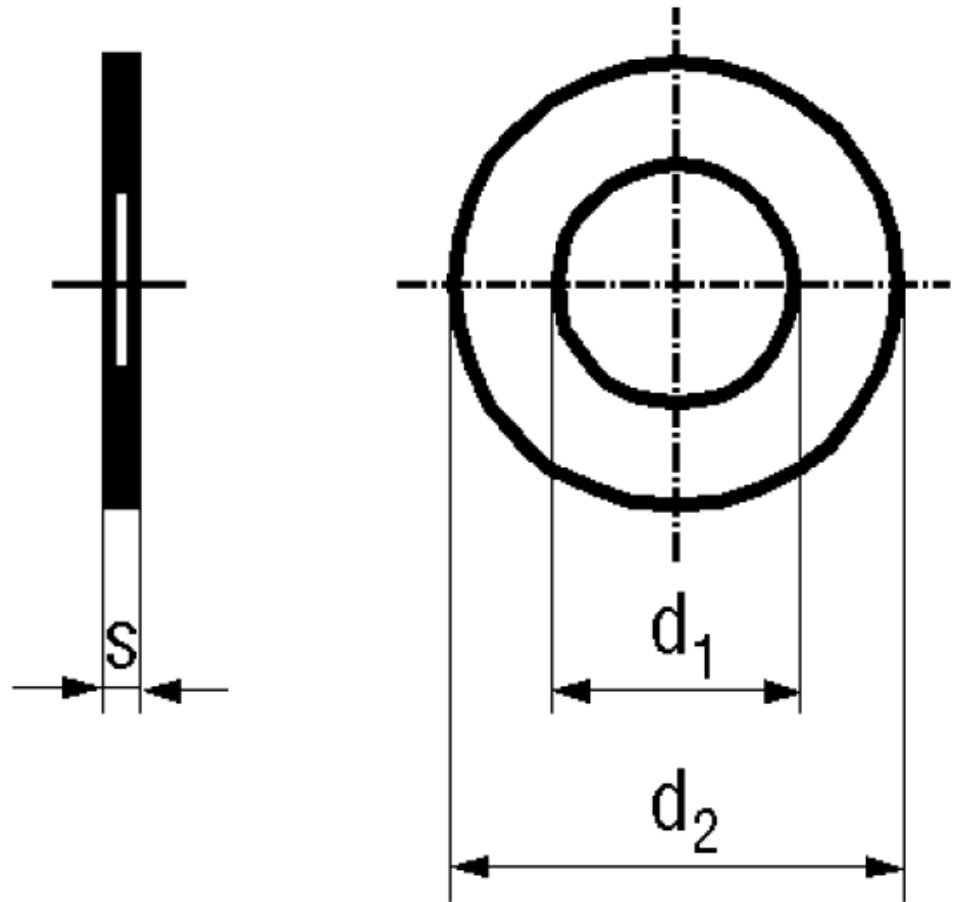

Material	Steel	Quality	St 2 K50
Surface	plain	Hardness grade	St 2K50

Article No. - 1225413	
d ₁	5
d ₂	10
s	0,3