

BN 717 - DIN 125 A - ~ISO 7089

Flat washers
without chamfer

DIN 125 A
~ISO 7089
VSM 13904
~UNI 6592

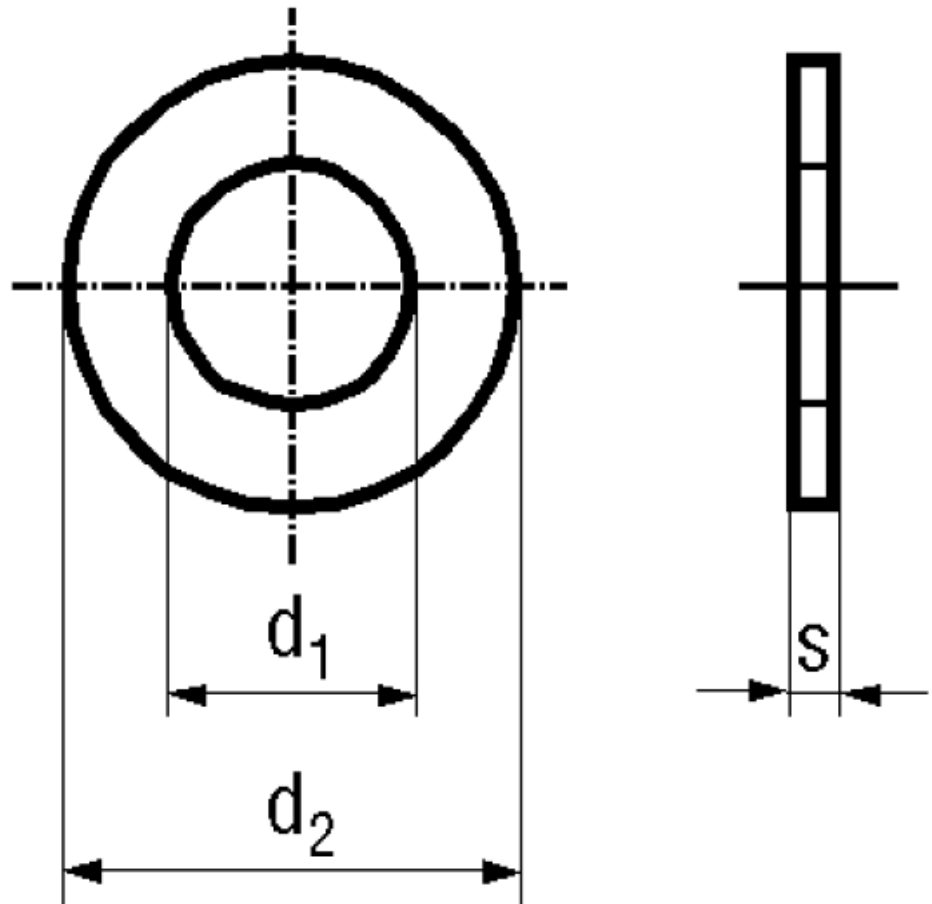

Material	Steel	Hardness grade	140 HV
Surface	zinc plated yellow		

Article No. - 1268015

for thread	M4
d_1	4,3
d_2	9
s	0,8