

BN 672 - DIN 127 B

Helical spring lock washers with flat end

DIN 127 B
~UNI 1751 B

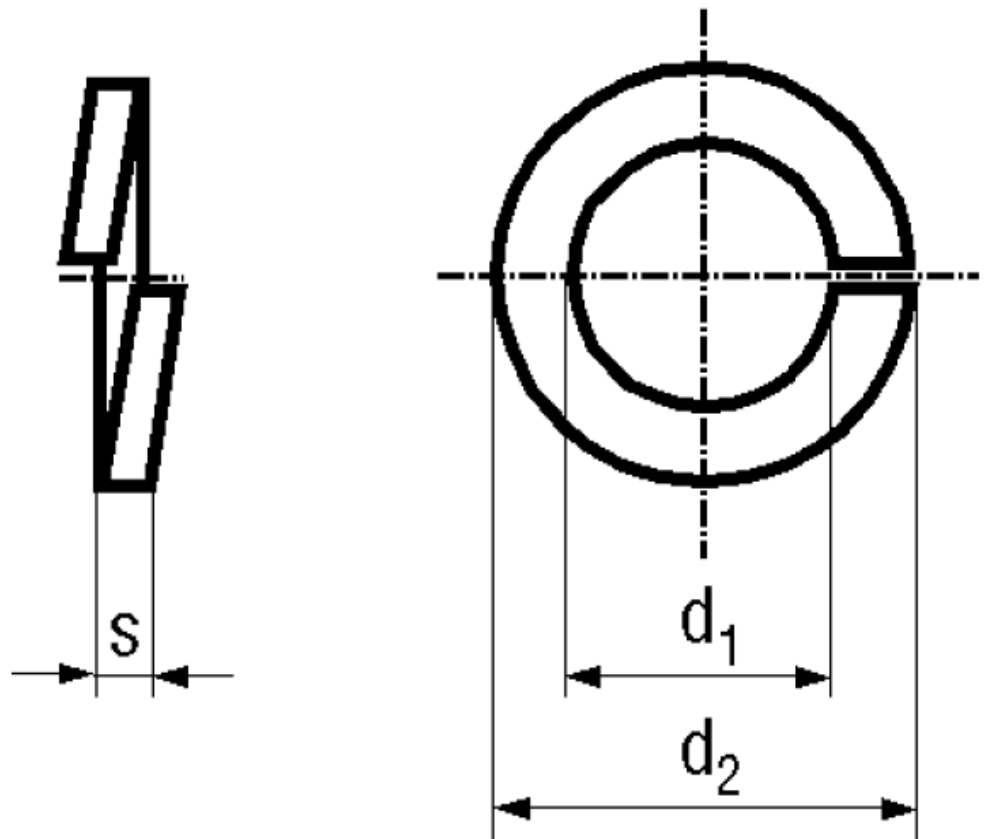

Material	Stainless steel	Quality	A2 / 1.4310
----------	-----------------	---------	-------------

Article No. - 1253581

for thread	M4
d ₁ min.	4,1
d ₁ max.	4,4
d ₂ max.	7,6
s	0,9

DIN 127: Standard withdrawn.

Material: A2 / 1.4310 at manufacturer's option.

We recommend DIN 128 A (curved spring lock washers) for new constructions: BN 674 / BN 8856.