

## BN 584 - DIN 125 A - ~ISO 7089

Flat washers  
without chamfer  
punched

DIN 125 A  
~ISO 7089  
~UNI 6592

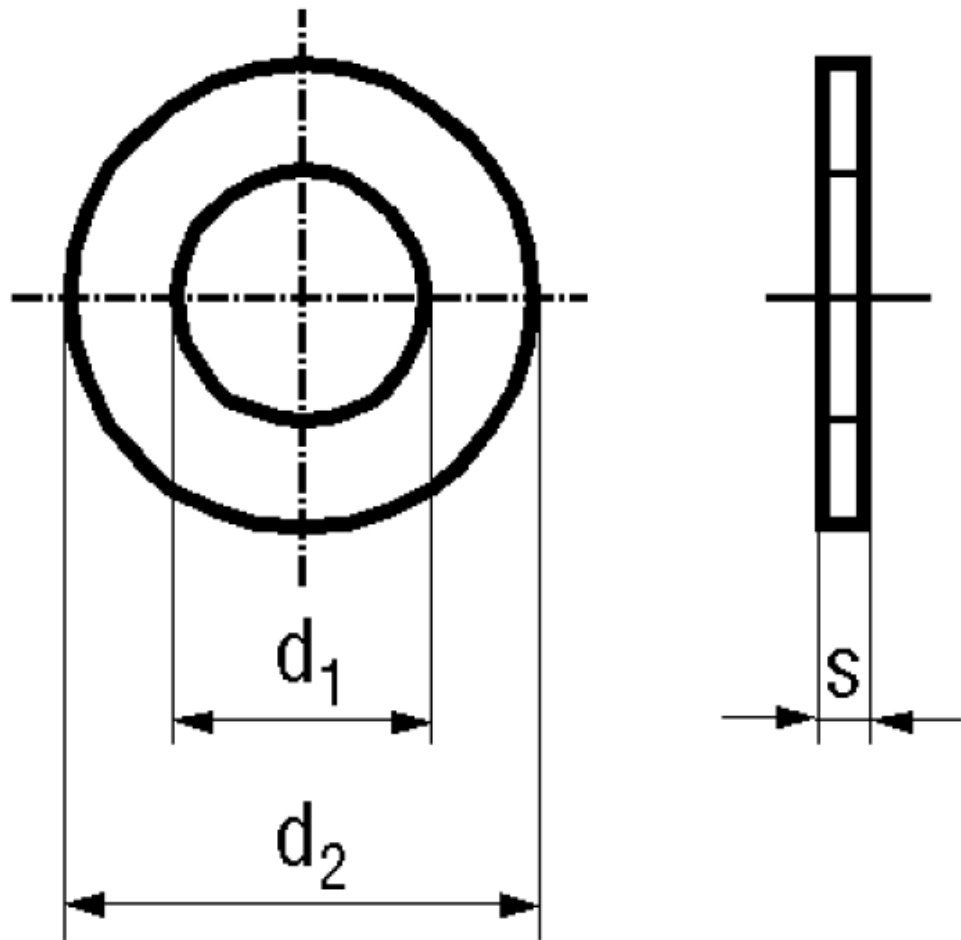

Material  Surface

Article No. - 1226819	
fit for	M4
$d_1$	4,3
$d_2$	9
$s$	0,8

DIN 125: Standard withdrawn