

## BN 1976 - DIN 988

Shim rings  
lubricated

DIN 988

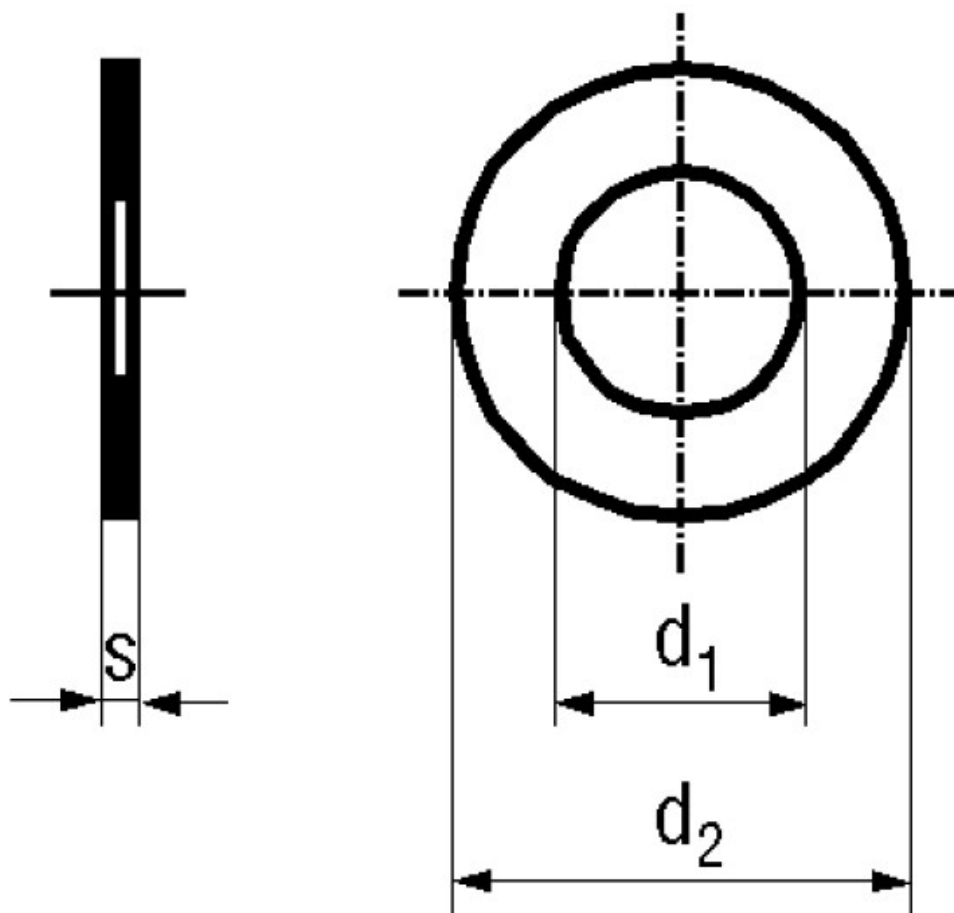

Material	Steel	Quality	St 2 K50
Surface	plain	Hardness grade	St 2K50

Article No. - 1225367

d <sub>1</sub>	4
d <sub>2</sub>	8
s	0,2