

BN 726 - DIN 433 - ~ISO 7092

Flat washers
without chamfer, for screws with
cylindrical head

DIN 433
~ISO 7092

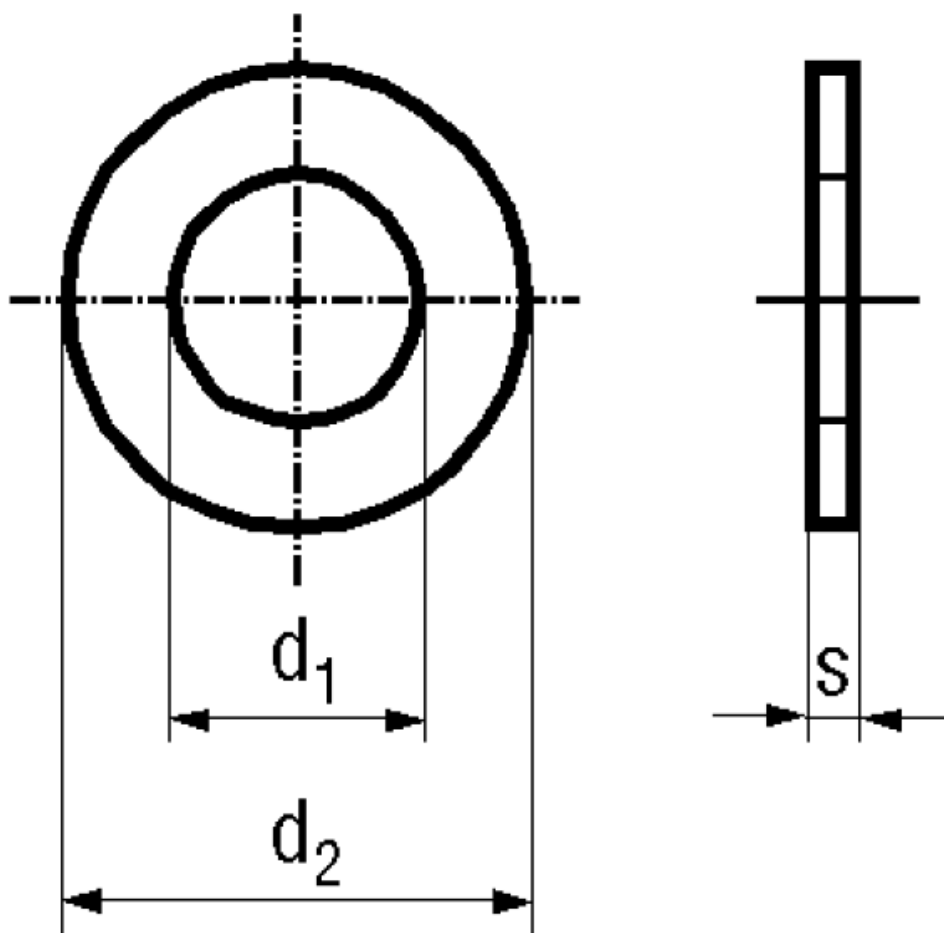

Material	Steel	Hardness grade	140 HV
Surface	zinc plated blue		

Article No. - 1269534

for thread	M2,5
d_1	2,7
d_2	5
s	0,5

DIN 433: Standard withdrawn

M 1; M 1,2; M 1,4; M 18: Not included in ISO 7092