

627-2RSH

SKF Explorer

Dimensions

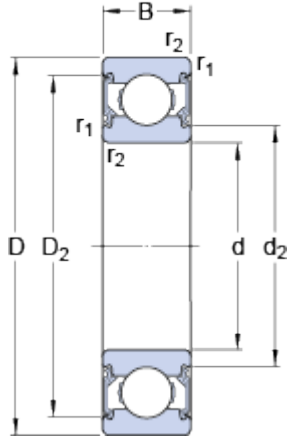

d	7	mm
D	22	mm
B	7	mm
d ₂	10.55	mm
D ₂	19.2	mm
r _{1,2}	min. 0.3	mm

Abutment dimensions

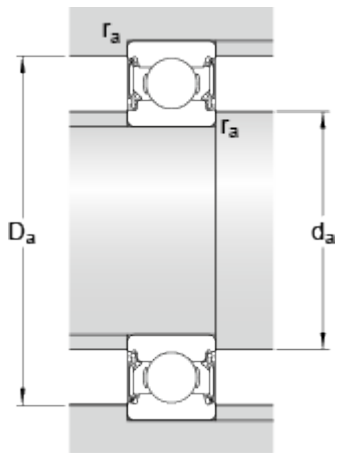

d _a	min. 9.4	mm
d _a	max. 10.5	mm
D _a	max. 19.6	mm
r _a	max. 0.3	mm

Calculation data

Basic dynamic load rating	C	3.4	kN
Basic static load rating	C ₀	1.4	kN
Fatigue load limit	P _u	0.057	kN
Limiting speed		22000	r/min
Calculation factor	k _r	0.025	
Calculation factor	f ₀	12	

Mass

Mass bearing	0.0126	kg
--------------	--------	----