

6205-2Z

SKF Explorer

Dimensions



d	25	mm
D	52	mm
B	15	mm
d ₁	34.35	mm
D ₂	46.21	mm
r _{1,2}	min. 1	mm

Abutment dimensions

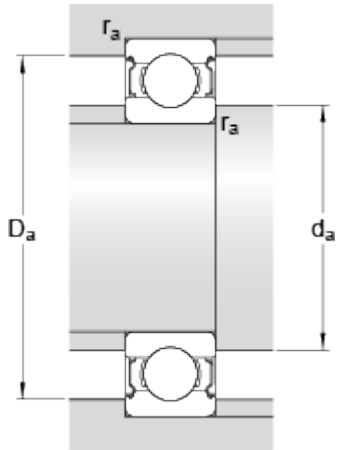

d _a	min. 30.6	mm
d _a	max. 34.3	mm
D _a	max. 46.4	mm
r _a	max. 1	mm

Calculation data

Basic dynamic load rating	C	14.8	kN
Basic static load rating	C ₀	7.8	kN
Fatigue load limit	P _u	0.335	kN
Reference speed		28000	r/min
Limiting speed		14000	r/min
Calculation factor	k _r	0.025	
Calculation factor	f ₀	14	

Mass

Mass bearing	0.132	kg
--------------	-------	----

