

607-2RSH

SKF Explorer

Dimensions

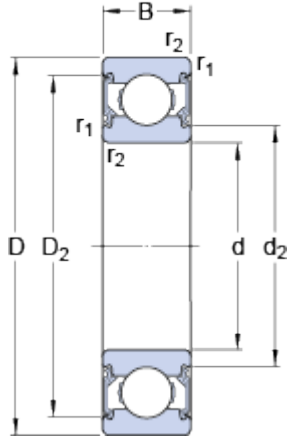

d	7	mm
D	19	mm
B	6	mm
d ₂	9.5	mm
D ₂	16.5	mm
r _{1,2}	min. 0.3	mm

Abutment dimensions

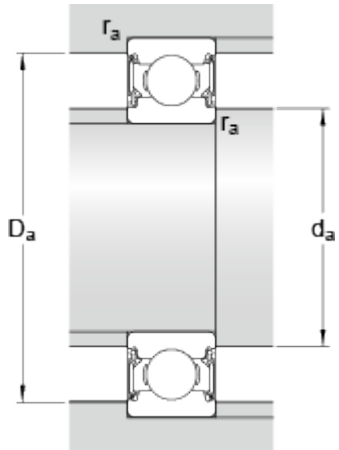

d _a	min. 9	mm
d _a	max. 9.4	mm
D _a	max. 17	mm
r _a	max. 0.3	mm

Calculation data

Basic dynamic load rating	C	2.3	kN
Basic static load rating	C ₀	0.95	kN
Fatigue load limit	P _u	0.04	kN
Limiting speed		24000	r/min
Calculation factor	k _r	0.025	
Calculation factor	f ₀	13	

Mass

Mass bearing	0.0078	kg
--------------	--------	----