

6302 - 2 Z

SKF Explorer

Dimensions

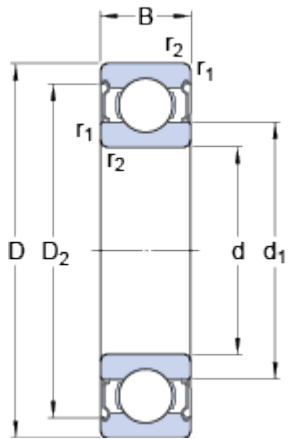

d	15	mm
D	42	mm
B	13	mm
d ₁	≈ 23.7	mm
D ₂	≈ 36.23	mm
r _{1,2}	min. 1	mm

Abutment dimensions

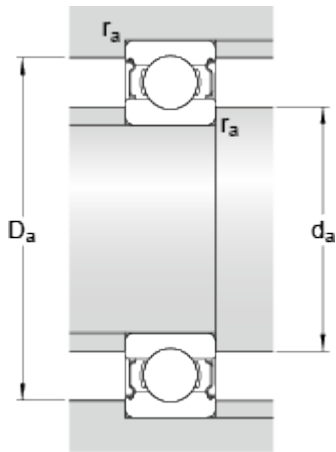

d _a	min. 20.6	mm
d _a	max. 23.6	mm
D _a	max. 36.4	mm
r _a	max. 1	mm

Calculation data

Basic dynamic load rating	C	11.9	kN
Basic static load rating	C ₀	5.4	kN
Fatigue load limit	P _u	0.228	kN
Reference speed		38000	r/min
Limiting speed		19000	r/min
Calculation factor	k _r	0.03	
Calculation factor	f ₀	12	

Mass

Mass bearing	0.086	kg
--------------	--------------	----

